



2018 RAM PROMASTER



RAM
COMMERCIAL



SMART WAY TO GO.

HUGE CAPABILITY, AND ENGINEERED FOR ECONOMIES ACROSS THE BOARD. Meet the 2018 Ram ProMaster®: a versatile yet supremely comfortable commercial vehicle that's all about supplying the performance and flexibility you need.



Equipped with a wealth of top-tier features, Ram ProMaster Cargo Van invites countless upfit possibilities, supplying **best-in-class**^{1*} **standard cargo height**, **best-in-class**¹ **maximum cargo width**, **best-in-class**¹ **width between the wheel wells** and **best-in-class**¹ **turning diameter**[†]—due in part from the **class-exclusive**¹ **front-wheel drive**. The final touch for all ProMaster models makes another powerful statement: the Pentastar® V6 gives you **best-in-class**¹ **standard V6 horsepower of 280 hp** backed with 260 lb-ft of torque. Payload capacity is just as robust: up to 4,440 lb, with towing reaching up to 5,100 lb[†].

In the final analysis, here's why this van stands out—and frequently stands above: three distinctive models. Three wheelbase lengths. Two roof heights. Four body lengths that include extended body versions. **Best of all, the Mopar® Upfit Center can help transform your Cargo Van with your ideal upfit**—and it's only blocks from the actual factory. For more, visit us at RAMTRUCKS.COM/PROMASTER

*A note about this brochure: all disclaimers and disclosures can be found on page 25. †When properly equipped.

THE REAL LOW-DOWN: WE'RE BEST-IN-CLASS.



5 YR / 60,000 MI
POWERTRAIN LIMITED WARRANTY³



BEST-IN-CLASS¹ LOAD FLOOR HEIGHT

LOWEST STEP-IN HEIGHT JOINS A FOCUS ON LOW COST OF OWNERSHIP. NO WONDER THIS WORKS SO WELL.

Obviously, a van of this quality and size makes the ideal delivery vehicle. Fortunately, Ram ProMaster[®] is much more than what meets the eye. Designed for low costs of ownership and operation, take the necessity of oil changes as one built-in advantage: Ram ProMaster can run up to 10,000 miles between oil changes, giving you the very real possibility of as few as ten changes over 100,000 miles of operation; it's engineering that delivers measurable savings. Expanding or trading in? Resale value is notable. Keeping it for the long term? Count on a 10-Year Corrosion Protection Warranty. Pinpointing trailer hitches and loading docks? The indispensable ParkView[®] Rear Back-Up Camera³ is now standard. Finally, this powertrain delivers both confidence and reliability, in the form of a 5-Year/60,000-Mile Powertrain Limited Warranty.² For more, visit us at RAMTRUCKS.COM/PROMASTER

Properly secure all cargo.



**MULTIPLE CHOICES.
NOW PUT YOURS TO
THE TEST.**

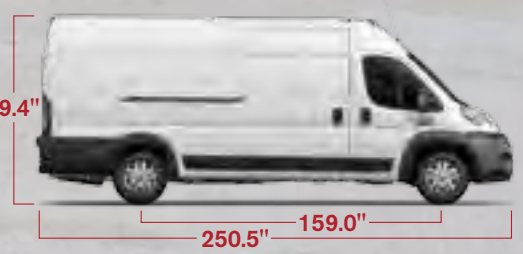
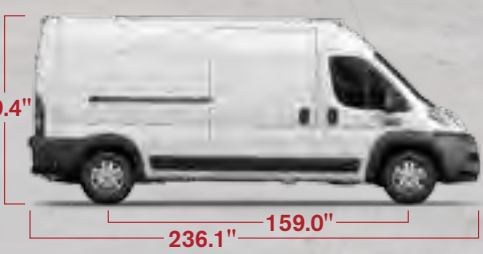
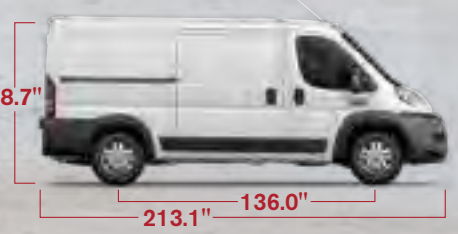
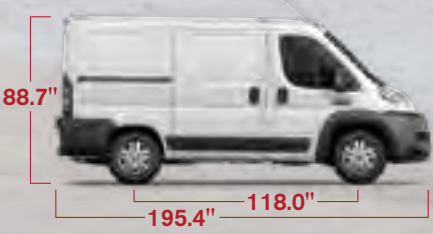

SUPERIOR CARGO ROOM IS DEFINED BY THIS VOLUME.



Properly secure all cargo.

STANDARD ROOF

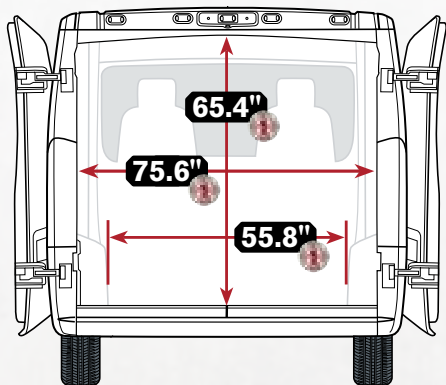

LOAD FLOOR HEIGHT **21.0"**

CARGO AREA* (MAX. CUBIC FEET) .. **303.7**

*Meets SAE J1100 requirements.

HIGH ROOF

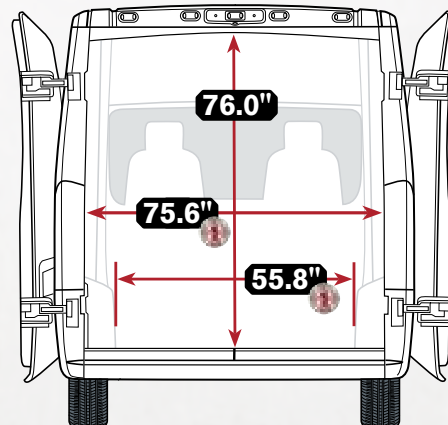

LOAD FLOOR HEIGHT **21.0"**

CARGO AREA* (MAX. CUBIC FEET) .. **462.8**

*Meets SAE J1100 requirements.



IF YOU'VE GOT A DESTINATION IN MIND, YOUR FIRST MOVE IS TO THE HEAD OF THE CLASS. This Cargo Van stands out by delivering top-tier commercial capability—and it's all by the numbers. Namely, first-place. Whether you're utilizing this capacious space for deliveries or a mobile workshop, the **best-in-class¹ standard cargo height** assures total convenience. More? Ram ProMaster® delivers. The available High Roof lets tall workers up to 6'3" stand without stooping. And thanks to two more class-ruling features—**best-in-class¹ maximum cargo width** and **best-in-class¹ cargo width between the wheel wells**—your custom shelving can extend from inside wall to wheel-well lip, creating a wider aisleway when equipped with that custom shelving. (We invite you to compare; we rigorously adhere to SAE J1100 protocols that compel manufacturers to measure volume and width with rigid restrictions; the results are realistic numbers that max out at 462.8 cubic feet of totally usable volume.) Now take that vast interior space, and consider the upfit-inviting treatments both inside and out: nearly vertical side walls, flat and low load floor (with an equally practical super-low step-in height) and the available assets of the High Roof and the extended body version. Access all of this through side-sliding and rear cargo doors designed for success; they're all large enough to accommodate a standard pallet.



Properly secure all cargo.

PAYLOAD UP TO 4,440 LB. BRING ON THE HEAVY PALLETS.

CARGO VAN PAYLOADS <small>(weights given in lb)</small>	CARGO VAN*						
	1500			2500		3500	
	118" WB	136" WB		136" WB	159" WB	159" WB	159" WB, EXT.
	STANDARD ROOF	STANDARD ROOF	HIGH ROOF	HIGH ROOF		HIGH ROOF	
MAX PAYLOAD GAS ENGINE	4,000	3,900	3,770	4,140	4,020	4,440	4,340

*Max payload based on body model, GVWR class. Specifications subject to change. See dealer for most up-to-date information. WB = wheelbase.

CHASSIS CAB PAYLOADS <small>(weights given in lb)</small>	CHASSIS CAB†			CUTAWAY†		
	3500			3500		
	136" WB	159" WB	159" WB, EXTENDED	136" WB	159" WB	159" WB, EXTENDED
	81.1" CA	104.1" CA	104.1" CA	81.1" CA	104.1" CA	104.1" CA
MAX PAYLOAD GAS ENGINE	5,180	5,140	5,110	5,240	5,210	5,160

†Max payload based on body model, GVWR class. Specifications subject to change. See dealer for most up-to-date information. WB = wheelbase. CA = cab-to-axle.



THE MOBILE WORKSHOP: YOU DESIGN. WE BUILD.

THE CAVERNOUS INTERIOR OF CARGO VAN reflects an intelligently designed space you'll make better through a wide variety of upfits and options—many of which will come directly from Mopar® and your Ram ProMaster® dealer.

What makes Ram ProMaster Cargo Van the prime candidate for an upfit? Multiple reasons. Dash-to-front-axle lengths are kept short to maximize interior volume. Side walls flirt with a practical 90 degrees, enabling easy installation of shelving. Side doors (up to 49.2 inches wide) and rear doors (61.5 inches wide, up to 70.5 inches high and opening to 260 degrees) are huge; both accommodate standard-size pallets. Three wheelbases and four workable lengths (that max out with the extended version reaching 250.5 inches) supply abundant space and a work-ready floor length.

BEST-IN-CLASS ASSETS ABOUND. Roof height depends on model: for Cargo Van, the Standard Roof delivers a **best-in-class¹ standard cargo height of 65.4 inches**; the available High Roof measures up: it's a very convenient 76 inches high. Cargo Van also features the **lowest load floor height in the class¹**—step-in height comes in at an easy-in 21 inches, eliminating the need for an intermediate step. Further assets: **best-in-class¹ cargo width between the wheel wells** and a **best-in-class¹ turning diameter**; on 118-inch wheelbase models, it's a street-friendly 36.3 feet. Maneuverability and handling are exemplary. Front-wheel drive lowers the platform and dispenses with the characteristic "hump" typical of rear-wheel-drive vehicles.



PARTITIONS OPEN UP MORE POSSIBILITY. The standard layout gives you unimpeded access to the rear cargo area from the front. When greater privacy or security is needed, we've engineered two solutions: the solid partition and the partition with sliding window are constructed of steel, and both fit flush with the surrounding flat floor, the side panel and the roof interfaces. The rear-facing side is painted White, while the cab side of the wall is covered with sound-deadening material to provide a comfortable front cabin. It's a working combination of aesthetics and functionality.

Properly secure all cargo.



CHASSIS CAB AND CUTAWAY. STRENGTHS YOU'LL BUILD ON.

WE'LL GIVE YOU A TOUGH-AS-NAILS FOUNDATION. NOW THE GOOD PART IS UP TO YOU. The wind-tunnel-tested aerodynamic cab is sculpted art, and the chassis that supports it is industrial-grade from the get-go. With the recent addition of a wider and beefier rear axle, Ram ProMaster® Chassis Cab/Cutaway models offer a robust GCWR, upfit-ready architecture and remarkable capability.

Here's what supports upfits and businesses alike: the super-low frame height of only 24.4 inches from the ground enables easy access without a step, reduces the ramp angle to a minimum (to facilitate attachments) and creates nearly unlimited upfit potential. These 3500 weight class workhorses come in 136- and 159-inch wheelbases; maximum overall length of 244.4 inches. GVWR is rated at 9,350 lb; towing is rated up to 5,100 lb.*

Payload varies by wheelbase, but maxes out at a no-nonsense 5,240 lb. Standard suspension—specifically designed for these trucks—is a premium heavy-duty design with a MacPherson strut front unit and rear heavy-duty stabilizer bar. In the final analysis, whether you're building a custom camper or resilient service body, it works. From vocation to vacation, Ram ProMaster is ready to take it on. Get more at RAMTRUCKS.COM/PROMASTER



Illustrated to show Cutaway.

*When properly equipped. Shown with aftermarket upfit. Properly secure all cargo.



NIMBLE. AGILE. RESPONSIVE.

FRONT-WHEEL DRIVE. HOLDS THE CENTER LINE. AND HELPS BOOST YOUR BOTTOM LINE.

This Ram ProMaster® exclusive¹ feature offers multiple benefits. Front-wheel drive ensures outstanding road manners in snowy and icy conditions. It helps lower the step-in height—a welcome convenience when loading and unloading. And because it helps reduce overall vehicle weight, front-wheel drive also contributes to your overall fuel efficiency.



RAM PROMASTER[®]: A GUIDE TO COMPLETE CAPABILITY.



BEST-IN-CLASS¹ TURNING DIAMETER

Most don't expect unprecedented performance attributes from an industrial-grade commercial vehicle—and one of our early aims was to shatter that expectation. Take the basics—steering and braking. Ram ProMaster models employ a premium steering gear that enhances drive quality and reliability; more to the point, the engineering helps contribute to a phenomenally tight turning diameter—and it's a **best-in-class¹ 36.3 feet** on our 118-inch wheelbase models. At all four corners are **high-performance Brembo[®] brakes**, providing outstanding stopping power during both everyday driving scenarios and, most notably, when trailering.

36.3-FT
TURNING
DIAMETER

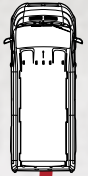

WE PUNISHED IT BRUTALLY. AND STILL, IT DID EVERYTHING RIGHT.

We know exactly how to achieve durability, reliability and unimpeachable quality: subject these models to almost absurd levels of punishment through unrelenting testing. We conducted pre- and post-production testing on roads and in conditions that ranged from the arctic -40°F of northern Sweden to the scorching 125°F heat of Nevadan deserts. Ram ProMaster surpassed with flying colors—solid proof that your ProMaster will perform under ever-changing loads and widely varying climates.



BEST-IN-CLASS¹ LOWEST LOAD FLOOR HEIGHT

The class-exclusive¹ front-wheel drive lets us employ an ingenious rear suspension: a light yet robust beam axle/leaf spring design that's equally as tough as those found on rear-wheel-drive vehicles. Engineering that dispenses with the bothersome "hump" inherent in rear-wheel-drive vehicles gives you a load floor with a **best-in-class¹ lowest load floor height of only 21 inches.**



Properly secure all cargo.



CLASS-EXCLUSIVE¹ FRONT-WHEEL DRIVE (FWD)

A more complete story of the exclusive FWD appears on the previous spread—but there still remain several crucial advantages. Not only does FWD add a little more weight to the front end (ensuring phenomenal front tire "grab" on the road) it also dispenses with the fore-to-aft drivetrain employed by our competitors—a contribution to the **best-in-class¹ lowest load floor height.**

EXTRA MEASURES FOR CONVENIENCE AND SAFETY

Now standard on Cargo Van, the **ParkView[®] Rear Back-Up Camera³** is high-mounted for optimal views. Automatically engaging in Reverse, it displays the rear scene on the Uconnect[®] 3 with 5-inch display radio screen. The on-screen grid lines enhance the ease of backing up, while the view—even with rear doors open—helps boost the safety factor. The available **ParkSense[®] Rear Park Assist System³** is activated by engaging Reverse. It operates below 8 mph, using audible warnings to alert the driver of obstacles to the rear.

TOP-LEVEL CARGO MANAGEMENT

We fully expect you to maximize your Ram ProMaster[®]—and to expand your carrying capability. Cargo Vans offer **roof strength to handle up to 330 lb**, with six roof rail mounts (three per side).

PERFORMANCE-GRADE BRAKING SYSTEM

Utilizing **high-performance Brembo[®] brakes**, Ram ProMaster employs a robust **four-channel antilock brake system (ABS)** that features independent control and monitoring of each wheel. Our advanced version of the Electronic Stability Control (ESC)⁴ system (standard on all models) integrates ABS with a variety of full-function All-Speed Traction Control technologies. ESC⁴ helps maintain control under common adverse conditions—like wet, icy or snow-covered roads, and during tight turns and evasive maneuvers. Our ESC⁴ system is comprehensive, with a Brake-Lock Differential, Brake Assist, Hill Start Assist, Engine Drag Control, Trailer Sway Control⁴ and Electronic Roll Mitigation.



CARGO TIE-DOWNS

Cargo Van models feature up to ten in-floor D-rings to help secure interior cargo, with up to 17 total side and floor tie-downs available.

A RESILIENT FRAME SUPPORTS BIG CARGO AND BIG UPFITS

A solid backbone is a designed-in advantage to the body-frame integral (unibody) engineering utilized here. The chassis for each Ram ProMaster model is **mass-optimized and tuned for ideal performance.** It incorporates a strong, integrated frame structure with strategically boxed frame components and multiple crossrails and longitudinal rails—all crucially welded together.

BUILT-IN LADDER-FRAME INTEGRITY

Depending on wheelbase length, we use up to **eight structural crossmembers**, giving Ram ProMaster the ladder-frame integrity that ensures proper stiffness and long-term durability.

RESPONSIVE RACK AND PINION STEERING

Our hydraulic-assist system uses a **premium steering gear**, engineered and tuned to meet long-term service. Curb-to-curb turning—even on longer wheelbase models—is impressive. The telescoping steering column is standard.

EFFICIENCY IN DESIGN

One elegant solution in three parts. The modular three-piece rear and front ends allow higher positions for the oversized headlamps and taillamps—a design that **significantly helps reduce both time and expenses** for service or needed repairs.



A FRONT END THAT ADDRESSES SAFETY AND SECURITY

Front crumple zones are engineered to absorb energy. Our goal is to create a vehicle **applauded for its Safety and Security features.** Ram ProMaster models were subjected to some of the most extensive crash and safety testing in the history of the company.

FRONT AND REAR: THE RIGHT SUSPENSION SYSTEMS

In front, a **MacPherson strut front suspension** utilizes large, 62-mm twin-tube shock absorbers for solid support of cargo. This system is enhanced with GVW-tuned cast-iron control arms, which offer remarkable durability and superb ride, handling and road manners, even under heavy loads. The front-wheel-drive engineering lets us employ a category-unique beam axle/leaf spring configuration in the rear that's lighter, simpler and just as robust as those on rear-wheel-drive vehicles.

SMART ARCHITECTURE

It's more than outstanding aerodynamics. The exterior design subtly hides conveniences you'll use day-in and year-out. The modular front fascia on all models incorporates handy footholds that simplify access to the engine compartment; cleaning a windshield or changing a wiper blade is a breeze. It's one more example of how this smart commercial design makes life—and work—easier.





EVEN THE INTERIOR GETS THE JOB DONE.

SPACIOUS, SECURE AND WORKER-FRIENDLY. EVERY OFFICE SHOULD HAVE SUCH APPOINTMENTS. From the expansive solar-glass windshield to the pallet-friendly rear doors, this is an interior designed around the driver and passengers. High-positioned seats (with available two-passenger bench seat, swivel seats and driver suspension seat) offer outstanding outward visibility, with soft-touch materials for armrest surfaces. Instrumentation is hand- and eye-friendly, with a standard telescoping steering column and easy-to-access controls. Abundant storage includes oversized door pockets, triple cup holders below the center stack, glove boxes with upper instrument panel storage, and an available overhead shelf system—which is so strong, the 2.5-liter area can hold 44 lb of materials. Given all the standard features backed with a long list of options, this is an office you can live with.

Properly secure all cargo.



COMFORTABLY CONNECTED. AND ALWAYS IN CONTROL.

WE KNOW. YOUR MOST VALUABLE CARGO goes beyond building materials, equipment or power tools. That's why we designed this cabin to be comprehensive, convenient and operator- and passenger-friendly. Built to meet the tough demands of the commercial sector, Ram ProMaster® takes its ergonomics and creature comforts seriously. The expansive windshield features solar-filter glass. Seats are high-positioned for superb outward visibility and driving comfort. Instrumentation is crisp and readable, with easy-to-access controls augmented with a vibrant LED-illuminated cluster with Driver Information Display.

Storage is abundant, with multiple compartments in each door, huge in-door pockets, triple center-

stack cup holders, an upper instrument panel bin, an available oversized lockable glove box...and much more. You need your space. It's right here.

Electronics are what you need for business and pleasure. Standard on all models: Uconnect® 3 with 5-inch touchscreen display features AM/FM audio system, a 2.5-amp fast-charging USB port, 12-volt power outlet and steering wheel-mounted controls. Also available are auxiliary switches to accommodate upfits and ancillary electronics. Telematics culminate in one of the best systems in the market: the multifaceted Uconnect delivers key information and access to entertainment features, further separating the 2018 Ram ProMaster portfolio from the pack.

OUR SMARTEST CALL WAS TO STUDY THE SMARTPHONE. Today's smartphones go far beyond merely making phone calls. Our colleagues at Uconnect applied the same concept to the radio. The standard **Uconnect 3 with 5-inch display** does its job with outstanding fidelity with readily accessed information through Bluetooth® technology and the 5-inch color touchscreen. At the top, the **Uconnect 3 NAV with 5-inch display** brings full-color clarity with exacting web-based, GPS Navigation to work. Available SiriusXM® Satellite Radio⁵ includes a one-year trial subscription. Staying in touch is imperative. Welcome to the integrated world of Uconnect—telematics at their best.

SEATING CONFIGURATIONS



BUCKET SEATS

Standard tubular-structured four-way bucket seats feature spring suspension and woven cloth. Available: six-way adjustable seats in cloth or vinyl with manual lumbar support and heated seat surfaces.

DRIVER'S SUSPENSION BUCKET SEAT

The available premium driver's suspension seat adds a pneumatic suspension and a weight/size-conformity adjustment knob.



THREE-OCCUPANT SEATING

Here, the single driver's bucket seat is joined by an integrated two-person bench seat; in-cab capability is also enhanced: the middle seatback insert folds down to become a convenient writing surface.



SWIVEL SEATING

Need to access the rear compartment with ease? Available swivel bucket seats in long-wearing cloth are the answer, with 180° inboard swivel range, 35° outboard swivel, 58° recliner and a continuous height adjuster.

Uconnect®

SiriusXM⁵
SATELLITE RADIO



UCONNECT® 3 with 5-INCH DISPLAY

- ▶ AM/FM stereo
- ▶ MP3 capability with auxiliary input
- ▶ Integrated Voice Command⁶
- ▶ Steering wheel-mounted audio controls
- ▶ Five-inch color touchscreen
- ▶ Four-speaker sound system



UCONNECT 3 NAV with 5-INCH DISPLAY

- ▶ All features of the Uconnect 3 system
- ▶ GPS Navigation
- ▶ Points-of-Interest accessibility
- ▶ Turn-by-turn Navigation

YOUR CUSTOM UPFIT IS LESS THAN A FEW BLOCKS AWAY.



Rear Window Guards, Cargo Shelving Kits and Rear Step



FORGET THE AFTERMARKET HASSLES. GET AN UPFIT RIGHT FROM THE SOURCE.

THE MOPAR® CUSTOM SHOP. For the ideal upfit that meets every specification you need, partner up with the right people. In this case, it's the very team that designed your Ram ProMaster®

Working with this team to facilitate your custom upfit makes the process faster, easier and more efficient than ever. The Mopar Custom Shop—located in the same neighborhood as the ProMaster manufacturing plant—is a one-stop shop with multiple solutions for your ProMaster upfit. Utilizing accessories and features designed for your vehicle, the Mopar Custom Shop ensures made-to-order customization and delivers a ready-to-work vehicle. It's just plain smart. For more info, see your Ram ProMaster dealer or visit MOPAR.COM



Locking Gas Cap



Mopar® Front and Rear Assist Handles



Roadside Safety Kit,
DOT-Compliant

LED Cargo-Area Lights



Fog Lights*



Hitch Receiver,[†] Molded Flat Splash Guards and Cargo-Area Floor Covering

Side Window Air Deflectors



*Check state and local regulations on installation and use. [†]Check User Guide for hitch type, load capacity and heavy-duty equipment required. Do not exceed rated tow capacity of the vehicle as equipped. Trailer may require items not supplied by Mopar.

RAM PROMASTER® BUYER'S GUIDE

	Van	Chassis Cab	Cutaway
CPO5 PACKAGE	2TA	2TA	2TA
ENGINE / TRANSMISSION			
3.6L PENTASTAR® V6 WITH VARIABLE VALVE TIMING (VVT) / 6-SPEED AUTOMATIC TRANSMISSION (standard on all models)	21A	21A	21A
MECHANICAL FEATURES			
ADDITIONAL KEY FOBS – Two	0	0	0
ALTERNATOR – 180-amp	•		
– 220-amp	0	•	•
AUXILIARY FUEL TAP	•	•	•
BATTERY – 800-amp, maintenance-free	•	•	•
– Auxiliary Power Connector	•	•	•
BULB OUT – Detection Defeat for LED		0	0
CRUISE CONTROL	0	0	0
ELECTRONIC STABILITY CONTROL (ESC) [†]	•	•	•
ELECTRONIC VEHICLE TRACKING SYSTEM (by Mopar®)	0	0	0
ENGINE BLOCK HEATER	0	0	0
FUEL TANK – 24-gallon	•	•	•
FULL-SIZE SPARE TIRE	•	•	•
POWER STEERING	•	•	•
SPEED LIMITER – Dealer-activated, 60-mph, 65-mph, 70-mph and 77-mph	•	•	•
SUSPENSION – Heavy-duty rear stabilizer bar (3500 models only)	P	•	•
– Light-duty (118-inch WB 1500 models only)	•		
– Medium-duty (136-inch WB 1500 models only)	•		
– Heavy-duty (2500/3500 models only)	•		
– Premium heavy-duty (3500 models only)	0	•	•
TEMPORARY SPARE TIRE MOUNT		0	0
EXTERIOR FEATURES			
CAB BACK WALL – With window		•	
CHROME GRILLE (included with Premium Appearance Group)	P	P	P
DAYTIME RUNNING LAMPS	0	0	0
DOORS, REAR – 260-degree-opening with no glass	•		
– Rear – 260-degree-opening with fixed glass	0		
DOORS, SIDE – Left-side with fixed window and grate (not available on 118-inch WB)	0		
– Left-side with no glass (not available on 118-inch WB)	0		
– Right-side with fixed window and grate	0		
– Right-side with no glass	•		
EXTENDED WIRING – Taillamp		•	•
FRONT FOG LAMPS (included with Premium Appearance Group)	P	P	P
FRONT LICENSE PLATE BRACKET	0	0	0
HALOGEN HEADLAMPS	•	•	•
MIRRORS – Wide exterior 96-inch (includes power heated mirrors on Cargo Vans)	P	•	•
– Manual-adjustable/manual-folding	•	•	•
– Power-adjustable/power-folding, heated	0		
– Wide power heated exterior 96-inch	0	0	0
ROOF CLEARANCE LAMPS – Delete front clearance lamps		0	0
– Front	•	•	•
– Rear	•		
SPLASH GUARDS – Set (by Mopar)	0		

• = Standard 0 = Optional P = Available within Package

RAM PROMASTER® BUYER'S GUIDE (CONTINUED)

	Van	Chassis Cab	Curaway
	2TA	2TA	2TA
CPOS PACKAGE			
EXTERIOR FEATURES (CONTINUED)			
STEP – Rear bumper extension (not available with Trailer Tow Group; check with dealer for availability; by Mopar®)	0		
– Sliding door step, left side (by Mopar; late availability)	0		
– Sliding door step, right side (by Mopar; late availability)	0		
WHEELS – 16-inch aluminum	0	0	0
– 16-inch Silver painted steel with center cap	•	•	•
– 16-inch Silver painted steel with full wheel cover	0	0	0
– Delete center cap	0	0	0
WINDOW DEFROSTER – Rear (requires rear doors with glass on Cargo Vans)	0		
INTERIOR FEATURES			
12-VOLT AUXILIARY POWER OUTLET – Front	•	•	•
– Rear	0		
AIR CONDITIONING – Delete air conditioning; heater only	0	0	0
– Manually controlled, with heat	•	•	•
– Rear Heater Air Conditioning Prep Package (not available with air conditioning delete)	0	0	0
ASSIST HANDLE – Rear doors (by Mopar)	0		
AUXILIARY UPFITTER SWITCHES – Two	0	0	0
CARGO-AREA LIGHTING – Incandescent	•		
– LED (by Mopar)	0		
CARGO COMPARTMENT FLOOR MAT (by Mopar)	0		
CARGO PARTITION – None	•		
– With sliding window	0		
– Without window	0		
CARGO TIE-DOWNS – Floor	•		
– Side-wall	•		
FRONT WALK-THRU MAT – Carpet (not available with passenger double seat; by Mopar)	0		
– Slush (not available with passenger double seat; by Mopar)	0		
HIGH HEADLINER (not available on Standard Roof models; restrictions apply; by Mopar)	0		
INSTRUMENT PANEL WITH BRIGHT BEZELS	0	0	0
LOCKING GLOVE BOX (included with Interior Convenience Group)	P	P	P
POWER DOOR LOCKS – Speed-sensitive	•	•	•
REAR DOOR STORAGE NET (included with Interior Convenience Group)	P		
SEATING SURFACES – Cloth	•	•	•
– Vinyl (not available with swivel seats)	0	0	0
SEATS – 4-way manually adjustable driver- and front-passenger bucket	•	•	•
– Driver's 6-way adjustable with lumbar adjuster (not available with driver's suspension seat or passenger swivel seat)	0	0	0
– Driver/passenger 6-way adjustable with lumbar adjuster (not available with passenger double seat, driver swivel seat or driver's suspension seat)	0	0	0
– Driver's suspension (not available with driver's swivel seat, heated driver seat or 6-way adjustable seat)	0	0	0
– Driver's swivel (requires cloth seating surfaces; not available with passenger double seat, cargo partition or heated seat)	0	0	0
– Heated driver (requires 6-way adjustable driver's seat)	0	0	0
– Heated passenger (requires 6-way adjustable driver/passenger seats)	0	0	0
– Passenger double	0	0	
– Passenger-seat delete	0	0	0
– Passenger swivel (requires cloth seating surfaces and driver swivel seat; not available with cargo partition or heated seat)	0	0	0
SHELF ABOVE ROOF TRIM (included with Interior Convenience Group)	P	P	P
SPRAY-ON FLOOR LINER (by Mopar)	0		

• = Standard 0 = Optional P = Available within Package

RAM PROMASTER® BUYER'S GUIDE (CONTINUED)

	Van	Chassis Cab	Cutaway
	2TA	2TA	2TA
CPOS PACKAGE			
INTERIOR FEATURES (CONTINUED)			
STEERING COLUMN – Telescoping	•	•	•
STEERING WHEEL – Leather-wrapped	0	0	0
TIRE PRESSURE MONITORING LIGHT	•	•	•
UPFIT INTERFACE CONNECTORS (included with Rear-Speaker Wiring Prep)	•	•	•
WALL PANELS – Upper-side (includes lower-side)	0		
– Lower-side	0		
WINDOWS – Power with one-touch down feature	•	•	•
– Window guards, rear (not available on 118-, 136-inch Standard Roof Cargo Vans)	0		
WINDSHIELD DOCUMENT HOLDER (included with Interior Convenience Group)	P	P	P
WOOD FLOOR – Rear	0		
MULTIMEDIA			
MOPAR® WEB WIFI HOTSPOT ⁷	0	0	0
REAR-SPEAKER WIRING PREP (includes upfit interface connectors)	•	•	•
SIRIUSXM® SATELLITE RADIO ⁵	0	0	0
UCONNECT® 3 WITH 5-INCH DISPLAY (includes Media Hub with USB and auxiliary inputs and steering wheel-mounted audio controls)	•	•	•
UCONNECT 3 NAV WITH 5-INCH DISPLAY (includes Navigation)	0	0	0
SAFETY AND SECURITY			
AIR BAGS ⁸ – Advanced driver and front-passenger	•	•	•
– Supplemental front-seat side	•	•	•
– Supplemental side-curtain front	•	•	•
DOT-COMPLIANT ROADSIDE SAFETY KIT	0	0	0
PARKSENSE® REAR PARK ASSIST ³	0		
PARKVIEW® REAR BACK-UP CAMERA ³	•		
REAR BACK-UP CAMERA ³ KIT		•	•
REMOTE KEYLESS ENTRY	•	•	•
REMOTE START (by Mopar)	0	0	0
SECURITY ALARM	0	0	0
PACKAGES			
INTERIOR CARGO SHELF PACKAGE (requires Cargo Partition or Cargo Partition with sliding window; by Mopar)	0		
INTERIOR CONVENIENCE GROUP – Includes locking glove box, shelf above roof trim, underseat storage tray, rear door storage net (Cargo Van only) and windshield document holder	0	0	0
PREMIUM APPEARANCE GROUP – Includes chrome grille and fog lamps	0	0	0
TRAILER TOW GROUP – Includes Class IV hitch receiver with 4- and 7-pin wiring harness (by Mopar)	0		

• = Standard 0 = Optional P = Available within Package

WHEELS



16-inch Painted Steel Wheel with Center Cap
(standard)



16-inch Wheel Cover
(available)



16-inch Aluminum Wheel
(available)

EXTERIOR COLORS



Bright White



Sandstone Pearl



Broom Yellow



Flame Red



Deep Cherry Red Crystal Pearl



True Blue Pearl



Granite Crystal Metallic



Bright Silver Metallic



Black

INTERIOR FABRICS

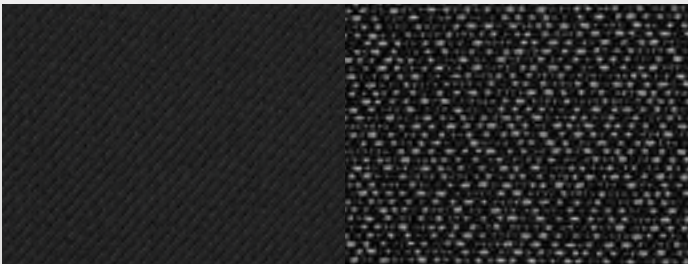

Black Cloth
(standard)

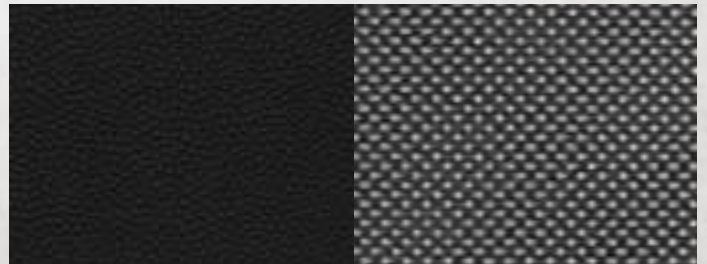

Black Vinyl
(available)



RAM PROMASTER® LINEUP. From left to right: ProMaster 3500 Cargo Van with High Roof; ProMaster 3500 Cutaway with aftermarket Utility Box Upfit; ProMaster 3500 Chassis Cab with aftermarket Cube Box Upfit; ProMaster 1500 Cargo Van with Standard Roof.



A STAR: 3.6L PENTASTAR® V6

A STELLAR PERFORMER IN THE RAM COMMERCIAL ARSENAL. It's got it all: impressive takeoff and acceleration. Fuel-sipping performance. An enviable resumé of multiple awards. Up to 10,000-mile oil change intervals. Long-proven in the commercial sector, the 3.6L Pentastar V6 features advanced multiport fuel injection, electronic throttle control, available integrated cruise control—and **best-in-class¹ standard V6 horsepower.** Add the available Trailer Tow Group, and tow up to 5,100 lb when properly equipped.

280 HORSEPOWER 260 LB-FT OF TORQUE

5 YR / 60,000 MI²
POWERTRAIN LIMITED WARRANTY

3.6L PENTASTAR® V6

HORSEPOWER	280 hp @ 6,400 rpm
TORQUE	260 lb-ft @ 4,175 rpm
CONFIGURATION	60-degree V6
DISPLACEMENT	220 cu in / 3604 cc
BORE x STROKE	3.78 x 3.27 in / 96.0 x 83.0 mm
BLOCK MATERIAL	Aluminum
CYLINDER HEAD MATERIAL	Aluminum alloy
AIR INDUCTION	Naturally aspirated
VALVE TRAIN	Chain-drive DOHC, 24-valve
FUEL DELIVERY	Sequential, multiport injection
RECOMMENDED FUEL	Unleaded regular (87 octane)
COMPRESSION RATIO	10.2:1
ALTERNATOR	180-amp (220-amp available)
OIL CAPACITY	6.0 qt
MAXIMUM RECOMMENDED OIL CHANGE INTERVAL	10,000 mi

RAM PROMASTER® CARGO VAN – SPECIFICATIONS



CAPABILITY

	CARGO VAN						
	1500		2500		3500		
	118" WB	136" WB		136" WB	159" WB	159" WB	159" WB, EXTENDED
	STANDARD ROOF	STANDARD ROOF	HIGH ROOF	HIGH ROOF		HIGH ROOF	
GVWR (lb)	8,550	8,550	8,550	8,900	8,900	9,350	9,350
GCWR (lb)	11,500	11,500	11,500	11,500	11,500	11,500	11,500
BASE CURB WEIGHT (lb)	4,551	4,650	4,776	4,756	4,883	4,912	5,009
MAXIMUM PAYLOAD* (lb)	4,000	3,900	3,770	4,140	4,020	4,440	4,340
FRONT GAWR (lb)	4,629	4,629	4,629	4,629	4,629	4,629	4,629
REAR GAWR (lb)	5,004	5,291	5,291	5,291	5,291	5,291	5,291
CURB-TO-CURB TURNING (ft)	36.3	40.7	40.7	40.7	46.8	46.8	46.8
MAXIMUM TOWING† (lb) SAE J2807 Compliant	5,100	5,100	5,100	5,100	5,100	5,100	5,100

DIMENSIONS

BODY HEIGHT (in)	88.7	88.7	99.4	99.4	99.4	99.4	99.4
OVERALL BODY LENGTH (in)	195.4	213.1	213.1	213.1	236.1	236.1	250.5
VEHICLE WIDTH WITHOUT MIRRORS (in)	80.7	80.7	80.7	80.7	80.7	80.7	80.7
VEHICLE WIDTH WITH MIRRORS EXTENDED (in)	105.9	105.9	105.9	105.9	105.9	105.9	105.9
CARGO BODY OVERALL LENGTH (in)	105.1	122.8	122.8	122.8	145.9	145.9	160.2
SIDE DOOR OPENING WIDTH (in)	42.3	49.2	49.2	49.2	49.2	49.2	49.2
SIDE DOOR OPENING HEIGHT (in)	58.5	58.5	69.0	69.0	69.0	69.0	69.0
REAR DOORS OPENING WIDTH (in)	61.5	61.5	61.5	61.5	61.5	61.5	61.5
REAR DOORS OPENING HEIGHT (in)	59.8	59.8	70.5	70.5	70.5	70.5	70.5
MAXIMUM CARGO VOLUME (cu ft)	259.2	303.7	352.9	352.9	420.2	420.2	462.8

*Max payload based on body model, GVWR class. When properly equipped. †When properly equipped.

RAM PROMASTER® CHASSIS CAB AND CUTAWAY – SPECIFICATIONS

CAPABILITY

	CHASSIS CAB			CUTAWAY		
	3500			3500		
	136" WB	159" WB	159" WB, EXTENDED	136" WB	159" WB	159" WB, EXTENDED
	81.1" CA	104.1" CA	104.1" CA	81.1" CA	104.1" CA	104.1" CA
GVWR (lb)	9,350	9,350	9,350	9,350	9,350	9,350
GCWR (lb)	11,500	11,500	11,500	11,500	11,500	11,500
BASE CURB WEIGHT (lb)	4,175	4,214	4,243	4,114	4,145	4,194
MAXIMUM PAYLOAD* (lb)	5,180	5,140	5,110	5,240	5,210	5,160
FRONT GAWR (lb)	4,629	4,629	4,629	4,629	4,629	4,629
REAR GAWR (lb)	5,291	5,291	5,291	5,291	5,291	5,291
CURB-TO-CURB TURNING (ft)	40.7	46.8	46.8	40.7	46.8	46.8
MAXIMUM TOWING† (lb)	5,100	5,100	5,100	5,100	5,100	5,100

DIMENSIONS

BODY HEIGHT (in)	84.8	84.8	84.8	84.8	84.8	84.8
OVERALL BODY LENGTH (in)	207.0	230.0	244.4	207.0	230.0	244.4
VEHICLE WIDTH WITHOUT MIRRORS (in)	80.7	80.7	80.7	80.7	80.7	80.7
VEHICLE WIDTH WITH MIRRORS EXTENDED (in)	105.9	105.9	105.9	105.9	105.9	105.9
CAB TO REAR AXLE‡ (in)	81.1	104.1	104.1	81.1	104.1	104.1
OVERHANG REAR AXLE TO END OF FRAME** (in)	33.9	33.9	48.2	33.9	33.9	48.2

*Max payload based on body model, GVWR class. When properly equipped. †When properly equipped. ‡Measured from center cab back to center of rear axle.
 **Measured from center of axle to rear frame. Specifications subject to change. See your dealer for the most up-to-date information. WB = wheelbase. CA = cab-to-axle.



RAM PROMASTER® - CONFIGURATIONS

1500

2500

3500

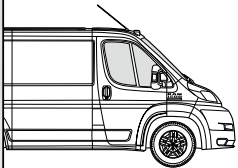

CARGO VAN
STANDARD ROOF

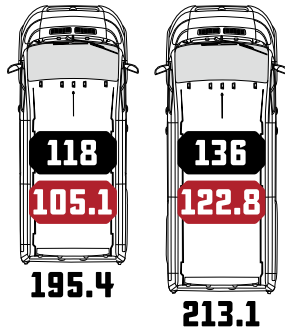

- 000** WHEELBASE LENGTH IN INCHES
- EXT** BODY/CHASSIS EXTENDED 14 INCHES
- 000** LOAD FLOOR LENGTH IN INCHES
- 000** CAB-TO-AXLE LENGTH IN INCHES
- 000** OVERALL BODY LENGTH IN INCHES

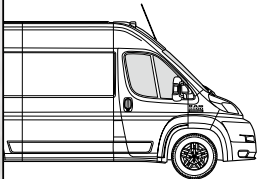

CARGO VAN
AVAILABLE HIGH ROOF

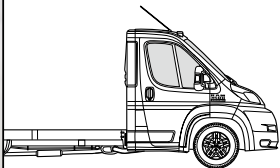
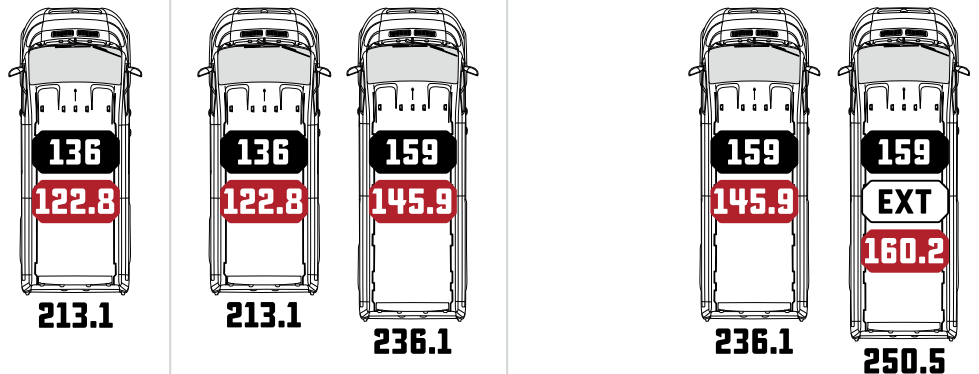

**CHASSIS CAB/
CUTAWAY**
STANDARD ROOF ONLY

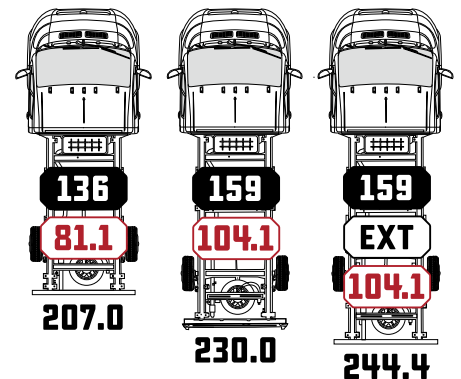

BUSINESS LINK

The fast lane for small business.

THE DEALER NETWORK FOR YOUR BUSINESS.

Your **BusinessLink** dealer is committed to providing you, the small business owner, with the vehicle support you need for your business, from servicing all makes and models of your existing vehicles to selling you the right vehicles needed to perform the work that you do. Your **BusinessLink** dealer provides priority service because we know downtime is costing you money. Your **BusinessLink** dealer has sales

professionals trained to properly "job-rate" the right vehicle for your work application along with providing commercial finance options. New vehicle sales to qualified small business owners also receive a free alternate transportation contract, in the event your vehicle is in for service.

Membership in the **BusinessLink** program is free. Membership helps us to identify you as a small business owner so we can provide you with both the service you deserve and update you with offers that can help reduce the cost of doing business. Ask your **BusinessLink** dealer to register today.

BusinessLink has you covered.

- ▶ Full Range of FCA Commercial Vehicles
- ▶ Free Membership
- ▶ Priority Service
- ▶ Extended Service Hours
- ▶ Dedicated Staff of Commercial Vehicle Experts
- ▶ Free Alternate Transportation
- ▶ Generous Incentives
- ▶ Expertise in Commercial Financing Options
- ▶ 24/7 Towing Service Available

For more information, log on to FCAUSFLEET.COM or call us toll-free at 877-2THELINK (877-284-3546).

ON THE JOB

INCENTIVES FOR SMALL BUSINESSES.

Running a business presents plenty of challenges. Like cutting costs, not corners. Like saving time and money and eliminating hassles. The **ON THE JOB**[®] commercial incentive program provides assistance in customizing and servicing your business vehicles.

ON THE JOB[®] allowances make your business more profitable!

- ▶ **NO-EXTRA-CHARGE** 2-Year Gas/4-Year Diesel Lube-Oil-Filter Allowance
- ▶ **UP TO \$1,000** Commercial Graphics Program Allowances
- ▶ **UP TO \$1,000** Commercial Equipment/Upfit Allowances
- ▶ **\$300 - \$1,000** Allowance on Select Mopar[®] Service Contracts

See your dealer for specific program rules and details, log on to FCAUSFLEET.COM or call us toll-free at 877-ONTHEJOB (877-668-4356).

A commercial line of credit from Chrysler Capital is ideal for qualified business customers looking for a flexible, easy way to manage growing vehicle needs. Chrysler Capital streamlines the process—and, with prequalification, you're ready to buy a vehicle when you need it. Ask your **BusinessLink** dealer for details.

CHRYSLER CAPITAL

RAM OUTFITTER

RAMTRUCKS.COM/OUTFITTER



1 Based on latest available competitive information. Class is based on Large Commercial Van segment (Class 2). 2 Transferable. See your dealer for complete details and a copy of the 5-Year/60,000-Mile Gas Powertrain Limited Warranty. 3 Always look before proceeding, electronic drive aid is not a substitute for conscientious driving; always be aware of your surroundings. 4 No system, no matter how sophisticated, can repeal the laws of physics or overcome careless driving actions. Performance is limited by available traction, which snow, ice and other conditions can affect. When the ESC warning lamp flashes, the driver needs to use less throttle and adapt speed and driving behavior to prevailing road conditions. Always drive carefully, consistent with conditions. Always wear your seat belt. 5 SiriusXM audio and data services each require a subscription sold separately or as a package by Sirius XM Radio Inc. Your SiriusXM service will automatically stop at the end of your trial unless you decide to subscribe. **If you decide to continue service after your trial, the subscription plan you choose will automatically renew thereafter and you will be charged according to your chosen payment method at then-current rates.** Fees and taxes apply. To cancel, you must call SiriusXM at 1-866-635-2349. See SiriusXM Customer Agreement for complete terms at www.siriusxm.com. All fees and programming subject to change. Not all vehicles or devices are capable of receiving all services offered by SiriusXM. Current information and features may not be available in all locations or on all receivers. 6 Requires a mobile phone equipped with the Bluetooth Hands-Free Profile. Visit UconnectPhone.com for system and device compatibility. 7 WiFi subscription required. This feature is not intended for use by the driver while the vehicle is in motion. Always drive carefully. 8 The Advanced Front Air Bags in this vehicle are certified to the new U.S. Federal regulations for Advanced Air Bags. Children 12 years old and younger should always ride buckled up in a rear seat. Infants in rear-facing child restraints should never ride in the front seat of a vehicle with a passenger front air bag. All occupants should always wear their lap and shoulder belts properly. 9 ON THE JOB is a retail incentive program; see your dealer for official rules. Inquire about eligibility by calling 877-ONTHEJOB or by logging on to fcausfleet.com. The purchaser or lessee must be a qualified commercial customer for more than 30 days prior to the date of the vehicle purchase. An official ON THE JOB Customer Acknowledgment Form must be signed by the customer (provided by the dealer).

©2017 FCA US LLC. All Rights Reserved. Ram, Mopar, Ram ProMaster, the Ram's Head logo, the BusinessLink design, ParkSense, ParkView, Pentastar and Uconnect are registered trademarks, and the On The Job design is a trademark of FCA US LLC. Chrysler Capital is a registered trademark of FCA US LLC and licensed to Santander Consumer USA Inc.

Sortimo is a registered trademark of Sortimo International GmbH. Knapheide is a registered trademark of Knapheide Manufacturing Company. Bosch is a registered trademark of Robert Bosch GmbH. Brembo is a registered trademark of Brembo S.p.A. DensGlass[®], the color GOLD and the Georgia-Pacific logo are trademarks owned by or licensed to Georgia-Pacific Gypsum LLC. Facebook and logo are registered trademarks of Facebook, Inc. The Twitter logo is a service mark of Twitter, Inc. The YouTube logo is a registered trademark of Google Inc. Instagram and logo are registered trademarks of Instagram, Inc. Bluetooth is a registered trademark of Bluetooth SIG, Inc. Sirius XM Connected Vehicles Services Inc. Sirius, XM, SiriusXM and all related marks and logos are trademarks of Sirius XM Radio Inc. Grizzly is a trademark of Grizzly Coolers LLC.

About this catalog: since the time of printing, some of the information you'll find in this catalog may have been updated. Ask your dealer for details. Some of the equipment shown or described throughout this catalog may be available at extra cost. Specifications, descriptions, illustrative materials and all competitive comparisons contained herein are as accurate as known at the time this publication was approved for printing. FCA US LLC reserves the right to discontinue models at any time or change specifications without notice or without incurring obligation. Options may be required in combination with other options. For the price of the model with the equipment you desire, or verification of specifications contained here, see your Ram dealer.



Join our community on Facebook, submit your photos on Instagram, follow us on Twitter and check us out on YouTube.



RAM ZONE

Join fellow Ram enthusiasts and tell your story by posting comments, participating in discussions and sharing your photos and videos.

Ram is a registered trademark of FCA US LLC.



65.4-INCH
CARGO AREA HEIGHT¹
Standard
Cargo Van

75.6-INCH
MAXIMUM
CARGO WIDTH¹



55.8-INCH
CARGO WIDTH
between wheel wells¹



3.6L
PENTASTAR[®] V6
280 HP with 260 LB-FT of torque
Standard V6 horsepower¹

21-INCH
LOAD FLOOR HEIGHT¹
Cargo Van



36.3-FT
TURNING DIAMETER¹
When properly equipped

**FRONT-WHEEL-DRIVE
SYSTEM¹**
Excels in adverse weather
conditions



**ELECTRONIC
STABILITY CONTROL¹**
Standard

UCONNECT[®] 3
WITH **5-INCH**
TOUCHSCREEN DISPLAY
Standard



**GAS ENGINE OIL
CHANGE INTERVALS**
up to **10,000 MILES**
3.6L Pentastar V6

**5-YEAR/
60,000-MILE²**
POWERTRAIN
LIMITED WARRANTY



RAM
COMMERCIAL

RAMTRUCKS.COM/PROMASTER