



Q5

Audi Q5 | Q5 hybrid

Audi
Truth in Engineering



Material proof that the world revolves around you.

Who says you can't always be the center of attention? When you're sitting behind the wheel of the redesigned 2013 Audi Q5, that is at least a distinct possibility. For those fortunate enough to experience this level of personal attentiveness, the Q5 becomes far more than your biggest fan. Just think of its unmistakable profile. Its sporty yet sophisticated style. The fuel-saving potential of the new Q5 hybrid model.^{1,2} Or how its interior offers a progressive and luxurious escape from the outside world. And then imagine all the possibilities that the available advanced technologies on board can make real, from helping you find a new restaurant using the power of Google™ Local Search to providing almost limitless entertainment courtesy of SiriusXM Satellite Radio, to dialing in your personal comfort. Because, in the Q5, your every need is given its time in the limelight.

.01 - Design Line

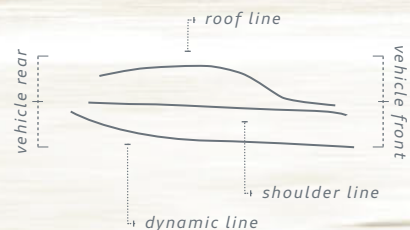

Notice how the Dynamic line of the Q5 creates a dramatic lighting effect while also bringing the vehicle closer to the road. Its Roof line creates a sporty, coupe-like silhouette, providing just the right amount of visual muscle.

-- fig. 01

1 The Q5 hybrid is available in the U.S. in limited quantities and only at participating Audi dealers. 2 24 city/30 highway mpg (2013 Q5 hybrid, with eight-speed Tiptronic® transmission). EPA estimates. Your mileage will vary.



2013 Audi Q5 2.0T Premium shown in Ice Silver metallic.



2013 Audi Q5 2.0T Premium plus shown in Ice Silver metallic with optional 19" 5-double-spoke design wheels.

Never shy away from a close-up.

Anyone can make a big entrance. Making it memorable is what really sets you apart. Take a walk around your Audi Q5 and you'll quickly realize why this isn't a vehicle anyone will easily forget. Its striking wheels are highlighted by the elegant arc of the fenders, while the gracefully sloping roofline, accentuated by aluminum roof rails, evokes a coupe-like presence. From the front, the Audi Singleframe® grille takes center stage with an assertive, unmistakably Audi look, while available brilliant xenon plus headlights and signature LED daytime running light technology let everyone know this is not your typical SUV.



~ fig. 02

.02 - LED Daytime Running Light Technology

Stylish and iconic, available LED daytime running lights help enhance the unmistakable look and design of the Audi Q5 as well as its visibility to other drivers, especially during the dawn and dusk hours.

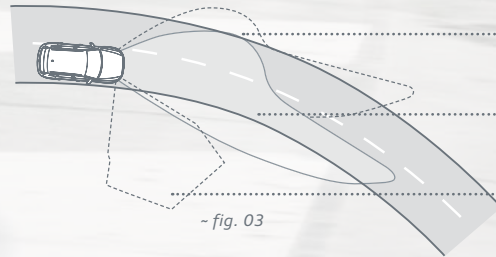

~ fig. 03

.03 - Audi Adaptive Xenon Plus Headlights

When driving straight, the headlights disperse light over a wide area while also casting light farther down the road on the passenger's side to help provide better long-range visibility.

Swiveling up to 15 degrees, the available Audi adaptive xenon plus headlights direct light based on steering wheel input so that you can easily track the road ahead.

Activated when you use the turn signal, the cornering light illuminates the area to which you intend to go, giving you a well-lit path even before you initiate the turn.



There's a reason we think losing weight is the smart move.

Considering the racing DNA in every Audi, it should come as no surprise that we went to great lengths to reduce weight when designing the Audi Q5. But there is an even greater benefit to a reduction in weight beyond just improved handling. By using aluminum in such components as the hood, tailgate, wheels and suspension, we shed a significant amount of unwanted weight, helping to diminish the load on the engine and increase overall drivability.

.04 - *Weight-saving Aluminum*

Using aluminum helps reduce weight while still making for a structurally sound vehicle. And in no place is this more evident than in the all-aluminum tailgate. It weighs markedly less than a typical steel tailgate, due to its lightweight aluminum structure and clam-shell design, and helps provide exceptional structural integrity.

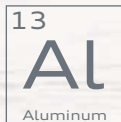

.05 - *19" Alloy Wheels*

Adding to the already striking exterior presence are available 19" alloy wheels designed to show off the powerful stance of the Q5.



In here, it's all about you.

Striking a perfect balance between luxury and style is no easy task, but the Audi Q5 seems to do it with relative ease. The interior layout is driver-oriented, with every control, gauge and switch-gear placed with convenience in mind. Look around and you'll also notice the high-quality materials and fine craftsmanship that envelop every square inch. From the standard Dark Brown Walnut Wood inlays to the carefully stitched leather seating surfaces, to the available three-spoke steering wheel, it all comes together to create an interior that exudes character. And when it comes time to find your favorite song or next destination, count on the available Audi MMI® Navigation plus to put it all right at your fingertips.¹



06 - Wood Inlays

Speaking to the detail and craftsmanship of the Q5 are premium genuine wood inlays. They are selected, crafted and matched to the color of the dashboard and leather seating surfaces to compensate for variations in texture and reflectivity.

1 See Infotainment/Technology section of the Featured Content page for important information regarding the Audi MMI® Navigation plus system.

Affording options even when you think you're out of them.

Think of it this way—you may never run out of ways to enjoy your Audi Q5. Available twelve-way, power-adjustable front seats give you almost unlimited options when it comes to personal comfort, while sliding and reclining rear seats make sure your passengers are included in this luxurious experience. And just try to exhaust the possible configurations afforded by the 40/20/40 split folding rear seats. We'll go out on a limb and say you can't.



~ fig. 04

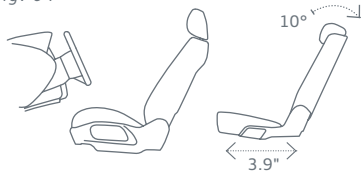

.07 - Adjustable Rear Seats

An adjustable rear bench enables the rear seats to recline 10°, move forward or back 3.9 inches and fold completely flat, allowing for flexible cargo configurations and additional rear leg room when needed.

.08 - Twelve-way Power Front Seats

Perfect comfort for both the driver and front passenger is just a touch of a button away with the available twelve-way power front seats.



fig. 05

2013 Audi Q5 3.0T Prestige shown in Titanium Gray leather with available Comfort and Driver Assist packages.



European model shown with optional equipment.



.09 - *Panoramic Sunroof*

The available two-panel panoramic sunroof offers both the front and rear passengers an unobstructed view overhead while flooding the cabin with natural light. And when you decide you need to say goodbye to the sun, a power sunshade is there to make it an easy task.

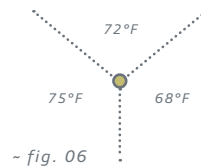

.10 - *Three-zone Automatic Climate Control*

With three distinct climate zones, the driver, front passenger and rear passengers can set their perfect level of heating or cooling with a simple twist of a dial on the center console.



There are times you know the world is yours.

For us, the perfect drive is when we feel a cool breeze as the sunlight fills the cabin. That's why, in the Audi Q5, we've imagined ways to create a unique, light-filled interior that warms while it calms. We've also developed systems that help deliver personalized comfort to the driver as well as to both the front and rear passengers. And when it comes time to pick up that new armoire, you'll rest easy knowing you have plenty of cargo space to work with.

- fig. 07

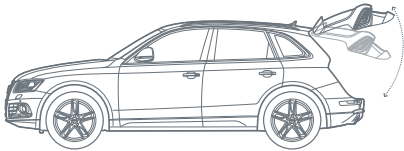

.11 - Power Tailgate

With a unique clamshell design that seamlessly integrates into the rear, the available power tailgate on the Q5 gives you programmable end points so you can adjust the opening to the height you choose—a big help in tight spaces.



quattro

Confidence-inspiring

Under ideal conditions, power is 40:60 rear-wheel-biased to help maximize acceleration and cornering, but the instant conditions become more challenging, the ratio is optimized for superior grip and control.

It's a bond between your car and the road.

It's true that while the Audi quattro® all-wheel drive may have been engineered to help drive through inclement weather and in low-traction situations, the real magic of this advanced system is how it performs in the dry. Power is distributed to all four wheels working in concert to help grip every corner while giving you the optimal amount of power delivery where and when it's needed. In other words, quattro® helps enhance performance by appropriately transferring power to the necessary wheels when accelerating and turning, so you have confidence-inspiring performance when the road isn't at its best. Inclement weather aside, the really gripping story about quattro® is how it performs overall, forging a sure bond between you, your Audi Q5 and the road.¹

¹ When driving during cold, rainy, snowy or icy weather conditions, ensure that your vehicle is equipped with appropriate all-season or winter-weather tires. Even with appropriate tires, you must always drive in a manner appropriate for the weather, visibility and road conditions.



Torque split

When accelerating out of a turn, up to 80% of the power is mechanically shifted to the rear wheels, where it's best allocated to propel the vehicle to your desired speed and onto the straightaway. Once traveling in a straight line again, the 40:60 power distribution that quattro® delivers to the front and rear wheels, respectively, gives you maximum torque to push onward.

Torque vectoring

It's a handling feature that seems to respond to your impulses before your steering input. An evolution of cross-axle lock, this system works within quattro® while utilizing ESC and ABS to help sense traction loss from the inside cornering tire.

.12 – *Electric Power Steering*

The electromechanical power steering combines precision and comfort with impressive energy-saving technology. It not only is an ideal complement to the available adaptive damping suspension, but also requires considerably less energy than a hydraulic system, due to its less complex design and significant reduction in weight. Removing the power steering pump helps reduce parasitic drag, resulting in enhanced performance.



2013 Audi Q5 3.0T Prestige shown in Ice Silver metallic with 20" 5-double-spoke off-road design wheels.

Express yourself out there.

With four different modes expressing your individual driving preferences, the exclusive Audi drive select system available in the Audi Q5 helps give you the ability to adjust the vehicle's steering, throttle response, suspension, and transmission shift characteristics. It helps you articulate how you want your Q5 to respond to the drive. The four modes of Audi drive select cover the full spectrum of driving and road conditions. So whether driving on a winding country road or a busy interstate, there is a mode that helps your vehicle respond the way you want it to. Since the roads you drive are not always optional, we think how you choose to drive them should be.

- *Comfort mode*

Perfect for less-than-perfect roads, this mode adds optimized settings for suspension and steering and a closer shift pattern to help provide a more relaxed drive.



Comfort

- *Dynamic mode*

More precise steering and suspension and a more responsive throttle give this setting an aggressive feel and focused performance.



Dynamic

- *Auto mode*

The best of both worlds, dialed to automatically adjust settings for a seamless combination of comfort and responsiveness based on your driving style and road conditions.



Auto

- *Individual mode*

Take the turn your way—this mode allows you to adjust the steering, suspension, throttle and transmission upshifts to your style.



Individual

suspension

engine

transmission

steering



It's as much about your pulse rate as our power.

If your Audi Q5 had a beating heart this would be it. Whether you choose the acclaimed 2.0 TFSI® engine that delivers impressive torque and punchy off-the-line acceleration while still returning excellent fuel economy or the supercharged 3.0 TFSI® engine that delivers the potent performance of a traditional V8 with the thirst of a V6, your pulse will surely race.^{1,2}

.13 - 3.0 TFSI® Supercharged V6

Audi TFSI adds forced induction to Audi FSI® technology whereby fuel is directly injected into the combustion chambers at precisely managed times, providing more efficient combustion for better performance and reduced emissions. Then, by adding forced induction, a broad torque band is established across the entire rpm range for maximum output.



0 - 60 mph 6.0 seconds

10.3:1 - compression ratio

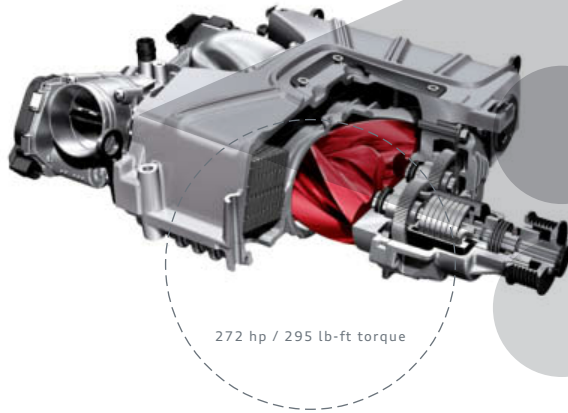

272 hp / 295 lb-ft torque



.14 - 2.0 TFSI Turbocharged Engine

Years ahead of the competition, the 2.0 TFSI engine gains all its power and efficiency from advanced technologies like direct injection and variable valve timing. Add in a turbocharger, and you get six-cylinder-like performance with four-cylinder efficiency.¹

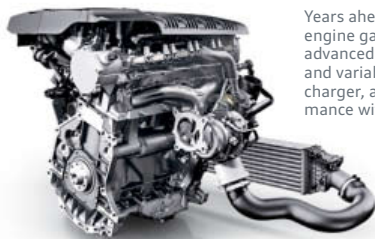

.15 - Start-Stop Engine Efficiency System

As an intelligent vehicle system, this highly effective engine management program can lower fuel consumption as well as CO₂ emissions by automatically shutting off the engine while you wait at a red light or perhaps during stop-and-go driving.¹ Once you are ready to resume, or if other critical vehicle systems require it, the engine will restart nearly instantaneously.³



Stay tuned for a dynamic transmission.

Many drivers mistakenly blame their engines for poor acceleration, when it's actually the transmission that isn't rising to the occasion. The Audi Q5 eliminates the problem with a revolutionary transmission. By utilizing optimized gear ratios, the eight-speed Tiptronic® automatic transmission is capable of delivering engine power in the most responsive and efficient way possible, all while allowing the driver to command upshifts or downshifts through the available steering-wheel-mounted shift paddles. Basically, it's the type of transmission one would expect from Audi.

.16 - Eight-speed Tiptronic® Automatic Transmission

As the perfect compromise between a dedicated manual and an automatic gearbox, the eight-speed Tiptronic® automatic transmission in the Audi Q5 offers eight optimized, carefully chosen gear ratios. Selected automatically or via its console-mounted shifter or steering wheel with available shift paddles, precise shifts are delivered without sacrificing the smooth action of the Tiptronic® automatic. A high final drive ratio allows optimization of lower gears, yet the transmission's upper range emphasizes fuel economy—particularly at highway speeds.¹

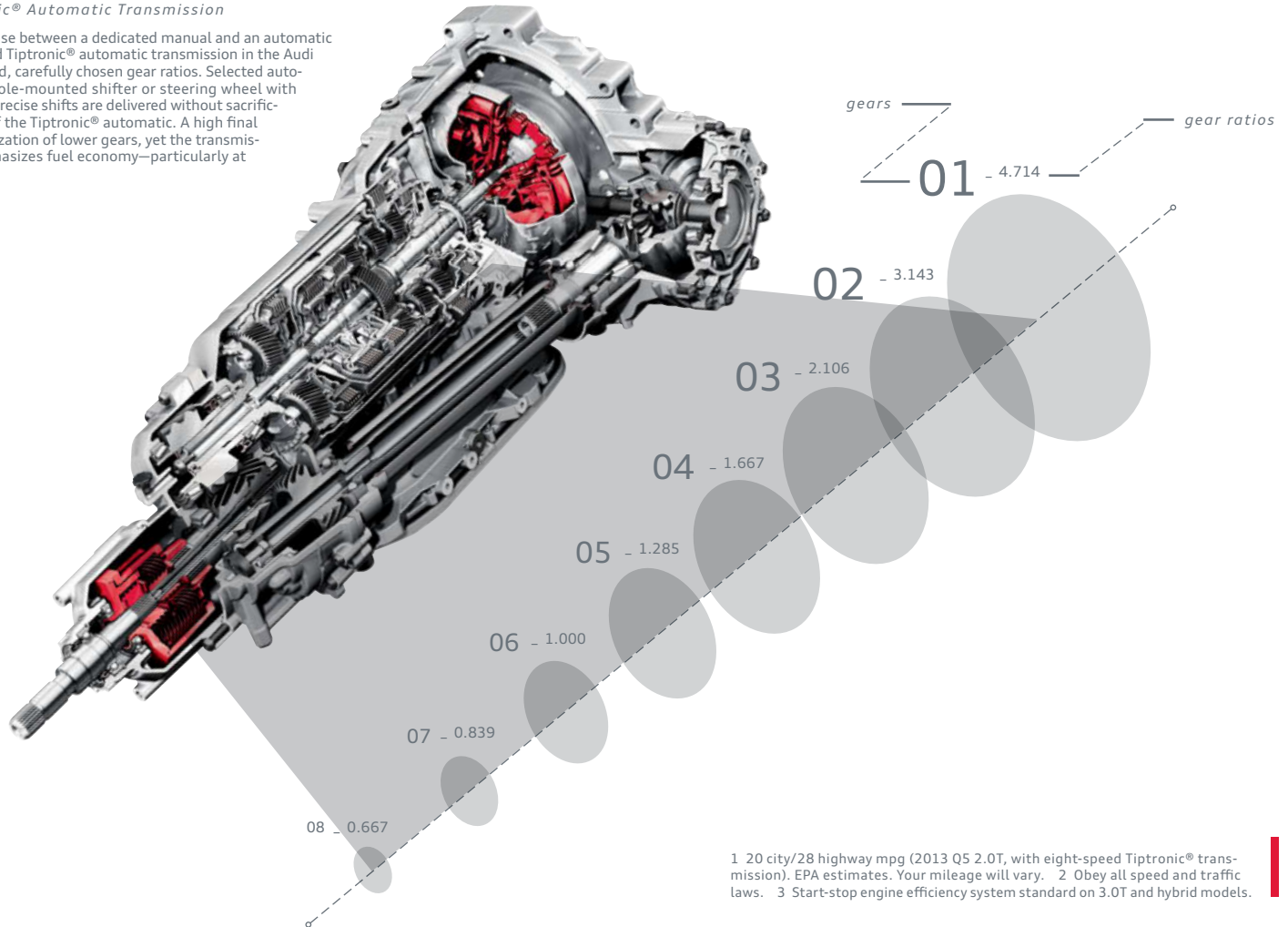

1 20 city/28 highway mpg (2013 Q5 2.0T, with eight-speed Tiptronic® transmission). EPA estimates. Your mileage will vary. 2 Obey all speed and traffic laws. 3 Start-stop engine efficiency system standard on 3.0T and hybrid models.

Part luxury. Part hybrid. All Audi.

The all-new Audi Q5 hybrid proves that performance doesn't have to take a back seat to efficiency.^{1,2} By coupling the legendary Audi 2.0-liter TFSI® engine with a 54-hp electric motor, the total combined system output jumps to 245 hp, ensuring that the Q5 hybrid lives up to the strict performance standards of Audi, all while achieving fuel efficiency that leaves other luxury SUVs stinging with jealousy.

.17 - Arctic Silver Metallic Paint



.18 - Hybrid Appearance

Setting the Q5 hybrid apart from its siblings are subtle, stylized visual effects. Hybrid badges grace the rear hatch, fenders and doorsills, while the signature Audi Singleframe® grille features a custom high-gloss black finish. Hybrid-specific 19" wheels round out its elegant look.



.19 - Exclusive 19" 10-spoke-turbine Design Wheels

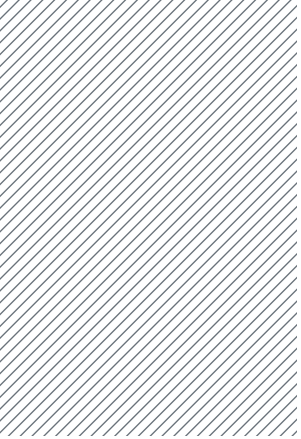

power

245 hp / 354 lb-ft of torque

.20 - 2.0 TFSI with quattro®

Even without the aid of the electric motor, the legendary Audi 2.0-liter TFSI engine is one formidable player. Add in the instant torque of the 54-hp electric motor and the legendary handling of Audi quattro® all-wheel drive, and it becomes a powerhouse beyond compare.

6.8 seconds 0 - 60 mph

power

266 volts / 1.3kWh energy

.21 - Lithium-ion Battery System

The advanced lithium-ion battery used in the Q5 hybrid serves as the energy storage unit for the electric motor. Its large energy reserves combined with the high-output 54-hp electric motor allows for full electric driving at speeds of up to 62 mph.

battery weight 81 lb

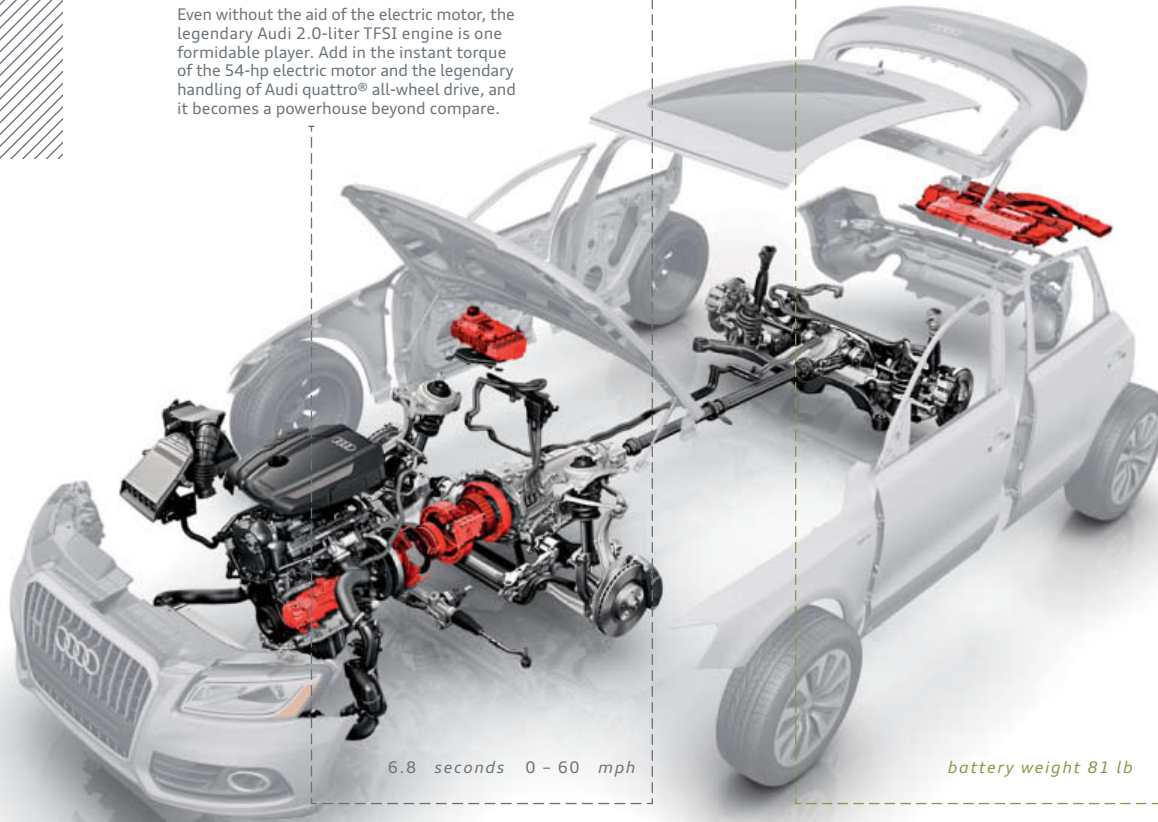

.22 - Sailing Mode

The Q5 hybrid features a unique hydraulic clutch between the engine and electric motor that disengages the engine when you lift off the accelerator at highway cruising speeds. The electric motor then takes over to propel the vehicle until more acceleration is needed. Called "sailing," the benefit is a gain in highway fuel economy, a result not typically associated with hybrids.¹

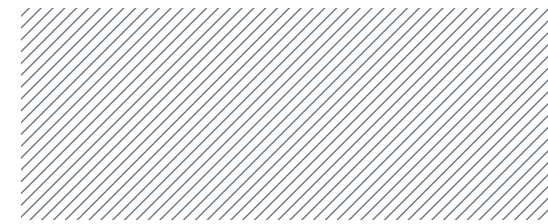

¹ 24 city/30 highway mpg (2013 Q5 hybrid with eight-speed Tiptronic® automatic transmission). EPA estimates. Your mileage will vary.
² The Q5 hybrid is available in the U.S. in limited quantities and only at participating Audi dealers.

Saving fuel, even if you're too comfortable to notice.

When you're wrapped in this kind of luxury, you'll be forgiven for not thinking about how efficiently you're getting from place to place.¹ Settling into the driver's seat, you'll quickly notice how much thought has gone into keeping you informed of the hybrid system's performance. Directly in front of you is the power meter, which helps track your efficiency as you drive, while up-to-the-second hybrid drive-system information is displayed on the MMI® screen in case you need a gentle reminder of just how impressive a performance hybrid can be.



2013 Audi Q5 hybrid shown in Black leather.

.23 - Power Meter

Taking the place of the tachometer, the power meter displays the hybrid system's total power output, providing efficiency information in real time.



driving status

battery charge indicator



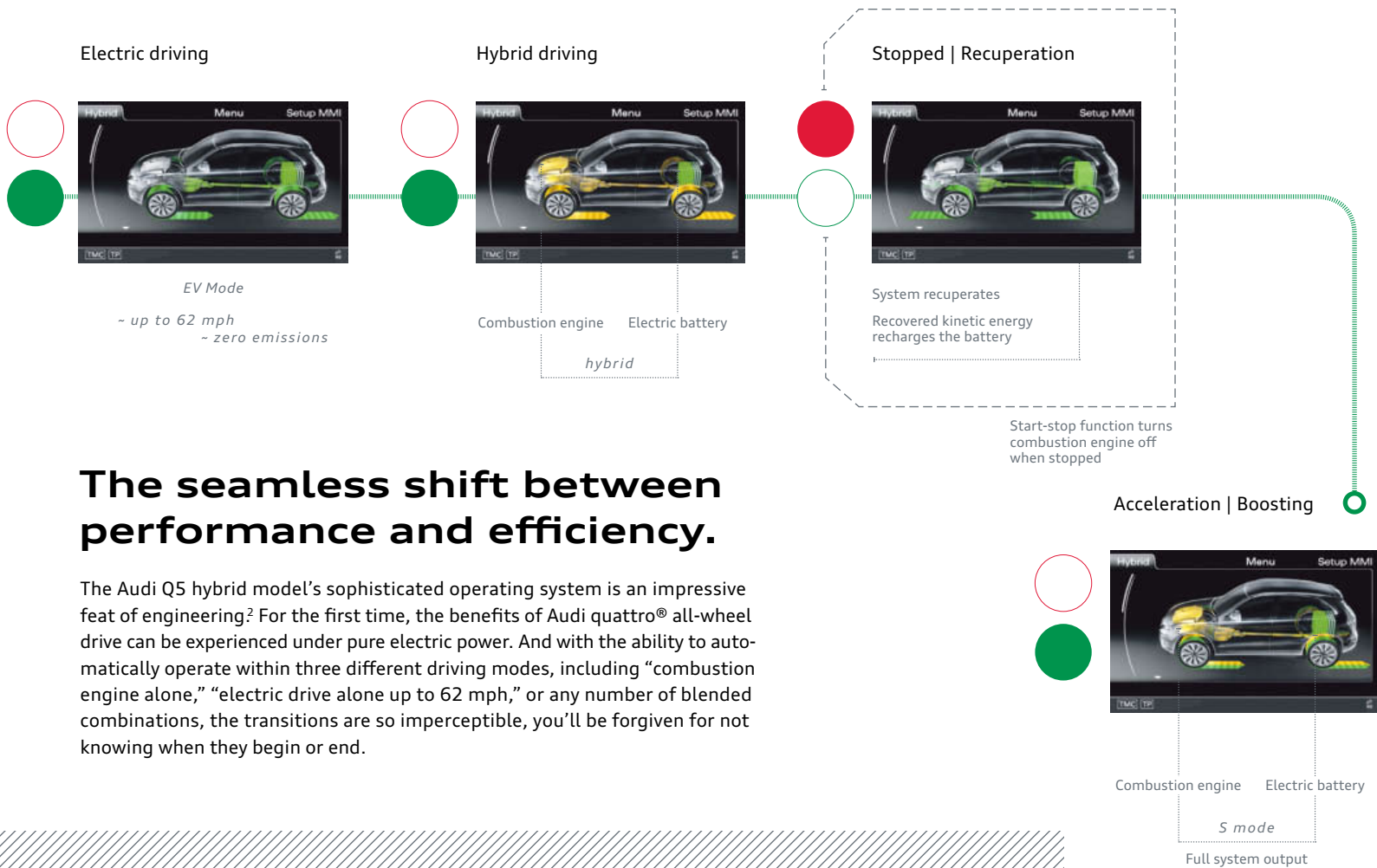

The seamless shift between performance and efficiency.

The Audi Q5 hybrid model's sophisticated operating system is an impressive feat of engineering.² For the first time, the benefits of Audi quattro® all-wheel drive can be experienced under pure electric power. And with the ability to automatically operate within three different driving modes, including "combustion engine alone," "electric drive alone up to 62 mph," or any number of blended combinations, the transitions are so imperceptible, you'll be forgiven for not knowing when they begin or end.

¹ 24 city/30 highway mpg (2013 Q5 hybrid, with eight-speed Tiptronic® transmission). EPA estimates. Your mileage will vary. ² The Q5 hybrid is available in the U.S. in limited quantities and only at participating Audi dealers.

Anticipating needs you didn't know you had.

Available driver-assistance technologies take into account the actions of other drivers—while making your drive a little easier. From seemingly sentient Audi adaptive cruise control to Audi side assist, the Audi Q5 incorporates innovative, anticipatory technologies that don't see your future so much as help change it.

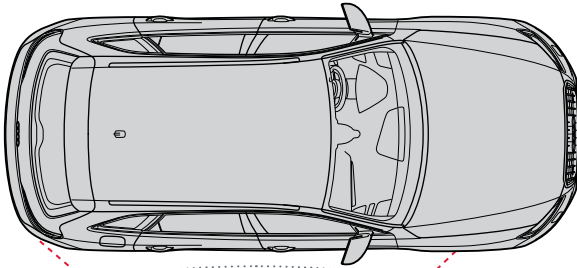

.24 - Audi Side Assist

The available Audi side assist uses radar sensors and two different optical warnings to help keep the driver informed of what is approaching from hard-to-see angles behind and to the side of the vehicle.

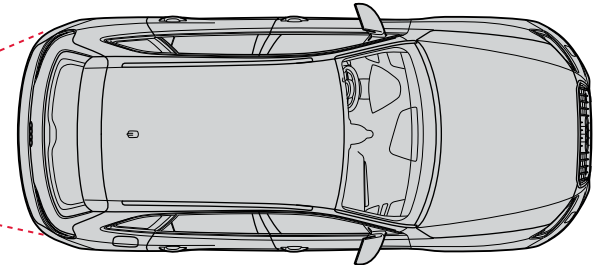
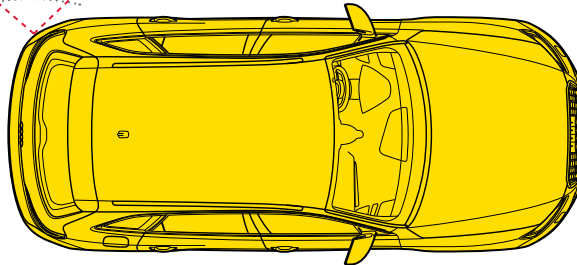

.25 - Audi Adaptive Cruise Control

Everyone has their own comfort zone. The available Audi adaptive cruise control helps maintain a driver-selected distance from the vehicle in front using a special long-range radar sensor. The system constantly measures the space between your vehicle and the vehicle ahead and helps maintain it by automatically adjusting your speed. Once the road ahead is clear, the vehicle effortlessly resumes the previously preset speed, helping to make your drive that much more relaxing.



Helping to see the unforeseen.

Whether it's helping to avoid an accident before it ever happens or helping protect its occupants in the event of an unavoidable collision, the Audi Q5 consistently rises to the occasion. This is evident through its advanced braking technologies that help maintain control, as well as the use of high-strength steel that helps add a measure of security while enhancing overall handling performance.¹ Add in six standard airbags and its commitment to your well-being becomes even more apparent.



.26 - Six Standard Airbags

With six standard airbags, including front-impact and thorax side airbags for both driver and front passenger, and available rear passenger thorax side airbags, you'll feel practically surrounded.² And that's a good thing.

Dramatization²

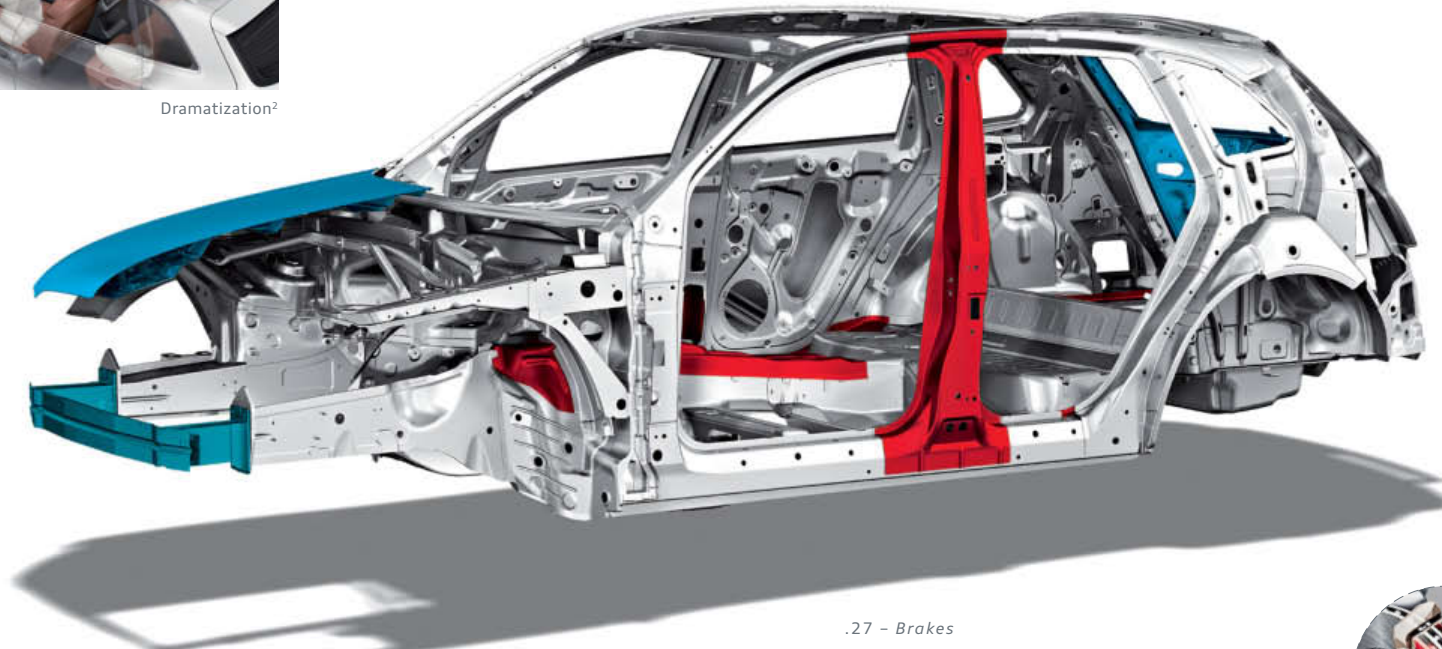

.27 - Brakes

Whether you're on the open road or off the beaten path, ESC with ABS helps to keep the vehicle traveling in its intended direction by applying the right brakes at the right time to help maintain better traction, minimize skids, and optimize control.



¹ Airbags are supplemental restraints only and will not deploy under all crash circumstances. Always use safety belts and seat children only in the rear, using restraint systems appropriate for their size and age. ² This is a dramatization and does not depict what will happen in a collision. All bags will not inflate in real-world collisions, and, if multiple bags do deploy, they will be in various stages of inflating/deflating and will never all be inflated at the same time.

The functional equivalent of installing a brain in your car.

Nothing in your Audi Q5 was built in isolation. What we mean is that design, engineering and technology were conceived as a seamless whole—that they are all integrated and functional. You can see that philosophy fully represented in the available Audi MMI® system. Simply put, it's an intuitive system that intimately connects you to almost every facet of the vehicle. It's the nerve center of your vehicle, allowing you to control virtually every interior function of your Q5 with a simplified source control button system. From the Audi MMI Navigation plus, to the radio, to media, the MMI helps you access information with a few easy clicks or voice commands. You can even pair your compatible BLUETOOTH® enabled phone with the system for added convenience. We think of these things so you can think about how good your drive feels.

.29 - *Function Buttons*

Helping you navigate through the MMI system with ease are four well-placed function buttons. Each button correlates to a command at the corner of the screen, and, when pressed, takes you to your desired selection.

.28 - *Audi MMI Navigation plus*

Count on the available advanced navigation system to home in on your destination with stunning precision while putting a little more depth in your journey with help from Google Earth™.¹

.30 - *SiriusXM Satellite Radio*

Go ahead. Crisscross the country. We assure you, you'll never run out of entertainment options, with over 130 channels of music, talk and news.¹



.31 - *BLUETOOTH® Technology*

Unlock your mobile phone's potential through the MMI system. Simply pair them up and start enjoying near complete control at the touch of a button.²



menu button

Choose your path of least resistance.

back button

Takes you back to the previous screen or task.

car button

Customize your Audi Q5 through the MMI.



.32 - *Audi Audio*

The media button opens up a world of options, allowing you to control the available Audi music interface, Secure Digital (SD) card slots, hard disk drive (HDD) audio jukebox or DVD player.

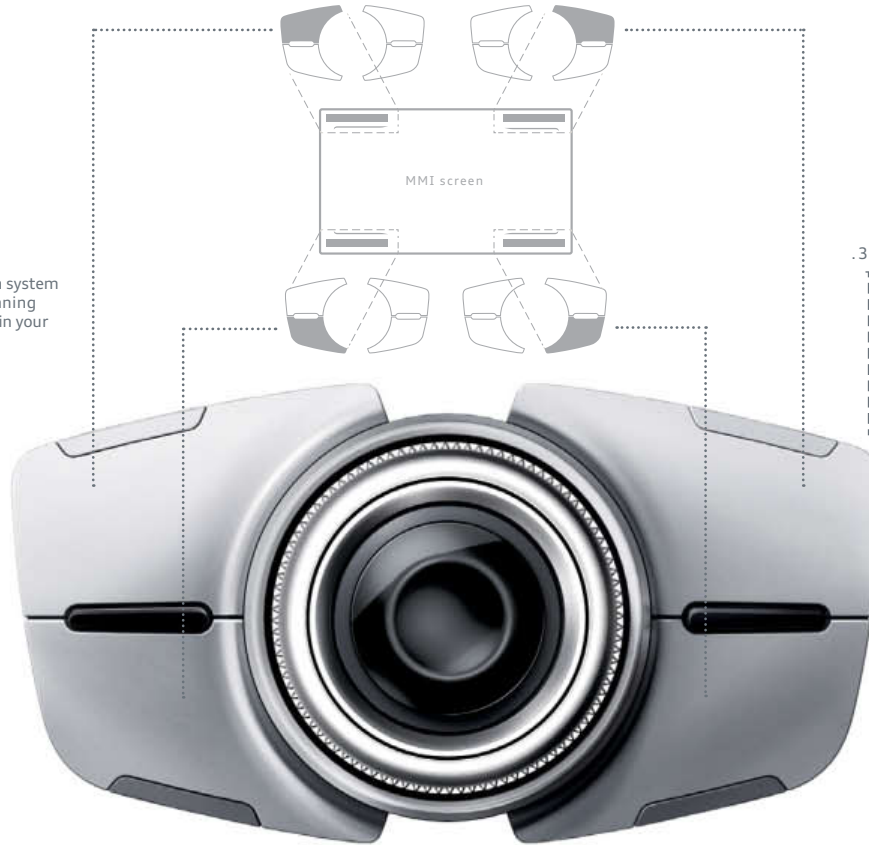

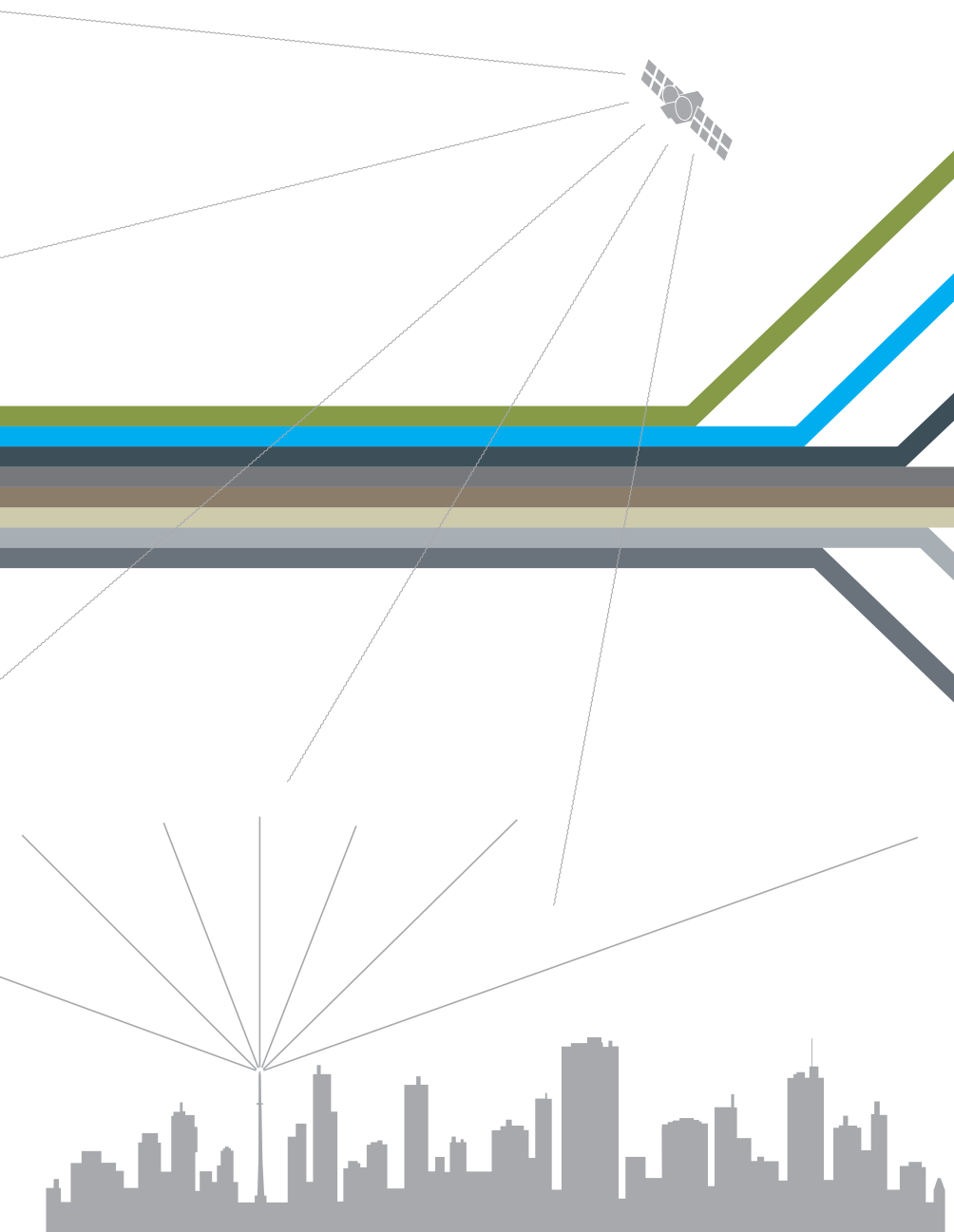

- Google Earth™ 3D satellite imagery**
With Google Earth™ integration, you'll enjoy 3D topography, including Google Maps Street View, displayed right on the Audi MMI® screen.
- SiriusXM Traffic**
Working with your Google Earth™ overlay, you can get traffic conditions and plan alternate routes to help get around traffic backups.²
- Reported local fuel prices**
Find the lowest reported local price for fuel—and the directions to the station—right through the MMI system.
- Google™ Local Search**
Search for destinations via text or voice, using the cloud processing power of Google™ speech recognition and their point-of-interest database.
- myAudi features**
Plan your destination from your personal computer and send your route to your Q5, for a preprogrammed trip plan.
- Weather information**
Current local conditions and forecasts for your destination can help you prepare for your trip.
- News feeds**
Stay on top of the news by having headlines and stories delivered right to your MMI display.
- Mobile Wi-Fi hotspot**
Provides high-speed connectivity for up to eight passenger devices through an onboard wireless hub.

Orchestrating a new way of listening.

In some respects, you haven't heard anything yet. But with the available 14-speaker Bang and Olufsen® sound system, you'll hear things in a way you've never heard anything before. It's at the heart of what Audi sound engineers had in mind for the Q5. We actually remapped the listening process to help ensure that the sounds are hitting your ears at the precise time and acoustic levels that your music was intended to have. Which means the volume and timbre are automatically adjusted to changing ambient noise levels, to deliver the optimized clarity of the notes and sounds you want to hear. So that's why when we say "Truth in Engineering" you might just hear what we're talking about.



.33 - Concert Hall Effect

The human ear can detect the direction that sound is coming from only when it is high-frequency, so the cabin speakers are evenly balanced with high- and mid-range speakers. Since the ear cannot detect the direction of low-frequency or bass notes, a single subwoofer complements the sound throughout the cabin, giving you the concert hall experience anywhere your drive might take you.

- | | |
|---------------------------|----------------------------|
| 1. Center mid-range | 8. Rear 260-mm bass woofer |
| 2. Right mid-range | 9. Left surround speaker |
| 3. Right tweeter | 10. Left 168-mm woofer |
| 4. Right 200-mm woofer | 11. Left tweeter |
| 5. Right tweeter | 12. Left 200-mm woofer |
| 6. Right 168-mm woofer | 13. Left tweeter |
| 7. Right surround speaker | 14. Left mid-range |

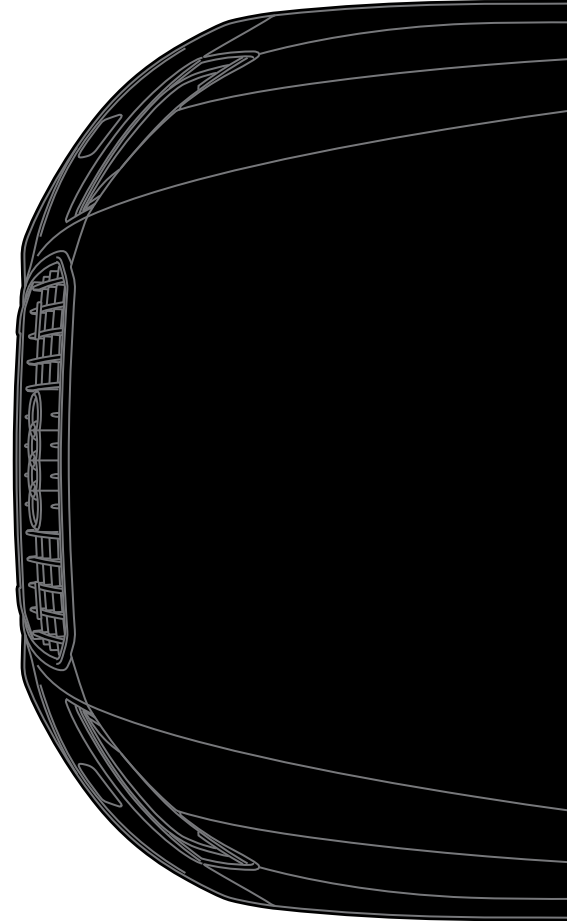

14

speakers

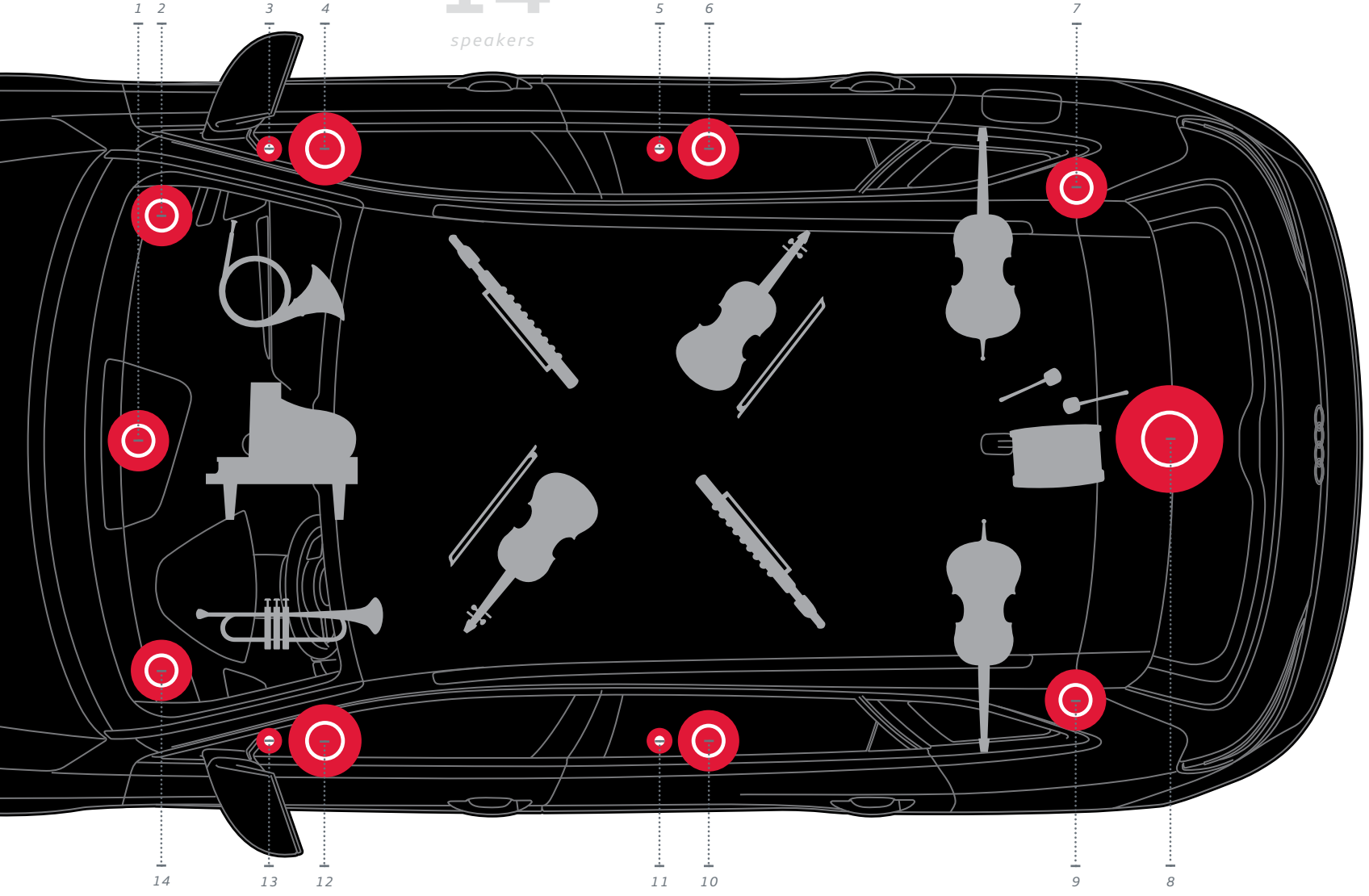



2013 Audi Q5 2.0T Premium plus shown in Ice Silver metallic with optional 19" 5-double-spoke design wheels.

Proof that an exit can be just as dramatic as an entrance.

Just in case someone didn't catch a glimpse of its striking front end or graceful side profile, the Audi Q5 offers two powerful last takeaways. Signature LED taillight technology that is as brilliant as it is unmistakably Audi, and a pair of beautifully sculpted flat-bottom exhaust outlets perfectly integrated into the lower bumper. It all adds up to a truly memorable combination that puts this luxury SUV in a class of its own.

.34 - LED Taillight
Technology



~ fig. 08

Sleek and stylish, these rear light-emitting diodes are brighter and longer-lasting than conventional bulbs and illuminate faster than traditional brake lights, which can help give the driver behind you more time to respond.

Exterior Colors

Brilliant Black

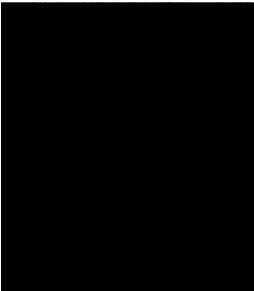

Ibis White

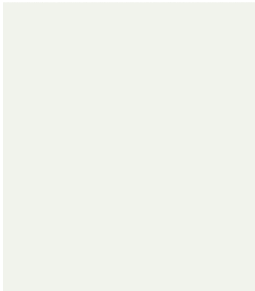

Arctic Silver metallic

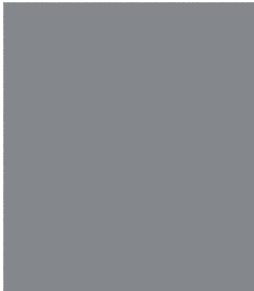

Cuvée Silver metallic

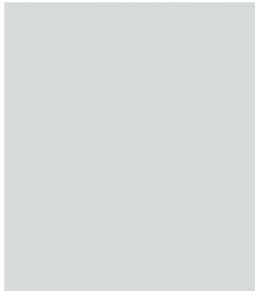

Glacier White metallic

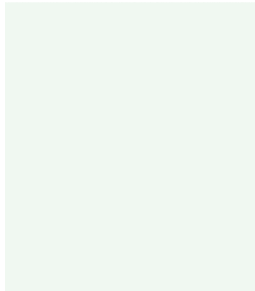

Ice Silver metallic

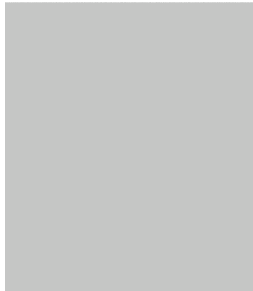

Q5 hybrid exclusive

Monsoon Gray metallic



Moonlight Blue metallic



Scuba Blue metallic



Teak Brown metallic

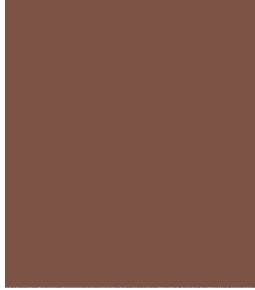

Phantom Black pearl



Interior Colors | Seat Selections



Standard Seat



Comfort Seat



Sport Seat

Black leather



Chestnut Brown leather



Black Perforated leather



Chestnut Brown Perforated leather



Black leather



Chestnut Brown leather



Pistachio Beige leather



Titanium Gray leather

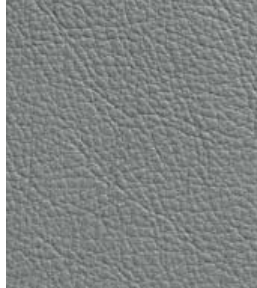

Pistachio Beige Perforated leather



Titanium Gray Perforated leather

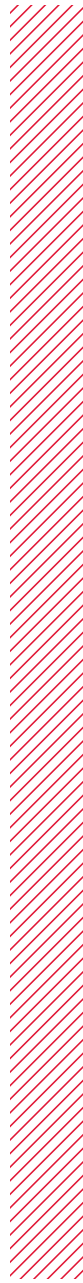
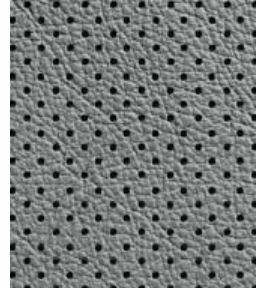

Decorative Inlays



Dark Brown Walnut
Wood inlay



Aluminum Dimension inlay¹

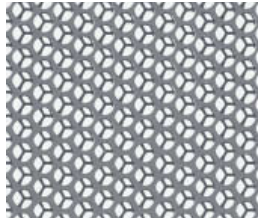

Fine Grain Ash Natural
Brown Wood inlay¹

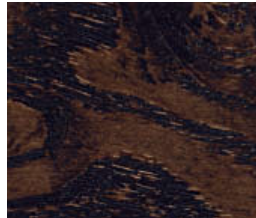

Layered Oak Wood inlay¹



Brushed Aluminum inlay¹



Audi S line®

¹ Decorative inlay options will vary based on model and interior color combination. See your dealer for details.

Wheels

18" 5-spoke-V design
235/60 all-season tires



Q5 2.0T Premium

19" 5-double-spoke design
235/55 all-season tires



Q5 2.0T Premium plus (optional)
Q5 3.0T Premium plus and Prestige

20" 5-arm design
255/45 summer performance tires²



Audi S line® package

20" 5-double-spoke off-road design
255/45 summer performance tires²



Q5 3.0T Premium plus and Prestige (optional)

19" 10-spoke-turbine design
235/55 all-season tires



Q5 hybrid

20" 10-spoke-turbine design
Anthracite finish
255/45 summer performance tires²



Q5 hybrid (optional)

19" 5-arm off-road design
235/55 all-season tires



Q5 hybrid (optional)

² Tires are supplied and warranted by their manufacturer. High-performance tires are designed for optimum performance and handling in warm climates. They are not suitable for cold, snowy, or icy weather conditions. If you drive under those circumstances, you should equip your vehicle with all-season or winter tires, which offer better traction under those conditions. We suggest you use the recommended winter or all-season tire specified for your car or its equivalent. These high-performance tires also have a lower aspect ratio that aids performance and handling; however, in order to avoid tire, rim or vehicle damage, it is important that the inflation pressure is regularly checked and maintained at optimum levels. Please also remember in making your selection that, while these tires deliver responsive handling, they may ride less comfortably and make more noise than other choices. Finally, these tires may wear more quickly than other choices.

Technical Specifications

Engineering Performance	Q5 2.0T	Q5 3.0T	Q5 hybrid
Engine type	Four-cylinder	Six-cylinder	Four-cylinder
Engine block/Cylinder head	Cast-iron/Aluminum-alloy	Aluminum-alloy	Cast-iron/Aluminum-alloy
Displacement (cc)/Bore and stroke (mm)	1,984/82.5 x 92.8	2,995/84.5 x 89.0	1,984/82.5 x 92.8
Horsepower (@ rpm)	211 @ 4,300	272 @ 4,780	245 ¹ @ 4,300
Torque (lb-ft @ rpm)	258 @ 1,500	295 @ 2,150	354 ¹ @ 1,500
Compression ratio	9.6:1	10.3:1	9.6:1
Valvetrain	16-valve DOHC with valvelift system	24-valve DOHC with variable valve timing	16-valve DOHC with valvelift system
Induction/Fuel injection	Turbocharged/TFSI®	Supercharged/TFSI®	Turbocharged/TFSI®
Start-stop efficiency system	—	■	■
54-hp water-cooled three-phase hybrid AC electric motor/generator	—	—	■
266-volt, 72-cell, lithium-ion hybrid system battery	—	—	■
Acceleration (0–60 mph)	7.0 seconds	6.0 seconds	6.8 seconds
Top track speed ²	130 mph	130 mph	130 mph

Transmission Drivetrain	Q5 2.0T	Q5 3.0T	Q5 hybrid
Eight-speed Tiptronic® automatic transmission with Audi quattro® all-wheel drive	■	■	■
Gear ratios: 1st: 4.714, 2nd: 3.143, 3rd: 2.106, 4th: 1.667, 5th: 1.285, 6th: 1.000, 7th: 0.839, 8th: 0.667, Reverse: 3.317, Final Drive: 3.760 (3.204 for 3.0T models)	■	■	■

Body Suspension Chassis	Q5 2.0T	Q5 3.0T	Q5 hybrid
Fully galvanized steel unibody with multistep anti-corrosion protection—aluminum hood and tailgate	■	■	■
Five-link front suspension with stabilizer bar	■	■	■
Trapezoidal-link rear suspension	■	■	■
Adaptive damping suspension	—	SL	—
Electromechanical power steering system	■	■	■
Dynamic steering	—	DA	—
Steering ratio	15.9:1	15.9:1	15.9:1
Turning diameter, curb-to-curb (ft)	38.1	38.1	38.1

■ Standard
— Not applicable

NA Information not available at time of printing

CF Comfort package

NV Audi MMI® Navigation package

CP Convenience package

SL Audi S line® package

DA Driver Assist package

SI Sport Interior package

LP Lighting package

Exterior measurements	Q5 2.0T	Q5 3.0T	Q5 hybrid
Wheelbase (in)	110.5	110.5	110.5
Length (in)	182.6	182.6	182.6
Height (in)	65.2	65.2	65.0
Width with mirrors (in)	82.2	82.2	82.2
Width without mirrors (in)	74.7	74.7	74.7
Track (in, front/rear)	63.7/63.5	63.7/63.5	63.7/63.5
Ground clearance, loaded (in)	7.9	7.9	7.9
Curb weight (lb)	4,079	4,345	4,431
Drag coefficient (Cw)	0.33	0.33	0.33
Trailer hitch provision with 4,400 lb maximum towing capacity and 440 lb tongue weight ³	■	■	■

Interior measurements			
Headroom (in, front/rear)	39.4/39.0	39.4/39.0	39.4/39.0
Legroom (in, front/rear)	41.0/37.4	41.0/37.4	41.0/37.4
Shoulder room (in, front/rear)	57.7/56.4	57.7/56.4	57.7/56.4
Cargo volume (cu ft, std/rear seat folded)	29.1/57.3	29.1/57.3	29.1/57.3
Seating capacity	5	5	5

EPA mileage estimates Capacities			
Tiptronic® automatic transmission (city/highway/combined) ⁴	20/28/23	NA ⁵	24/30/26
Engine oil (qt)	4.8	7.2	4.8
Fuel (gal)	19.8	19.8	19.0
Recommended fuel	Premium	Premium	Premium

1 Combined gasoline engine and electric motor output. 2 Top track speed is electronically limited in the U.S. Obey all speed and traffic laws. 3 When properly equipped. See owner's manual for details. 4 EPA estimates. Your mileage will vary. 5 EPA estimates not available at time of printing. Your mileage will vary.

Featured Content

Safety Security	Premium	Premium plus	3.0T Prestige/hybrid
Driver and front passenger dual-stage airbags, thorax side airbags and Sideguard® head curtain airbags ¹	■	■	■
Rear-passenger thorax side airbags ¹	Optional	Optional	Optional
Front passenger occupant detection—for airbags	■	■	■
Safety belt reminder for driver and front passenger	■	■	■
Lower Anchors and Tethers for CHildren (LATCH) in rear seats	■	■	■
Power central locking system with safety unlock feature if airbags deploy	■	■	■
Electronic Stability Control (ESC) with traction control (ASR) and off-road mode	■	■	■
Anti-lock Brake System (ABS) with Electronic Brake-pressure Distribution (EBD) and brake assist	■	■	■
Tire-pressure monitoring system	■	■	■
Anti-theft alarm system with panic function	■	■	■

Exterior	Premium	Premium plus	3.0T Prestige/hybrid
Audi Singleframe® grille	■	■	■
Halogen headlights with daytime running lights	■	—	—
Xenon plus headlights with LED daytime running light technology	LP	■	—
Adaptive xenon plus headlights with turning light and LED daytime running light technology	—	—	■
Automatic headlights	■	■	■
Headlight washing system	—	■ (3.0T)	■/—
Front and rear fog lights	■	■	■
LED taillight technology	■	■	■
Power-adjustable, heated exterior side mirrors	■	—	—
Power-adjustable, power-folding, auto-dimming, heated exterior side mirrors with memory	—	■	■
LED turn indicator light technology in the side mirrors	■	■	■
Heated windshield washer nozzles	■	■	■
Aluminum roof rails	■	■	■
Aluminum trim around exterior windows	■	■	■
Power tailgate	—	■	■
Flat-bottom dual exhaust outlets with polished tips	■	■	■
Audi S line® exterior appearance	—	■ (3.0T)	■/—

■ Standard
— Not applicable

NA Information not available at time of printing

CF Comfort package

NV Audi MMI® Navigation package

CP Convenience package

SL Audi S line® package

DA Driver Assist package

SI Sport Interior package

LP Lighting package

Interior

	Premium	Premium plus	3.0T Prestige/hybrid
Three-zone automatic climate control	■	■	■
Four-spoke multifunction steering wheel	■	■	■
Three-spoke multifunction steering wheel with shift paddles	—	SI	SI
Three-spoke flat-bottom multifunction steering wheel with shift paddles	—	SL (3.0T)	SL/—
Tilt and telescopic manually adjustable steering column	■	■	■
Decorative interior inlays ²	■	■	■
Thermo cupholder	—	—	■
Black cloth headliner	With Chestnut Brown leather	With Chestnut Brown leather or SL (3.0T)	With Chestnut Brown leather or SL (3.0T)
Dual front sun visors with lighted vanity mirrors	■	■	■
Manual rear side sunshades	—	—	■
Rear cargo cover, tilts when tailgate is opened	■	■	■
Power windows with one-touch up/down operation and pinch protection	■	■	■
Panoramic sunroof	Optional	■	■
Panoramic sunroof deletion	—	Optional	Optional

Seating

Leather seating surfaces	■	■	■
Milano leather seats with stitched door armrests and instrument panel top in Fine Nappa leather	—	—	CF
Eight-way power front seats and four-way power lumbar adjustment for driver	■	■	■
Twelve-way power front sport seats, including four-way power lumbar adjustment	—	SI	SI
Driver seat memory	—	■	■
Heated front seats	Optional	■	■
Ventilated front seats	—	—	CF
Sliding 40/20/40 split folding rear seat with pass-through and adjustable recline	■	■	■

¹ Airbags are supplemental restraints only and will not deploy under all crash circumstances. Always use safety belts and seat children only in the rear, using restraint systems appropriate for their size and age. ² See Decorative Inlays page for more details. Decorative inlay options will vary based on model and interior color combination. See your dealer for details.

Featured Content

Infotainment Technology	Premium	Premium plus	3.0T Prestige/hybrid
Audi MMI® Navigation plus with voice control system ¹	—	NV	■
Audi connect™ with six-month trial subscription ²	—	NV	■
Driver information system	■	■	—
Color driver information system	—	NV	■
Audi concert radio with ten speakers and single CD player with MP3 playback capability	■	■	—
Bang & Olufsen® Sound System with 14 speakers and 505 watts	—	Optional	■
HD Radio™ Technology	—	NV	■
SiriusXM Satellite Radio with 90-day trial subscription ³	■	■	■
SiriusXM Traffic with four-year subscription ³	—	NV	■
Audi music interface with iPod® integration	CP	■	■
Rear Seat Entertainment with dual 9" screens and individual DVD players	Optional	Optional	Optional
BLUETOOTH® wireless technology preparation for mobile phone	CP	■	■
Garage door opener (HomeLink®)	CP	■	■
Audi advanced key—keyless start, stop and entry ⁴	—	Optional (2.0T)/ ■ (3.0T)	■
Cruise control with coast, resume and accelerate features	■	■	■
Audi adaptive cruise control	—	—	DA/—
Audi side assist	—	—	■
Audi drive select	—	SL (3.0T)	DA,SL/—
Hill descent control	■	■	■
Audi parking system plus with rear view camera	—	NV	■
Rain/light sensor for automatic windshield wipers and headlights	■	■	■

■ Standard
— Not applicable

NA Information not available at time of printing

CF Comfort package

NV Audi MMI® Navigation package

CP Convenience package

SL Audi S line® package

DA Driver Assist package

SI Sport Interior package

LP Lighting package

¹ Audi Navigation plus depends on signals from the worldwide Global Positioning Satellite network. The vehicle's electrical system and existing wireless and satellite technologies must be available and operating properly for the system to function. The system is designed to provide you with suggested routes in locating addresses, destinations and other points of interest. Changes in street names, construction zones, traffic flow, points of interest and other road system changes are beyond the control of Audi of America, Inc. Complete detailed mapping of lanes, roads, streets, toll roads, highways, etc., is not possible, therefore you may encounter discrepancies between the mapping and your actual location. Please rely on your individual judgment in determining whether or not to follow a suggested Audi Navigation plus route. Periodically mapping updates will be available for purchase at an additional cost. Consult your dealer or call 1-800-FOR-AUDI for details. ² See Audi connect page for important information regarding Audi connect. ³ SiriusXM Satellite Radio and Traffic subscriptions sold separately or as a package after trial expires. SiriusXM Traffic service available in select markets. Subscriptions are governed by SiriusXM Customer Agreement (see www.siriusxm.com) and are continuous until you call SiriusXM to cancel. SiriusXM U.S. Satellite Service available only to those 18 and older in the 48 contiguous U.S.A., D.C. and Puerto Rico (with coverage limitations). ⁴ Some Audi models are equipped with a keyless ignition feature. The details as to how the system works can vary, and Audi owners should consult their owner's literature or an authorized Audi dealer if they have further questions about the operation of this feature. Please note that Audi warns against leaving the vehicle unattended with the engine running, particularly in enclosed spaces.

A pinnacle of style just reached new heights.

Take the Audi Q5 3.0T, a vehicle already emanating style. Add in Audi S line® exterior features like a specialized front grille, more aerodynamic front and rear bumpers, and stunning 20" 5-arm design wheels. Then step it up on the inside with a three-spoke flat-bottom multifunction steering wheel with shift paddles, a beautifully crafted S line shift knob, Brushed Aluminum inlays, and a full-length black cloth headliner. Now it's quite obvious, style just hit its peak.



2013 Audi Q5 3.0T Prestige shown in Monsoon Gray metallic with the available Audi S line® package.

Accessories

Imagine a cherry on top of your sundae. Sweet, right? Now imagine a cherry that helps protect your Audi Q5 in the garage. Or carries your bikes for a serious weekend on the trails. Or makes heads turn as you drive by. Audi Genuine Accessories are the little extras that make your Audi even sweeter. Designed by the same



20" Nevis Alloy Wheel—Polished Silver

Add a more powerful, sporty look with this eye-catching design.

20" Dinara Alloy Wheel

Give this vehicle a more unique presence with this Audi designed alloy wheel.



Aluminum Bike Rack^{2,3}

This locking holder fits 20- to 80-mm bike frames with both wheels on the bike and helps keep the bike upright as you secure it in place.

Compact Cargo Carrier²

A trim, aerodynamic design that offers a generous 16.95-cu-ft capacity. Size: 81" long, 30" wide, 15" high.



Other accessories not shown -----

Audi Genuine Sport and Design Accessories

Your Audi vehicle features a bold, aggressive stance and strong, stunning lines. Enhance it by adding Audi Genuine Sport and Design Accessories. All are carefully scrutinized in the design and development process. So while they're striking in appearance, they've also passed rigorous quality assessments. If you're looking for a bolder appearance or a finishing touch, there is a solution designed by Audi that makes every mile more enjoyable—and more yours.

Audi Genuine Alloy Wheels

Strike the perfect balance between breathtaking design and awe-inspiring performance with Audi Genuine Alloy Wheels. Audi experts have meticulously designed these wheels especially for each Audi model. They're engineered to the highest standards and endure rigorous testing to help ensure long-term quality. Experience eye-catching style that is yours and yours alone. Nothing enhances the bold, dynamic look of your Audi vehicle faster.

1 See dealer for details. 2 All roof-rack system attachments require the base carrier bars. All attachments sold separately. 3 Recreational equipment, sporting equipment and luggage not included.

visionaries who designed your vehicle, all accessories feature a tailored fit and the expert craftsmanship you'd expect from Audi. They are also backed by the 4-year/50,000-mile Audi New Vehicle Limited Warranty or the accessory's 12-month/12,000-mile limited warranty, whichever extends longer from the accessory purchase date.¹



Ski and Snowboard Racks^{2,3}

Push-button, keyed locks open and close easily. Rubber-cushioned aluminum bars hold securely. Standard attachment holds up to four skis or two snowboards. Deluxe attachment holds up to six skis or four snowboards.

Watersports Racks^{2,3}

Carries one canoe, kayak or surfboard only. Holds up to 55 lb and includes one pair of heavy-duty straps.

Audi TravelSpace Transport Accessories

You go almost everywhere. Give your Audi the proper invitation to be part of your adventures. Never leave the necessary gear behind. Bring it with Audi TravelSpace Transport Accessories. The list includes bike racks, ski racks, a variety of watersports equipment carriers and various sizes of cargo carriers. Wherever you go, make sure almost everything fits with a variety of intelligent and innovative solutions. Accessories designed for your life—the passionate, active part.

Textile Floor Mats

These skid-resistant, precision-fit mats are made of long-life fabric to help protect the vehicle's interior from the elements. Black mats are available in a set of four.

All-weather Floor Mats

Nubbed design helps protect the floor and carpeting from water, mud, sand and snow. Black rubber mats feature the vehicle logo and are available in a set of four.

Audi Genuine Electronics Accessories

The illuminating technology that graces each Audi vehicle provides the inspiration for Audi Genuine Electronics Accessories. Similarly, all of these accessories are impressively advanced and inspiring. Our audio options let you enhance your listening pleasure. Other accessory options help promote safer, more convenient travel. All are designed and tested to help ensure compatibility with the vehicle's electrical systems, allowing you to enjoy every aspect of Audi technology with almost all your senses. Demand the best and drive with added confidence.

All-weather Trunk Liner

Custom fit for the Q5. Textured material helps control load-shifting. Raised lip helps contain spills and protect cargo-area carpeting from stains.

Umbrella Case

This umbrella holder fits on the hook on the passenger side of the center console for easy access. Includes Audi pocket umbrella.

Audi Guard Comfort and Protection Accessories

Protect what you love. Audi Guard Comfort and Protection Accessories offer functional, practical items that help keep your Audi in pristine condition. Choose from trunk liners that help make clean-up quick and easy, to an easy-to-use storage cover that helps shield the vehicle. Use them all to reduce wear and tear, and help keep the vehicle looking like new—inside and out. All are engineered to stringent Audi standards, so you can be assured of the quality and durability demanded by Audi drivers.

Q5

2013 | Q5

Audi of America
Audiusa.com
Facebook.com/Audi

Note: A word about this brochure. Audi of America, Inc., believes the specifications in this brochure to be correct at the time of printing. However, specifications, standard equipment, options, fabrics, and colors are subject to change without notice. Some equipment may be unavailable when your vehicle is built. Please ask your dealer for advice concerning current availability of standard and optional equipment, and your dealer will verify that your vehicle will include the equipment you ordered. Vehicles in this brochure are shown with optional equipment. See your dealer for complete details on the New Vehicle Limited Warranty, twelve-year limited warranty against corrosion perforation, and Audi 24/7 Roadside Assistance. (Roadside assistance coverage provided by Road America in the U.S. Certain conditions apply; see your dealer for details.) Tires supplied by various manufacturers. "Audi," all model names, "Audi connect," "FSI," "MMI," "quattro," "Sideguard," "Singleframe" and the Singleframe grille design, "S line," "TFSI," "Truth in Engineering," and the four rings logo are trademarks or registered trademarks of AUDI AG. "Bang & Olufsen" is a registered trademark of Bang & Olufsen. The BLUETOOTH word mark and logos are owned by the Bluetooth SIG, Inc., and use of any such marks by AUDI AG is under license. "GOOGLE" and "Google Earth" are trademarks of Google Inc. "HD Radio" and the HD Radio logo are proprietary trademarks of iBiquity Digital Corporation. "HomeLink" is a registered trademark of Johnson Controls Technology Company. "iPod" is a registered trademark of Apple Inc. "SiriusXM" and all related marks and logos are trademarks of SiriusXM Radio Inc. and its subsidiaries. "Tiptronic" is a registered trademark of Dr. Ing. h.c. F. Porsche AG. All other trademarks are the property of their respective owners. Some European models shown.