



Note: A word about this brochure. Audi of America, Inc., believes the specifications in this brochure to be correct at the time of printing. However, specifications, standard equipment, options, fabrics, and colors are subject to change without notice. Some equipment may be unavailable when your vehicle is built. Please ask your dealer for advice concerning current availability of standard and optional equipment, and your dealer will verify that your vehicle will include the equipment you ordered. Vehicles in this brochure are shown with optional equipment. See your dealer for complete details on the Audi New Vehicle Limited Warranty, twelve-year limited warranty against corrosion perforation, and Audi 24/7 Roadside Assistance. (Roadside assistance coverage provided by Road America in the U.S. Certain conditions apply; see your dealer for details.) Tires supplied by various manufacturers. "Audi," all model names, "Audi connect," "Audi Sport," "Audi ultra," "ASF," "FSI," "MMI," "quattro," "Singleframe" and the Singleframe grille design, "S line," "S tronic®," "TFSI," "Truth in Engineering," and the four rings logo are registered trademarks of AUDI AG. "Alcantara" is a registered trademark of Alcantara S.p.A. "Bang & Olufsen" is a registered trademark of Bang & Olufsen. The BLUETOOTH word mark and logos are owned by the Bluetooth SIG, Inc., and any use of such marks by AUDI AG is under license. "BOSE" and "AudioPilot" are registered trademarks of the BOSE Corporation. "Google," "Google Earth" and "Google Voice" are trademarks of Google Inc. "Homelink" is a registered trademark of Johnson Controls Technology Company. "iPod" is a registered trademark of Apple Inc. "SiriusXM" and all related marks and logos are trademarks of Sirius XM Radio Inc. and its subsidiaries. "TDI" is a registered trademark of Volkswagen AG. "Wi-Fi" is a trademark of the Wi-Fi Alliance. All other trademarks are the property of their respective owners. Some European models shown.

2014 | TT

Audi of America  
Audiusa.com  
Facebook.com/Audi

AoA1414256

© 2013 Audi of America, Inc. Printed in the U.S.A.

# TT

Audi TT Coupe | TT Roadster

Audi  
Truth in Engineering 

It's Audi because

## we're driven by human achievement.

More than just cars, more than just performance. Audi is about the nature of perception, determining how people will respond to and interact with innovative design. It's about applied physics, how things glide through the air and overcome inertia through the application of power, acceleration and exhilaration.<sup>1</sup> It's about artistry, and the way materials elicit a tactile response and provoke an emotional response. It's

chemistry and how it bonds with you. It's poetry written in metal, engineering and design. Audi is the product of learning and application of knowledge. At its best, it is a dynamic example of what humans can create when they are vested in creating something better and bolder. So Audi is not just about cars. But then again, of course, it's also about cars.



<sup>1</sup> Obey all speed and traffic laws.



It's Audi because

## luxury tells the ornate, the garish, the gilded and the over-indulgent...

→ Ornate elements don't help to tell time →

→ Gilt prone to dull →

→ Unnecessary weight means mantle and not wall →



1 Always pay careful attention to the road, and do not drive while distracted. The features and technologies discussed above are optional, may require an additional subscription with separate terms and conditions, and should be used only when it is safe and appropriate. The Wi-Fi® hotspot feature is intended for passenger use only. 2 Features and technologies listed will not be available on all models.

## ...time's up.



← Precise design and improved accuracy ←

← Easily processed information at a glance ←

← Design allows for hanging, for improved viewing angle ←

Excessive luxury is not our goal. But we feel that luxury doesn't mean "more," it means "proper." Proper design, proper fit, proper precision—what Audi thinks of as design purity. Our engineers and designers know that a baroque clock won't tell time any better than a streamlined one, and all the distractions that surround it actually detract from the purpose of the clock itself. Unless, of course, the purpose is just to be noticed, instead of used to its greatest

potential. We think the real purpose of design is simplicity, elegantly rendered. We think you'll see and feel that concept throughout our Audi models. In the clean design lines of the exterior, the streamlined dash, and Audi MMI® interface. In our intuitive available Audi connect®<sup>1</sup>, the seamless fit and finish of our materials and the unmistakable look of our Audi Singleframe® grille.<sup>2</sup> They all work in concert for a pure aesthetic of timeless taste and precision.



It's Audi because

## our reputation hinges on the quality of things you don't see.

It's said that when one door closes, another one opens. It sounds as if whoever said it spent some time at an Audi research and development facility. After all, while you'll open and close the door on your Audi thousands of times without thinking about it, we've obsessed about it for you, in detail. Not just about the reliability of it opening and closing, obviously, but on the proper weight that will make it more pleasing to close. What it should sound like when it is shut. How the locks should click when they are engaged. The optimal acoustic placement for the speaker port. There are the

hinges too, of course. And the door itself, which is designed to take the brunt of side-collision impacts, along with several dozen other considerations that we take into account when designing our doors (to say nothing of the countless other components, processors, sensors, features and the inner workings most people will never see). Our doors are more than a symbol of welcoming you into your vehicle, they are products of Audi engineering, and our reputation hinges on them as much as our hinges help support the door.

### Award-winning design

When Audi engineers set out to build the perfect door, they had one very important goal—lighten the load. By using fully pressed aluminum doors, the weight of the Audi A6 door structure was reduced by an astonishing 44 lb, compared to the previous model. This feat, combined with the strength of its door hinges and ability to retain all of its mechanical, safety and infotainment features, is why it won the Doors and Closures Innovation Award.

### Acoustic enhancements

We spend countless hours listening, so you don't have to. By using soft-mounts on our window regulator, or a sound absorber backing within the door cavity itself, as well as a simple foam liner on our door-release cable, Audi engineers have nearly eliminated all of the ambient noise associated with other less-than-acute manufacturing practices.

### Speaker placement and enclosure

We work with our partners to select optimal placement of our speakers, a vital aspect of our door design, in order to deliver the most engaging and extraordinary sound you can find in the automotive space. Woofers use a specialized lightweight and ported enclosure to ensure optimum low-frequency reproduction.



40% ← Asymmetric torque split<sup>1,2</sup> → 60%

Sport differential<sup>2</sup>

Torque vectoring<sup>2</sup>

You'll find truth in your corner. Torque vectoring is a handling feature so advanced that it seems to respond to your impulses even before you turn the steering wheel. An evolution of cross-axle lock, this system works within the Audi quattro® all-wheel drive system while utilizing Electronic Stability Control (ESC) and the Anti-lock Braking System (ABS) to help sense reduced load or wheel-spin on the inside cornering tire, helping to make turns smoother and more responsive.<sup>2</sup>

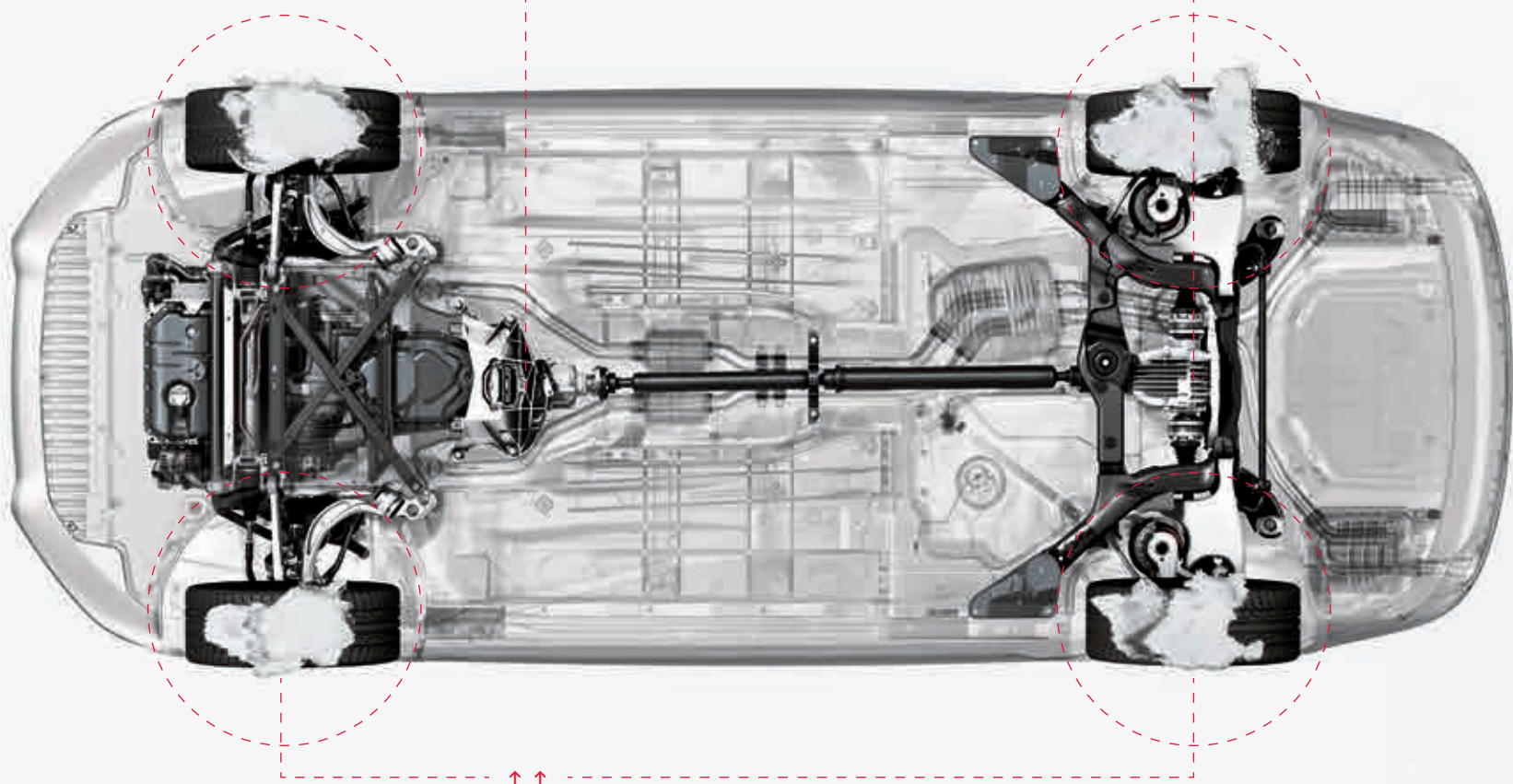

It's Audi because

**conditions don't have to dictate how you stick it to the road.**

As you can see, we've always felt that the best ideas are the ones that stick. And nowhere is that more true than with Audi quattro® all-wheel drive. Since 1980, we've been stuck on articulating an expanding vision of what progressive all-wheel drive technology can deliver. We didn't simply look at it as something to use in poor conditions, but rather as a performance technology that's built to handle roads from the Alps to the autobahn—and points beyond. You've seen quattro® capabilities in the way we dominated the World Rally Championship for years, in the grip you have in inclement weather,

and in the variable rear-wheel-biased power you enjoy in good conditions.<sup>1</sup> For more than 30 years and with five million quattro® systems installed in Audi vehicles, we have continued to refine the technology, developing a rear sport differential to help maximize performance, and torque vectoring to assist with cornering traction while helping to improve handling.<sup>2</sup> We boldly stuck to what worked while the world was trying to catch up, and we built on our vision by adding to a gripping heritage of Audi Sport® performance.

European model shown with optional equipment. 1 Torque split ratio will vary from model to model. 2 Optional features. Features and technologies listed will not be available on all models.



—

Ants can carry up to 50 times their body weight. That got us thinking about lightweight structures, smart engineering and true performance.

It's Audi because

# power is measured by strength, not size.

It's perfectly fine for us to admit that other engines have more cylinders, have more horsepower and have larger displacements. It's just that we've made our engines lighter and more efficient than others, to optimize what we call power density.<sup>1</sup> Because anyone who has driven an Audi knows unmistakable power when they feel it. It means strength that pulses with torque at the moment of acceleration, provides a true, quick response as you change lanes, and turns the most routine cloverleaf into a joyful application of performance

handling. Sure, we love hitting the throttle and feeling the thrust of acceleration;<sup>2</sup> but we also want our drivers to experience the balance and precision of Audi engineering. From the A3 to our track-bred line of Audi performance cars, we are in the business of engineering emotion using more compact engines that concentrate power, while using less weight to your advantage, helping improve handling to the point where others just feel heavy.

---

### TDI®

A turbocharged, fuel-sipping variant, our TDI® clean diesel engine delivers uncompromising Audi performance with bold efficiency.<sup>1</sup> Yes, it gets better mileage per gallon than comparable gasoline engines, but it also produces more low-end torque, which is best expressed in the elasticity you have when passing in the 30- to 60-mph range.

---

### FSI®

The Audi FSI direct injection fuel management and delivery system directly injects fuel into the combustion chambers at precisely managed times and depths. What that means for drivers is that a fully homogenized intake charge helps increase power while also reducing fuel consumption and emissions, making efficiency more powerful.<sup>1</sup>

---

### TFSI®

At Audi, TFSI represents a combination of two of the brand's core areas of expertise—direct injection and forced induction. By adding forced induction (turbocharging or supercharging) to Audi FSI direct injection, the pressurized intake charge is cooled by directly injected fuel, thus achieving efficiency and performance combined with higher compression ratios—previously only attainable by naturally aspirated engines.<sup>1</sup>

---

<sup>1</sup> See [www.fueleconomy.gov](http://www.fueleconomy.gov) for EPA estimates. Your mileage will vary. <sup>2</sup> Obey all speed and traffic laws.





#### Mobile Wi-Fi® hotspot

Provides high-speed connectivity for up to eight passenger devices through an onboard wireless hub.<sup>1,3</sup>



#### City events

Get information about current events, exciting locations and places of interest at your travel destination, current location or other chosen location instantly.<sup>3</sup>



#### myAudi features

Plan travel from your personal computer. Send your desired destinations to your vehicle ahead of time and access your route from your vehicle later.<sup>3</sup>



#### Google Voice™ Local Search

Simply tell your Audi what you are in the mood for, then let the cloud-processing power of Google™ speech recognition interpret your request and bring up a list of destinations in the area of your choice.<sup>3</sup>



#### Google Earth™ with 3D satellite imagery

With Google Earth™ integration, you'll enjoy 3D satellite imagery, including Google Maps Street View, displayed right on the Audi MMI display.<sup>3</sup>

It's Audi because

## spicy chicken is your destiny.

If you are craving an Audi, we know your tastes run a little bold. But what happens when you crave spicy chicken, or a nice vindaloo, or some pepper salsa? Well, in your Audi, you can just say the word, and we'll help find the heat. With available Audi connect®,<sup>1</sup> we've developed a way to seek out your destiny, even if that's just finding the closest gas station, or the best hotel. Audi connect integrates Google™ technol-

gies, like Google Earth™ with 3D satellite imagery, with Audi MMI® Navigation plus.<sup>2</sup> It also provides Wi-Fi® connectivity for up to eight passenger devices to help you stay informed. Check local fuel prices, weather information and, yes, the closest Szechuan restaurant using Google™ Local Search capabilities. Think of where that might take you.<sup>1,3</sup>

1. Always pay careful attention to the road, and do not drive while distracted. The features and technologies discussed above are optional, may require an additional subscription with separate terms and conditions, and should be used only when it is safe and appropriate. The Wi-Fi® hotspot feature is intended for passenger use only. 2. Audi MMI® Navigation plus depends on signals from the worldwide Global Positioning Satellite network. The vehicle's electrical system and existing wireless and satellite technologies must be available and operating properly for the system to function. The system is designed to provide you with suggested routes in locating addresses, destinations and other points of interest. Changes in street names, construction zones, traffic flow, points of interest and other road system changes are beyond the control of Audi of America, Inc. Complete detailed mapping of lanes, roads, streets, toll roads, highways, etc., is not possible, therefore you may encounter discrepancies between the mapping and your actual location. Please rely on your individual judgment in determining whether or not to follow a suggested Audi MMI® Navigation plus route. Periodically mapping updates will be available for purchase at an additional cost. Consult your dealer or call 1-800-FOR-AUDI for details. 3. Optional features. Features and technologies listed will not be available on all models.







#### Elephant skull

How nature solved the apparent conundrum of an elephant's skull didn't escape the notice of Heinrich Timm, the longtime lead engineer for Audi. The weight of the tusks and the general size of an elephant's head would seem to make it impossible for the animal to actually be able to carry it. But the design genius behind the elephant's skull is actually to make it lightweight, yet sturdy. Its predominantly hollow design is buffered by thin, connective bone walls, which act as strong, weight-bearing cells. Audi designers used that idea when building our aluminum and steel structures. Reducing weight, yet enabling strength.

#### Aluminum

Our large aluminum castings are a telling example of Audi ultra® lightweight technology. Primarily used in high-stress areas, these multifunctional castings achieve exceptional rigidity while also allowing for freedom of design, all while remaining extremely lightweight.<sup>1</sup>



It's Audi because

## the elegant structure of nature becomes a blueprint of efficiency.

It seems strange to say that, while we build strong, complex and high-performing machines, we're naturalists at heart. Then again, it might not be that unusual, seeing how nature itself builds strong, complex and high-performing machines as well. When we developed the thinking behind our Audi ultra® lightweight technology initiative, we knew that nature would serve as an inspiration to greater structural efficiency. Take the structure of the elephant skull pictured here. It has to be lightweight, yet capable of carrying a heavy load. It's porous, but its structure is such that it enhances its stability and

strength. We do the same, for example, with aluminum. Positioned one way, aluminum materials can be flexible. Positioned another, they are strong and rigid, and give better support. We also looked to bamboo, which is strong at the conjoined areas (nodes), and flexible along its stem. Our designs allow for both rigidity and flexibility where each is most needed, and for efficiency overall.<sup>2</sup> As we continue to develop strategies to improve the performance aspects and efficiency of our vehicles, we don't shy away from the world around us.<sup>2</sup> We boldly engage it even closer still.

<sup>1</sup> Features and technologies listed will not be available on all models. <sup>2</sup> See [www.fueleconomy.gov](http://www.fueleconomy.gov) for EPA estimates. Your mileage will vary.





It's Audi because

**you I.D. our eye queue.**

Even if you knew nothing about Audi, you'd still know if you were staring at one because we are unafraid to stare back. In fact, that exchange might just be love at first sight. That's how much our iconic LED lighting technology stands out from the pack. So we had the bright idea to make our LED daytime running lights look even more in-

tense. Now featuring a solid, sleek diode design that ingeniously reinvents our signature style, Audi LED lighting technology is once again unmistakably ours. It is an efficient, beautiful way to help you see and be seen during dawn and dusk. Look deeply into our eyes, and you'll know the truth of our attraction.<sup>1</sup>

<sup>1</sup> Features listed are available on all models.





**1 Steering wheel**

The Audi steering wheel is both an ergonomic command center and an elegant structure of performance. Easily accessed controls on the wheel give you control over your MMI® and Audi connect®, while it is designed to give you effortless access to visual information on the driver information display.<sup>1,2</sup>

**2 Audi connect and MMI**

Simple voice or finger motions can help you access information, music and BLUETOOTH® enabled features.<sup>1,2</sup>

**3 Electromechanical parking brake**

Properly positioned in the center console, the parking brake control is another small, but telling, design cue for Audi. The parking brake control serves to enhance the overall ergonomic intent of the vehicle, while delivering easy access and simple functionality.<sup>1</sup>

**4 Bang & Olufsen® Advanced Sound System**

With retractable acoustic lenses and speakers positioned around the Audi specifically to optimize sound quality, Bang & Olufsen® engineers have worked tirelessly with Audi sound designers to create an immersive audio experience.<sup>1</sup>

It's Audi because

## optimized design makes your commute shine a little brighter.

Get away from it all, every day, around 6 p.m., when you leave work and enter into a customized world that's completely dedicated to your comfort and entertainment. This place, of course, is the cabin of your Audi. Optimized luxury, designed by committed craftsmen who have you in mind when they choose the leather seating surfaces, create the adjustable seats or provide the refinement of ergonomic design and a more intuitive MMI. There are small touches that help simplify the overall design, like a

stylish contoured electromechanical parking brake at the foot of the center stack and an available Bang & Olufsen® retracting acoustic lens, perfectly positioned for richly detailed sound quality. And there are large statements, like a steering wheel with easily accessed controls to help you feel comfortably at ease. It is your Audi interior, where you leave the world behind, even when the world might seem in front of you on the way home.<sup>1</sup>

1 Optional features. Features and technologies listed will not be available on all models. 2 Always pay careful attention to the road, and do not drive while distracted. The features and technologies discussed above are optional, may require additional subscription with separate terms and conditions, and should be used only when it is safe and appropriate. The Wi-Fi hotspot feature is intended for passenger use only.



It's Audi because

## it's as if we have SPF for seats.

With innovative pigments and dyes, the Thermocool technology Audi uses in select leather seating surfaces just might prevent that startling moment on hot sunny days. You know the one, when you sit down and feel, immediately, an intense, searing feeling on your leg. Now you can keep your cool. This supple leather doesn't heat up as

much in direct sunlight as traditional leather does. In fact, the difference between untreated leather and the temperature on your seat treated with Thermocool can be as much as 86°. A perfect solution for your Audi A5 Cabriolet, TT Roadster or R8 Spyder, Thermocool technology is Audi to its core. Because it keeps its cool, you can keep yours.



Reduce as much as **86°F**

<sup>1</sup> Images shown are for dramatization purposes only.



# AUDI

## The story of our collection of obsessions.

Precision. Design. Vision. These are the kind of attributes that we deliver as a company, the kind of passions that go way past getting you from point A to point B. That's because Audi knows that how you get to your destination is only part of the story. And so it is with us as a luxury brand. Our obsessions are our commitments, a collection of inspirations that make up our core truth: That from a foundation of brilliant engineering, we craft more than great vehicles—we tell great stories.



TT

## We decided to double down on performance.

Take a closer look at what we mean by iconic sports car. What you'll find is a vehicle that puts as much emphasis on performance as it does on timeless design. It is designed for those who like the thrill of attacking the road in absolute comfort—and progressive style. There's no reason to look back now.

# BECAUSE

T

2014 AUDI TT COUPE SHOWN IN ICE SILVER METALLIC WITH AVAILABLE EQUIPMENT.



## Twins with the same performance gene.

There's more between these two than just stunning good looks. It's a deeper connection, cut from the same legendary racing cloth. Yes, the Audi TT Coupe and Roadster captivate an audience at first sight, but that's just a jumping-off point to a more intense experience. You'll get goose bumps just thinking about how your TT intimately connects you to the pavement as you carve your way up and down a mountain road.<sup>1</sup> And when you consider the attention to detail and luxurious touches found throughout this vehicle, it all becomes even more enticing. Add to all of that a collection of available innovative technologies, and you'll quickly realize that being passionate about performance is one thing, but having it in your DNA is what truly sets you apart.



### *Design*

We do not follow design trends. We set them.

<sup>1</sup> Obey all speed and traffic laws.

2014 AUDI TT ROADSTER SHOWN IN ICE SILVER METALLIC.

T



## Even your mind's eye can't stop staring.

In this case, staring is encouraged. That's what the iconic design of your Audi TT was destined to make happen. And nothing is more electrifying than gazing freely at the TT. Notice how every line comes at you with purpose. The dramatic profile is unmistakable, xenon plus headlights complemented by Le Mans-inspired LED daytime running light technology announce your arrival, and the Audi Singleframe® grille, air inlets and pronounced wheel arches work in concert to highlight the assertive design. Looking away will not be an option.



### *Enlighten*

Shedding a new light on illumination just happened to be a design boon.

Perhaps its most dramatic element, the signature Audi Singleframe® grille makes the TT instantly recognizable. Its lines perfectly meld with the front fascia and combine for a thrilling effect.







**Aluminum trim accents**

Adding to the overall sophistication of the interior are Aluminum-optic trim accents and Brushed Aluminum decorative inlays.



**Driven as much by character as  
by superior control.**

We're just fine with having the interior design that has few peers—or predecessors. As you look around, a unique expression of our design sensibilities for the TT will be apparent, but you'll also see the unmistakable fit and finish that says nothing but "Audi." A driver-oriented cockpit welcomes you as you enter. Luxurious leather/Alcantara® or available Fine Nappa leather seating surfaces offer support in all the right places, Brushed Aluminum inlays give it a subtle, cosmopolitan feel, and a three-spoke flat-bottom multifunction sport steering wheel helps keep you in full command. This is character that isn't afraid of taking control.



**Flat-bottom, aluminum-trimmed steering wheel**

Further expressing its sports car DNA is a steering wheel designed for spirited driving.



**Aluminum-trimmed pedals**

A solid look, and grippy to the touch, aluminum-trimmed pedals call attention to the vehicle's performance roots while adding a little more style for your feet to appreciate.





## A dramatic story, stitched together.

We think we have a compelling story to tell. It starts with a sophisticated interior that offers more than a dollop of sports car panache and luxury. Available high-touch Madras Brown Baseball-optic leather seating surfaces offer superior support and elevate the cabin's distinctiveness. The thick, woven stitching adorning the seat bolsters is visually arresting and pays tribute to an iconic American game. But the details are not limited to just the seating surfaces. An available beautifully wrapped center console and sport steering wheel also boast premium leather treatments, and contrast stitching in the sport steering wheel adds a racetrack-inspired accent.

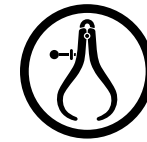

### **Craftsmanship**

We've ensured that every stitch represents the detail that we put into every aspect of an Audi.

### **Baseball-optic leather seating**

As if the interior of the TT doesn't already make a powerful statement, available Baseball-optic leather seating surfaces add a decidedly unique interior treatment that will command attention, even among those oblivious to the sport.



## Open up to total enlightenment.

There's a lot you can learn by just being open. In this case, it's all about SPF to go along with your rpm. Top down, with the sun flooding the cabin, you find the easy charms of the Audi TT Roadster with the touch of a button. Better yet, you don't have to worry about the rpm, either, because the sports car heritage of the TT Roadster delivers them too. You could say it enlightens with joyful abandon.



### Retractable acoustic soft top

Designed with special noise-dampening properties, the TT Roadster offers a top constructed of canvas, lightweight aluminum and steel. It opens and closes with a simple push of a button and can be operated at speeds under 31 mph.

### Adaptive rear spoiler

In order to improve vehicle downforce, the adaptive rear spoiler deploys automatically at 75 mph and retracts at 50 mph.<sup>1</sup>

<sup>1</sup> Obey all speed and traffic laws.





# The case for unbreakable bonds.

Conventional wisdom may suggest that an all-wheel drive system is there purely to provide confidence in inclement weather, but Audi quattro® all-wheel drive is much more than just a foul-weather friend. It's performance engineering that takes on a dry, twisty mountain road as beautifully as it tracks through powder.<sup>1</sup> In other words, quattro® helps enhance performance by appropriately transferring power to the necessary wheels when accelerating and turning, so you have confidence-inspiring performance for almost any road condition. Inclement weather aside, the really gripping story about quattro® is how it performs overall, forging a bond between you and the road that really connects.<sup>1</sup>



▼ 56°F to 78°F



↑

## All-around confidence

Just like life, the road can throw you a curve. So throw one right back with the superior grip and control of quattro®. It helps provide the legendary performance and handling you would expect from Audi, no matter if you're accelerating in the passing lane or carving up a mountain road. This is advanced engineering designed for everyday thrills.<sup>2</sup>



<sup>1</sup> When driving during cold, rainy, snowy or icy weather conditions, ensure that your vehicle is equipped with appropriate all-season or winter tires. Even with appropriate tires, you must always drive in a manner appropriate for the weather, visibility and road conditions. <sup>2</sup> Obey all speed and traffic laws.



▼ HUMIDITY 95%



↑

## Center differential

To help give you optimal traction in practically every situation, the center differential can distribute power to the front and rear wheels individually. During normal driving conditions, it directs 85 percent of the torque to the front wheels, but in extreme circumstances, it can transfer up to 100 percent of the torque to one of the two axles.



↓



▼ WIND 54 mph

# The balance of power has been tipped in your favor.

Just as in nature, the balance of power in your Audi TT is in constant flux. Good thing the engine and transmission find perfect harmony, adding up to an altogether exhilarating experience. The perfectly tuned TFSI® engine helps provide a flawless yin to the advanced Audi S tronic® dual-clutch transmission's yang, achieving a remarkable level of performance, and putting the power right where it should be—under your right foot.

## 2.0 TFSI four-cylinder

This 2.0-liter turbocharged DOHC engine produces 211 horsepower and 258 lb-ft of torque, and combines the valvelift system, Audi FSI® direct injection and turbocharging for great power and overall efficiency.<sup>1</sup>

air out to intercooler  
↑↑↑↑↑↑↑↑

211 horsepower  
258 lb-ft of torque  
Maximum boost pressure 17.4 psi

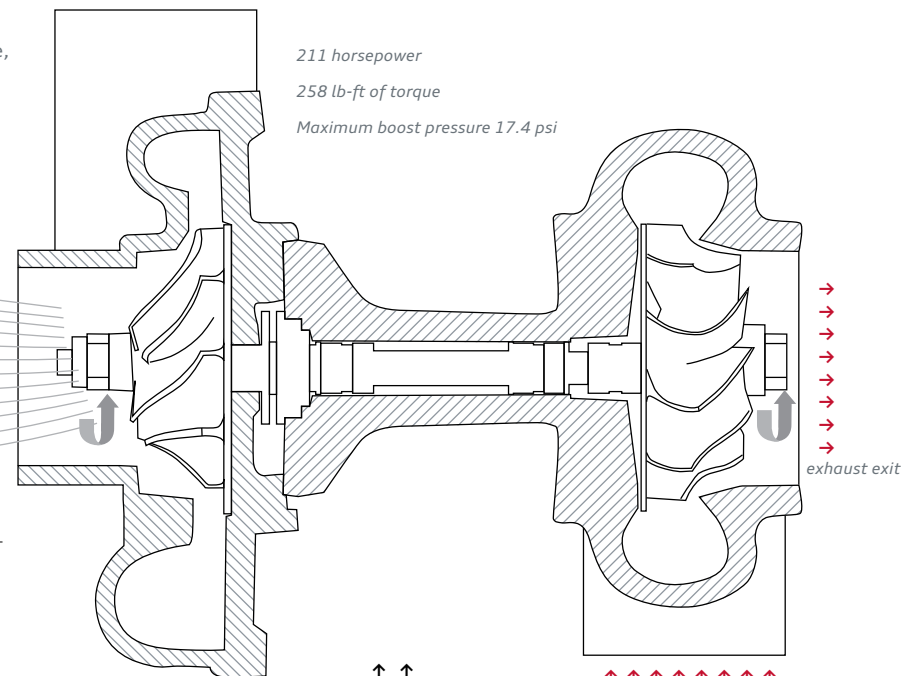

↑ ↑

## Exhaust gas intake

Exhaust from the engine spins the turbine that is connected by a shaft to a compressor that pressurizes air. The compressor forces this pressurized air into the cylinders at boosted pressures up to 17.4 psi, thus producing more power from a smaller displacement engine.

↑↑↑↑↑↑↑↑  
exhaust in

exhaust exit



## Performance

The adage “good things come in small packages” has never been more true.

## Induction-technology turbocharger

Compressing the airflow to the engine allows more air into the cylinder and, ultimately, more power from each combustion cycle, significantly improving the engine's power-to-displacement ratio.

<sup>1</sup> EPA estimates not available at time of printing. See [www.fueleconomy.gov](http://www.fueleconomy.gov) for updated information. Your mileage will vary.  
<sup>2</sup> 0-60-mph times will vary from model to model. <sup>3</sup> Obey all speed and traffic laws.

clutch 02

clutch 01

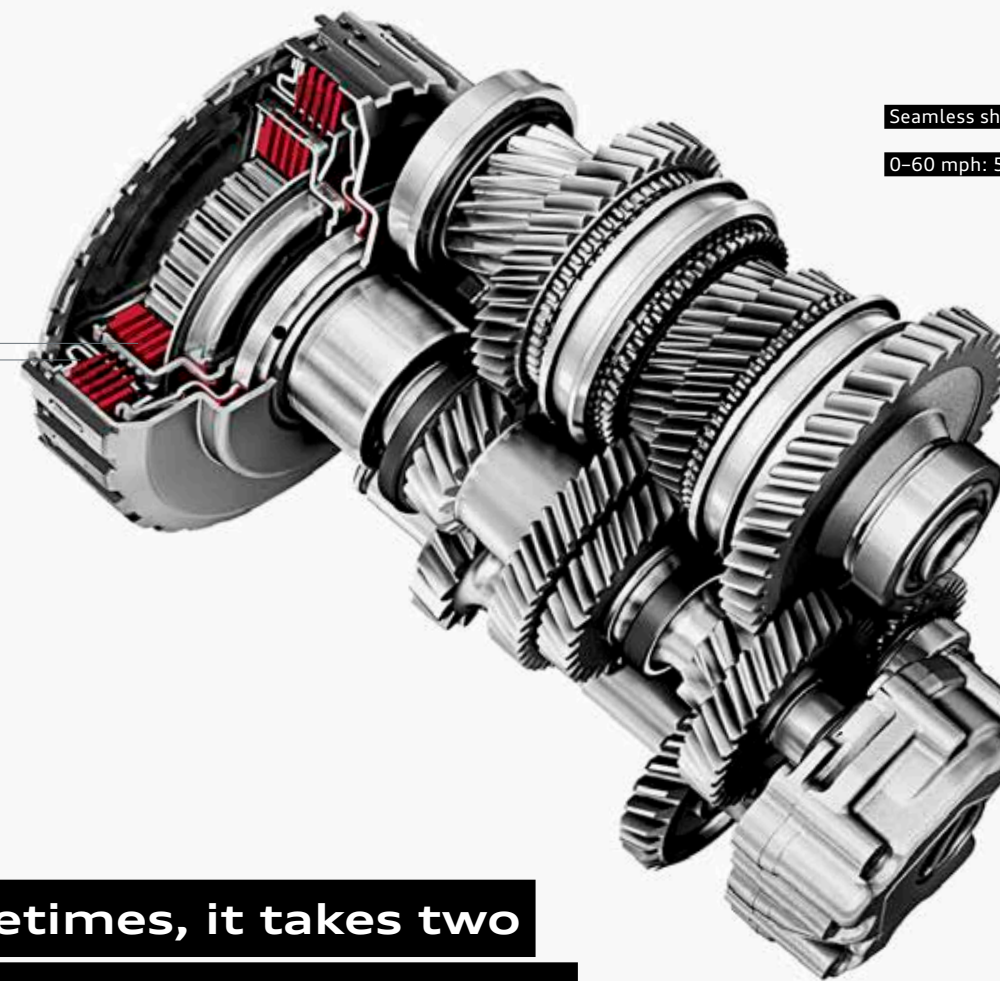

Seamless shifting dual clutch →

0-60 mph: 5.3 seconds<sup>2</sup> →

①

1st gear

① ②

2nd gear

① ②

3rd gear

① ②

4th gear

① ②

5th gear

① ②

6th gear

②

# Sometimes, it takes two to shift in a new direction.

We believe there's power in great teamwork. The concept behind one of the world's most advanced transmissions is simple: provide near-constant power. This is accomplished by having two clutches, two input shafts and two independent gear clusters, giving you the confidence that you'll be in the gear you select the instant you select it. And that translates into big performance numbers.

## Launch control

Get off the line even quicker with the help of Audi launch control. Working in concert with the Audi S tronic dual-clutch transmission, it optimizes launch rev speed and traction so you can expect quicker off-the-line accelerations.<sup>3</sup>



## Dial in to a deeply connected world.

Constant connectivity has become a must in the 21<sup>st</sup> century, so why shouldn't you be able to maintain it in your vehicle? That's why we integrated the available Audi Navigation plus system.<sup>1</sup> It not only helps find the best route to your destination, but also helps you skirt traffic and find a place to eat along the way. And when you need to make a call, you can count on the BLUETOOTH® mobile phone connectivity to make it happen with ease.<sup>2</sup> Of course, you need to be entertained while en route, so we've included SiriusXM® Satellite Radio to get you from coast to coast without skipping a beat.<sup>1</sup>



### BOSE® sound system

Hitting the right note on every drive, the BOSE® sound system turns your TT into a twelve-speaker powerhouse, while AudioPilot® noise compensation helps maintain a consistent volume under varying speeds and road conditions. It all adds up to an acoustic listening environment that rivals any live performance.

<sup>1</sup> See Infotainment/Technology section of the Featured Content page for important information regarding Audi Navigation plus and required SiriusXM® subscriptions. <sup>2</sup> Requires compatible phone.



### Audi Navigation plus

The intuitive Audi Navigation plus is available to help ensure that you'll be able to quickly input your next destination. And with the Audi traffic information feature, you can bet you'll get there without the gridlock.<sup>1</sup>

### BLUETOOTH® technology

Staying connected has never been more important. That's why your TT features BLUETOOTH® mobile phone connectivity for simple, hands-free functionality. With a simple push of a button on the steering wheel, you can make and receive calls.<sup>2</sup>

### SiriusXM® Satellite Radio

Go ahead. Crisscross the country. We assure you, you'll never run out of entertainment options, with over 130 channels of music, talk and news.<sup>1</sup>

### Audi media

Now you're in control. The available Audi music interface helps give you seamless iPod® integration. Your iPod® can be controlled through the audio system and steering controls, and with two available SD card slots for your MP3 music, your entertainment options just keep getting better.

# We don't see safety as an option, or a luxury.

Audi engineers don't equate strength with size. Big is just big—strong is a more flexible concept. While you may not think about weight savings when it comes to strength, we'd like you to take a second and think again. ASF® aluminum construction developed by Audi engineers is a revolutionary technology that offers an innovative approach to both weight savings and strength. And Audi airbag technology is designed to deploy airbags based on seat position,<sup>1</sup> while specially constructed crumple zones give way upon impact to help mitigate potential injury in a collision. All of this, combined with the rigidity of laser seam-welded joints that enhance the strength of every Audi we make, helps diminish the impact of an unavoidable event.

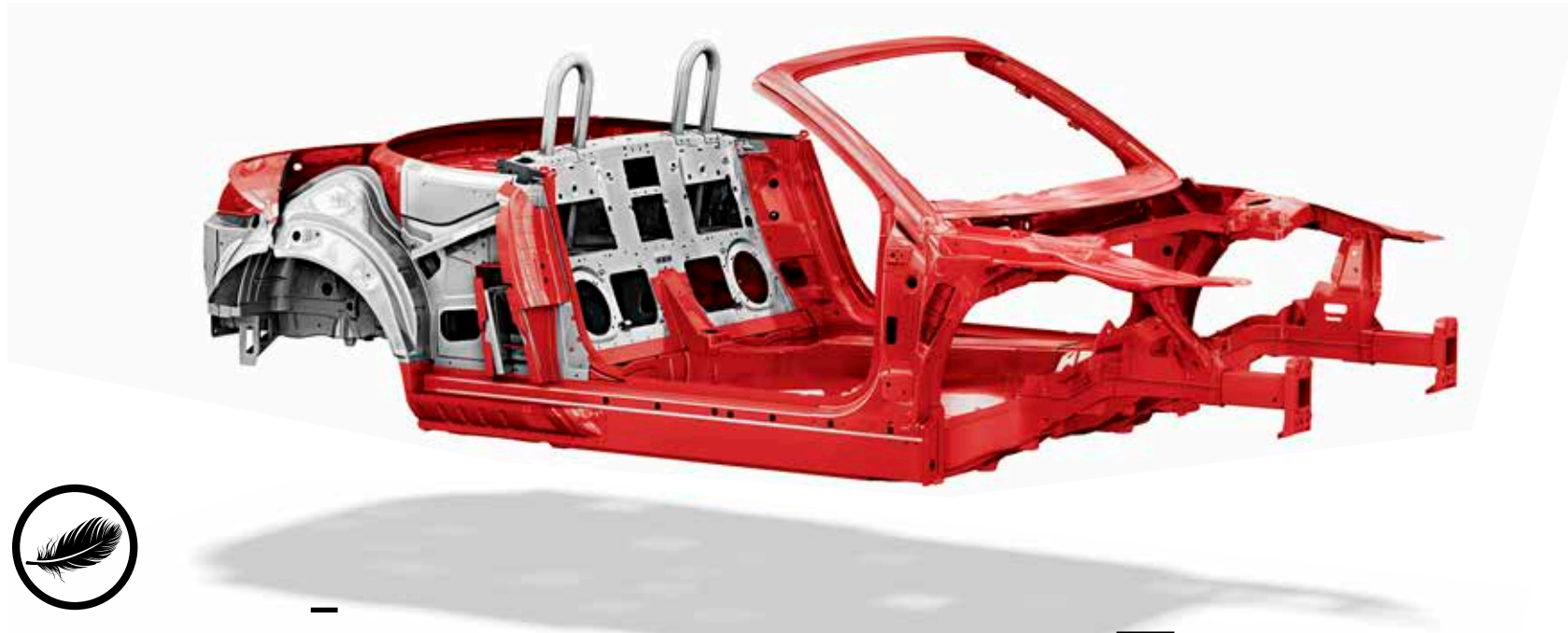

## Audi ultra®

Heavy thinking on lightweight technology.

Revolutionary **Audi ultra® lightweight technology** offers an innovative approach to weight savings—a benefit you will notice in the overall efficiency,<sup>2</sup> enhanced performance and remarkable handling of the Audi TT. These unique characteristics also help to absorb the normal bumps of the road, delivering a smoother ride.

## Rollover protection system

Built into the TT Roadster are heavily reinforced rollover protection devices, designed to help protect you and your passenger in the unlikely event of a rollover. In addition to helping provide another level of safety, they also add to the overall visual muscle of the Roadster.



## Crumple zones

*Knautschzone* may be an ugly word, but it's a beautiful technology. German for "crumple zone," this ingenious safety feature helps dissipate the energy from a collision by spreading the impact forces around the passenger cell and away from its occupants. In doing so, it also slows the vehicle's deceleration rate, which helps to further lessen the force of impact.



## Sheet steel

A sheet-steel rear body structure combined with aluminum castings, extruded sections and aluminum sheet metal makes up the body shell of the Audi TT.

## ESC and ABS

Computerized technology that works in perfect sync with the Anti-lock Brake System (ABS), Electronic Stability Control (ESC) helps minimize any loss of stability, applying brake pressure to individual wheels and reducing throttle input to help counter oversteer or understeer when the vehicle needs it.

## Six standard airbags

Helping protect you from almost all angles are six standard airbags, front-impact airbags for driver and passenger, driver and front-passenger knee airbags, and seat-mounted, side-impact head and thorax airbags.<sup>1</sup>

<sup>1</sup> Airbags are supplemental restraints only and will not deploy in all crash circumstances. Always use safety belts and refer to your owner's manual for the proper use of the restraint systems when transporting children. <sup>2</sup> EPA estimates not available at time of printing. See [www.fueleconomy.gov](http://www.fueleconomy.gov) for updated information. Your mileage will vary.





# TTS

ENGINE // 2.0-liter turbocharged TFSI® four-cylinder engine developing 265 hp and 258 lb-ft of torque

DRIVETRAIN // Audi quattro® all-wheel drive, six-speed Audi S tronic® dual-clutch transmission

CHASSIS // TTS tuned sport suspension, Audi magnetic ride

BRAKES // 13.4" ventilated front disc brakes with TTS logo, 12.2" ventilated rear disc brakes

PERFORMANCE // Top track speed of 155 mph;<sup>1</sup> acceleration 0–60 mph in 4.9 seconds (Coupe) and 5.1 seconds (Roadster)

## Brag without saying a word.

We aren't the type to encourage bragging, but in this case we concede that it's inevitable. So make it count, with a potent 265-horsepower 2.0-liter TFSI engine, S quad exhaust outlets, and the strong stance and dramatic curves that showcase a performance profile that backs down to no one. Add a bold S model Audi Singleframe® grille with Aluminum-optic double-blade crossbars for distinction and a rapid-fire Audi S tronic® dual-clutch transmission featuring launch control to define its muscularity. Your final point will be made when you make the run from 0 to 60 mph in a blistering 4.9 seconds<sup>2</sup>—just in case anyone still had any doubts.



### Audi exclusive bicolor interior

A car this brash deserves an equally provocative cockpit. The available Audi exclusive bicolor interior gives you just that, with contrasting Black/Crimson Red or Black/Titanium Gray leather lining the seats, door panels, center console and floor mats. It also includes contrasting stitching on the shifter and instrument cover.

### Audi Sport

The story doesn't stop here. There's more on the full range of S, RS, and R8 Audi performance models in the **2014 Audi Sport brochure**. See your dealer or go to [audiusa.com](http://audiusa.com) for details.

<sup>1</sup> Top track speed is electronically limited in the U.S. Obey all speed and traffic laws. <sup>2</sup> 0–60-mph times will differ from model to model.

## Exterior Colors

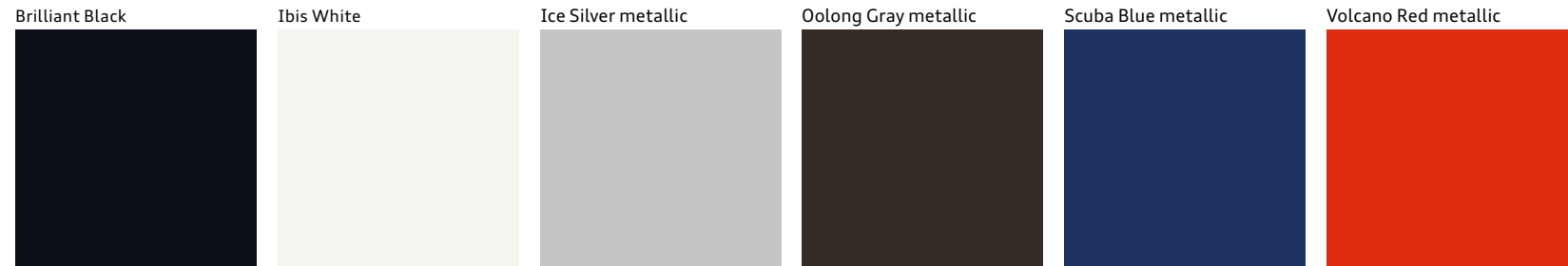

Audi S line® Competition package

Audi S line® Competition package

Audi S line® Competition package

## Interior Colors

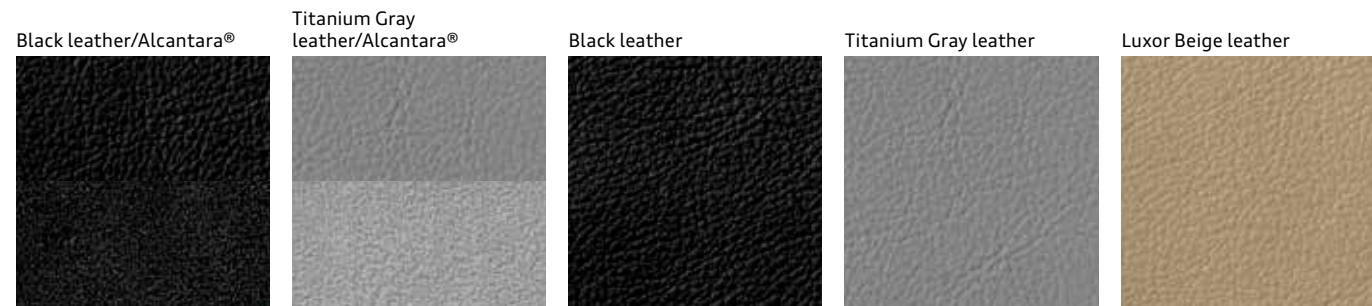

Audi S line® package

Audi S line® Competition package



## Decorative Inlays

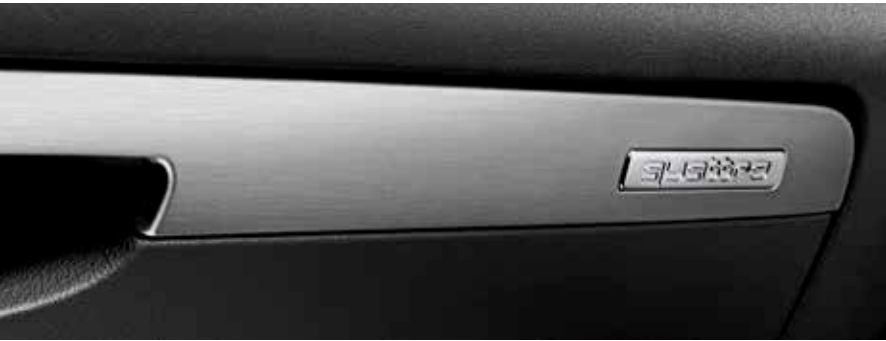

Brushed Aluminum



Matte Brushed Aluminum



Samoa Orange<sup>1</sup>



Audi S line® package  
Audi S line® Competition package

Audi S line® Competition package

<sup>1</sup> Decorative inlay options will vary based on model and exterior color combination. See your dealer for details.

## Wheels

18" 10-spoke design  
245/40 summer performance tires<sup>2</sup>



18" 5-arm-dynamic design  
245/40 all-season self-supporting run-flat tires



(optional)

19" 7-twin-spoke design  
255/35 summer performance tires<sup>2</sup>



Audi S line® package

19" 5-arm-rotor design (Matte Black finish)  
255/35 summer performance tires<sup>2</sup>



Audi S line® Competition package

<sup>2</sup> Tires are supplied and warranted by their manufacturer. High-performance tires are designed for optimum performance and handling in warm climates. They are not suitable for cold, snowy or icy weather conditions. If you drive under those circumstances, you should equip your vehicle with all-season or winter tires, which offer better traction under those conditions. We suggest you use the recommended winter or all-season tire specified for your car or its equivalent. These high-performance tires also have a lower aspect ratio that aids performance and handling; however, in order to avoid tire, rim or vehicle damage, it is important that the inflation pressure is regularly checked and maintained at optimum levels. Please also remember in making your selection that, while these tires deliver responsive handling, they may ride less comfortably and make more noise than other choices. Finally, these tires may wear more quickly than other choices.

## Technical Specifications

### Engineering | Performance

	TT Coupe	TT Roadster
Engine type	Four-cylinder	Four-cylinder
Engine block/Cylinder head	Cast-iron/Aluminum-alloy	Cast-iron/Aluminum-alloy
Displacement (cc)/Bore and stroke (mm)	1,984/82.5 x 92.8	1,984/82.5 x 92.8
Horsepower (@ rpm)	211 @ 4,300	211 @ 4,300
Torque (lb-ft @ rpm)	258 @ 1,600	258 @ 1,600
Compression ratio	9.6:1	9.6:1
Valvetrain	16-valve DOHC	16-valve DOHC
Induction/Fuel injection	Turbocharged/TFSI®	Turbocharged/TFSI®
Acceleration (0–60 mph)	5.3 seconds	5.6 seconds
Top track speed <sup>1</sup>	130 mph	130 mph

### Transmission | Drivetrain

Six-speed Audi S tronic® dual-clutch transmission with Audi quattro® all-wheel drive (Gear ratios: 1st: 2.923, 2nd: 1.792, 3rd: 1.185, 4th: 0.829, 5th: 0.862, 6th: 0.686, Reverse: 3.264, Final drive: 1st–4th, 4.769, 5th–6th, 3.444)	■	■
--	---	---

### Body | Suspension | Chassis

Audi ultra® lightweight technology—ASF® aluminum construction	■	■
MacPherson strut front suspension	■	■
Four-link rear suspension	■	■
Sport suspension calibration	■	■
Audi S line® sport suspension calibration	Available	Available
Ventilated front disc/Solid rear disc brakes (in)	12.3/11.3	12.3/11.3
Electromechanical power steering system	■	■
Steering ratio	16.9:1	16.9:1
Turning diameter, curb-to-curb (ft)	35.96	35.96

### Exterior measurements

	TT Coupe	TT Roadster
Wheelbase (in)	97.2	97.2
Length (in)	165.3	165.3
Height (in)	53.2	53.5
Overall width with mirrors (in)	NA	NA
Overall width without mirrors (in)	72.5	72.5
Track front/rear (in)	61.5/60.9	61.5/60.9
Curb weight (lb)	3,175	3,340
Drag coefficient (C <sub>w</sub> )	0.30	0.32

### Interior measurements

Head room (in, front/rear)	37.7/32.6	37.6/—
Leg room (in, front/rear)	41.1/29.3	41.1/—
Shoulder room (in, front/rear)	53.2/47.5	53.2/—
Cargo volume (cu ft, rear seatbacks up/folded)	13.1/24.7	—
Cargo volume (cu ft)	—	8.8
Seating capacity	2 + 2	2

### EPA mileage estimates | Capacities

Audi S tronic® dual-clutch transmission (city/highway/combined) <sup>2</sup>	NA	NA
Engine oil (qt)	4.9	4.9
Coolant system (qt)	9.1	9.1
Fuel (gal)	15.8	15.8
Recommended fuel	Premium	Premium
Emissions rating	ULEV II	ULEV II

■ Standard    — Not applicable    NA Information not available at time of printing



Technical specifications and featured content for Audi TTS models can be found in the [2014 Audi Sport brochure](#). See your dealer or go to [audiusa.com](http://audiusa.com) for details.

<sup>1</sup> Top track speed is electronically limited in the U.S. Obey all speed and traffic laws. <sup>2</sup> EPA estimates not available at time of printing. See [www.fueleconomy.gov](http://www.fueleconomy.gov) for updated information. Your mileage will vary.



## Featured Content

Safety   Security	TT Coupe	TT Roadster
Driver and front passenger dual-stage airbags, front head/thorax side airbags and knee airbags <sup>1</sup>	■	■
Front passenger occupant detection for airbags <sup>1</sup>	■	■
Safety belt reminder for driver and front passenger	■	■
Lower Anchors and Tethers for CHildren (LATCH) in rear seats	■	—
Power central locking system with safety unlock feature if airbags deploy	■	■
Electronic Stability Control (ESC) with traction control (ASR)	■	■
Anti-lock Brake System (ABS) with Electronic Brake-pressure Distribution (EBD) and brake assist	■	■
Hill hold assist	■	■
Tire-pressure monitoring system	■	■
Anti-theft alarm system with immobilizer	■	■

Exterior	TT Coupe	TT Roadster
Audi Singleframe® grille	■	■
Gloss Black Audi Singleframe® grille	Available	Available
Xenon plus headlights with LED daytime running light technology	■	■
Headlight washing system	■	■
Automatic headlights	■	■
Front fog lights	■	■
Taillights with dark red lenses	■	■
Power-adjustable, heated exterior side mirrors	■	■
Black trim around exterior windows	■	—
LED turn indicator light technology integrated into the exterior side mirrors	■	■
Heated windshield washer nozzles	■	■
Adaptive rear spoiler	■	■
Fixed rear spoiler	Available	Available
Dual exhaust outlets	■	■
Audi S line® exterior appearance	■	■
Audi S line® Competition package exterior appearance (Gloss Black front lower spoiler splitter, exterior side mirror housings, fixed rear spoiler; Black diffuser and exhaust finishers)	Available	Available

■ Standard — Not applicable

Interior	TT Coupe	TT Roadster
Automatic climate control	■	■
Three-spoke flat-bottom multifunction sport steering wheel with shift paddles	■	■
Tilt and telescopic manually adjustable steering column	■	■
Auto-dimming interior rear view mirror with digital compass	■	■
Illuminated locking glove box	■	■
Aluminum shift knob	■	■
Two beverage holders	■	■
Decorative interior inlays (see Decorative Inlays page for more detail)	■	■
Front and rear floor mats (Roadster: front only)	■	■
Ambient LED interior lighting technology	■	■
Black cloth headliner	■	■
Dual front sun visors with lighted vanity mirrors	■	■
Power windows with pinch protection	■	■
Power operated wind deflector	—	■
Acoustic folding roof—folds at speeds up to 31 mph	—	■

Seating	TT Coupe	TT Roadster
Leather/Alcantara® seating surfaces (see Interior Colors page for more detail)	■	■
Fine Nappa Leather seating surfaces (see Interior Colors page for more detail)	Available	Available
Baseball-optic Fine Nappa Leather seating surfaces (see Interior Colors page for more detail)	Available	Available
Twelve-way power front sport seats, including four-way power lumbar adjustment	■	■
Heated front seats	Available	Available
Storage drawer under front passenger's seat	■	■
Storage net in front passenger's footwell and front seatbacks	■	■
2+2 seating arrangement	■	—
Split folding 50/50 rear seatbacks	■	—
Load-through facility with ski bag	—	■

<sup>1</sup> Airbags are supplemental restraints only and will not deploy in all crash circumstances. Always use safety belts and refer to your owner's manual for the proper use of the restraint systems when transporting children.

## Featured Content

### Infotainment | Technology

	TT Coupe	TT Roadster
Audi Navigation plus <sup>1</sup>	Available	Available
Backlit instrument cluster with automatic brightness control	■	■
Driver information system with lap timer	■	■
BOSE® sound system with twelve speakers and AudioPilot® noise compensation	■	■
Single CD player with MP3 playback capability	■	■
SiriusXM® Satellite Radio with 90-day trial subscription <sup>2</sup>	■	■
Traffic information	Available	Available
SD card slots (dual slots)	Available	Available
Audi music interface with iPod® integration	Available	Available
BLUETOOTH® wireless technology preparation for mobile phone <sup>3</sup>	■	■
Garage door opener (HomeLink®)	■	■
Cruise control with coast, resume and accelerate features	■	■
Parking system with rear sensors	Available	Available
Rain/light sensor for automatic windshield wipers and headlights	■	■

■ Standard    — Not applicable

<sup>1</sup> Audi Navigation plus depends on signals from the worldwide Global Positioning Satellite network. The vehicle's electrical system and existing wireless and satellite technologies must be available and operating properly for the system to function. The system is designed to provide you with suggested routes in locating addresses, destinations and other points of interest. Changes in street names, construction zones, traffic flow, points of interest and other road system changes are beyond the control of Audi of America, Inc. Complete detailed mapping of lanes, roads, streets, toll roads, highways, etc., is not possible, therefore you may encounter discrepancies between the mapping and your actual location. Please rely on your individual judgment in determining whether or not to follow a suggested Audi Navigation plus route. For mapping updates please see your Audi dealer or call 1-800-FOR-AUDI for details. <sup>2</sup> SiriusXM® Satellite Radio subscriptions sold separately after trial expires. Subscriptions are governed by SiriusXM® Customer Agreement (see www.siriusxm.com) and are continuous until you call SiriusXM® to cancel. SiriusXM® U.S. Satellite Service available only to those 18 and older in the 48 contiguous U.S.A., D.C. and Puerto Rico (with coverage limitations). <sup>3</sup> Requires compatible phone.

## There's a way to make an entrance without trying.

Not that the Audi TT isn't already dressed to kill, but when you opt for the Audi S line® Competition package, you make a bold statement even bolder. The S line exterior features striking Black-optic elements, including a grille surround, side mirror housings, a fixed rear wing spoiler and a lower front spoiler splitter. Setting it apart even further are a Black diffuser, Black exhaust tips, and 19" 5-arm-rotor design wheels in Matte Black finish. Plenty to ensure that your arrival will be unmistakably Audi.





## Accessories

Add a new point of view, a dash of distinction and the ultimate in self-expression with Audi Genuine Accessories. Whether you load the cargo carrier with climbing gear or add a set of sporty new wheels, we've got the accessories that will help enhance every facet of your lifestyle. Designed for seamless compatibility with your Audi,

all pieces are backed by your vehicle's 4-year/50,000-mile limited warranty or the accessory's 12-month/12,000-mile limited warranty, whichever extends longer from the accessory purchase date! If you're looking to personalize or protect, Audi offers an intelligent solution.



### Fork-mount bike rack

Made of anodized aluminum, this rack features a quick-clamping device that can be secured with the included lock.<sup>2,3</sup>



### Ski and snowboard rack

Push-button, keyed locks open and close easily. Rubber-cushioned aluminum bars hold securely. Standard attachment (shown) holds two sets of skis or two snowboards. Deluxe attachment holds up to three sets of skis or four snowboards.<sup>2,3</sup>

### Valve stem caps

Emblazoned with the iconic Audi rings, these handsome caps complement the unique design of the wheels on your Audi.



### All-weather cargo mat

Custom fit for the TT. Textured material helps control load shifting. Raised lip helps contain spills and protect cargo-area carpeting from stains. (Coupe only.)



### 19" 5-arm turbo-design wheels

Add a "twist" to turn heads at every turn. Audi Genuine Alloy Wheels are designed with style and longevity in mind. Shown in Black. Also available in Silver or White.

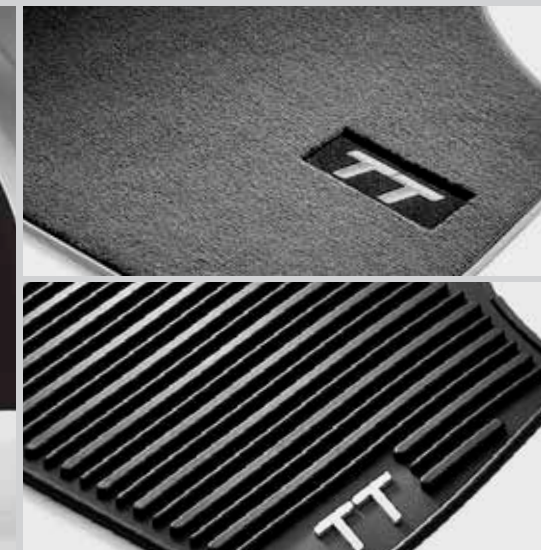

### Premium textile floor mats

These skid-resistant, precision-fit mats are made of long-life fabric to help protect the vehicle's interior from the elements. Mats are black with silver piping and available in a set of two.

### All-weather floor mats

Deep-ribbed, channeled design helps protect the floor and carpeting from water, mud, sand and snow. Black mats feature the vehicle logo and are available in a set of two.



### Rear wing

Add sporty flair to the TT or TTS. Primed for painting, or available pre-painted for a perfect color match and added convenience. Consult your authorized Audi dealer for available colors.

Other accessories not shown →

### Audi Genuine Sport and Design Accessories

Your Audi vehicle features a bold, aggressive stance with strong, stunning lines. Enhance it by adding Audi Genuine Sport and Design Accessories. All are carefully scrutinized in the design and development process. So while they're striking in appearance, they've also passed rigorous quality assessments, including corrosion testing. If you're looking for a bolder appearance or a finishing touch, there is a solution designed by Audi that makes every mile more enjoyable—and more yours.

### Audi Genuine Alloy Wheels

Strike the perfect balance between breathtaking design and awe-inspiring performance with Audi Genuine Alloy Wheels. Audi experts have meticulously designed these wheels especially for each Audi model. They're engineered to the highest standards and endure rigorous testing to help ensure long-term quality. Experience eye-catching style that is yours and yours alone. Nothing enhances the bold, dynamic look of your Audi vehicle faster.

### Audi TravelSpace Transport Accessories

You go almost everywhere. Give your Audi the proper invitation to be part of your adventures. Never leave the necessary gear behind. Bring it with Audi TravelSpace Transport Accessories. The list includes bike racks, ski racks, a variety of watersports equipment carriers and various sizes of cargo carriers. Wherever you go, make sure almost everything fits with a variety of intelligent and innovative solutions. Accessories designed for your life—the passionate, active part.

### Audi Genuine Electronics Accessories

The illuminating technology that graces each Audi vehicle provides the inspiration for Audi Genuine Electronics Accessories. Similarly, all of these accessories are impressively advanced and inspiring. Our audio options let you enhance your listening pleasure. Other accessory options help promote more convenient travel. All are designed and tested to ensure compatibility with the vehicle's electrical systems, allowing you to enjoy every aspect of Audi technology with almost all your senses. Demand the best and drive with added confidence.

### Audi Guard Comfort and Protection Accessories

Help protect what you love. Audi Guard Comfort and Protection Accessories offer functional, practical items that help keep your Audi in pristine condition. Choose from such useful items as trunk liners that help make clean-up quick and easy, or an easy-to-use storage cover that helps shield the vehicle. Use them all to help reduce wear and tear and keep the vehicle looking like new—inside and out. All are engineered to stringent Audi standards, so you can be assured of their quality and durability.

<sup>1</sup> See dealer for details. <sup>2</sup> All roof-rack system attachments require the base carrier bars. All attachments sold separately. <sup>3</sup> Recreational equipment and sporting equipment not included.