



2014 | Q5

Audi of America
Audiusa.com
Facebook.com/Audi

AoA1414209

Note: A word about this brochure. Audi of America, Inc., believes the specifications in this brochure to be correct at the time of printing. However, specifications, standard equipment, options, fabrics, and colors are subject to change without notice. Some equipment may be unavailable when your vehicle is built. Please ask your dealer for advice concerning current availability of standard and optional equipment, and your dealer will verify that your vehicle will include the equipment you ordered. Vehicles in this brochure are shown with optional equipment. See your dealer for complete details on the Audi New Vehicle Limited Warranty, twelve-year limited warranty against corrosion perforation, and Audi 24/7 Roadside Assistance. (Roadside assistance coverage provided by Road America in the U.S. Certain conditions apply; see your dealer for details.) Tires supplied by various manufacturers. "Audi," all model names, "Audi connect," "Audi Sport," "Audi ultra," "FSI," "MMI," "quattro," "S line," "Sideguard," "Singleframe" and the Singleframe grille design, "TFSI," "Truth in Engineering," and the four rings logo are registered trademarks of AUDI AG. "AdBlue" is a registered trademark of the Verband der Automobilindustrie. "Bang & Olufsen" is a registered trademark of Bang & Olufsen. The BLUETOOTH word mark and logos are owned by the Bluetooth SIG, Inc., and any use of such marks by AUDI AG is under license. "Google," "Google Earth" and "Google Voice" are trademarks of Google Inc. "HD Radio" and the HD Radio logo are proprietary trademarks of iBiquity Digital Corporation. "HomeLink" is a registered trademark of Johnson Controls Technology Company. "iPod" is a registered trademark of Apple Inc. "SiriusXM" and all related marks and logos are trademarks of Sirius XM Radio Inc. and its subsidiaries. "TDI" is a registered trademark of Volkswagen AG. "Tiptronic" is a registered trademark of Dr. Ing. h.c. F. Porsche AG. "Wi-Fi" is a trademark of the Wi-Fi Alliance. All other trademarks are the property of their respective owners. Some European models shown.

© 2013 Audi of America, Inc. Printed in the U.S.A.

Q5

Audi Q5 | Q5 hybrid

Truth in Engineering **Audi** 

It's Audi because

we're driven by human achievement.

More than just cars, more than just performance. Audi is about the nature of perception, determining how people will respond to and interact with innovative design. It's about applied physics, how things glide through the air and overcome inertia through the application of power, acceleration and exhilaration.¹ It's about artistry, and the way materials elicit a tactile response and provoke an emotional response. It's

chemistry and how it bonds with you. It's poetry written in metal, engineering and design. Audi is the product of learning and application of knowledge. At its best, it is a dynamic example of what humans can create when they are vested in creating something better and bolder. So Audi is not just about cars. But then again, of course, it's also about cars.



¹ Obey all speed and traffic laws.

It's Audi because

luxury tells the ornate, the garish, the gilded and the over-indulgent...

→ Ornate elements don't help to tell time →

→ Gilt prone to dull →

→ Unnecessary weight means mantle and not wall →



1 Always pay careful attention to the road, and do not drive while distracted. The features and technologies discussed above are optional, may require an additional subscription with separate terms and conditions, and should be used only when it is safe and appropriate. The Wi-Fi® hotspot feature is intended for passenger use only. 2 Features and technologies listed will not be available on all models.

...time's up.



← Precise design and improved accuracy ←

← Easily processed information at a glance ←

← Design allows for hanging, for improved viewing angle ←

Excessive luxury is not our goal. But we feel that luxury doesn't mean "more," it means "proper." Proper design, proper fit, proper precision—what Audi thinks of as design purity. Our engineers and designers know that a baroque clock won't tell time any better than a streamlined one, and all the distractions that surround it actually detract from the purpose of the clock itself. Unless, of course, the purpose is just to be noticed, instead of used to its greatest

potential. We think the real purpose of design is simplicity, elegantly rendered. We think you'll see and feel that concept throughout our Audi models. In the clean design lines of the exterior, the streamlined dash, and Audi MMI® interface. In our intuitive available Audi connect®¹, the seamless fit and finish of our materials and the unmistakable look of our Audi Singleframe® grille.² They all work in concert for a pure aesthetic of timeless taste and precision.

It's Audi because

our reputation hinges on the quality of things you don't see.

It's said that when one door closes, another one opens. It sounds as if whoever said it spent some time at an Audi research and development facility. After all, while you'll open and close the door on your Audi thousands of times without thinking about it, we've obsessed about it for you, in detail. Not just about the reliability of it opening and closing, obviously, but on the proper weight that will make it more pleasing to close. What it should sound like when it is shut. How the locks should click when they are engaged. The optimal acoustic placement for the speaker port. There are the

hinges too, of course. And the door itself, which is designed to take the brunt of side-collision impacts, along with several dozen other considerations that we take into account when designing our doors (to say nothing of the countless other components, processors, sensors, features and the inner workings most people will never see). Our doors are more than a symbol of welcoming you into your vehicle, they are products of Audi engineering, and our reputation hinges on them as much as our hinges help support the door.

Award-winning design

When Audi engineers set out to build the perfect door, they had one very important goal—lighten the load. By using fully pressed aluminum doors, the weight of the Audi A6 door structure was reduced by an astonishing 44 lb, compared to the previous model. This feat, combined with the strength of its door hinges and ability to retain all of its mechanical, safety and infotainment features, is why it won the Doors and Closures Innovation Award.

Acoustic enhancements

We spend countless hours listening, so you don't have to. By using soft-mounts on our window regulator, or a sound absorber backing within the door cavity itself, as well as a simple foam liner on our door-release cable, Audi engineers have nearly eliminated all of the ambient noise associated with other less-than-acute manufacturing practices.

Speaker placement and enclosure

We work with our partners to select optimal placement of our speakers, a vital aspect of our door design, in order to deliver the most engaging and extraordinary sound you can find in the automotive space. Woofers use a specialized lightweight and ported enclosure to ensure optimum low-frequency reproduction.

40% ← Asymmetric torque split^{1,2} → 60%

Sport differential²

Torque vectoring²

You'll find truth in your corner. Torque vectoring is a handling feature so advanced that it seems to respond to your impulses even before you turn the steering wheel. An evolution of cross-axle lock, this system works within the Audi quattro® all-wheel drive system while utilizing Electronic Stability Control (ESC) and the Anti-lock Braking System (ABS) to help sense reduced load or wheel-spin on the inside cornering tire, helping to make turns smoother and more responsive.²

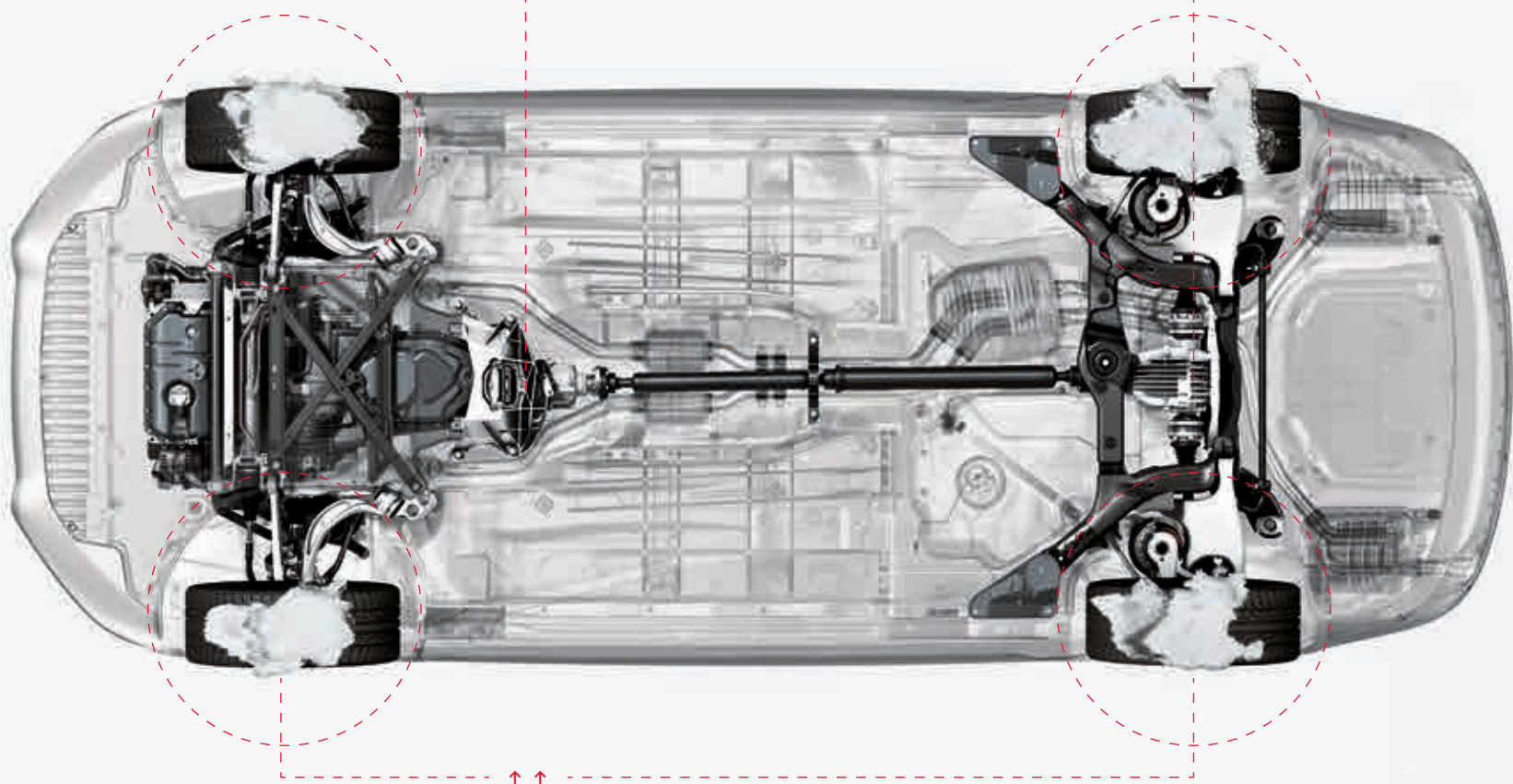

It's Audi because

conditions don't have to dictate how you stick it to the road.

As you can see, we've always felt that the best ideas are the ones that stick. And nowhere is that more true than with Audi quattro® all-wheel drive. Since 1980, we've been stuck on articulating an expanding vision of what progressive all-wheel drive technology can deliver. We didn't simply look at it as something to use in poor conditions, but rather as a performance technology that's built to handle roads from the Alps to the autobahn—and points beyond. You've seen quattro® capabilities in the way we dominated the World Rally Championship for years, in the grip you have in inclement weather,

and in the variable rear-wheel-biased power you enjoy in good conditions.¹ For more than 30 years and with five million quattro® systems installed in Audi vehicles, we have continued to refine the technology, developing a rear sport differential to help maximize performance, and torque vectoring to assist with cornering traction while helping to improve handling.² We boldly stuck to what worked while the world was trying to catch up, and we built on our vision by adding to a gripping heritage of Audi Sport® performance.

European model shown with optional equipment. 1 Torque split ratio will vary from model to model. 2 Optional features. Features and technologies listed will not be available on all models.



—

Ants can carry up to 50 times their body weight. That got us thinking about lightweight structures, smart engineering and true performance.

It's Audi because

power is measured by strength, not size.

It's perfectly fine for us to admit that other engines have more cylinders, have more horsepower and have larger displacements. It's just that we've made our engines lighter and more efficient than others, to optimize what we call power density.¹ Because anyone who has driven an Audi knows unmistakable power when they feel it. It means strength that pulses with torque at the moment of acceleration, provides a true, quick response as you change lanes, and turns the most routine cloverleaf into a joyful application of performance

handling. Sure, we love hitting the throttle and feeling the thrust of acceleration;² but we also want our drivers to experience the balance and precision of Audi engineering. From the A3 to our track-bred line of Audi performance cars, we are in the business of engineering emotion using more compact engines that concentrate power, while using less weight to your advantage, helping improve handling to the point where others just feel heavy.

TDI®

A turbocharged, fuel-sipping variant, our TDI® clean diesel engine delivers uncompromising Audi performance with bold efficiency.¹ Yes, it gets better mileage per gallon than comparable gasoline engines, but it also produces more low-end torque, which is best expressed in the elasticity you have when passing in the 30- to 60-mph range.

FSI®

The Audi FSI direct injection fuel management and delivery system directly injects fuel into the combustion chambers at precisely managed times and depths. What that means for drivers is that a fully homogenized intake charge helps increase power while also reducing fuel consumption and emissions, making efficiency more powerful.¹

TFSI®

At Audi, TFSI represents a combination of two of the brand's core areas of expertise—direct injection and forced induction. By adding forced induction (turbocharging or supercharging) to Audi FSI direct injection, the pressurized intake charge is cooled by directly injected fuel, thus achieving efficiency and performance combined with higher compression ratios—previously only attainable by naturally aspirated engines.¹

¹ See www.fueleconomy.gov for EPA estimates. Your mileage will vary. ² Obey all speed and traffic laws.



Mobile Wi-Fi® hotspot

Provides high-speed connectivity for up to eight passenger devices through an onboard wireless hub.^{1,3}



City events

Get information about current events, exciting locations and places of interest at your travel destination, current location or other chosen location instantly.³



myAudi features

Plan travel from your personal computer. Send your desired destinations to your vehicle ahead of time and access your route from your vehicle later.³



Google Voice™ Local Search

Simply tell your Audi what you are in the mood for, then let the cloud-processing power of Google™ speech recognition interpret your request and bring up a list of destinations in the area of your choice.³



Google Earth™ with 3D satellite imagery

With Google Earth™ integration, you'll enjoy 3D satellite imagery, including Google Maps Street View, displayed right on the Audi MMI display.³

It's Audi because

spicy chicken is your destiny.

If you are craving an Audi, we know your tastes run a little bold. But what happens when you crave spicy chicken, or a nice vindaloo, or some pepper salsa? Well, in your Audi, you can just say the word, and we'll help find the heat. With available Audi connect®,¹ we've developed a way to seek out your destiny, even if that's just finding the closest gas station, or the best hotel. Audi connect integrates Google™ technol-

gies, like Google Earth™ with 3D satellite imagery, with Audi MMI® Navigation plus.² It also provides Wi-Fi® connectivity for up to eight passenger devices to help you stay informed. Check local fuel prices, weather information and, yes, the closest Szechuan restaurant using Google™ Local Search capabilities. Think of where that might take you.^{1,3}

1. Always pay careful attention to the road, and do not drive while distracted. The features and technologies discussed above are optional, may require an additional subscription with separate terms and conditions, and should be used only when it is safe and appropriate. The Wi-Fi® hotspot feature is intended for passenger use only. 2. Audi MMI® Navigation plus depends on signals from the worldwide Global Positioning Satellite network. The vehicle's electrical system and existing wireless and satellite technologies must be available and operating properly for the system to function. The system is designed to provide you with suggested routes in locating addresses, destinations and other points of interest. Changes in street names, construction zones, traffic flow, points of interest and other road system changes are beyond the control of Audi of America, Inc. Complete detailed mapping of lanes, roads, streets, toll roads, highways, etc., is not possible, therefore you may encounter discrepancies between the mapping and your actual location. Please rely on your individual judgment in determining whether or not to follow a suggested Audi MMI® Navigation plus route. Periodically mapping updates will be available for purchase at an additional cost. Consult your dealer or call 1-800-FOR-AUDI for details. 3. Optional features. Features and technologies listed will not be available on all models.





Elephant skull

How nature solved the apparent conundrum of an elephant's skull didn't escape the notice of Heinrich Timm, the longtime lead engineer for Audi. The weight of the tusks and the general size of an elephant's head would seem to make it impossible for the animal to actually be able to carry it. But the design genius behind the elephant's skull is actually to make it lightweight, yet sturdy. Its predominantly hollow design is buffered by thin, connective bone walls, which act as strong, weight-bearing cells. Audi designers used that idea when building our aluminum and steel structures. Reducing weight, yet enabling strength.

Aluminum

Our large aluminum castings are a telling example of Audi ultra® lightweight technology. Primarily used in high-stress areas, these multifunctional castings achieve exceptional rigidity while also allowing for freedom of design, all while remaining extremely lightweight.¹



It's Audi because

the elegant structure of nature becomes a blueprint of efficiency.

It seems strange to say that, while we build strong, complex and high-performing machines, we're naturalists at heart. Then again, it might not be that unusual, seeing how nature itself builds strong, complex and high-performing machines as well. When we developed the thinking behind our Audi ultra® lightweight technology initiative, we knew that nature would serve as an inspiration to greater structural efficiency. Take the structure of the elephant skull pictured here. It has to be lightweight, yet capable of carrying a heavy load. It's porous, but its structure is such that it enhances its stability and

strength. We do the same, for example, with aluminum. Positioned one way, aluminum materials can be flexible. Positioned another, they are strong and rigid, and give better support. We also looked to bamboo, which is strong at the conjoined areas (nodes), and flexible along its stem. Our designs allow for both rigidity and flexibility where each is most needed, and for efficiency overall.² As we continue to develop strategies to improve the performance aspects and efficiency of our vehicles, we don't shy away from the world around us.² We boldly engage it even closer still.

¹ Features and technologies listed will not be available on all models. ² See www.fueleconomy.gov for EPA estimates. Your mileage will vary.



It's Audi because

you I.D. our eye queue.

Even if you knew nothing about Audi, you'd still know if you were staring at one because we are unafraid to stare back. In fact, that exchange might just be love at first sight. That's how much our iconic LED lighting technology stands out from the pack. So we had the bright idea to make our LED daytime running lights look even more in-

tense. Now featuring a solid, sleek diode design that ingeniously reinvents our signature style, Audi LED lighting technology is once again unmistakably ours. It is an efficient, beautiful way to help you see and be seen during dawn and dusk. Look deeply into our eyes, and you'll know the truth of our attraction.¹

¹ Features listed are available on all models.



1 Steering wheel

The Audi steering wheel is both an ergonomic command center and an elegant structure of performance. Easily accessed controls on the wheel give you control over your MMI® and Audi connect®, while it is designed to give you effortless access to visual information on the driver information display.^{1,2}

2 Audi connect and MMI

Simple voice or finger motions can help you access information, music and BLUETOOTH® enabled features.^{1,2}

3 Electromechanical parking brake

Properly positioned in the center console, the parking brake control is another small, but telling, design cue for Audi. The parking brake control serves to enhance the overall ergonomic intent of the vehicle, while delivering easy access and simple functionality.¹

4 Bang & Olufsen® Advanced Sound System

With retractable acoustic lenses and speakers positioned around the Audi specifically to optimize sound quality, Bang & Olufsen® engineers have worked tirelessly with Audi sound designers to create an immersive audio experience.¹

It's Audi because

optimized design makes your commute shine a little brighter.

Get away from it all, every day, around 6 p.m., when you leave work and enter into a customized world that's completely dedicated to your comfort and entertainment. This place, of course, is the cabin of your Audi. Optimized luxury, designed by committed craftsmen who have you in mind when they choose the leather seating surfaces, create the adjustable seats or provide the refinement of ergonomic design and a more intuitive MMI. There are small touches that help simplify the overall design, like a

stylish contoured electromechanical parking brake at the foot of the center stack and an available Bang & Olufsen® retracting acoustic lens, perfectly positioned for richly detailed sound quality. And there are large statements, like a steering wheel with easily accessed controls to help you feel comfortably at ease. It is your Audi interior, where you leave the world behind, even when the world might seem in front of you on the way home.¹

1 Optional features. Features and technologies listed will not be available on all models. 2 Always pay careful attention to the road, and do not drive while distracted. The features and technologies discussed above are optional, may require additional subscription with separate terms and conditions, and should be used only when it is safe and appropriate. The Wi-Fi hotspot feature is intended for passenger use only.

It's Audi because

it's as if we have SPF for seats.

With innovative pigments and dyes, the Thermocool technology Audi uses in select leather seating surfaces just might prevent that startling moment on hot sunny days. You know the one, when you sit down and feel, immediately, an intense, searing feeling on your leg. Now you can keep your cool. This supple leather doesn't heat up as

much in direct sunlight as traditional leather does. In fact, the difference between untreated leather and the temperature on your seat treated with Thermocool can be as much as 86°. A perfect solution for your Audi A5 Cabriolet, TT Roadster or R8 Spyder, Thermocool technology is Audi to its core. Because it keeps its cool, you can keep yours.



Reduce as much as **86°F**

¹ Images shown are for dramatization purposes only.

AUDI

The story of our collection of obsessions.

Precision. Design. Vision. These are the kind of attributes that we deliver as a company, the kind of passions that go way past getting you from point A to point B. That's because Audi knows that how you get to your destination is only part of the story. And so it is with us as a luxury brand. Our obsessions are our commitments, a collection of inspirations that make up our core truth: That from a foundation of brilliant engineering, we craft more than great vehicles—we tell great stories.

Q5

We've put you at the center of it all.

After discovering who we are as a brand, take some time to see how that translates into the creation of an incomparable SUV. What you'll find is a vehicle that puts all its attention on you and keeps it there with unrivaled luxury, technology and performance. Consider it the antidote to the traditional sport utility vehicle.

BE CAUSE



Design

We do not follow design trends. We set them.

This is how the world looks when it revolves around you.

We're not saying you're the type who always needs to be the center of attention, but when you're sitting behind the wheel of the 2014 Audi Q5, that's exactly what you'll feel like. You might even say that, with this much emphasis on style, the Q5 is a magnet for looks by those who appreciate timeless design. It doesn't hurt that it boasts an unmistakable profile to complement its sporty yet sophisticated style. Or that it provides some serious fuel-saving potential, courtesy of the Q5 hybrid model or newly available Audi TDI® clean diesel engine.^{1,2,3} Its interior, of course, makes for a progressive and luxurious escape from the outside world. With that said, imagine all the possibilities that the available advanced technologies on board can make real, from helping you find a new restaurant using the power of Google™ Local Search to providing almost limitless entertainment courtesy of SiriusXM® Satellite Radio, to dialing in your personal comfort. In here, you can expect to permanently steal the limelight.



1. The Q5 hybrid is available in the U.S. in limited quantities and only at participating Audi dealers. 2. Q5 2.0T, 3.0T and Q5 hybrid EPA estimates not available at time of printing. See www.fueleconomy.gov for updated information. Your mileage will vary. 3. 24 city/31 highway/27 combined mpg (2014 Q5 TDI® clean diesel with eight-speed Tiptronic® automatic transmission and Audi quattro® all-wheel drive). EPA estimates. Your mileage will vary.

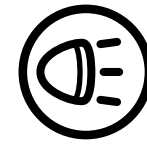

Enlighten

Shedding a new light on illumination just happened to be a design boon.

Don't be afraid to flash a little muscle.

There's nothing wrong with showing off when it's done with some class. Take a walk around your Audi Q5, and you'll quickly realize why this vehicle isn't shy. Its striking wheels are highlighted by the elegant arc of the fenders, while the gracefully sloping roofline, accentuated by aluminum roof rails, evokes a coupe-like presence. From the front, the Audi Singleframe® grille takes center stage with an assertive, unmistakably Audi look, while available xenon plus headlights and signature LED daytime running light technology let the masses know you worked hard to look this good.

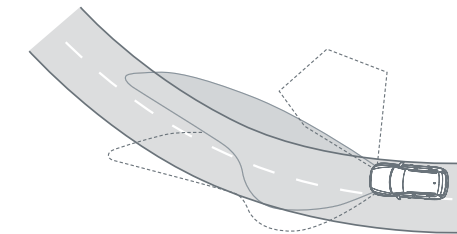

Adaptive xenon plus headlights

When driving straight, the headlights disperse light over a wide area while also casting light farther down the road on the passenger's side to help provide better long-range visibility.

Swiveling up to 15 degrees, the available adaptive xenon plus headlights direct light based on steering wheel input so that you can easily track the road ahead.

Activated when you use the turn signal, the cornering light illuminates the area to which you intend to go, giving you a well-lit path even before you initiate the turn.

Dropping the weight for all the right reasons.

It's surprising how many benefits are gained by shedding just a few pounds, let alone many. So it should come as no surprise, then, that we went to great lengths to reduce weight when engineering the Audi Q5. Beyond improving handling significantly, there is an even greater benefit that comes with a reduction in weight. By using aluminum in such components as the hood, tailgate, wheels and suspension, we shed a significant amount of unwanted weight, helping to diminish the load on the engine and increase overall drivability and efficiency.¹ That's how we turned our loss into your gain.



Power tailgate

With a unique clamshell design that seamlessly integrates into the rear, the available power tailgate on the Q5 gives you programmable end points so you can adjust the opening to the height you choose—a big help in tight spaces.

¹ EPA estimates not available at time of printing. See www.fueleconomy.gov for updated information. Your mileage will vary.



Weight-saving aluminum

Using aluminum helps reduce weight while still making for a structurally sound vehicle. And in no place is this more evident than in the all-aluminum tailgate. It weighs markedly less than a typical steel tailgate, due to its lightweight aluminum structure and clamshell design, and helps provide exceptional structural integrity.



19" alloy wheels

Adding to the already striking exterior presence are available 19" alloy wheels designed to show off the powerful stance of the Q5.

The image shows the front interior of a 2014 Audi Q5. The view is from the driver's perspective, looking towards the center console and dashboard. The steering wheel is black with the Audi logo in the center. The dashboard is dark grey with wood inlays. The center console features a gear shifter, handbrake, and various controls. The seats are upholstered in brown leather. The background shows a city skyline across a body of water.

Peer into your perfectly crafted universe.

Look closely, and you'll notice how luxury and style have joined in perfect harmony. Consider the driver-oriented layout, where every control, gauge and switch have been placed with convenience in mind. Take another look around, and you'll also notice the high-quality materials and fine craftsmanship that envelop every square inch. From the standard Brown Walnut Wood inlays to the carefully stitched leather seating surfaces, to the available three-spoke sport steering wheel, it all comes together to create an interior that exudes character. And when it comes time to find your favorite song or next destination, count on the available Audi MMI® Navigation plus to put it all right at your fingertips.¹ This is your universe—revel in it.

Wood inlays

Speaking to the detail and craftsmanship of the Q5 are premium genuine wood inlays. They are selected, crafted and matched to the color of the dashboard and leather seating surfaces to compensate for variations in texture and reflectivity.

¹ See Infotainment/Technology section of the Featured Content page for important information regarding the Audi MMI® Navigation plus system.

Comfort rules in any configuration.

We don't believe versatility should impose limits on comfort. That is to say, no matter how much you reconfigure the interior of your Audi Q5, it won't impede your driving enjoyment. Available twelve-way, power-adjustable front seats give you almost unlimited options when it comes to personal comfort, while sliding and reclining rear seats make sure your passengers are included in this luxurious experience. And just try to exhaust the possible configurations afforded by the 40/20/40 split folding rear seats. We'll go out on a limb and say you can't. Let's just put it this way—you may never run out of ways to enjoy your Q5.



Adjustable rear seats

An adjustable rear bench enables the rear seats to recline 10 degrees, move forward or back 3.9 inches and fold completely flat, allowing for flexible cargo configurations and additional rear leg room when needed.

Twelve-way power front seats

Perfect comfort for both the driver and front passenger is just a touch of a button away with the available twelve-way power front seats.





It feels good to open up in a setting like this.

In here, you don't have to talk about your feelings to become more open. It just happens on that perfect drive, when you can feel a cool breeze as sunlight fills the cabin. That's because, in the Audi Q5, we've imagined ways to create a unique, light-filled interior that warms while it calms. We've also developed systems that help deliver personalized comfort to the driver as well as to both the front and rear passengers. And when it comes time to pick up that new armoire, you'll rest easy knowing you have plenty of cargo space to work with.



Panoramic sunroof

The available two-panel panoramic sunroof offers both the front and rear passengers an unobstructed view overhead while flooding the cabin with natural light. And when you decide you need to say goodbye to the sun, a power sunshade is there to make it an easy task.

Three-zone automatic climate control

With three distinct climate zones, the driver, front passenger and rear passengers can set their perfect level of heating or cooling with a simple twist of a dial on the center console.

Rear cargo area

Designed with the family road trip or ski vacation in mind, the Q5 doesn't hold anything back when it comes to holding your luggage. Offering 29.1 cu ft of cargo capacity with the rear seatbacks up, and up to 57.3 cu ft with the rear seatbacks folded down, there's enough room to bring just about anything you'll need. Now the only problem? Where to go next.

Our terrain is not defined by topography.

The luxurious Audi Q5 was designed with unruly roads in mind. That means, luxury aside, those gravel-strewn switchbacks and steep, graded highways are effortless terrain for the Audi quattro® all-wheel drive system. Audi quattro® is designed to help provide maximum grip and optimized power delivery for practically all sorts of road conditions. So while your commute may not be as thrilling as a trip to the summit, you can be confident in the balance and enhanced performance Audi quattro® offers you wherever you go, while giving you no good excuse for taking a snow day.¹



▼ 56°F to 78°F



↑

All-around confidence

Just like life, the road can throw you a curve. So throw one right back with the superior grip and control of quattro®. It helps provide the performance and confidence you would expect from Audi, no matter if you're commuting in the city or crisscrossing the country. This is advanced engineering you can live with.



¹ When driving during cold, rainy, snowy or icy weather conditions, ensure that your vehicle is equipped with appropriate all-season or winter tires. Even with appropriate tires, you must always drive in a manner appropriate for the weather, visibility and road conditions.

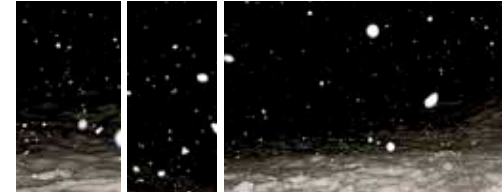

▼ HUMIDITY 95%



↑

All-weather capability

There is a reason quattro® is considered such a friend in foul weather. Under normal driving conditions, the center differential splits torque at a ratio of 40:60 front to rear, but as conditions change and become more challenging, the ratio is optimized to help maximize grip. And with the ability to transfer the majority of available torque mechanically to the wheels with the most grip, the operation is exceptionally smooth, even under extreme conditions.¹



↑

Torque vectoring

It's a handling feature that seems to respond to your impulses before your steering input. An evolution of cross-axle lock, this system works within quattro®, while utilizing ESC and ABS to help sense traction loss from the inside cornering tire.



↓



▼ WIND 54 mph



Make a selection that just feels natural.

With four different modes expressing your individual driving preferences, the exclusive Audi drive select system available in the Audi Q5 helps give you the ability to adjust the vehicle's steering, throttle response, suspension and transmission shift characteristics. It helps you articulate how you want your Q5 to respond to the drive. The four modes of Audi drive select cover the full spectrum of driving and road conditions. So whether driving on a winding country road or a busy interstate, there is a mode that helps your vehicle respond the way you want it to. Since the roads you drive are not always optional, we think how you choose to drive them should be.

1

Comfort mode

Perfect for less-than-perfect roads, this setting adds optimized suspension and steering and a closer shift pattern to help provide a more relaxed drive.

2

Dynamic mode

Tighter steering, a firm suspension and a more responsive throttle give this setting an aggressive feel and focused performance.

3

Auto mode

The best of both worlds, dialed to automatically adjust settings for a seamless combination of comfort and responsiveness based on your driving style and road conditions.

4

Individual mode

Take the turn your way—this mode allows you to adjust the steering, suspension, throttle and transmission upshifts to your style.



Transmission

From very responsive, quick gear changes to more gradual acceleration, the transmission is at the heart of Audi drive select.



Throttle-mapping

Depending on the mode of Audi drive select you choose, the throttle can be precisely responsive or a little less so.



Steering/Suspension

When you turn the steering wheel, you expect the vehicle's steering and suspension to react accordingly. Audi drive select helps give you more input on how that will feel.

This is how power accelerates.

Consider it the beating heart of your Audi Q5. Whether you choose the acclaimed 2.0 TFSI® engine that delivers impressive torque and punchy off-the-line acceleration while still returning excellent fuel economy or the supercharged 3.0 TFSI engine that delivers the potent performance of a traditional V8 with the thirst of a V6, you can count on improved miles per gallon¹ and more beats per minute. We call that a win-win.

Induction technology—TVS supercharger

Compressing the airflow to the engine forces more air into the cylinder and, ultimately, more power from each ignition, significantly improving the engine's power-to-displacement ratio.

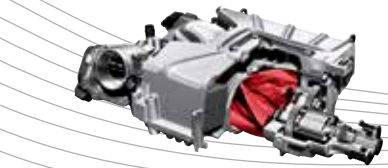

Maximum boost pressure up to 11.6 psi

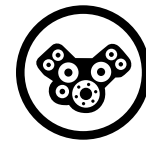

Four-vane w/160° twist Three-vane w/60° twist

Performance

The adage "good things come in small packages" has never been more true.

↑ ↑

More twist for power

Modern supercharger rotor-vanes have a 160° twisted shape for higher pressures and improved efficiency. And by using a four-vane design instead of a three-vane design, thermal efficiency and air-handling characteristics are improved without increasing the size of the supercharger unit.

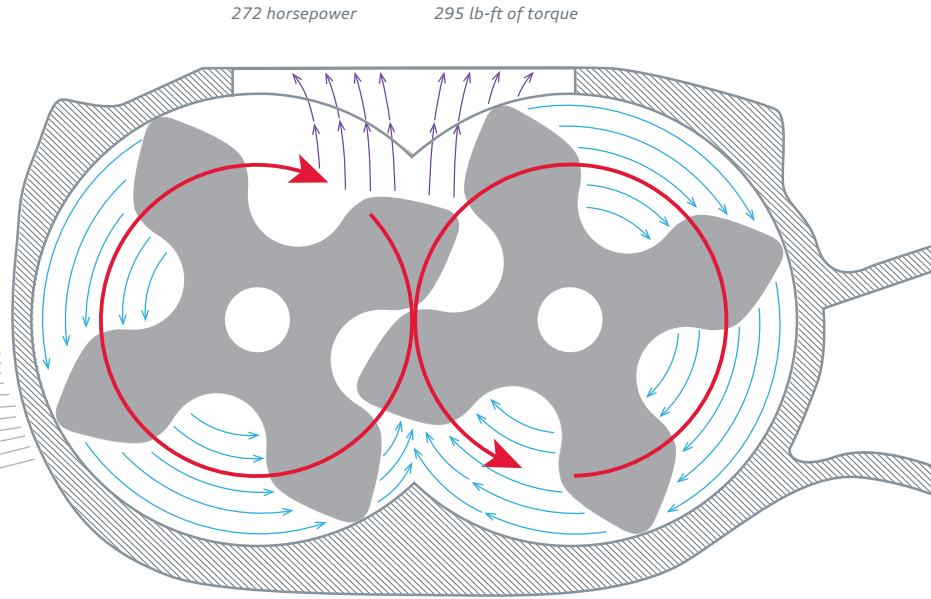

3.0 TFSI V6 supercharger illustrated above

3.0 TFSI V6

The 272-horsepower 3.0-liter TFSI V6 engine is paired with FSI® direct injection and a belt-driven supercharger that has counter-rotating four-vane rotors, rotors that then force air through dual intercoolers at boosted pressures of up to 11.6 psi. It is this combination of engineering achievements that allows for nearly instantaneous buildup of 295 lb-ft of torque directly off idle engine speeds.

Start-stop efficiency system

As an intelligent vehicle system, this highly effective engine management program can lower fuel consumption as well as CO₂ emissions by automatically shutting off your engine while you wait at a red light or, perhaps, during certain stop-and-go driving. Once you are ready to resume, or if other critical vehicle systems require it, the engine will restart nearly instantaneously.²

2.0 TFSI four-cylinder

This 2.0-liter turbocharged DOHC engine produces 220 horsepower and 258 lb-ft of torque, and combines the valvelift system, Audi FSI® direct injection and turbocharging for great power and overall efficiency.¹

Eight-speed Tiptronic® automatic transmission

As the perfect compromise between a dedicated manual and an automatic gearbox, the eight-speed Tiptronic® automatic transmission in the Audi Q5 offers eight optimized, carefully chosen gear ratios. Selected automatically or via its console-mounted shifter or steering wheel with available shift paddles, precise shifts are delivered without sacrificing the smooth action of the Tiptronic® automatic. A high final drive ratio allows optimization of lower gears, yet the transmission's upper range emphasizes fuel economy—particularly at highway speeds.¹

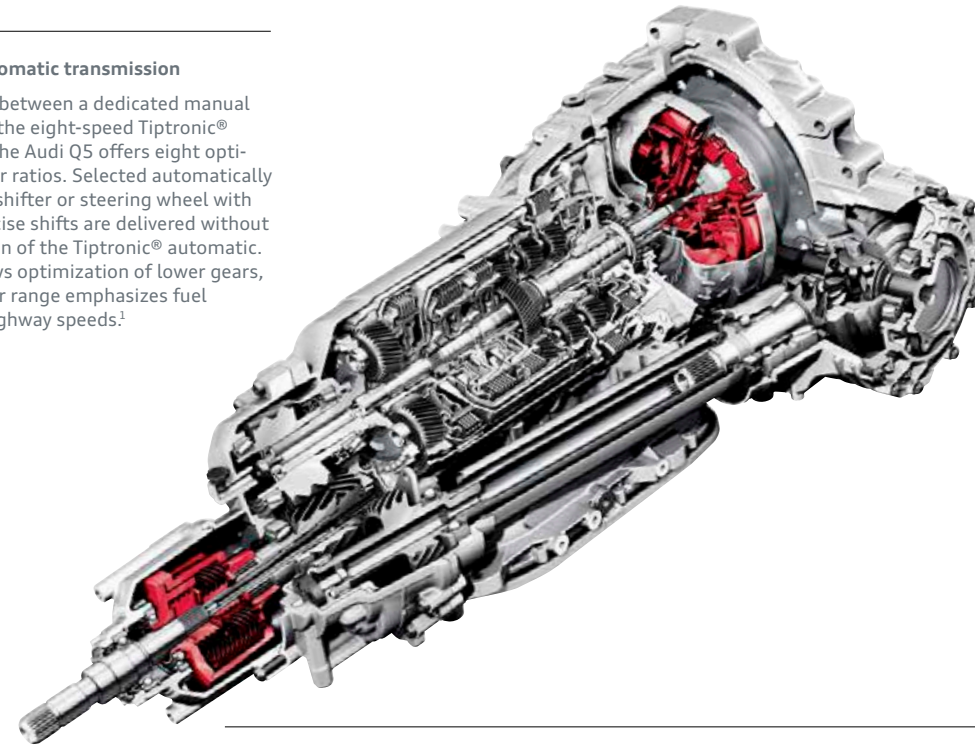

gear	ratio
1ST	4.714:1
2ND	3.143:1
3RD	2.106:1
4TH	1.667:1
5TH	1.285:1
6TH	1.000:1
7TH	0.839:1
8TH	0.667:1

With efficiency comes great power.

Putting all the blame on your engine for poor acceleration is the easy way out. In many cases, the transmission is the real culprit. The Audi Q5 eliminates the problem with a revolutionary transmission. By utilizing optimized gear ratios, the eight-speed Tiptronic® automatic transmission is capable of transferring power in the most responsive and efficient way possible, all while allowing the driver to command upshifts or downshifts through the available steering wheel-mounted shift paddles. What you do with your newfound power is your choice.

¹ EPA estimates not available at time of printing. See www.fueleconomy.gov for updated information. Your mileage will vary. ² Start-stop engine efficiency system standard on 3.0T, TDI® and hybrid models.

Fuel for thought.

We thought you should know: Diesel sports a greater power density than traditional gasoline, which means that a gallon of diesel fuel has about 15% more energy than a comparable amount of gas, and combusts more efficiently in the engine. The Audi TDI® clean diesel engine has achieved ultra-low emissions vehicle (Bin-5/ULEV) status in all 50 states while producing approximately 20% fewer CO₂ emissions than the traditional gasoline-fueled engine. And the brainy attributes don't hide the brawn—in fact, Audi has dominated the 24 Hours of Le Mans over the years with Audi TDI® prototype race cars. With these facts in mind, maybe you are thinking that an Audi TDI® might be your choice—which goes to show that clean diesel really is fuel for thought.

→→ → TDI® clean diesel

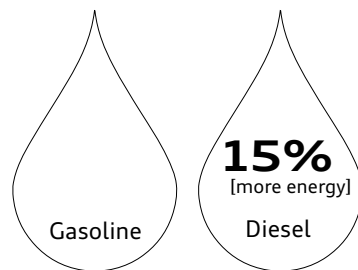

↑ ↑

Diesel packs more energy

On average, one gallon of diesel contains about 147,000 BTUs, versus 125,000 for gasoline.

+



↑ ↑

Making diesel cleaner

A new refinement process binding sulfur molecules to hydrogen has reduced sulfur in diesel fuel by more than 97% in years past.

+

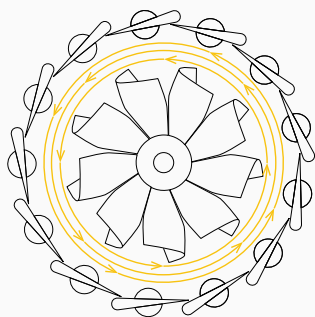

↑ ↑

Variable vane turbocharger

Adding turbo power to clean diesel engines, our adjustable vane turbocharger produces impressive torque punch and mid-range passing speeds.¹

+

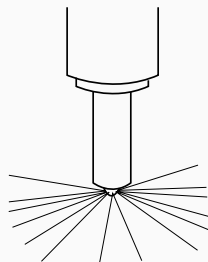

↑ ↑

Piezo direct injection

Precise injections help lower the combustion noise normally associated with diesel engines, while optimizing the distribution of fuel in the combustion chamber, helping to further reduce exhaust emissions.

+

↓

Engine

3.0-liter TDI® clean diesel V6 with 240 hp and 428 lb-ft of torque with AdBlue® exhaust after-treatment

↓

Drivetrain

Eight-speed Tiptronic® automatic transmission and Audi quattro® all-wheel drive

↓

Fuel economy

24 city/31 highway/27 combined²

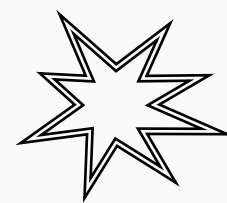

↑ ↑

Combustion

Combining a high compression ratio with direct injection makes combustion more efficient, and produces emissions cleaner than those of engines with a lower compression ratio.

+

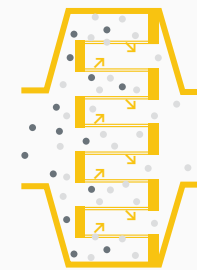

↑ ↑

After-exhaust treatment

With innovative diesel particulate filters and the nontoxic AdBlue® reducing agent, we eliminate up to 95% of diesel NO_x emissions.

=

up to
20%
more efficiency

↑ ↑

Increased fuel efficiency

Another way diesel creates fewer emissions is that it gets better mileage, up to 20% more mpg than comparable gasoline engines, in fact²

There is more information on the Audi TDI® clean diesel model line in the all-new 2014 Audi TDI® clean diesel brochure. See your dealer or go to audiusa.com for details.

¹ Obey all speed and traffic laws. ² 24 city/31 highway/27 combined mpg (2014 Q5 TDI® clean diesel with eight-speed Tiptronic® automatic transmission and Audi quattro® all-wheel drive). EPA estimates. Your mileage will vary.

Sending inefficiency to greener pastures.

The word hybrid has a different meaning around here. To us, it means twenty-first century performance. The relentless torque of an electric motor combined with the big horsepower of a combustion engine. But the Audi Q5 hybrid also proves that being efficient doesn't have to be a drag on straight-line thrills.^{1,2,3} By coupling the legendary Audi 2.0-liter TFSI® engine with a 54-hp electric motor, the total combined system output jumps to 245 hp, ensuring that the Q5 hybrid lives up to the strict performance standards of Audi, all while achieving fuel efficiency that leaves other luxury SUVs stinging with jealousy. Of course, this being an Audi, you'll be forgiven for not thinking about how efficiently you're getting from place to place, as you're wrapped in exquisite luxury.¹ It's time to send your old notions of a hybrid to a better place.



Hybrid appearance

Setting the Q5 hybrid apart from its siblings are subtle, stylized visual effects. Hybrid badges grace the rear hatch, fenders and doorsills, while the signature Audi Singleframe® grille features a custom high-gloss black finish. Hybrid-specific 19" wheels round out its elegant look.



Exclusive 19" 10-arm-turbine design wheels

2.0 TFSI with quattro®

Even without the aid of the electric motor, the Audi 2.0-liter TFSI engine is one formidable player. Add in the legendary handling of Audi quattro® all-wheel drive, and the Q5 hybrid provides as much poise as it does performance.

Power

245 hp/354 lb-ft of torque
↓ ↓

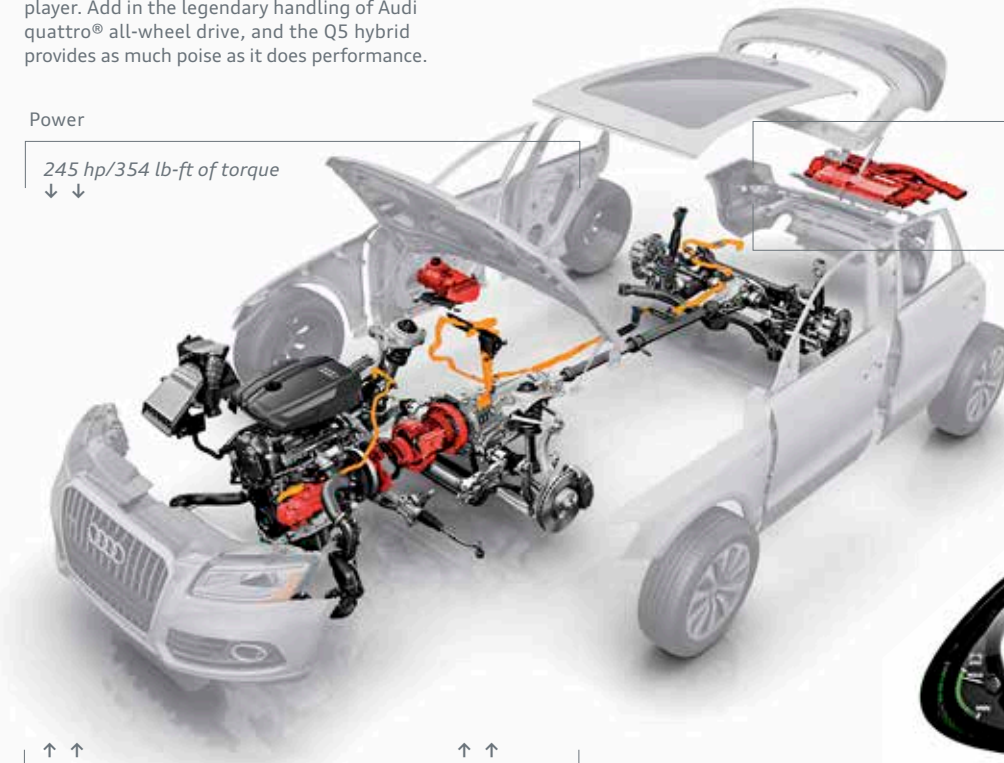

↑ ↑
6.8 seconds

↑ ↑
0-60 mph

Lithium-ion battery system

The advanced lithium-ion battery used in the Q5 hybrid serves as the energy storage unit for the electric motor. Its large energy reserves combined with the high-output 54-hp electric motor allows for full electric driving at speeds of up to 62 mph.

Power

266 volts/1.3kWh energy

battery weight 81 lb



Power meter

Taking the place of the tachometer, the power meter displays the hybrid system's total power output, providing efficiency information in real time.

Sailing mode

The Q5 hybrid features a unique hydraulic clutch between the engine and electric motor that disengages the engine when you lift off the accelerator at highway cruising speeds. The electric motor then takes over to propel the vehicle until more acceleration is needed. Called "sailing," the benefit is a gain in highway fuel economy, a result not typically associated with hybrids.¹

¹ EPA estimates not available at time of printing. See www.fueleconomy.gov for updated information. Your mileage will vary. ² The Q5 hybrid is available in the U.S. in limited quantities and only at participating Audi dealers. ³ Obey all speed and traffic laws.

We shed light on your blind spots.

Audi strives to constantly up the ante on the driver assistance tools built right into the vehicle. Evidence for this can be found in the available Audi side assist, which helps inform you if there are vehicles in the lanes next to you. Or in the available Audi adaptive cruise control, which helps monitor the distance between you and the vehicle ahead of you and adjusts your speed appropriately. You can also see it in something as simple as Audi parking system plus, which adds a rear view camera and front/rear acoustic parking sensors. All of these show the effort we put into helping ensure that you're not the only one keeping an eye on the road.



Driver Assist

We're solving problems before you even know you had them.



Audi adaptive cruise control

Everyone has their own comfort zone. The available Audi adaptive cruise control helps maintain a driver-selected distance from the vehicle in front by using a special long-range radar sensor. The system constantly measures the space between your vehicle and the vehicle ahead and helps maintain it by automatically adjusting your speed. Once the road ahead is clear, the vehicle effortlessly resumes the previously preset speed, helping to make your drive that much more relaxing.

Audi side assist

The available Audi side assist uses radar sensors and two different optical warnings to help keep the driver informed of what is approaching from hard-to-see angles behind and to the side of the vehicle.



We don't see safety as an option, or a luxury.

We decided that, regardless of size, strong should be a more flexible concept. High-strength steel helps add a measure of security while enhancing overall handling and performance. The six standard airbags¹ feature technology that is designed to deploy airbags based on seat position, while specially constructed crumple zones give way upon impact to help mitigate potential injury in a collision. All of this, combined with the rigidity of laser seam-welded joints that enhance the strength of every Audi we make, helps diminish the impact of an unavoidable event.



Dramatization²

Six standard airbags

With six standard airbags, including front-impact and thorax side airbags for both driver and front passenger, and available rear passenger thorax side airbags, you'll feel practically surrounded.¹ And that's a good thing.



Safety

Working to spread a "bend, don't break" philosophy.

Brakes

Whether you're on the open road or off the beaten path, ESC with ABS helps to keep the vehicle traveling in its intended direction by moderating brake pressure at all four wheels to help maintain traction, minimize skids and optimize control.

¹ Airbags are supplemental restraints only and will not deploy under all crash circumstances. Always use safety belts and seat children only in the rear, using restraint systems appropriate for their size and age. ² This is a dramatization and does not depict what will happen in a collision. All bags will not inflate simultaneously in real-world collisions, and, if multiple bags do deploy, they will be in various stages of inflating/deflating and will never all be inflated at the same time.

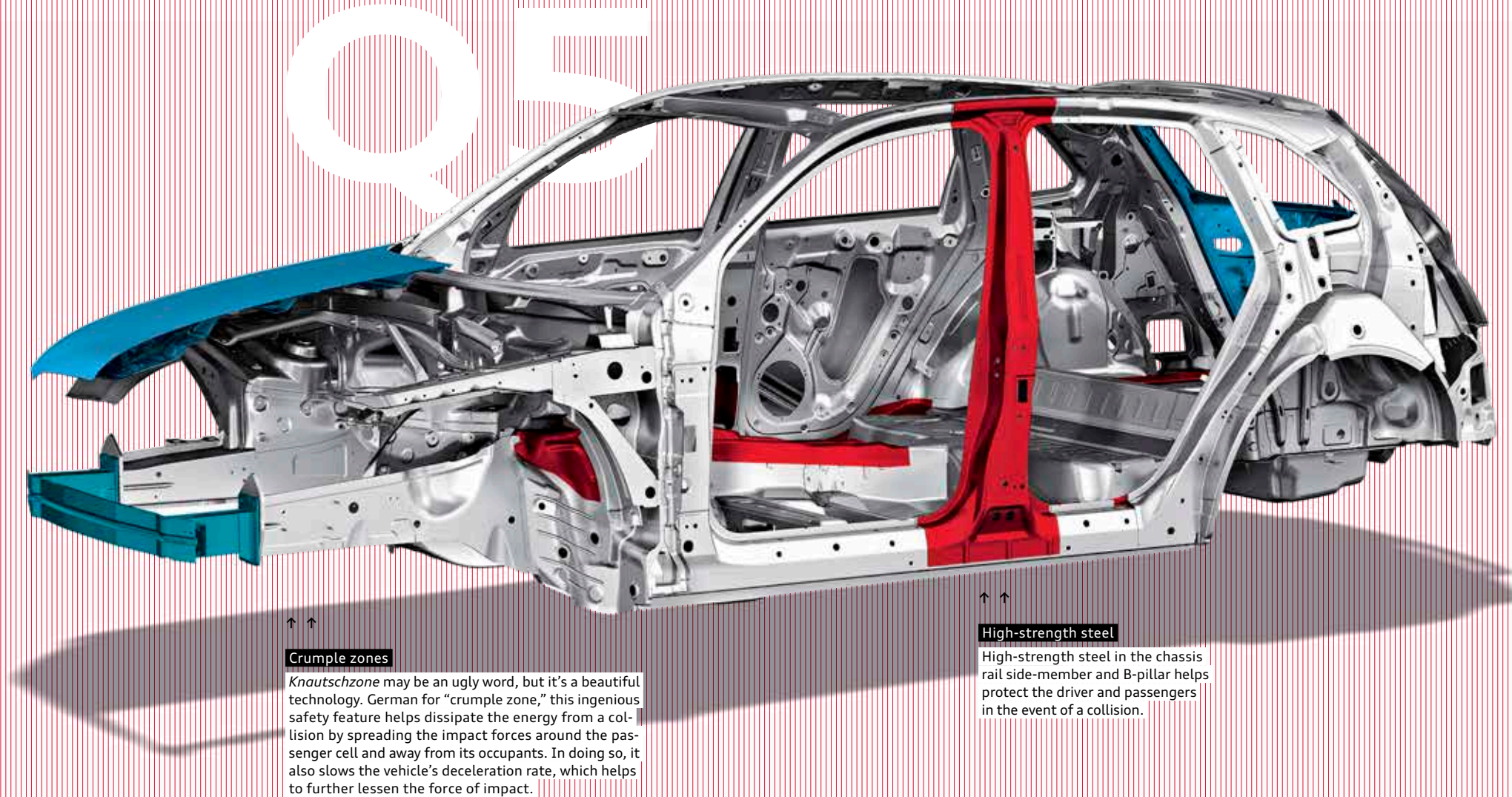

Crumple zones

Knautschzone may be an ugly word, but it's a beautiful technology. German for "crumple zone," this ingenious safety feature helps dissipate the energy from a collision by spreading the impact forces around the passenger cell and away from its occupants. In doing so, it also slows the vehicle's deceleration rate, which helps to further lessen the force of impact.

High-strength steel

High-strength steel in the chassis rail side-member and B-pillar helps protect the driver and passengers in the event of a collision.

Car consciousness.

We believe intelligence is key to a higher form of luxury. You can see this philosophy fully represented in the available Audi MMI® system. Simply put, it's an intuitive system that intimately connects you to almost every facet of the vehicle. It's the nerve center of your vehicle, allowing you to control virtually every interior function of your Audi with a simplified source control button system. From the Audi MMI Navigation plus, to the sound system, to media, MMI helps you access information with a few easy clicks. And even without it, you can pair your compatible phone with the vehicle for added convenience. With this kind of brainpower onboard, you can leave the little stuff to us, and just concentrate on how good it feels to drive.



MMI System

We've brought the backseat driver front and center.

SiriusXM® Satellite Radio

Go ahead. Crisscross the country. We assure you, you'll never run out of entertainment options, with over 130 channels of music, talk, sports and news.¹

Audi media

The media function opens up a world of options when equipped with the Audi MMI Navigation plus, allowing you to control the Audi music interface, Secure Digital (SD) card slots, hard disk drive (HDD) audio jukebox or DVD, and BLUETOOTH® streaming audio.^{1,2,3}

Audi MMI Navigation plus

Count on the available advanced navigation system to home in on your destination with stunning precision while putting a little more depth in your journey with help from Google Earth™.¹

BLUETOOTH® wireless technology

Unlock your mobile phone's potential through the MMI system. Simply pair them up and start enjoying near complete control at the touch of a button.³

¹ See Infotainment/Technology section of the Featured Content page for important information regarding Audi MMI® Navigation plus and required SiriusXM® subscriptions. ² Always pay careful attention to the road, and do not drive while distracted. The features and technologies discussed above are optional, may require an additional subscription with separate terms and conditions, and should be used only when it is safe and appropriate. The Wi-Fi® hotspot feature is intended for passenger use only. ³ Requires compatible phone.

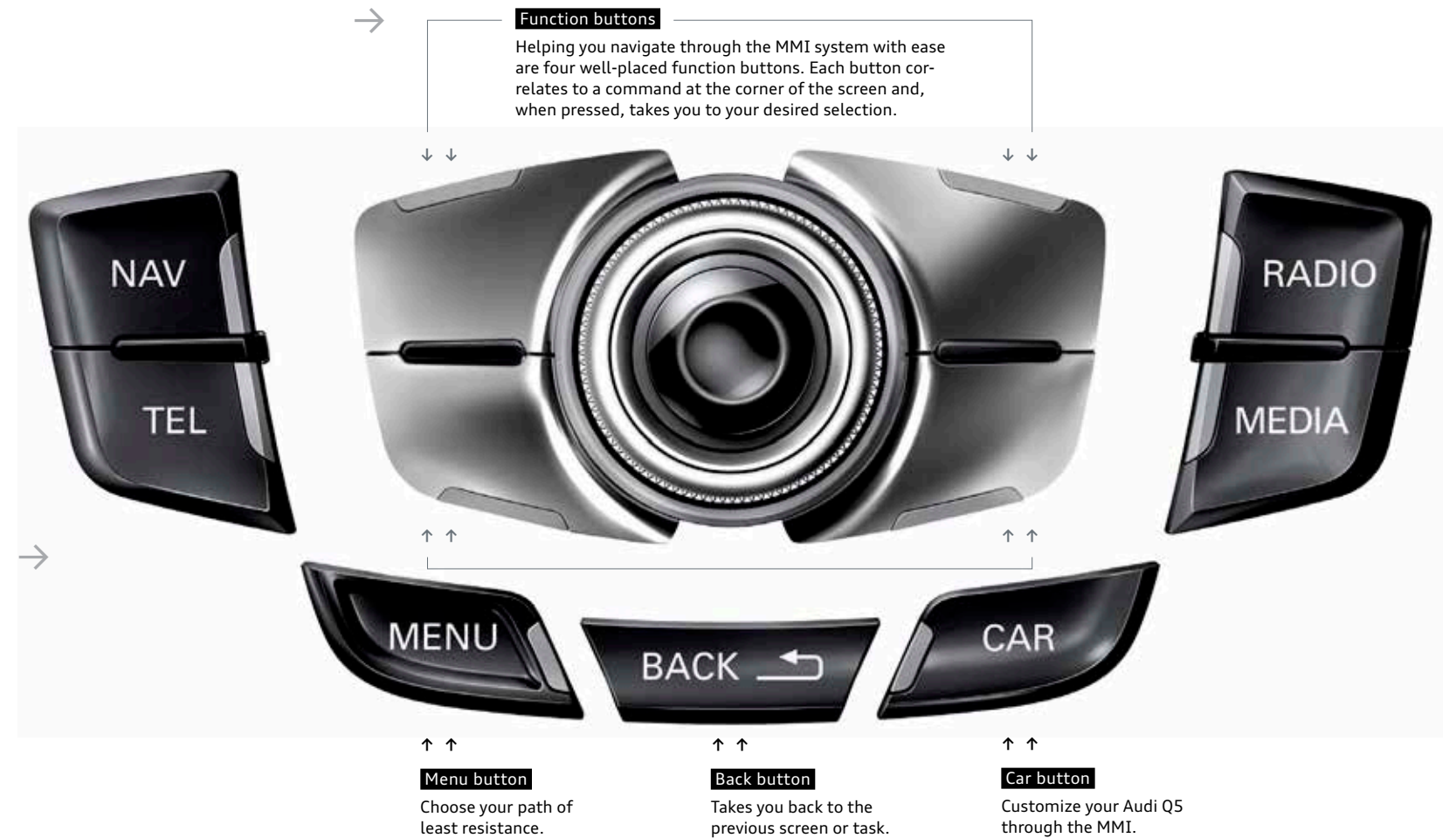

If nothing else, you know your car is listening to you.

Don't reach—relax. While touchscreens are seemingly everywhere, they don't need to be in your vehicle. With available Audi connect®, you may never have to reach out again.¹ Thanks to Google Voice™ Local Search, Audi connect allows you to search Google™ by simple voice commands. The crisp display is nestled farther up, closer to the windshield, so your eyes don't have to focus and refocus between the screen and the road ahead of you. For those times when you are feeling tactile, we've placed toggle buttons near the gear shifter, where your hand naturally rests while you drive. So while other automobile manufacturers still want you to reach out, we've found a few ways for you to make information a lot more accessible while your hands are on the wheel.

POI

Point-of-interest

The point-of-interest search with voice control means that the digital world is with you on every journey.

myAudi

myAudi features

Plan travel from your personal computer. Send your desired destinations to your vehicle ahead of time and access your route from your vehicle later.

NEWS

News feeds

Stay on top of the news by having headlines and stories delivered right to your Audi MMI® display.



Mobile Wi-Fi® hotspot

Provides high-speed connectivity for up to eight passenger devices through an onboard wireless hub.



SiriusXM® Traffic

Get traffic information overlaid onto 3D satellite imagery to visualize a true aerial view of your route, and let the Audi MMI Navigation plus system reconfigure your route to avoid traffic.²



Google Earth™ with 3D satellite imagery

With Google Earth™ integration, you'll enjoy 3D satellite imagery, including Google Maps Street View, displayed right on the Audi MMI display.



Weather information

Current local conditions and forecasts for your destination can help you prepare for your trip.



Google Voice™ Local Search

Simply tell your Audi what you are in the mood for, then let the cloud-processing power of Google™ speech recognition interpret your request and bring up a list of destinations in the area of your choice.



Google Maps Street View

With Google Maps Street View, your vehicle can show you a driver's-eye view of your destination right before you arrive so it's easy to recognize.



Parking information

Search for parking in your area of interest, check space availability and set your selection as a destination to navigate directly to the garage entrance.



City events

Get information about current events, exciting locations and places of interest at your travel destination, current location or other chosen location instantly.



Travel info

Discover local landmarks in your area of interest, set them as your destinations, and let your vehicle lead the way as you explore the world around you.

¹ Always pay careful attention to the road, and do not drive while distracted. The features and technologies discussed above are optional, may require an additional subscription with separate terms and conditions, and should be used only when it is safe and appropriate. The Wi-Fi® hotspot feature is intended for passenger use only. ² See Infotainment/Technology section of the Featured Content page for important information regarding required SiriusXM® subscriptions.



Sound

Audi is Latin for "listen," so you know we take sound very seriously.

When even a German lullaby is an ode to sound engineering.

It would be an interesting challenge, a note-perfect Brahms' Lullaby delivered through the tuned speakers of an Audi concert radio system versus the exhilaration of the passing lane. Either way, performance wins. But it goes way beyond the gentle tones of a German composer. Audi sound engineers don't simply make the cabin acoustics sound perfect for your music, they make the drivetrain sing. Or, if not sing, then put it in harmony with every other element of the driving experience. From the sound of a shutting door, to the click of a turning knob, to the full integration of an available Bang & Olufsen® Sound System, there's an orchestra of engineering that fills your cabin with faithfully rendered, thrilling sound. Whatever it is you are looking for, Audi sculpts sounds in a way that matches your mood, even when you need soothing while in traffic.

Bang & Olufsen® Sound System

Dedicated to the idea of "honest music reproduction," Bang & Olufsen® is a sound engineer's dream. Through an available 505-watt, 14-speaker system perfectly integrated within your Audi, Bang & Olufsen® is set on transcending the limits of audio technology. By automatically adjusting volume and timbre balance to changing ambient noise levels, and offering richly tuned acoustics, you'll hear the truth about how good life can sound in your Audi.

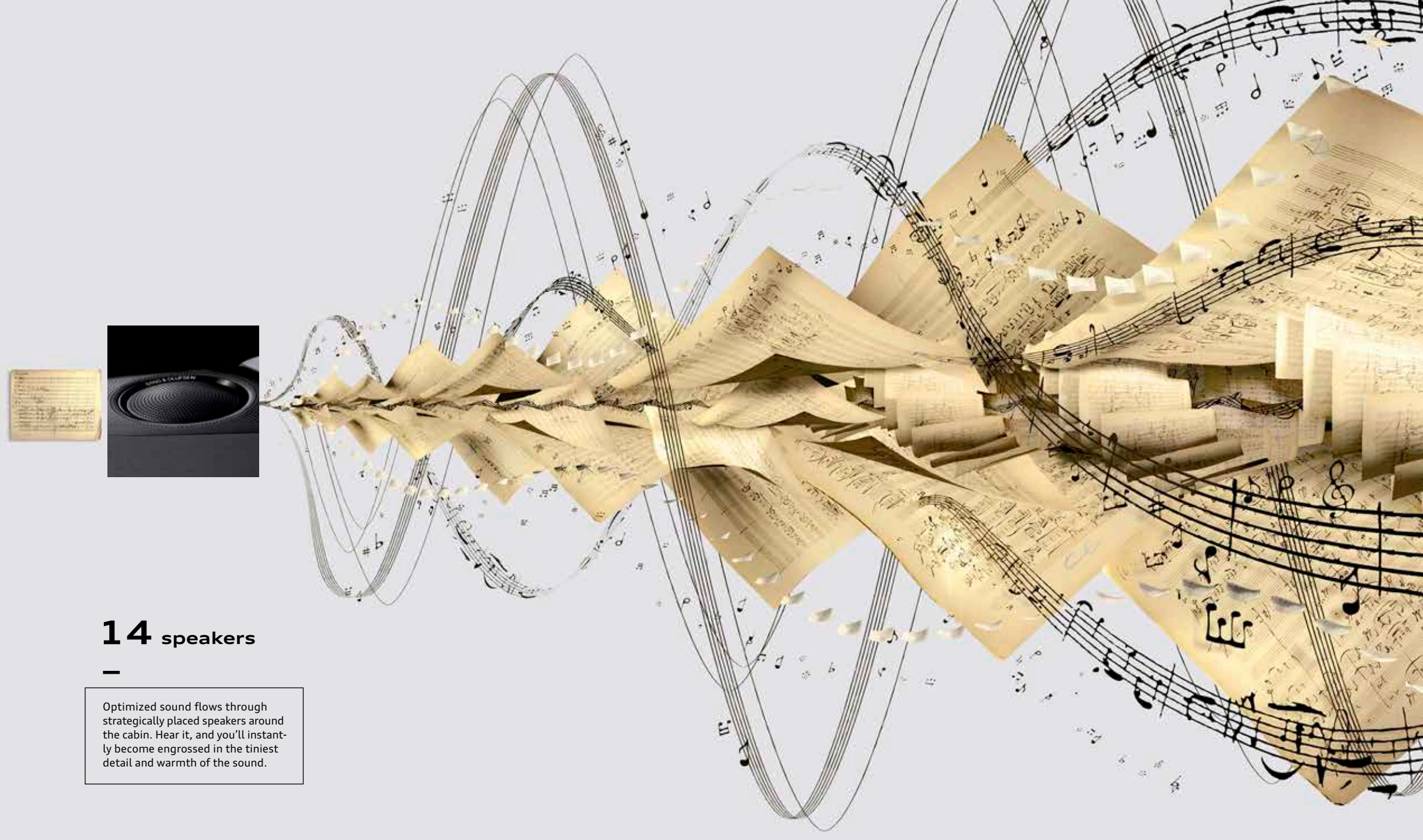

14 speakers

Optimized sound flows through strategically placed speakers around the cabin. Hear it, and you'll instantly become engrossed in the tiniest detail and warmth of the sound.



SQ5

ENGINE // 3.0-liter supercharged Audi TFSI® V6 engine developing 354 hp and 346 lb-ft of torque

DRIVETRAIN // Audi quattro® all-wheel drive, eight-speed Tiptronic® automatic transmission

CHASSIS // SQ5 tuned sport suspension, Audi drive select and available dynamic steering

BRAKES // 15.0" ventilated front disc brakes with S logo, 13.0" ventilated rear disc brakes

PERFORMANCE // Top track speed of 155 mph,¹ acceleration 0–60 mph in 5.1 seconds

¹ Top track speed is electronically limited in the U.S. Obey all speed and traffic laws.



A material vow to never hold back.

There's a way to tell people, "I'm in a league of my own," and still come off as modest. Introducing the all-new Audi SQ5. It's bursting at the seams with performance numbers—354-hp TFSI V6 engine, 346 lb-ft of torque, 0–60 in 5.1 seconds—but its sport stance and flared fenders will turn heads, even at a standstill. Add to that our signature LED taillight technology, standard on all Q5 models, that is as brilliant as it is unmistakably Audi, and a pair of beautifully sculpted quad exhaust outlets perfectly integrated into the lower bumper. It's our answer to the more reserved SUV.

Audi Sport

The story doesn't stop here. There's more on the full range of S, RS, and R8 Audi performance models in the **2014 Audi Sport brochure**. See your dealer or go to audiusa.com for details.

Exterior Colors

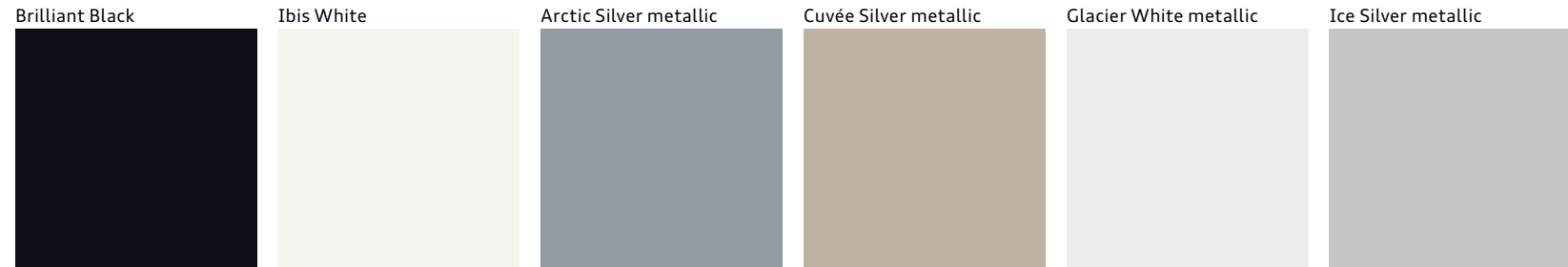

Q5 hybrid exclusive

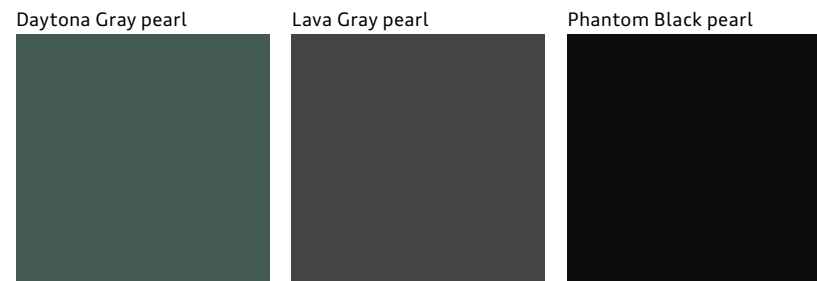
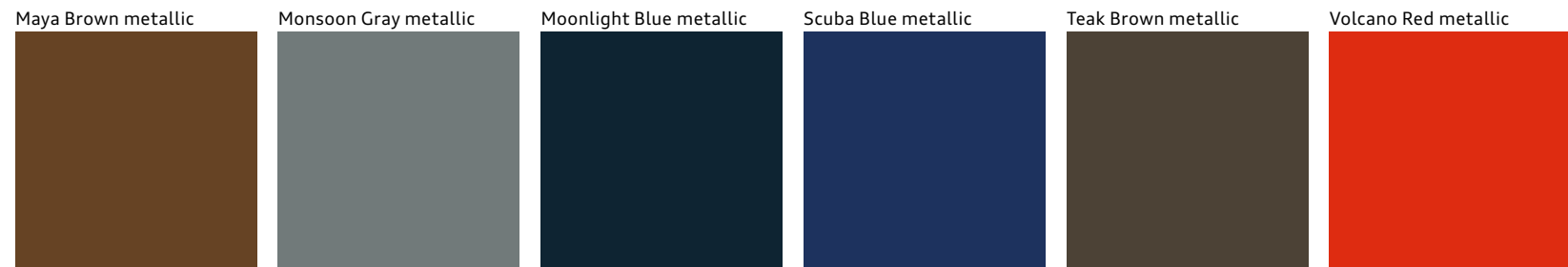

Audi S line®

Interior Colors | Seat Selections

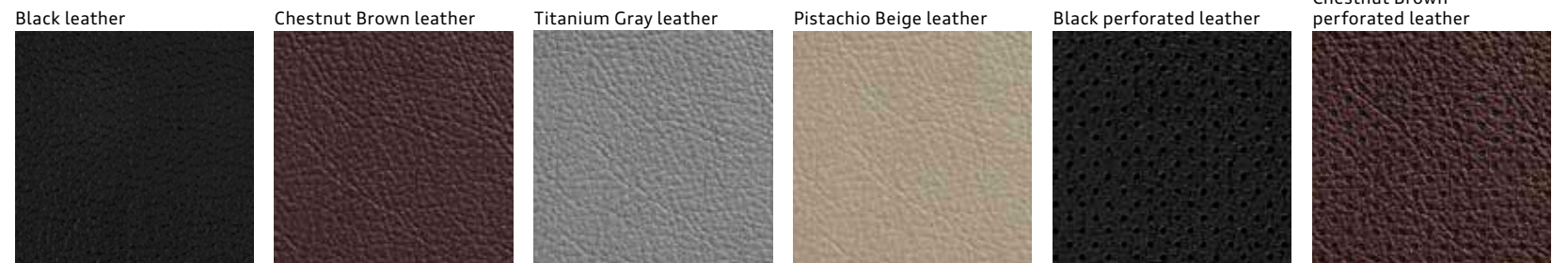

Standard, Sport

Standard, Sport

Standard

Standard

Comfort

Comfort

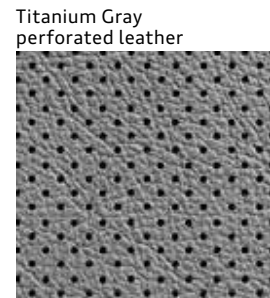

Comfort



Comfort



Audi exclusive line package, Sport

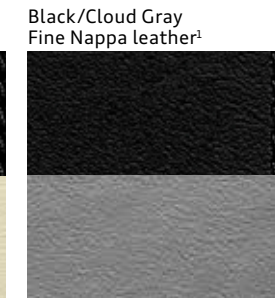

Audi exclusive line package, Sport

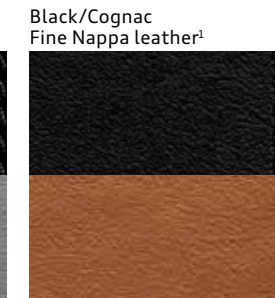

Audi exclusive line package, Sport

¹ Delayed availability.

Decorative Inlays

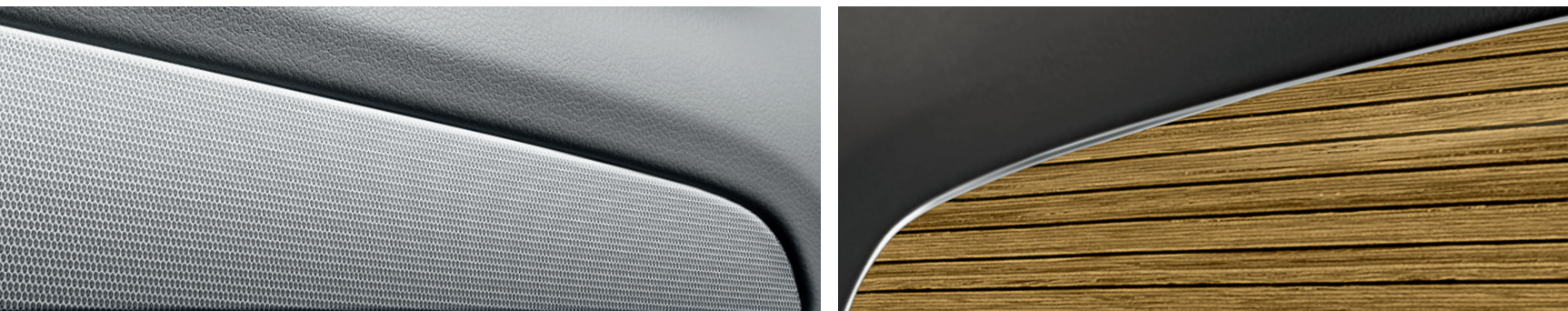

Brown Walnut Wood inlay

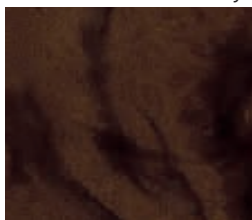

Aluminum Satellite inlay¹

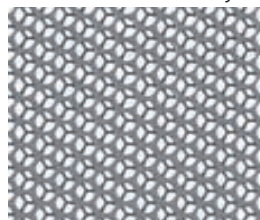

Fine Grain Ash Natural Brown Wood inlay¹

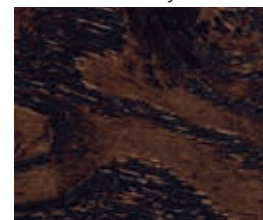

Layered Oak Wood inlay¹



Piano Black inlay¹

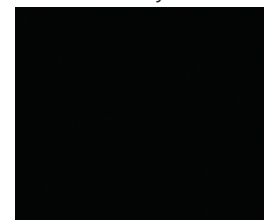

Audi exclusive line package²

Brushed Aluminum inlay¹



Audi S line[®] plus package, Audi exclusive line package (optional)²

¹ Decorative inlay options will vary based on model and interior color combination. See your dealer for details. ² Delayed availability.

Wheels

18" 5-spoke V design
235/60 all-season tires



Q5 2.0T Premium and Premium plus

19" 5-arm-star design
235/55 all-season tires



Q5 2.0T Premium plus (optional)
Q5 3.0T Premium plus and Prestige
Q5 TDI[®] Premium plus and Prestige

20" 5-segment-spoke design
(Titanium finish)
255/45 summer performance tires²



Q5 3.0T Premium plus and Prestige
(Audi S line[®] plus package)
Q5 TDI[®] Premium plus and Prestige
(Audi S line[®] plus package)

20" 5-arm design
255/45 summer performance tires²



Q5 3.0T Premium plus and Prestige (optional)
Q5 TDI[®] Premium plus and Prestige (optional)

19" 10-arm-turbine design
235/55 all-season tires



Q5 hybrid

20" 10-arm-turbine design
(Anthracite bicolor finish)
255/45 summer performance tires²



Q5 hybrid (optional)

19" 5-arm off-road design
235/55 all-season tires



Q5 hybrid (optional)

² Tires are supplied and warranted by their manufacturer. High-performance tires are designed for optimum performance and handling in warm climates. They are not suitable for cold, snowy or icy weather conditions. If you drive under those circumstances, you should equip your vehicle with all-season or winter tires, which offer better traction under those conditions. We suggest you use the recommended winter or all-season tire specified for your car or its equivalent. These high-performance tires also have a lower aspect ratio that aids performance and handling; however, in order to avoid tire, rim or vehicle damage, it is important that the inflation pressure is regularly checked and maintained at optimum levels. Please also remember in making your selection that, while these tires deliver responsive handling, they may ride less comfortably and make more noise than other choices. Finally, these tires may wear more quickly than other choices.

Technical Specifications

Engineering Performance	Q5 2.0T	Q5 3.0T	Q5 TDI®	Q5 hybrid
Engine type	Four-cylinder	Six-cylinder	Six-cylinder	Four-cylinder
Engine block/Cylinder head	Cast-iron/ Aluminum-alloy	Aluminum-alloy	Cast-iron/ Aluminum-alloy	Cast-iron/ Aluminum-alloy
Displacement (cc)/Bore and stroke (mm)	1,984/82.5 x 92.8	2,995/84.5 x 89.0	2,967/83.0 x 91.4	1,984/82.5 x 92.8
Horsepower (@ rpm)	220 @ 4,450–6,000	272 @ 4,780	240 @ 3,750–4,000	245 ¹ @ 4,300
Torque (lb-ft @ rpm)	258 @ 1,500	295 @ 2,150	428 @ 1,750–2,250	354 ¹ @ 1,500
Compression ratio	9.6:1	10.3:1	16.8:1	9.6:1
Valvetrain	16-valve DOHC with valvelift system	24-valve DOHC	24-valve DOHC	16-valve DOHC with valvelift system
Induction/Fuel injection	Turbocharged/TFSI®	Supercharged/TFSI®	Turbocharged/TDI®	Turbocharged/TFSI®
Start-stop efficiency system	—	■	■	■
54-hp water-cooled three-phase hybrid AC electric motor/generator	—	—	—	■
266-volt, 72-cell, lithium-ion hybrid battery system	—	—	—	■
Acceleration (0–60 mph)	7.0 seconds	6.0 seconds	6.5 seconds	6.8 seconds
Top track speed ²	130 mph	130 mph	130 mph	130 mph

Transmission | Drivetrain

Eight-speed Tiptronic® automatic transmission with Audi quattro® all-wheel drive (Gear ratios: 1st: 4.714, 2nd: 3.143, 3rd: 2.106, 4th: 1.667, 5th: 1.285, 6th: 1.000, 7th: 0.839, 8th: 0.667, Reverse: 3.317, Final drive: 2.848 for 2.0T models, 3.204 for 3.0T models, 3.076 for TDI® and hybrid models)	■	■	■	■
--	---	---	---	---

Body | Suspension | Chassis

Fully galvanized steel unibody with aluminum hood and tailgate and multi-step anti-corrosion protection	■	■	■	■
Five-link front suspension	■	■	■	■
Trapezoidal-link rear suspension	■	■	■	■
Adaptive damping suspension (Audi S line® plus package)	—	Available	Available	—
Ventilated front disc/Solid rear disc brakes (in)	12.6/11.8	—	—	—
Ventilated front disc/Ventilated rear disc brakes (in)	—	13.6/13.0	13.6/13.0	13.6/13.0
Electromechanical power steering system	■	■	■	■
Dynamic steering (Prestige)	—	Available	Available	—
Steering ratio	15.9:1	15.9:1	15.9:1	15.9:1
Turning diameter, curb-to-curb (ft)	38.1	38.1	38.1	38.1

■ Standard — Not applicable NA Information not available at time of printing

Exterior measurements	Q5 2.0T	Q5 3.0T	Q5 TDI®	Q5 hybrid
Wheelbase (in)	110.5	110.5	110.5	110.5
Length (in)	182.6	182.6	182.6	182.6
Height (in)	65.2	65.2	65.2	65.0
Overall width with mirrors (in)	82.2	82.2	82.2	82.2
Overall width without mirrors (in)	74.7	74.7	74.7	74.7
Track front/rear (in)	63.7/63.5	63.7/63.5	63.7/63.5	63.7/63.5
Curb weight (lb)	4,079	NA	4,475	NA
Drag coefficient (Cw)	.33	.33	.33	.33
Trailer hitch provision with 4,400-lb maximum towing capacity and 440-lb tongue weight ³	■	■	■	■

Interior measurements

Head room with sunroof (in, front/rear)	39.4/39.0	39.4/39.0	39.4/39.0	39.4/39.0
Head room with sunshade (in, front/rear)	38.1/37.7	38.1/37.7	38.1/37.7	38.1/37.7
Leg room (in, front/rear)	41.0/37.4	41.0/37.4	41.0/37.4	41.0/37.4
Shoulder room (in, front/rear)	57.7/56.4	57.7/56.4	57.7/56.4	57.7/56.4
Cargo volume (cu ft, rear seatbacks up/folded)	29.1/57.3	29.1/57.3	29.1/57.3	29.1/57.3
Seating capacity	5	5	5	5

EPA mileage estimates | Capacities

Tiptronic® automatic transmission (city/highway/combined)	NA ⁴	NA ⁴	24/31/27 ⁵	NA ⁴
Engine oil (qt)	4.9	7.2	6.8	4.9
AdBlue® (gal)	—	—	6.0	—
Fuel (gal)	19.8	19.8	19.8	19.0
Required fuel	Premium	Premium	Ultra-low-sulfur diesel	Premium



Technical specifications and featured content for Audi SQ5 can be found in the **2014 Audi Sport brochure**. See your dealer or go to audiusa.com for details.

¹ Combined gasoline engine and electric motor output. ² Top track speed is electronically limited in the U.S. Obey all speed and traffic laws. ³ Maximum tow rating when properly equipped with towing accessories. Other accessories and options may reduce maximum towing capacity. See vehicle owner's manual for details. ⁴ EPA estimates not available at time of printing. See www.fueleconomy.gov for updated information. Your mileage will vary. ⁵ EPA estimates. Your mileage will vary.

Featured Content

Safety Security	2.0T Premium	2.0T Premium plus	3.0T/TDI® Premium plus	3.0T/TDI®/hybrid Prestige
Driver and front passenger dual-stage airbags, front thorax side airbags and Sideguard® head curtain airbags ¹	■	■	■	■
Rear-passenger thorax side airbags ¹	Available	Available	Available	Available
Front passenger occupant detection for airbags ¹	■	■	■	■
Safety belt reminder for driver and front passenger	■	■	■	■
Lower Anchors and Tethers for Children (LATCH) in rear seats	■	■	■	■
Power central locking system with safety unlock feature if airbags deploy	■	■	■	■
Electronic Stability Control (ESC) with Off-road mode and traction control (ASR)	■	■	■	■
Anti-lock Brake System (ABS) with Electronic Brake-pressure Distribution (EBD) and brake assist	■	■	■	■
Tire-pressure monitoring system	■	■	■	■
Electromechanical parking brake	■	■	■	■
Anti-theft alarm system with immobilizer	■	■	■	■

Exterior	2.0T Premium	2.0T Premium plus	3.0T/TDI® Premium plus	3.0T/TDI®/hybrid Prestige
Audi Singleframe® grille	■	■	■	■
Gloss Black Audi Singleframe® grille	—	—	Available	Available/Available/—
Halogen headlights with daytime running lights	■	—	—	—
Xenon plus headlights with LED daytime running light technology	Available	■	■	—
Adaptive xenon plus headlights with LED daytime running light technology	—	—	—	■
Headlight washing system	—	—	■/Available	■/Available/—
Front and rear fog lights	■	■	■	■
LED taillight technology	■	■	■	■
Power-adjustable heated exterior side mirrors	■	—	—	—
Power-adjustable, power-folding, auto-dimming, heated exterior side mirrors with memory	—	■	■	■
LED turn indicator light technology integrated into the exterior side mirrors	■	■	■	■
Aluminum roof rails	■	■	■	■
Matte Black aluminum roof rails	—	—	Available	Available/Available/—
Aluminum trim around exterior windows	■	■	■	■
Gloss Black trim around exterior windows	—	—	Available	Available/Available/—
Power tailgate open/close	—	■	■	■
Flat-bottom dual exhaust outlets with polished tips	■	■	■	■
Audi S line® exterior appearance	—	—	■/Available	■/Available/—

■ Standard — Not applicable

Interior	2.0T Premium	2.0T Premium plus	3.0T/TDI® Premium plus	3.0T/TDI®/hybrid Prestige
Three-zone automatic climate control	■	■	■	■
Four-spoke multifunction steering wheel	■	■	■	■
Three-spoke multifunction sport steering wheel with shift paddles	—	Available	Available	Available
Three-spoke multifunction flat-bottom sport steering wheel with shift paddles	—	—	Available	Available/Available/—
Tilt and telescopic manually adjustable steering column	■	■	■	■
Auto-dimming interior rear view mirror with digital compass	—	■	■	■
Illuminated locking glove box	■	■	■	■
Leather-wrapped shift knob	■	■	■	■
Folding and sliding front center armrest with height adjustment	■	■	■	■
Eight beverage holders (four cup and four bottle)	■	■	■	■
Thermo cup holder	—	—	—	■
Decorative interior inlays (see Decorative Inlays page for more detail)	■	■	■	■
Aluminum door sill inlays	—	■	■	■
Ambient LED interior lighting technology	■	■	■	■
Black cloth headliner (with Chestnut Brown leather or Audi S line® plus package)	Available	Available	Available	Available
Dual front sun visors with lighted vanity mirrors	■	■	■	■
Power windows with one-touch up/down operation and pinch protection	■	■	■	■
Manual rear-side sunshades	—	—	—	■
Panoramic sunroof	Available	■	■	■
Panoramic sunroof deletion	—	Available	Available	Available

Seating	2.0T Premium	2.0T Premium plus	3.0T/TDI® Premium plus	3.0T/TDI®/hybrid Prestige
Leather seating surfaces (see Interior Colors page for more detail)	■	■	■	■
Perforated Milano leather seats, stitched door armrests and instrument panel top in Fine Nappa leather (see Interior Colors page for more detail)	—	—	—	Available
Audi exclusive line bicolor Fine Nappa leather seating surfaces ² (see Interior Colors page for more detail)	—	Available	Available	Available
Eight-way power front seats and four-way power lumbar adjustment for driver	■	■	■	■
Twelve-way power front sport seats, including four-way power lumbar adjustment	—	Available	Available	Available
Driver seat memory	—	■	■	■
Heated front seats	Available	■	■	■
Ventilated front seats	—	—	—	Available
Sliding 40/20/40 split folding rear seat with pass-through and adjustable recline	■	■	■	■

¹ Airbags are supplemental restraints only and will not deploy under all crash circumstances. Always use safety belts and seat children only in the rear, using restraint systems appropriate for their size and age. ² Delayed availability.

Featured Content

Infotainment Technology	2.0T Premium	2.0T Premium plus	3.0T/TDI® Premium plus	3.0T/TDI®/hybrid Prestige
Audi MMI® Navigation plus with voice control system ¹	—	Available	Available	■
Audi connect® with six-month trial subscription ²	—	Available	Available	■
Driver information system	■	■	■	—
Color driver information system	—	Available	Available	■
Audi concert radio with ten speakers and single CD player with MP3 playback capability	■	■	■	—
Bang & Olufsen® Sound System with 14 speakers and 505 watts	—	Available	Available	■
HD Radio™ Technology	—	Available	Available	■
SiriusXM® Satellite Radio with 90-day trial subscription ³	■	■	■	■
SiriusXM® Traffic with four-year subscription ³	—	Available	Available	■
SD card slot with 32GB operating capacity (dual slots if equipped with Audi MMI® Navigation plus)	■	■	■	■
Audi music interface with iPod® integration	■	■	■	■
BLUETOOTH® streaming audio ⁴	—	Available	Available	■
BLUETOOTH® wireless technology preparation for mobile phone ⁴	■	■	■	■
Four 12-volt power outlets	■	■	■	■
Garage door opener (HomeLink®)	■	■	■	■
Audi advanced key—keyless start, stop and entry ⁵	—	■	■	■
Cruise control with coast, resume and accelerate features	■	■	■	■
Audi adaptive cruise control	—	—	—	Available/Available/—
Audi side assist	—	Available ⁶	Available ⁶	■
Audi drive select	—	—	Available	Available/Available/—
Parking system plus with rear view camera	—	Available	Available	■
Rain/light sensor for automatic windshield wipers and headlights	■	■	■	■

■ Standard — Not applicable

¹ Audi MMI® Navigation plus depends on signals from the worldwide Global Positioning Satellite network. The vehicle's electrical system and existing wireless and satellite technologies must be available and operating properly for the system to function. The system is designed to provide you with suggested routes in locating addresses, destinations and other points of interest. Changes in street names, construction zones, traffic flow, points of interest and other road system changes are beyond the control of Audi of America, Inc. Complete detailed mapping of lanes, roads, streets, toll roads, highways, etc., is not possible, therefore you may encounter discrepancies between the mapping and your actual location. Please rely on your individual judgment in determining whether or not to follow a suggested Audi MMI® Navigation plus route. For mapping updates please see your Audi dealer or call 1-800-FOR-AUDI for details. ² See the Audi connect® page for important information about Audi connect®. ³ SiriusXM® Satellite Radio and Traffic subscriptions sold separately or as a package after trial expires. SiriusXM® Traffic service available in select markets. Subscriptions are governed by SiriusXM® Customer Agreement (see www.siriusxm.com) and are continuous until you call SiriusXM® to cancel. SiriusXM® U.S. Satellite Service available only to those 18 and older in the 48 contiguous U.S.A., D.C. and Puerto Rico (with coverage limitations). ⁴ Requires compatible phone. ⁵ Some Audi models are equipped with a keyless ignition feature. The details as to how the system works can vary, and Audi owners should consult their owner's literature or an authorized Audi dealer if they have further questions about the operation of this feature. Please note that Audi warns against leaving the vehicle unattended with the engine running, particularly in enclosed spaces. ⁶ Delayed availability.

A pinnacle of style just reached new heights.

Take the Audi Q5, a vehicle already emanating style. Add in Audi S line® plus exterior features like a specialized Black-optic Audi Singleframe® grille and stunning 20" Titanium-finish wheels. Then step it up on the inside with a three-spoke flat-bottom multifunction sport steering wheel with shift paddles, a beautifully crafted S line shift knob, Brushed Aluminum inlays and a Black cloth headliner. Now it's quite obvious, style just hit its peak.



Accessories

Add a new point of view, a dash of distinction and the ultimate in self-expression with Audi Genuine Accessories. Whether you load the cargo carrier with climbing gear or add a set of sporty new wheels, we've got the accessories that will help enhance every facet of your lifestyle. Designed for seamless compatibility with your Audi,

all pieces are backed by your vehicle's 4-year/50,000-mile limited warranty or the accessory's 12-month/12,000-mile limited warranty, whichever extends longer from the accessory purchase date! If you're looking to personalize or protect, Audi offers an intelligent solution.



Trailer hitch

This towing hitch is approved for a maximum load-carrying capacity of 4,400 lb for a properly equipped Audi Q5. For more information on towing, contact your dealer or see your owner's manual.

Umbrella case

This umbrella holder includes a mounting adapter that replaces the hook on the passenger side of the center console making it easily accessible. Includes Audi pocket umbrella.



Ski and snowboard rack

Push-button, keyed locks open and close easily. Rubber-cushioned aluminum bars hold securely. Standard attachment (shown) holds two sets of skis or two snowboards. Deluxe attachment holds up to three sets of skis or four snowboards.^{2,3}

Compact cargo carrier²

A trim, aerodynamic design that offers a generous 16.95-cu-ft capacity. Size: 81" long, 30" wide, 15" high.



Aluminum bike rack

This locking holder fits 20- to 80-mm bike frames with both wheels on the bike and helps keep the bike upright as you secure it in place.^{2,3}

Splash guards

Help protect the vehicle's finish with custom-fit splash guards. Made of crack-resistant rubber. Available in sets of two for front or rear. Not compatible with S line® models.



All-weather cargo mat

Custom fit for the Q5. Textured material helps control load shifting. Raised lip helps contain spills and protect cargo area carpeting from stains.

Cargo net

Help secure almost anything, from groceries to sports gear, with this expandable net. It hooks to tie-downs in the cargo area and easily adapts to items of different shapes and sizes.



Premium textile floor mats

These skid-resistant, precision-fit mats are made of long-life fabric to help protect the vehicle's interior from the elements. Mats are black with silver piping and available in sets of two or four.

Q5 all-weather floor mats

Nubbed design helps protect the floor and carpeting from water, mud, sand and snow. Black mats feature the vehicle logo and are available in sets of two for front or rear.



20" 10-spoke wheels

Add a more powerful, sporty look with this eye-catching design. Shown in silver. Also available in Anthracite.

20" 7-V design wheels

Give your vehicle a more unique presence with this Audi designed, Silver wheel.

Other accessories not shown

→ Audi Genuine Sport and Design Accessories

→ Your Audi vehicle features a bold, aggressive stance and strong, stunning lines. Enhance it by adding Audi Genuine Sport and Design Accessories. All are carefully scrutinized in the design and development process. So while they're striking in appearance, they've also passed rigorous quality assessments. If you're looking for a bolder appearance or a finishing touch, there is a solution designed by Audi that makes every mile more enjoyable—and more yours.

Audi Genuine Alloy Wheels

Strike the perfect balance between breathtaking design and awe-inspiring performance with Audi Genuine Alloy Wheels. Audi experts have meticulously designed these wheels especially for each Audi model. They're engineered to the highest standards and endure rigorous testing to help ensure long-term quality. Experience eye-catching style that is yours and yours alone. Nothing enhances the bold, dynamic look of your Audi vehicle faster.

¹ See dealer for details. ² All roof-rack system attachments require the base carrier bars. All attachments sold separately. ³ Recreational equipment, sporting equipment and luggage not included.