



A5 S5

Audi A5 Coupe | A5 Cabriolet
Audi S5 Coupe | S5 Cabriolet

Audi
Truth in Engineering 

Declaring war on the Windsor knot.

From the first rev, it's unmistakable—this is open-collared driving for those who think standing out is better than blending in. The substance is there, of course, with an intense combination of available powertrains, including the controlled power distribution of Audi quattro® all-wheel drive, an eight-speed Tiptronic® or a six-speed manual transmission that helps deliver dynamic handling and response, and FSI® and TFSI® engines that provide punch with surprising efficiency.¹ But this isn't a static blueprint, this is a driver's car. Coupe or Cabriolet, both the A5 and S5 were engineered by, and for, those who prefer experience to formality. Take the wheel. Leave the tie.



In a sidekick world, embrace alpha style.



.01 - Perfect Proportions

Nothing feels out of place in an A5, and that's by design. Its streamlined $\frac{2}{3}$ body, $\frac{1}{3}$ greenhouse design allows its sleek roof to flow seamlessly from its long hood. This is contrasted elegantly by short overhangs at front and rear, giving this sports car its signature aesthetic.

~ fig. 01

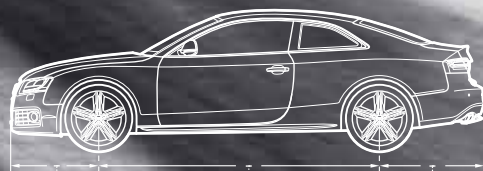

short overhang optimum wheelbase short overhang

When even commuter cars are trying to look like something more than a box on wheels, the A5 takes a slightly different approach to style. Think of it as the difference between a marketing gimmick and designed sophistication. Our style isn't simply to provoke, but to articulate a confident vision. In either Coupe or Cabriolet body styles, the A5 has the capacity to charm as well as energize. From its driver-centric cabin to the signature flow of its roofline, the A5 is an uncompromised expression of pure style.



~ fig. 02

.02 - LED Daytime Running Light Technology

Stylish and iconic, available LED daytime running lights enhance the unmistakable look and design of the Audi A5, as well as its visibility to other drivers, especially during the dawn and dusk hours.

Sometimes it's
as much about
SPF as RPM.

When dynamic curves are designed expressly for the interplay of light and shadow across the cabin when the top is down, you know you are in a visionary kind of cabriolet. That's if you want to notice. Otherwise, you can enjoy the more direct pleasures of a top-performing cabriolet—potent acceleration, poised handling and smiling with abandon, wondering how you ever drove without sunscreen.

0. seconds

4. seconds

14. seconds

17. seconds



top up¹

The top of the Audi A5 and S5 Cabriolet invites you to take advantage of clear skies for as long as the sun is out. If clouds do come, it takes approximately 17 seconds for drivers to fully deploy its roof (even at speeds up to 31 mph), so you can practically beat the first drop you see.



¹ Timeline shown does not accurately reflect soft-top operation and is for explanatory purposes only.

This is where you picture yourself behind the wheel.

If the cockpit feels like home, it's because it was designed that way. Built-in comforts like simple, intuitive controls help you streamline your driving experience, while the available Audi MMI® Navigation plus with voice control system helps bring convenience and innovation to the instrument panel.¹ By the time you reach out and touch the wraparound curve of the instrument panel or interact with the controls on the steering wheel, you'll see how seamlessly you and this driver-centric layout fit together.

¹ See Audi MMI® Navigation plus page for important information regarding the Audi MMI® Navigation plus system.



~ fig. 03

.03 - Audi Singleframe® Grille

Emulating the iconic front grille that's become a part of the Audi legacy, this steering wheel center piece, emblazoned by its four-ring hallmark, presents itself as the fulcrum of the well-appointed A5 interior.

Where luxury makes itself felt. Caressed, even.

Classic Audi fit, finish and materials add more than a little sophistication to an impressive, athletic profile. Rich inlays like Burnished Wood and Cinnamon Brown Milano leather seating surfaces add a visual warmth to the cabin, or you can go bold with available color leather seating surfaces and Brushed Aluminum inlays. Either way, with thoughtful appointments like standard power front seats, automatic climate control, and available heated front seats, comfort takes center stage.



.04 - Ventilated and Heated Seats

Available on Cabriolet models, the head-level heating system offers luxurious and therapeutic temperature control, allowing both driver and passenger to enjoy the splendor of a convertible, even in cooler climates.



quattro

A particularly German take on performance art.

Despite what rear-wheel-drive aficionados like to brag about, the loss of traction is not performance. That's why the A5 delivers its impressive performance through its available road-gripping Audi quattro® all-wheel drive system. More than a new toy to show your friends, its dynamic handling and performance shines through in all seasons and in a wide range of weather. And with available technologies like Audi drive select and sports differential with torque vectoring on the S5, we've created a more dynamic all-wheel drive system that has set the new standard for the industry for the foreseeable future.

.05 - Audi quattro®

Audi quattro® all-wheel drive is based around a torque-sensing, self-locking, center differential that assists in shifting torque to where it's needed most. For the driver, that means Audi quattro® adjusts power between front and rear axles to help optimize control and performance.

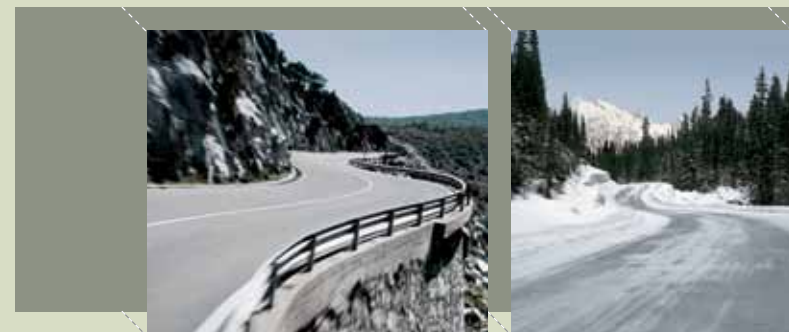
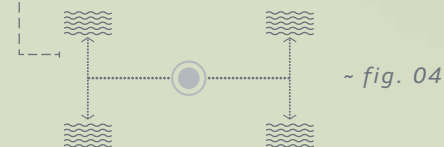

The drive is responsive, but we also demand that you respond to the drive. Available Audi drive select gives you Comfort, Auto and Dynamic settings that cater to both your mood and the surrounding conditions.



.06 - Torque Vectoring

It's a handling feature that seems to respond to your impulses before your steering input. An evolution of cross-axle lock, this available system works within Audi quattro®, while utilizing ESC and ABS to help sense traction loss from the inside cornering tire.

overdrive speed difference via internal step gear

clutch in power flow

hydraulic actuation

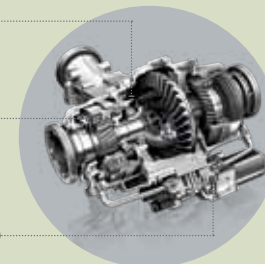

Sophisticated Handling

Lightweight Aluminum Suspension Parts

The use of weight-saving aluminum for critical components helps the suspension to respond rapidly during decisive, split-second situations on the road.

Five-link Front Suspension

With the finely tuned front-suspension components secured to the subframe, the five-link front suspension increases ride quality by helping isolate road harshness and vibration to the cabin.

Rear Suspension

By helping to maximize friction between the vehicle's rear tires and the road, the Audi A5 and S5 offer a stable base from which their power and torque can be extrapolated throughout.

Dampers and Springs

Properly absorbing bumps on the road means more than just a comfortable ride. Our system of dampers and springs helps the driver gain control during adverse driving situations.

Real power is proving four is greater than six.

It's time to change the equation when it comes to engine performance. The first thought is that six cylinders are automatically better, and sometimes, that's true. But in a field of performers, the Audi A5 holds its own with four. That's because it features the Audi 2.0 TFSI®—a pioneering engine that combines the direct injection of gasoline with efficient and powerful turbocharging technology. Producing 211 hp and 258 lb-ft of torque, the 2.0 TFSI has been the engine of choice for more than 1.3 million Audi drivers worldwide.

.07 – 2.0 Turbocharged Four-cylinder

Years ahead of the competition, this 2.0-liter turbocharged DOHC engine combines the Audi valvelift system, variable valve timing, TFSI direct injection and turbocharging for more power and greater efficiency.¹

Compressing the air flow to the engine allows more air into the cylinder and ultimately more power from each ignition, significantly improving the engine's power-to-displacement ratio.

Audi FSI® direct injection helps cut down on waste and increases power by delivering a precise amount of fuel directly into the engine cylinder, helping ensure a more complete combustion.

With higher compression ratios and cylinder pressure, the TFSI engine fully atomizes fuel and helps optimize boost response.

The combination of these advanced technologies allows Audi to use a smaller, more efficient engine that still achieves excellent power and performance results.

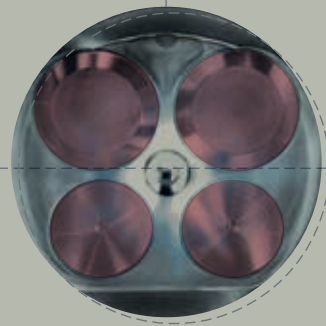

Four valves per cylinder

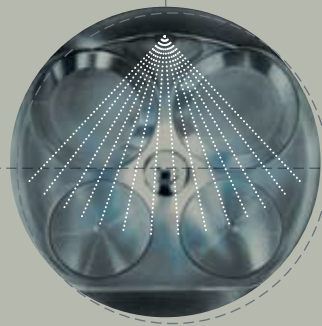

211 hp / 258 lb-ft of torque

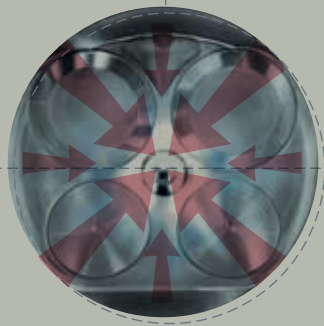

22 city / 30 hwy mpg¹

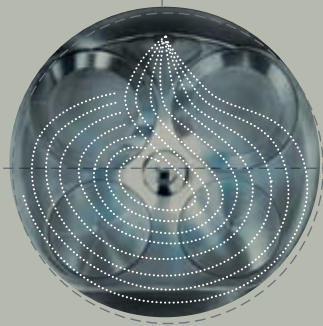

0 - 60 mph 6.2 seconds²

.08 – Eight-speed Tiptronic® Automatic Transmission

As the perfect compromise between a dedicated manual and an automatic gearbox, the available eight-speed Tiptronic® automatic transmission in the Audi A5 offers eight optimized, carefully chosen ratios. Selected via its console-mounted shifter or steering wheel with optional shift paddles, precision shifts are delivered without sacrificing the smooth action of the Tiptronic® automatic. A wide final drive ratio allows optimization of lower gears, yet its upper range emphasizes fuel economy—particularly at highway speeds.¹

.09 – Six-speed Manual Transmission

For drivers who crave engaging and dynamic response, both the Audi A5 and S5 Coupes present an available six-speed manual gearbox which delivers power with vintage Audi finesse. Its short throw and precise ratios add a contemporary element for confident performance on the road.

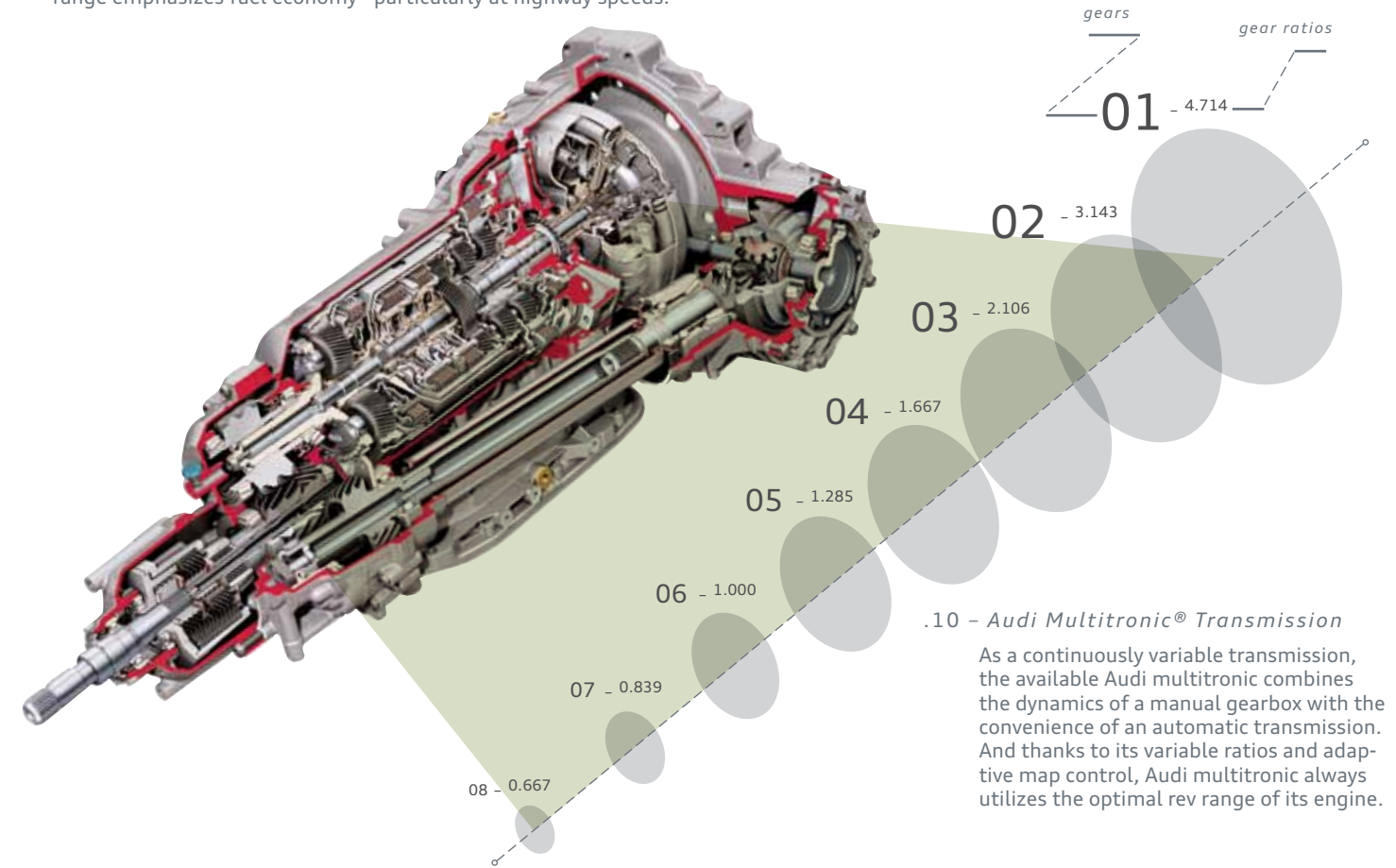

.10 – Audi Multitronic® Transmission

As a continuously variable transmission, the available Audi multitronic combines the dynamics of a manual gearbox with the convenience of an automatic transmission. And thanks to its variable ratios and adaptive map control, Audi multitronic always utilizes the optimal rev range of its engine.

With these kinds of performances, you might not care how efficient you've become.

¹ EPA estimates. Your mileage will vary. See www.fueleconomy.gov for details. ² 0-60-mph times will vary from model to model. Always obey local speed and traffic laws.

S

The performance coupe's performance coupe.

The S5 doesn't take anything away from the A5—it only adds. The S5 Coupe, for example, adds a potent 4.2 FSI® V8 that features 354 hp, while the S5 Cabriolet adds a supercharged 3.0 TFSI® with 333 hp. It brings an agile, aggressive stance to an already powerful profile. And with a stiffer suspension, it helps to enhance its already dynamic handling. But most of all, the S5 is sleekly styled, propulsive energy for those who want to take performance to a more progressive level.



S5

S5 Coupe



Engine

We give you the freedom to rev away with the Audi 4.2 FSI V8 in the S5 Coupe. Delivering a robust 354 hp and 325 lb-ft of torque to an impressive performance portfolio, it's muscle, yes, but stylishly applied, so you look athletic, not bulked up. In addition, a sports differential can be added to Audi quattro® all-wheel drive, helping to give you more handling ability by actively controlling the torque distribution to the rear wheels, making for tighter cornering and sure-footed driving.¹

Transmissions

The six-speed manual and the optional six-speed Tiptronic® both offer smoother and more precise shifting through the gearbox, emphasizing a fast, energetic response. The manual puts you at center stage while the Tiptronic® adds automatic/manual flexibility and efficiency to your transmission.^{1,2}

S5 Cabriolet



Engine

Top-down driving with true power, the supercharged 3.0 TFSI V6 in the S5 Cabriolet brings efficiency to a formidable mix of 333 hp and 325 lb-ft of torque. With the top down, the performance engine puts a little kick into your cruising. Top up, it's an unmistakable sports car feel, with the power augmented by the superior handling afforded by Audi quattro® all-wheel drive with available sports differential to help cornering and provide dynamic handling.^{1,2}

Transmissions

The innovative S tronic® comes standard on the S5 Cabriolet. A dual-clutch gearbox capable of delivering incredibly quick shifts—as fast as 0.2 seconds, in fact—the S tronic transmission has dual input shafts and two clutch packs that help the system “predict” the driver's acceleration or braking input, pre-select the next appropriate gear, and greatly reduce the shifting time.

¹ Always obey local speed and traffic laws. ² EPA estimates. Your mileage will vary. See www.fueleconomy.gov for details.

Control that rewards life's arbitrary impulses.



.11 - Audi MMI® Navigation Plus¹

Judge your environment, see buildings and anticipate your next turn with available 3D-navigation that helps put a little more depth in any journey.

.12 - Personal Car Setup

Your car should adjust to you, not the other way around. Experiment with a variety of settings to help you develop one-click controls and personalized settings on your A5.

.13 - SiriusXM Satellite Radio

Match your driving mood with a variety of stations throughout the nation.

.14 - Audi Music Interface

Simple to use, easy to see. The available Audi music interface allows you to enjoy a variety of playlists and stations while maintaining focus on the road.²

.15 - Telephone

Your life doesn't stop once you enter the A5. That's why we've designed an available specific hub for your compatible BLUETOOTH® mobile phone, so you can confidently interface with your A5 while keeping your eyes squarely on the road ahead.

.16 - 10 GB Audio Storage

The Audi A5 provides enough available music storage to take a cross-country trip without repeating a single song.

Pick a song. Pick a person to talk to. Pick a destination. It's your whim, delivered through the available Audi MMI Navigation plus.¹ Intuitive controls and settings allow the A5 to understand a world of commands with a simple push of a button, an easy voice command or a click of a knob, letting you focus on the drive. From SiriusXM Satellite Radio² to personalized commands, MMI helps deliver your desires. And its next-generation interface with an NVIDIA® processor allows you faster and easier access to the interactive features of MMI.



¹ Audi Navigation plus depends on signals from the worldwide Global Positioning Satellite network. The vehicle's electrical system and existing wireless and satellite technologies must be available and operating properly for the system to function. The system is designed to provide you with suggested routes in locating addresses, destinations and other points of interest. Changes in street names, construction zones, traffic flow, points of interest and other road system changes are beyond the control of Audi of America, Inc. Complete detailed mapping of lanes,

roads, streets, toll roads, highways, etc., is not possible, therefore you may encounter discrepancies between the mapping and your actual location. Please rely on your individual judgement in determining whether or not to follow a suggested Audi Navigation plus route. For mapping updates please see your Audi dealer or call 1-800-FOR-AUDI for details. ² See back cover for important information regarding required SiriusXM subscriptions.

Anticipating needs you didn't know you had.

With innovative standard active and passive safety features and an impressive variety of available driver assist features to showcase Audi progressive thinking, the A5 isn't afraid to show a prudent side. With eight standard airbags¹ (Coupe only) helping to protect the driver and passengers, and driver assistance technologies that help you stay in control, Audi thinks of your security in a comprehensive way, so you can concentrate on better things—like the great performance of your A5.

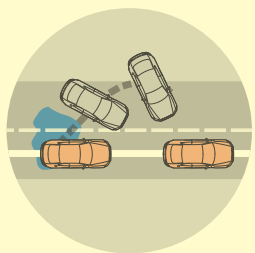

Low Traction

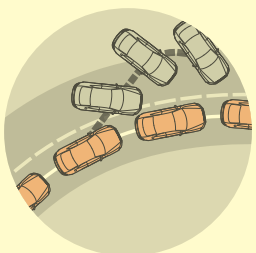

Oversteer

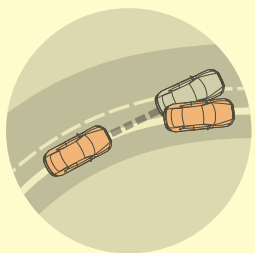

Understeer

.17 - Electronic Stability Control (ESC)

ESC is automatically applied to each wheel: at the outside front wheel to help mitigate oversteer, or the inside rear wheel to help reduce understeer. In this way, ESC helps prevent the vehicle from entering a tail-spin and reduces engine power until you regain control of the vehicle.

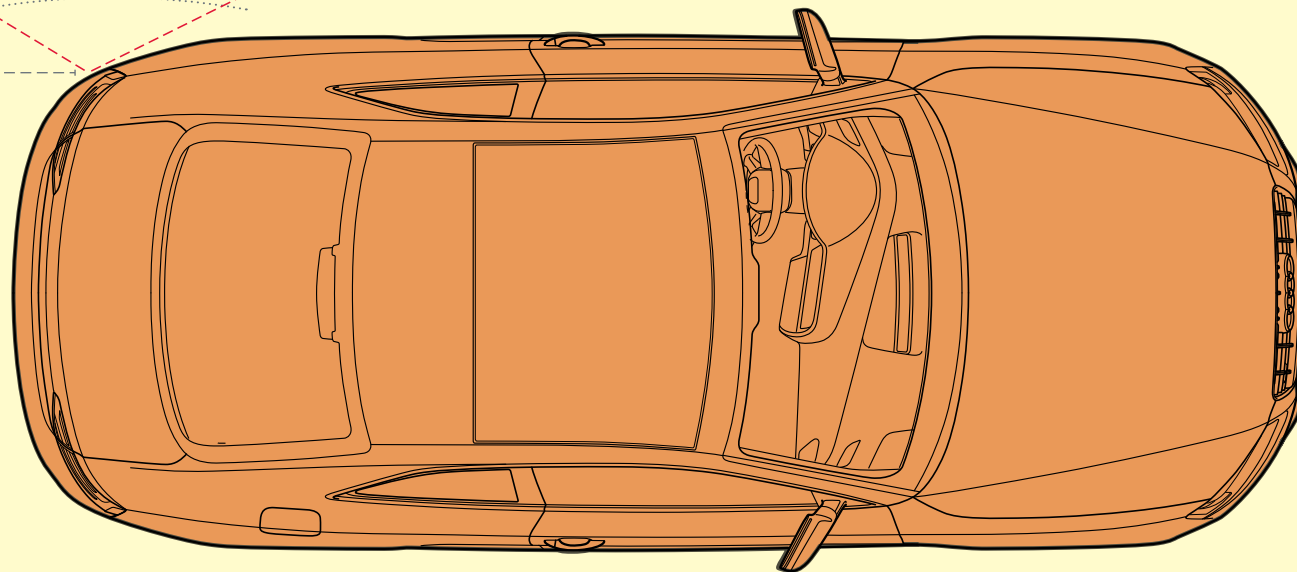
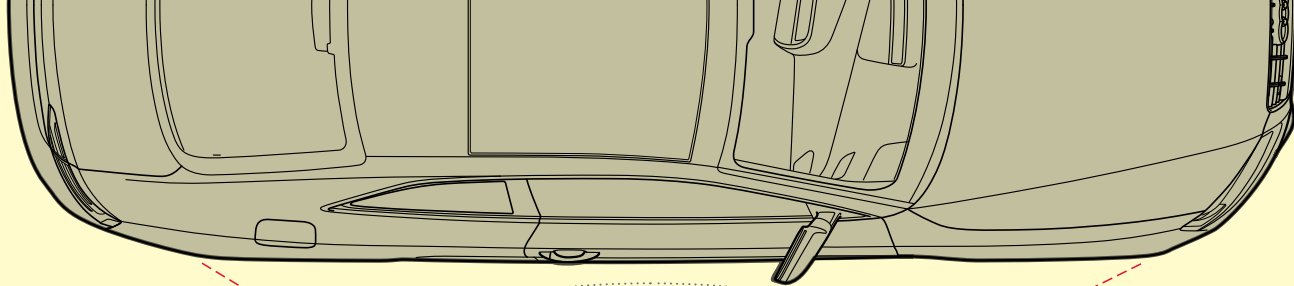

.18 - Audi Side Assist

Available radar sensors with optical warnings help keep the driver informed, in two different warning stages, about what is approaching from hard-to-see angles behind and to the side of the vehicle.



Dramatization²

.19 - Airbags

The A5 Coupe model's eight and Cabriolet model's six standard, second-generation airbags include front-impact airbags for both driver and passenger and are designed specifically to help protect the head during impact.¹

.20 - Audi Adaptive Cruise Control

Available Audi adaptive cruise control on the A5 helps the driver take command over even more of the driving experience, as its long-range radar measures the distance to the vehicle ahead, sends its data to a computer that weighs the information against velocity and other road variables, and applies the brakes as necessary. Once the road is safe to cruise, the A5 effortlessly accelerates back to its desired speed.

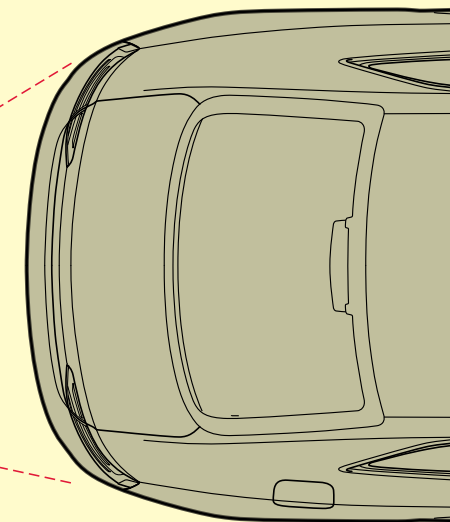

¹ Airbags are supplemental restraints only and will not deploy under all crash circumstances. Always use safety belts and seat children only in the rear, using restraint systems appropriate for their size and age. ² This is a dramatization and does not depict what will happen in a collision. All bags will not inflate in real-world collisions, and if multiple bags do deploy they will be in various stages of inflating/deflating and will never all be inflated at the same time.

Accessories

Imagine a cherry on top of your sundae. Sweet, right? Now imagine a cherry that helps protect your A5 or S5 in the garage. Or carries your bikes for a serious weekend on the trails. Or makes heads turn as you drive by. Audi Genuine Accessories are the little extras that make your Audi even sweeter. Designed by the same visionaries who designed your vehicle,

all accessories feature a tailored fit and the expert craftsmanship you'd expect from Audi. They are also backed by the 4-year/50,000-mile Audi New Vehicle Limited Warranty, or the accessory's 12-month/12,000-mile limited warranty, whichever extends longer from the accessory purchase date.¹



19" Cortada Alloy Wheels

This 19" Cortada alloy wheel offers a 5-spoke design consisting of machined triangular panels on each spoke. Its unique Cortada styling benefits from hollow spokes that help keep the A5 light and versatile.



Full Body Kit

With front and rear valances with blade inserts complementing its side skirts, the full body kit on the Audi A5 accents your personality on the open road. (Not available on S line® and S models.)

A5 All-weather Floor Mats

Deep-ribbed, channeled design helps protect the floor and carpeting from water, mud, sand and snow. Rubber mats feature vehicle logo. Set of four mats.



19" Candela Alloy Wheels

Providing an extra element of confidence to your Audi A5, this impressive drop-center, deep-dish design makes this 15-spoke wheel stand out in any environment.



Base Carrier Bars

Attached to strong side brackets, these are the durable foundation of the Audi roof-rack system. (All roof-rack system attachments require the base carrier bars. All attachments sold separately.)



Ski/Snowboard Rack

These holders and tie-downs adapt to almost any equipment shape to help you securely transport your gear to the slopes.



Rear Deck Spoiler

Body modifications aren't usually this refined. The lines of this spoiler integrate perfectly into the stock body panels of the A5 so that this enhancement meets the eye organically. The result is an inherently different look and feel to your Audi A5.

S5 All-weather Floor Mats

As a stain barrier for your S5 model's carpet, these mats withstand practically anything, from caked mud to toppled coffees and fumbled gazpacho.



S5 Cabriolet Alu-optic Kit

This set of eye-catching badges and stone guards communicate to the world the pride and passion you have for your Audi S5.



Other accessories not shown

Various Transport Solutions

The open road is calling—so bring all the right gear to enjoy the ride. The Audi line of storage accessories helps protect your possessions with a variety of intelligent and innovative solutions. Choose from bike racks, ski racks and a variety of cargo carriers.

Comfort and Protection Solutions

Audi Genuine Accessories offer a wealth of practical aids for more space, tidiness and safety on board with functional items to help keep your Audi in pristine condition. Use them all to reduce wear and tear on your Audi and help keep it looking like new—inside and out.

Car Care

Use the only car care line specifically designed with your Audi vehicle in mind. Audi Guard car care products provide gentle cleansing formulas and special tools to help give interior and exterior surfaces the finest in cleaning and protection.

License Plate Frames

Choose from "Audi Sport" in carbon fiber, black powder-coat, polished and brushed finishes, or "Truth in Engineering®" in polished and carbon fiber finishes. (Check local laws and regulations regarding use.)

Electronic Accessories

The many electronic accessories in your Audi are renowned for design that emphasizes user experience. All products are tested for compatibility with your vehicle's electrical systems so that you can easily enjoy what Audi technology has to offer.

¹ See dealer for details.

Colors

Ibis White



Glacier White metallic

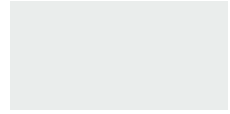

Ice Silver metallic



Monsoon Gray metallic



Estoril Blue crystal



Moonlight Blue metallic



S5 exclusive

Brilliant Black



Phantom Black pearl



Brilliant Red



Misano Red pearl¹



Teak Brown metallic



exterior

interior

Black leather or Milano leather



Cinnamon Brown Milano leather



Black leather/ Perforated Alcantara®

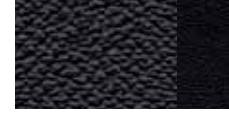

Coupe and Cabriolet

Coupe and Cabriolet

Coupe and Cabriolet

A5

Light Gray leather or Milano leather

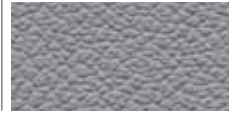

Linen Beige leather



Cardamom Beige leather or Milano leather



Coupe and Cabriolet

Coupe

Cabriolet

Black Silk Nappa or Milano leather



Tuscan Brown Silk Nappa or Milano leather



Pearl Silver Silk Nappa leather



Coupe and Cabriolet

Coupe and Cabriolet

Coupe

Magma Red Silk Nappa leather



Black leather/ Alcantara®



Black/Spectral Silver Silk Nappa leather



S5

Coupe

Coupe

Cabriolet

Black/Magma Red Silk Nappa leather



Cabriolet

Color Combinations

	Ibis White (A) (B)	Glacier White metallic (A) (B)	Ice Silver metallic (A) (C)	Monsoon Gray metallic (A) (C)	Estoril Blue crystal (A)	Moonlight Blue metallic (A)	Brilliant Black (A) (C)	Phantom Black pearl (A) (C)	Brilliant Red (A)	Misano Red pearl ¹ (A)	Teak Brown metallic (A) (B)
Black	■	■	■	■	—	■	■	■	■	■	■
Cinnamon Brown	■	■	■	■	—	■	■	■	■	■	■
Black/Perforated Alcantara®	■	■	■	■	—	■	■	■	■	■	■
Light Gray	■	■	■	■	—	■	■	■	■	■	■
Linen Beige	■	■	■	■	—	■	■	■	■	■	■
Cardamom Beige	■	■	■	■	—	■	■	■	■	■	■
Black	■	■	■	■	■	■	■	■	■	■	—
Tuscan Brown	■	■	■	■	■	■	■	■	■	■	—
Pearl Silver	■	■	■	■	■	■	■	■	■	■	—
Magma Red	■	■	■	■	■	■	■	■	■	■	—
Black/Alcantara®	■	■	■	■	■	■	■	■	■	■	—
Black/Spectral Silver	■	■	■	■	■	■	■	■	■	■	—
Black/Magma Red	■	■	■	■	■	■	■	■	■	■	—

convertible top

A. Black²



B. Brown²



C. Red²



■ Available combination — N/A

A5 Decorative Inlays

Linen Beige leather
Dark Brown Walnut Wood inlay optional

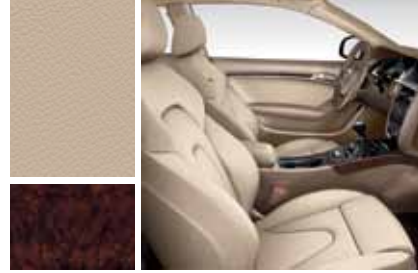

Coupe

Cinnamon Brown Milano leather
Dark Brown Walnut Wood inlay optional



Coupe and Cabriolet

Light Gray leather
Dark Brown Walnut Wood inlay optional



Coupe and Cabriolet

Black leather
Aluminum Hologram inlay standard



Coupe and Cabriolet

Black leather / Perforated Alcantara®
Brushed Aluminum inlay standard on S line®



Coupe and Cabriolet

Cardamom Beige leather
Dark Brown Walnut Wood inlay optional

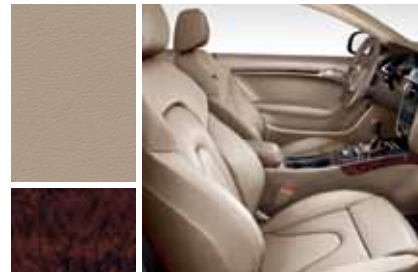

Cabriolet

S5 Decorative Inlays

Tuscan Brown Silk Nappa leather
Gray Birch Wood inlay optional



Coupe

Pearl Silver Silk Nappa leather
Brushed Aluminum inlay standard

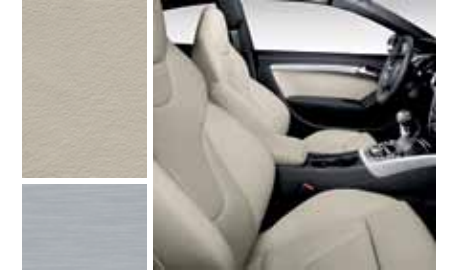

Coupe

Magma Red Silk Nappa leather
Carbon Atlas inlay optional



Coupe

Black leather / Alcantara®
Stainless Steel Mesh inlay optional



Coupe

Black Silk Nappa or Milano leather¹
Carbon Atlas inlay optional



Coupe and Cabriolet

Black / Spectral Silver Silk Nappa leather
Stainless Steel Mesh inlay optional



Cabriolet

Black / Magma Red Silk Nappa leather
Brushed Aluminum inlay standard

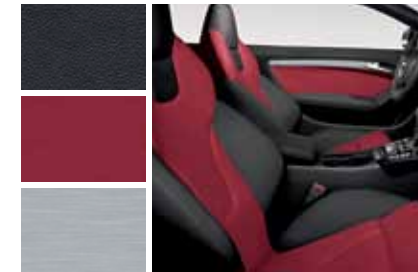

Cabriolet

Tuscan Brown Milano leather
Gray Birch Wood inlay optional



Cabriolet

Wheels

A5 | S5

18" 10-spoke-V design
245/40 all-season tires



A5 Coupe—standard

18" 15-spoke-star design
245/40 all-season tires



A5 Cabriolet—standard

18" 10-spoke design
245/40 all-season tires



Sport Package
A5 Premium Plus and Prestige—optional

19" 5-arm-Y design
255/35 summer performance tires¹



A5 Cabriolet S line® Plus Package—optional
A5 Premium Plus and Prestige—optional

19" titanium 5-arm-rotor design
255/35 summer performance tires¹



A5 Coupe S line® Plus Package—optional

19" 5-parallel-spoke-star design
255/35 summer performance tires¹



standard

19" 5-segment-spoke design
255/35 summer performance tires¹



optional

19" titanium 5-arm-rotor design
255/35 summer performance tires¹



S5 Coupe Titanium Package—optional

Configurations | Dimensions

A5 | S5 Coupe and Cabriolet Models

	Coupe					Cabriolet				
	A5 Premium	A5 Premium Plus	A5 Prestige	S5 Premium Plus	S5 Prestige	A5 Premium	A5 Premium Plus	A5 Prestige	S5 Premium Plus	S5 Prestige
2.0T with six-speed manual transmission and Audi quattro® all-wheel drive (Coupe)	■	■	■	—	—	—	—	—	—	—
2.0T with Audi multitronic® continuously variable transmission and FrontTrak® front-wheel drive (Cabriolet)	—	—	—	—	—	■	■	■	—	—
2.0T with eight-speed Tiptronic® automatic transmission and Audi quattro® all-wheel drive	□	□	□	—	—	□	□	□	—	—
3.0T with seven-speed S tronic® dual-clutch transmission and Audi quattro® all-wheel drive	—	—	—	—	—	—	—	—	■	■
4.2 FSI® with six-speed manual transmission and Audi quattro® all-wheel drive	—	—	—	■	■	—	—	—	—	—
4.2 FSI® with six-speed Tiptronic® automatic transmission and Audi quattro® all-wheel drive	—	—	—	□	□	—	—	—	—	—

A5 | S5 Coupe and Cabriolet Engine Specifications

	A5 Premium	A5 Premium Plus	A5 Prestige	S5 Premium Plus	S5 Prestige	A5 Premium	A5 Premium Plus	A5 Prestige	S5 Premium Plus	S5 Prestige
2.0-liter turbocharged: Intercooled, DOHC four-cylinder gasoline engine with Audi TFSI® direct injection, variable valve timing and valvelift system. Horsepower: 211 hp @ 4,300 rpm / Torque: 258 lb-ft @ 1,500 rpm	■	■	■	—	—	■	■	■	—	—
3.0-liter supercharged: Dual intercoolers, DOHC V6 gasoline engine with Audi TFSI® direct injection and variable valve timing. Horsepower: 333 hp @ 5,500 rpm / Torque: 325 lb-ft @ 2,900 rpm	—	—	—	—	—	—	—	—	■	■
4.2-liter: DOHC V8 gasoline engine with Audi FSI® direct injection. Horsepower: 354 hp @ 7,000 rpm / Torque: 325 lb-ft @ 3,500 rpm	—	—	—	■	■	—	—	—	—	—

A5 | S5 Coupe and Cabriolet Performance Specifications

	0 – 60 mph ²	Top Speed ² (electronically limited)
2.0T with six-speed manual transmission and Audi quattro® all-wheel drive (Coupe)	6.4 seconds	130 mph
2.0T with Audi multitronic® continuously variable transmission and FrontTrak® front-wheel drive (Cabriolet)	7.5 seconds	130 mph
2.0T with eight-speed Tiptronic® automatic transmission and Audi quattro® all-wheel drive (Coupe/Cabriolet)	6.2/6.7 seconds	130 mph
3.0T with seven-speed S tronic® dual-clutch transmission and Audi quattro® all-wheel drive (Cabriolet)	5.1 seconds	155 mph
4.2 FSI® with six-speed manual transmission and Audi quattro® all-wheel drive (Coupe)	4.9 seconds	155 mph
4.2 FSI® with six-speed Tiptronic® automatic transmission and Audi quattro® all-wheel drive (Coupe)	4.9 seconds	155 mph

Exterior Dimensions

Length: 182.1" (A5), 182.5" (S5)	A5 track, front: 62.6" A5 track, rear: 62.1"
Width: 79.5" (all models)	S5 track, front: 62.8" (Coupe), 62.5" (Cabriolet)
A5 height: 54.0" (Coupe), 54.4" (Cabriolet)	S5 track, rear: 62.2" (Coupe), 62.0" (Cabriolet)
S5 height: 53.9" (Coupe), 54.3" (Cabriolet)	Wheelbase: 108.3" (all models)

Interior Dimensions

Head room, front: 39.1" (Coupe), 40.0" (Cabriolet)	Shoulder room, front: 54.3" (Coupe), 54.3" (Cabriolet)
Head room, rear: 36.0" (Coupe), 36.3" (Cabriolet)	Shoulder room, rear: 52.8" (Coupe), 46.8" (Cabriolet)
Leg room, front: 41.3" (Coupe), 41.3" (Cabriolet)	EPA cargo volume: 12.4 cu ft (Coupe), 10.2 cu ft (Cabriolet)
Leg room, rear: 31.7" (Coupe), 31.9" (Cabriolet)	

Fuel Economy Estimates, City/Highway/Combined

A5 2.0T with manual transmission: 21/31/25	S5 3.0T with Audi S tronic® dual-clutch transmission: 17/26/20
A5 2.0T with Audi multitronic® transmission: 22/30/25	S5 4.2 with manual transmission: 14/22/17
A5 2.0T with Tiptronic® transmission: 21/29/24	S5 4.2 with Tiptronic® transmission: 16/24/19

EPA estimates. Your mileage will vary. See www.fueleconomy.gov for details.

Weights and Capacities

Curb weight: N/A	Engine oil capacity 4.2: 11.3 qt
Engine oil capacity (2.0T): 4.8 qt	Fuel tank capacity: 16.9 gal
Engine oil capacity (3.0T): 8.6 qt	

■ Standard □ Optional — N/A

¹ Tires are supplied and warranted by their manufacturer. High-performance tires are designed for optimum performance and handling in warm climates. They are not suitable for cold, snowy, or icy weather conditions. If you drive under those circumstances, you should equip your vehicle with all-season or winter tires, which offer better traction under those conditions. We suggest you use the recommended winter or all-season tire specified for your car or its equivalent. These high-performance tires also have a lower aspect ratio that aids performance and handling; however, in order to avoid tire, rim or vehicle damage, it is important that the inflation pressure is regularly checked and maintained at optimum levels. Please also remember in making your selection that, while these tires deliver responsive handling, they may ride less comfortably and make more noise than other choices. Finally, these tires may wear more quickly than other choices. ² 0–60-mph times will vary from model to model. Always obey local speed and traffic laws.

Specifications

	Coupe					Cabriolet				
	A5 Premium	A5 Premium Plus	A5 Prestige	S5 Premium Plus	S5 Prestige	A5 Premium	A5 Premium Plus	A5 Prestige	S5 Premium Plus	S5 Prestige
Chassis										
Fully galvanized steel unibody with multistep anti-corrosion protection	■	■	■	■	■	■	■	■	■	■
Five-link front suspension with upper and lower control arms with stabilizer bar	■	■	■	■	■	■	■	■	■	■
Trapezoidal-link rear suspension with stabilizer bar	■	■	■	■	■	■	■	■	■	■
Sport suspension calibration	–	□	□	–	–	–	□	□	–	–
S5 sport suspension calibration	–	–	–	■	■	–	–	–	■	■
Audi servotronic® speed-sensitive power steering—varies assistance based on vehicle speed	■	■	■	■	■	■	■	■	■	■
Dynamic steering	–	–	□	–	□	–	–	□	–	□
Audi quattro® all-wheel drive system utilizing self-locking center differential—40:60 rear-biased torque split	■	■	■	■	■				■	■
Audi quattro® with sports differential	–	–	–	□	□	–	–	–	□	□
FrontTrak® front-wheel drive	–	–	–	–	–	■	■	■	–	–
Six-speed manual transmission	■	■	■	■	■	–	–	–	–	–
Eight-speed Tiptronic® automatic transmission	□	□	□	–	–	□	□	□	–	–
Six-speed Tiptronic® automatic transmission	–	–	–	□	□	–	–	–	–	–
Seven-speed Audi S tronic® dual-clutch transmission	–	–	–	–	–	–	–	–	■	■
Audi multitronic® continuously variable transmission	–	–	–	–	–	■	■	■	–	–
Safety Security										
Driver and front passenger dual-stage airbags ¹	■	■	■	■	■	■	■	■	■	■
Driver and front passenger thorax side airbags ¹	■	■	■	■	■	–	–	–	–	–
Driver and front passenger head/thorax side airbags ¹	–	–	–	–	–	■	■	■	■	■
Sideguard® head curtain airbags ¹	■	■	■	■	■	–	–	–	–	–
Driver and front passenger knee airbags ¹	■	■	■	■	■	■	■	■	■	■
Front passenger occupant detection—for airbags	■	■	■	■	■	■	■	■	■	■
Safety belt reminder for driver and front passenger	■	■	■	■	■	■	■	■	■	■
Lower Anchors and Tethers for CHildren (LATCH) in rear seats	■	■	■	■	■	–	–	–	–	–
Lower anchors for child seats in rear seats	■	■	■	■	■	■	■	■	■	■

■ Standard □ Optional – N/A

Safety | Security (continued)

	Coupe					Cabriolet				
	A5 Premium	A5 Premium Plus	A5 Prestige	S5 Premium Plus	S5 Prestige	A5 Premium	A5 Premium Plus	A5 Prestige	S5 Premium Plus	S5 Prestige
Power central locking system with safety unlock feature if airbags deploy	■	■	■	■	■	■	■	■	■	■
Electronic Stability Control (ESC) with traction control (ASR)	■	■	■	■	■	■	■	■	■	■
Anti-lock Brake System (ABS) with Electronic Brake-pressure Distribution (EBD) and brake assist	■	■	■	■	■	■	■	■	■	■
Front ventilated disc brakes	■	■	■	■	■	■	■	■	■	■
Rear disc brakes	■	■	■	–	–	■	■	■	–	–
Rear ventilated disc brakes	–	–	–	■	■	–	–	–	■	■
Electromechanical parking brake	■	■	■	■	■	■	■	■	■	■
Infotainment Technology										
Audi MMI® Navigation plus ² with voice control system (voice control not available on Cabriolet models)	–	□	■	□	■	–	□	■	□	■
Color driver information system	–	□	■	■	■	–	□	■	□	■
Audi premium sound system with ten speakers and single CD player with MP3 playback capability	■	■	–	■	–	■	■	–	■	–
Bang & Olufsen® Sound System with 14 speakers and 505 watts (12 speakers on Cabriolet models)	–	□	■	□	■	–	□	■	□	■
HD Radio™ technology	–	□	■	□	■	–	□	■	□	■
SiriusXM Traffic with 90-day trial subscription ³	–	□	■	□	■	–	□	■	□	■
SiriusXM Satellite Radio with 90-day trial subscription ³	■	■	■	■	■	■	■	■	■	■
Audi music interface with iPod® integration	□	■	■	■	■	□	■	■	■	■
BLUETOOTH® wireless technology preparation for mobile phone	□	■	■	■	■	□	■	■	■	■
Homelink® remote transmitter	□	■	■	■	■	□	■	■	■	■
Audi advanced key—keyless start, stop and entry	–	□	■	□	■	–	□	■	□	■
Cruise control with coast, resume and accelerate features	■	■	■	■	■	■	■	■	■	■
Audi adaptive cruise control	–	–	□	–	□	–	–	□	–	□
Audi side assist	–	–	■	–	■	–	–	■	–	■
Audi drive select	–	–	□	–	□	–	–	□	–	□
Parking system with rear sensors	–	□	■	–	■	–	□	■	–	■
Rain/light sensors for automatic windshield wipers and headlights	■	■	■	■	■	■	■	■	■	■

¹ Airbags are supplemental restraints only and will not deploy under all crash circumstances. Always use safety belts and seat children only in the rear, using restraint systems appropriate for their size and age.

Specifications

	A5 Premium	A5 Premium Plus	A5 Prestige	S5 Premium Plus	S5 Prestige	A5 Premium	A5 Premium Plus	A5 Prestige	S5 Premium Plus	S5 Prestige
	Coupe					Cabriolet				
Exterior										
Audi Singleframe® grille	■	■	■	■	■	■	■	■	■	■
Halogen headlights with daytime running lights	■	-	-	-	-	■	-	-	-	-
Xenon plus headlights with LED daytime running light technology	-	■	-	■	-	-	■	-	■	-
Adaptive xenon plus headlights with LED daytime running light technology	-	-	■	-	■	-	-	■	-	■
Automatic headlights	■	■	■	■	■	■	■	■	■	■
Headlight washers	-	-	-	■	■	-	-	-	-	-
Front fog lights	■	■	■	■	■	■	■	■	■	■
LED taillight technology	-	■	■	■	■	-	■	■	■	■
Power-adjustable heated side mirrors	■	-	-	-	-	■	-	-	-	-
Power-adjustable, auto-dimming, heated side mirrors with memory (body-color on A5; aluminum optic on S5)	-	■	■	■	■	-	■	■	■	■
LED indicator light technology integrated in the side mirrors	■	■	■	■	■	■	■	■	■	■
Chrome trim around exterior windows	■	■	■	■	■	-	-	-	-	-
S quad exhaust pipes with chrome tips	-	-	-	■	■	-	-	-	■	■
Audi S line® exterior appearance	-	-	□	-	-	-	-	□	-	-
S exterior appearance	-	-	-	■	■	-	-	-	■	■

■ Standard □ Optional - N/A

1 Tires are supplied and warranted by their manufacturer. High-performance tires are designed for optimum performance and handling in warm climates. They are not suitable for cold, snowy, or icy weather conditions. If you drive under those circumstances, you should equip your vehicle with all-season or winter tires, which offer better traction under those conditions. We suggest you use the recommended winter or all-season tire specified for your car or its equivalent. These high-performance tires also have a lower aspect ratio that aids performance and handling; however,

Interior

	A5 Premium	A5 Premium Plus	A5 Prestige	S5 Premium Plus	S5 Prestige	A5 Premium	A5 Premium Plus	A5 Prestige	S5 Premium Plus	S5 Prestige
	Coupe					Cabriolet				
Interior										
Automatic climate control	■	-	-	-	-	■	-	-	-	-
Three-zone automatic climate control	-	■	■	■	■	-	■	■	■	■
Three-spoke multifunction steering wheel	■	■	■	■	■	■	■	■	■	■
Three-spoke multifunction steering wheel with shift paddles (automatic transmissions only)	-	□	□	■	■	-	□	□	■	■
Tilt and telescopic manually adjustable steering column	■	■	■	■	■	■	■	■	■	■
Leather seating surfaces	■	■	■	-	-	■	■	■	-	-
Milano leather seating surfaces and trim (perforated on Cabriolet models with ventilated seats)	□	□	□	-	-	-	□	□	□	□
Silk Nappa leather seating surfaces and trim	-	-	-	■	■	-	-	-	■	■
Leather/Alcantara® seating surfaces	-	-	□	□	□	-	-	□	-	-
Eight-way power front seats, and four-way power lumbar adjustment for driver	■	■	■	-	-	■	■	■	-	-
Twelve-way power front sport seats (includes four-way power lumbar adjustment)	-	□	□	-	-	-	□	□	-	-
Twelve-way power front S5 sport seats (includes four-way power lumbar adjustment)	-	-	-	■	■	-	-	-	■	■
Heated front seats	■	■	■	■	■	■	■	■	■	■
Ventilated front seats and head-level heating system	-	-	-	-	-	-	□	□	□	□
Driver seat memory	-	■	■	■	■	-	■	■	■	■
Split folding rear seatback	■	■	■	■	■	■	■	■	■	■
Power windows with one-touch up/down operation and pinch protection	■	■	■	■	■	■	■	■	■	■
Panoramic tilting sunroof	■	■	■	■	■	-	-	-	-	-
Acoustic folding roof—folds at speeds up to 31 mph	-	-	-	-	-	■	■	■	■	■

Packages | Options

Packages

Convenience Package: Audi music interface with iPod® integration, BLUETOOTH® wireless technology preparation for mobile phone, and Homelink® remote transmitter

Comfort Package: Perforated Milano leather seating surfaces and trim; twelve-way power front sport seats (includes four-way power lumbar adjustment); and ventilated front seats with head-level heating system

Audi MMI® Navigation Plus: Audi MMI® Navigation plus¹ with voice control system (voice control not available on Cabriolet models), color driver information system, and HD Radio™ technology

Sport Package: 18" 10-spoke design alloy wheels, sport suspension calibration, three-spoke multifunction steering wheel with shift paddles (automatic transmissions only), and twelve-way power front sport seats (includes four-way power lumbar adjustment)

S Line® Package: 19" 5-arm-Y design alloy wheels, summer performance tires², sport suspension calibration, three-spoke multifunction steering wheel with shift paddles (automatic transmission only), Brushed Aluminum inlays, and black cloth headliner

S Line® Plus Package: 19" titanium 5-arm-rotor design alloy wheels, summer performance tires², black-optic exterior appearance, S line® steering wheel emblem, leather/Alcantara® seating surfaces, Brushed Aluminum inlays, and black cloth headliner

Titanium Package: 19" titanium 5-arm-rotor design alloy wheels, summer performance tires,¹ body-color side mirrors, and black-optic exterior appearance

Drive Select Package: Dynamic steering, dynamic chassis Audi drive select (S models include sports differential)

Individual Options

19" 5-arm-Y design alloy wheels with summer performance tires ²	-	□	□	-	-	-	□	□	-	-
19" 5-segment-spoke design alloy wheels with summer performance tires ²	-	-	-	□	□	-	-	-	□	□
Bang & Olufsen® Sound System with 14 speakers and 505 watts (12 speakers on Cabriolet models)	-	□	■	□	■	-	□	■	□	■
Audi advanced key—keyless start, stop and entry	-	□	■	□	■	-	□	■	□	■
Audi adaptive cruise control	-	-	□	-	□	-	-	□	-	□
Cinnamon Brown Milano leather seating surfaces and trim	□	□	□	-	-	□	□	□	-	-
Leather/Alcantara® seating surfaces	-	-	-	-	-	-	-	-	-	-
Heated front seats	□	■	■	■	■	□	■	■	■	■
Dark Walnut Wood inlays	□	□	□	-	-	□	□	□	-	-
Gray Birch Wood inlays	-	-	-	□	□	-	-	-	□	□
Stainless Steel Mesh inlays	-	-	-	□	□	-	-	-	□	□
Carbon Atlas inlays	-	-	-	□	□	-	-	-	□	□
Power rear sunshade	-	-	□	-	□	-	-	-	-	-
Sports differential	-	-	-	□	□	-	-	-	□	□

in order to avoid tire, rim or vehicle damage, it is important that the inflation pressure is regularly checked and maintained at optimum levels. Please also remember in making your selection that, while these tires deliver responsive handling, they may ride less comfortably and make more noise than other choices. Finally, these tires may wear more quickly than other choices.

2012 | A5 S5

Audi of America
Audiusa.com
Facebook.com/Audi

Note: A word about this brochure. Audi of America, Inc., believes the specifications in this brochure to be correct at the time of printing. However, specifications, standard equipment, options, fabrics, and colors are subject to change without notice. Some equipment may be unavailable when your vehicle is built. Please ask your dealer for advice concerning current availability of standard and optional equipment, and your dealer will verify that your vehicle will include the equipment you ordered. Vehicles in this brochure are shown with optional equipment. See your dealer for complete details on the New Vehicle Limited Warranty, twelve-year limited warranty against corrosion perforation, and Audi 24/7 Roadside Assistance. (Roadside assistance coverage provided by Road America in the U.S. Certain conditions apply; see your dealer for details.) Tires supplied by various manufacturers. "Audi," all model names, "Front-Trak," "FSI," "MMI," "multitronic," "quattro," "Sideguard," "Singleframe" and the Singleframe grille design, "S line," "S tronic," "TFSI," "Truth in Engineering," and the four rings logo are registered trademarks of AUDI AG. "Alcantara" is a registered trademark of Alcantara S.p.A. "Bang & Olufsen" is a registered trademark of Bang & Olufsen. The BLUETOOTH word mark and logos are owned by the Bluetooth SIG, Inc., and use of any such marks by AUDI AG is under license. "HD Radio" and the HD Radio logo are proprietary trademarks of iBiquity Digital Corporation. "Homelink" is a registered trademark of Johnson Controls Technology Company. "iPod" is a registered trademark of Apple, Inc. "NVIDIA" is a registered trademark of NVIDIA Corporation. "Servotronic" is a registered trademark of the AM General Corporation. "Sirius" and all related marks and logos are trademarks of SiriusXM Radio Inc. and its subsidiaries. SiriusXM Satellite Radio and Traffic subscriptions sold separately or as a package after trial expires. SiriusXM Traffic service available in select markets. Subscriptions are governed by SiriusXM Customer Agreement (see www.siriusxm.com) and are continuous until you call SiriusXM to cancel. Sirius U.S. Satellite Service available only to those 18 and older in the 48 contiguous U.S.A., D.C. and Puerto Rico (with coverage limitations). "Tiptronic" is a registered trademark of Dr. Ing h.c. F. Porsche AG. All other trademarks are the property of their respective owners. Some European models shown.