

2011 BMW  
1 Series Coupe



128i  
135i

The Ultimate  
Driving Machine®



# THE BMW 1 SERIES COUPE.

JOY IS THE EMOTION OF MOTION.

BMW EfficientDynamics  
Less emissions. More driving pleasure.



**2011 BMW 1 Series Coupe**

- 0417 Exterior
- 18123 Interior

**Technology**

- 24125 BMW EfficientDynamics
- 26127 Engine
- 28129 7-Speed Double Clutch Transmission (DCT)
- 30131 Suspension and handling
- 32135 Safety
- 36137 BMW ConnectedDrive

**Features**

- 38141 Paints | Upholsteries | Interior trims | Combinations
- 42145 Selection examples
- 46155 Standard | Optional equipment
- 56 Safety illustrations
- 57161 Standard | Optional equipment charts
- 62163 Technical data
- 64165 BMW Services
- 66 BMW Accessories

It's been more than 40 years since the 2002 first arrived in the U.S. and launched the sports sedan concept. Now BMW brings the true essence of driving enjoyment to a new level for today's enthusiasts. The 1 Series Coupe: a dynamic four-seater with clean, sporty lines, a classic interior, and a joyful passion for performance. How do you like your fun? BMW lets you create your own 1 Series, with a choice of two powerful and fuel-efficient six-cylinder engines; 6-speed manual and STEPTRONIC automatic transmissions and a 7-speed Double Clutch Transmission; and dozens of ways to express your personality through distinctive paints, upholstery and optional features. No matter how you design it, your BMW 1 Series personifies the ultimate driving experience.



135i Coupe shown with the following equipment:

- Engine: 24-valve, TwinPower Turbo, 3.0-liter, inline six-cylinder
- Wheels: Star Spoke (Style 264) light alloy
- Exterior color: Sedona Red Metallic
- Upholstery: Black Boston Leather
- Interior trim: Glacier Silver Aluminum

**BMW 135i Coupe**

For details on Standard and Optional equipment, please refer to Equipment Section pages 46-61.



**WELCOME TO THE 1 SERIES:  
A CELEBRATION OF THE SPIRIT OF BMW.**

BMW EfficientDynamics   
Less emissions. More driving pleasure.

## THE FASTEST ROUTE TO A GRIN.

The 1 Series Coupe was created for pure driving exhilaration. Unleash the eager 230-hp inline six-cylinder engine in the 128i and feel the exhilaration of racing from 0 to 60 in 6.1 seconds.<sup>1</sup> In the 135i, a 300-hp TwinPower Turbo inline six generates 300 lb-ft of torque to slingshot the Coupe past 60 mph in just 5.0 seconds.<sup>2</sup> It takes tight corners with minimal roll, courtesy of a special sport suspension. And its lean, muscular body, accentuated by its aerodynamic kit, improves handling. A trunklid spoiler, for example, helps keep the 135i's 18" wheels and run-flat performance tires<sup>3</sup> glued to the road by reducing lift in the rear at high speeds. All the while, fade-resistant, high-performance anti-lock brakes with six-piston callipers in front and two-piston at the rear help keep all this forward momentum in check. When you drive the 1 Series Coupe, you're guaranteed to come away grinning.



<sup>1</sup> Manual transmission; 6.7 seconds, STEPTRONIC automatic. BMW AG test results. BMW urges you to obey all posted speed laws and always wear safety belts.

<sup>2</sup> 7-speed Double Clutch Transmission (DCT); 5.1 seconds, manual. BMW AG test results. BMW urges you to obey all posted speed laws and always wear safety belts.

<sup>3</sup> Performance tires are not recommended for driving in snow and ice. Due to low-profile tires, please note: wheels, tires and suspension parts are more susceptible to road hazard and consequential damages.



**DESIGNED TO DELIGHT, MILE AFTER MILE.**

The BMW 1 Series Coupe melds classic BMW design elements with notable performance touches. Four dazzling light alloy wheel styles complement the powerful silhouette. A long hood, distinctive shoulder line, short overhangs and trunklid spoiler underscore its sporty attitude. Just as impressive as its looks is its ability to deliver peace of mind with BMW Ultimate Service,<sup>1</sup> the industry-leading, no-cost maintenance plan that covers virtually every wear-and-tear item, like brake pads and rotors, for four years or 50,000 miles, whichever comes first.<sup>1</sup> It's just another innovative BMW idea – one designed to maintain your driving pleasure for many miles to come.

<sup>1</sup> Please visit [bmwusa.com/ultimateservice](http://bmwusa.com/ultimateservice) for complete details.

## YOU AND THE ROAD. ONE.

Only BMW could endow the 1 Series with the precise engineering and performance innovations worthy of "The Ultimate Driving Machine.<sup>®</sup>" It starts with classic BMW rear-wheel drive and near-perfect 50/50 weight distribution for balanced handling when accelerating and braking on straightaways and in turns. An aluminum double-pivot front suspension, and a five-link, fully independent rear suspension made of lightweight steel further hone its lightning-quick responsiveness. Even in the most slippery conditions, BMW's Dynamic Stability Control (DSC) helps keep the 1 Series Coupe stable and going in your intended direction. Optional Active Steering automatically adjusts your steering ratio based on vehicle speed, for more immediate control at low to medium speeds, and more stability at highway speeds. The BMW 1 Series Coupe: born to perform.

For details on the availability of standard and optional features, please refer to the Standard equipment | Optional equipment charts at the back of this brochure.





**A STUNNING REFLECTION OF  
ADVANCED AUTOMOTIVE DESIGN.**



## YOU CAN IMMEDIATELY SEE SOME OF THE BRIGHT IDEAS THAT WENT INTO THE 1 SERIES COUPE.

Look into its eyes – the Corona headlight-rings that function as parking lights and identify the 1 Series Coupe as a BMW. They circle the Xenon Adaptive Headlights that turn night into day with brilliant illumination, and swivel to show what's around the corner as you turn. Flick the right-hand turn signal, and Cornering Lights flood a large swath to your right, revealing previously unseen obstacles, animals or pedestrians. Daytime running lights can be activated at your BMW center or with optional iDrive; when sensors detect fading ambient light, BMW's Automatic headlight control function automatically turns the headlights on. From the rear, the 1 Series Coupe is equally arresting. During emergency stops, the normally bright LED taillight clusters and brake display are intensified for an immediate warning to those behind you.

For details on the availability of standard and optional features, please refer to the Standard equipment | Optional equipment charts at the back of this brochure.



**EVERY BEND IS AN OPPORTUNITY  
TO REDISCOVER THE JOY OF DRIVING.**

The more sinuous the road, the greater the reward of driving the 1 Series Coupe. This is where the value of a BMW's rear-wheel drive and near-perfect 50/50 weight distribution, extremely rigid body and precise steering come into play. Curving roads, steep hills and wet weather conditions set the stage for BMW's Dynamic Stability Control (DSC) system to shine. In addition to limiting wheelspin and delivering road-gripping traction, DSC also helps counteract the effects of wet and overheated brakes. The fleeting appearance of the DSC light on the dash lets you know it's busy at work – otherwise, you'd be totally unaware that any of this is happening. All you experience is sheer driving joy.



It's difficult to take in the dynamic beauty of the 1 Series Coupe at a single glance. There's the power of its aerodynamic silhouette and athletic stance. The fluid motion of its lines and contours. The way the compact body blends into the long front hood, creating the impression of irresistible forward motion. And the unmistakable design elements, such as the twin-kidney grille, signature Hofmeister kink, striking shoulder line and short overhangs, that say "pure BMW."

**A SCENIC WONDER.**





## THE 1 SERIES AWAITS YOUR COMMAND.

Whatever your point of view, the BMW 1 Series is a treat for the eyes. Inside the driver-oriented cockpit, gauges and controls – accented with the glow of galvanized pearl gloss trim – are strategically positioned for intuitive sight and reach. All driving functions are easily accessed by controls arrayed around the three-spoke leather-wrapped multi-function sport steering wheel. The Navigation system with iDrive includes six programmable memory buttons to quickly access your most frequently used functions. The 1 Series Coupe interior creates a wonderful environment to enjoy your favorite music. You can plug your MP3 player into the Auxiliary input or, with the iPod® and USB adapter, access songs, playlists – even your iPhone™ – all from the steering wheel. BMW also lets you experience the finest in sound with HD Radio™ SIRIUS Satellite Radio, and a Harman Kardon Surround Sound Audio System.

For details on the availability of standard and optional features, please refer to the **Standard equipment** | **Optional equipment** charts at the back of this brochure.



## GET IN – AND GET WITH IT.

From the two-way glass moonroof above to the plush carpeting below, everything in the 1 Series Coupe thoroughly embodies BMW style, comfort and luxury. The eight-way adjustable front seats with two-way headrests can be enhanced with a host of optional features, including power adjustment with four-way lumbar support; elegant Boston Leather upholstery; and a choice of genuine wood or aluminum interior trims. The optional Sport Package adds eight-way front sport seats with adjustable side bolsters to hold you tight in curves. Convenient storage abounds: the center console offers a variety of storage spaces, while integrated map compartments are housed in the lower part of the doors. And the greatest luxury of all, roadgoing confidence, is yours, courtesy of BMW's passive safety features, including the front and rear Head Protection System (HPS) and front-seat-mounted side-impact airbags.

For details on the availability of standard and optional features, please refer to the Standard equipment | Optional equipment charts at the back of this brochure.



## THE ONLY PLACE WHERE FUN TAKES A BACK SEAT.

Even your back-seat passengers can enjoy the spirited performance of the 1 Series Coupe. The front seats are designed to allow easy entry and exit from the rear cabin. The two ergonomically engineered, 60/40 split rear seats are as practical as they are relaxing: when you need more cargo-carrying space, the seats can be folded forward individually to extend the trunk area. Passengers will also appreciate the convenient storage bin, the comfortable headrests, and the added reassurance of the Head Protection System.

## THIS IS HOW MUCH HAS GONE IN.

At BMW, we create dynamic vehicles that thrill you with quick acceleration, predictable handling and unshakable control. We are also busy finding innovative fuels and technologies that help preserve the environment while delivering legendary performance. This is what we refer to as "EfficientDynamics." This goal led to the visionary CleanEnergy hydrogen-powered engine in the BMW Hydrogen 7 Sedan. In 2009, BMW introduced Advanced Diesel with BluePerformance in the U.S., offering diesel power with quick acceleration, increased fuel efficiency and reduced emissions. And now, BMW's ActiveHybrid X6 and ActiveHybrid 7 vehicles combine combustion and electric power to boost performance while simultaneously reducing fuel consumption and CO<sub>2</sub> emissions. At BMW, we are driven to do much more with less.

### Double-VANOS

VANOS is BMW's valve timing system that can "steplessly" vary the points in the combustion cycle when valves open and close. Double-VANOS refers to the fact that it operates on both the intake and exhaust camshafts. Electronically controlled in response to engine speed, load and temperature, VANOS reduces emissions, and enhances low- to medium-speed torque, as well as fuel efficiency.

### Aerodynamics

The more smoothly that air flows over a vehicle, the more efficiently it can operate. All BMWs are designed for a low coefficient of aerodynamic drag, which translates into quicker acceleration, more stable handling, quieter operation and greater fuel efficiency. A BMW's integrated front spoilers reduce the amount of air flowing underneath, minimizing front-end lift. This allows a BMW to hug the road at higher speeds for excellent stability.

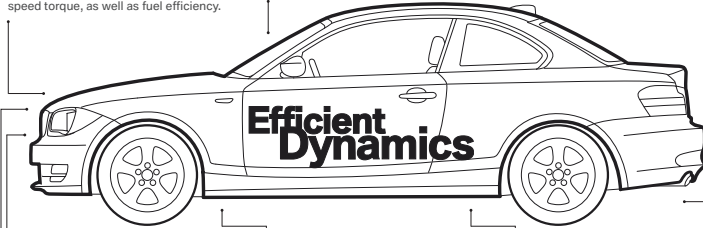

### Valvetronic

Instead of using a traditional throttle, Valvetronic technology lets the engine breathe more easily by varying the lift height of the valves to regulate air intake. The result: improved cold starts, smoother running, and a significant drop in fuel consumption. Using revolutionary technology such as this, BMW has improved its overall average fuel economy more than any other manufacturer.

### Efficient transmissions

The 1 Series Coupe offers a choice of transmissions, each designed to maximize efficiency. In both models, a smooth-shifting 6-speed manual is standard. Automatic transmissions are also available: a 6-speed STEPTRONIC automatic in the 128i, and in the 135i, a quick-shifting 7-speed Double Clutch Transmission.

### Lightweight construction

Our engineers use lightweight aluminum throughout our vehicles – in the front section, for example, or for the suspension. BMW's inline six-cylinder TwinPower Turbo engine is all aluminum; the naturally aspirated inline six is an aluminum/magnesium composite – the lightest in its class. Taken together, these weight savings lead to lower fuel consumption and better axle load distribution for more agility – especially in curves.

### TwinPower Turbocharged engine

The 300-hp 135i benefits from BMW's new TwinPower Turbo engine with Valvetronic technology that delivers quick acceleration without any "turbo lag." Fuel economy is strong, as well, thanks to High Precision Injection.

## AND THIS IS WHAT COMES OUT.

BMW models have low CO<sub>2</sub> emissions today. But that's just for starters. We're carrying on our research in the quest to bring you greater driving pleasure, with fewer emissions and decreased fuel consumption.

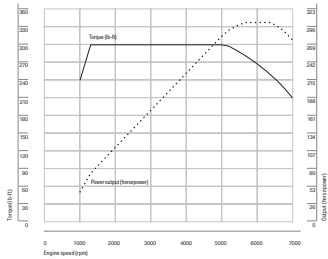

**Portrait of an engineering masterpiece:** The 135i TwinPower Turbo engine produces 300 hp at 5800 rpm, and quickly develops 300 lb-ft of torque at just 1200 rpm, which continues, without fading, to the 5000 rpm range. With such a broad range of powerful torque, you can enjoy smooth, robust acceleration in any gear, at any speed.

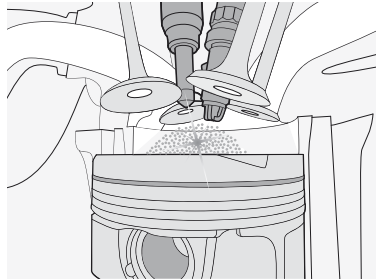

**High Precision Injection:** Piezo injectors positioned close to the spark plugs in the 135i ensure lean-burn operation under partial loads. To provide optimum combustion, the fuel is injected at high pressure into the cylinders, up to 200 times per fraction of a second. This means that only part of the combustion chamber is filled with an ignitable fuel/air mixture, so fuel is used extremely efficiently.



## BMW'S REVOLUTION IN POWER TURBOCHARGES YOUR FUN.

BMW engines deliver power and performance with unsurpassed smoothness and efficiency. Small wonder they have been winning accolades and awards from the automotive press for years.

The 135i for 2011 draws upon BMW's new TwinPower Turbo – the first engine in the world to combine turbocharging, High Precision Injection and Valvetronic technology. This twin-scroll wonder develops 300 lb-ft of torque at just 1200 rpm and continues all the way to 5000 rpm. It's a force that throws you back in your seat right from the start and doesn't let up. With 300 horses on tap, the 135i can sprint from 0 to 60 mph in 5.0 seconds.<sup>1</sup> Thanks to BMW's award-winning engine expertise, turbo lag is virtually a thing of the past. By using High Precision Injection, every ounce of fuel is maximized for greater efficiency, with reduced CO<sub>2</sub> emissions.

The naturally aspirated, 230-hp inline six in the 128i is capable of producing 200 lb-ft of torque at 2750 rpm, for power that pours on early and strong and continues throughout the powerband. Hit the accelerator and you're sailing past 60 mph in 6.1 seconds.<sup>2</sup> BMW's advanced Valvetronic

technology lets the engine "breathe" better, for greater power, higher torque, quicker engine response, a smoother idle and enhanced fuel efficiency. The lightweight composite magnesium/aluminum engine block adds to the 128i's spirited acceleration and nimble handling.

Both models offer, as standard, a silky-shifting 6-speed manual. The 135i can also be ordered with a 7-speed Double Clutch Transmission (DCT) for lightning-quick shifts; in the 128i, STEPTRONIC automatic with Adaptive Transmission Control is available. When either model is equipped with the optional transmission – and, in the 128i, either the Sport Package or M Sport Package – steering wheel-mounted paddle shifters are automatically added. But whichever engine and transmission combination you choose, innovative BMW engineering makes it possible to enjoy outstanding power and performance with reduced emissions and fewer trips to the pump.

**BMW's TwinPower Turbo technology in the 135i delivers immediate power and torque, as well as increased fuel efficiency and reduced emissions.**

<sup>1</sup> 7-speed Double Clutch Transmission; 5.1 seconds, manual. BMW AG test results. BMW urges you to obey all posted speed laws and always wear safety belts.

<sup>2</sup> Manual transmission; 6.7 seconds, STEPTRONIC automatic. BMW AG test results. BMW urges you to obey all posted speed laws and always wear safety belts.

## DOUBLE CLUTCH TRANSMISSION: INSTANTANEOUSLY TRANSLATING POWER INTO PERFORMANCE.

All the horsepower in the world is useless – unless it can be quickly, smoothly and efficiently transferred to the road. The BMW 135i Coupe's 300 horsepower is put to work with eye-opening speed via the optional 7-speed Double Clutch Transmission (DCT). With this technology, first, third, fifth and seventh gears are grouped in one structure; second, fourth and sixth gears are grouped in the other. When upshifting or downshifting, the system switches between the two structures, so that while one gear is being disengaged, the next is already in position. Gear changes are made within a few milliseconds and without loss of drive power, for exhilarating acceleration. In automatic mode, the 135i's fast, precise selection of the most efficient gear helps reduce fuel consumption, while the almost imperceptible change from one gear to the next

significantly enhances comfort. And if a hands-on approach to switching gears is your preference, the steering wheel-mounted paddle shifters enable you to simultaneously keep both hands on the wheel as you up- or down-shift in manual mode without the use of a clutch.

In both automatic and manual mode, you can press the Sports button for an even more dynamic gearshift response. Using the Sports button also changes the accelerator and engine response, allowing the engine to rev higher before the transmission changes to the next gear – a feature that is particularly thrilling in manual mode. Here, too, the transmission electronics provide added assistance, adjusting the engine speed to match the selected gear when downshifting.

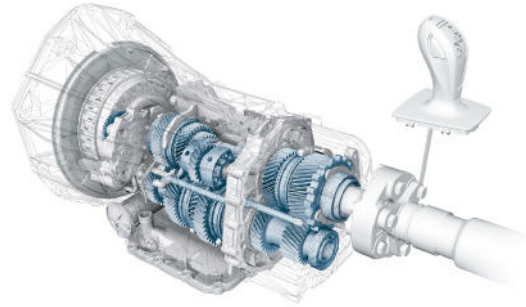

The 7-speed Double Clutch Transmission divides the seven forward gears into two structures. When one gear is reaching optimal rpm, the next higher gear is positioned for a split-second spring into action.





## ACTIVE STEERING: FOR THE PERFECT BLEND OF STABILITY AND AGILITY, WITH FLUID PERFORMANCE AT HIGHER SPEEDS.

BMW engineered the 1 Series Coupe's lightweight chassis to perfectly harmonize with the engine and transmission. So as soon as you start driving, you're aware of how well it reacts to the road – with precise steering, agile handling and lack of vibration and noise.

Further enhancing the quality of the driving experience, BMW offers optional Active Steering in the 135i – an innovative option that adapts the steering ratio and front-wheel turn-angle to suit the vehicle's speed. At low speeds, it takes just two turns of the steering wheel to move the front wheels from far left to far right, providing greater agility on winding roads and improved ease when parking. As the vehicle speed increases, the steering ratio gradually changes; at highway speeds, you enjoy greater directional stability and more comfortable cruising. The result: intuitive steering feel at all speeds.

Active Steering also includes yaw compensation, an "active safety" benefit that helps to keep the vehicle going straight while braking on surfaces where each wheel has varying levels of grip. For example, if the car begins to swerve while braking, Active Steering compensates by means of automatic, subtle steering adjustments.

When you combine the benefits of Active Steering with the 135i Coupe's powerful acceleration, neutral steering and excellent road holding, it adds up to an intensely enjoyable driving experience.

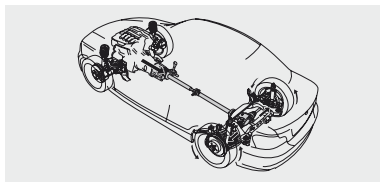

**Rear-wheel drive:** The hallmark BMW rear-wheel-drive configuration gives the 1 Series Coupe an athletic agility, while helping to maintain an even weight distribution across the entire drive system. The result is optimized traction and transmission of power to the road.

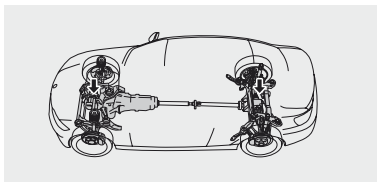

**Near-perfect 50/50 weight distribution:** The front and rear axles each carry almost exactly half of the car's weight. Balanced weight gives the 1 Series Coupe neutral steering and outstanding directional stability. And with a sport-tuned suspension and DSC provided as standard, it remains stable in virtually all road conditions.

For details on the availability of standard and optional features, please refer to the Standard equipment | Optional equipment charts at the back of this brochure.

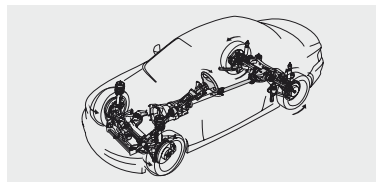

**Steering:** Torque steer is eliminated in the 1 Series because steering and propulsion are not handled by the same pair of wheels. Steering force is evenly distributed; steering does not become harder, and steering-wheel angles are small. An added benefit: increased cornering speed.

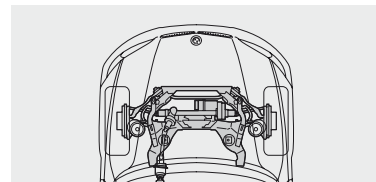

**Aluminum front suspension:** The 1 Series Coupe uses a lightweight, twin-joint tension strut suspension for maximum strength and minimum weight; hydro-mounts reduce vibration and noise. The overall result is noticeably athletic agility and responsive steering.



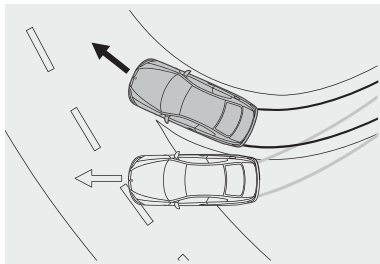

**Dynamic Stability Control (DSC)** helps to stabilize a BMW in just milliseconds when it senses an impending skid. If the system senses over- or understeer, it modulates engine power and can apply brakes individually to help keep the vehicle under control and going in the intended direction. For sportier driving or in deep snow, **Dynamic Traction Control (DTC)** allows increased wheelslip. In the 135i Coupe, DSC is designed specifically for performance-oriented driving. The accelerator pedal has a quicker response rate; the electronic rear brakes simulate a different differential lock for stronger acceleration in turns.

## A DYNAMIC “ACTIVE SAFETY” DUO: POWERFUL BRAKES AND DSC.

Even more important than quick acceleration, a BMW's large, fade-resistant brakes are a crucial part of its active safety capabilities. That's why the 1 Series Coupe is equipped with four potent, ventilated anti-lock disc brakes. These work together with BMW's Dynamic Stability Control (DSC) system to create a formidable active safety system to help keep you in control at all times.

In addition to Dynamic Brake Control, Cornering Brake Control and All Season Traction, DSC also includes four inspired brake function enhancements. When a sensor detects that it is raining, **Brake Drying** works to eliminate accumulated moisture by bringing the brake pads into contact with the rotors to help dry them. If you suddenly remove your foot from the throttle, **Brake Stand-by** anticipates you want to stop quickly, and pre-tenses the brake calipers for faster action when you apply the brakes. When descending steep roads, brakes can heat up from continuous and repeated braking; this reduces braking power. **Brake Fade Compensation** senses and compensates for this by applying the brakes with more force, while using the same pedal pressure. **Start-off Assistant** helps prevent your car from rolling forwards or backwards when stopped on a hill, holding it momentarily as you release the brake to start moving again.

It all adds up to a greater sense of driving security – and pleasure.



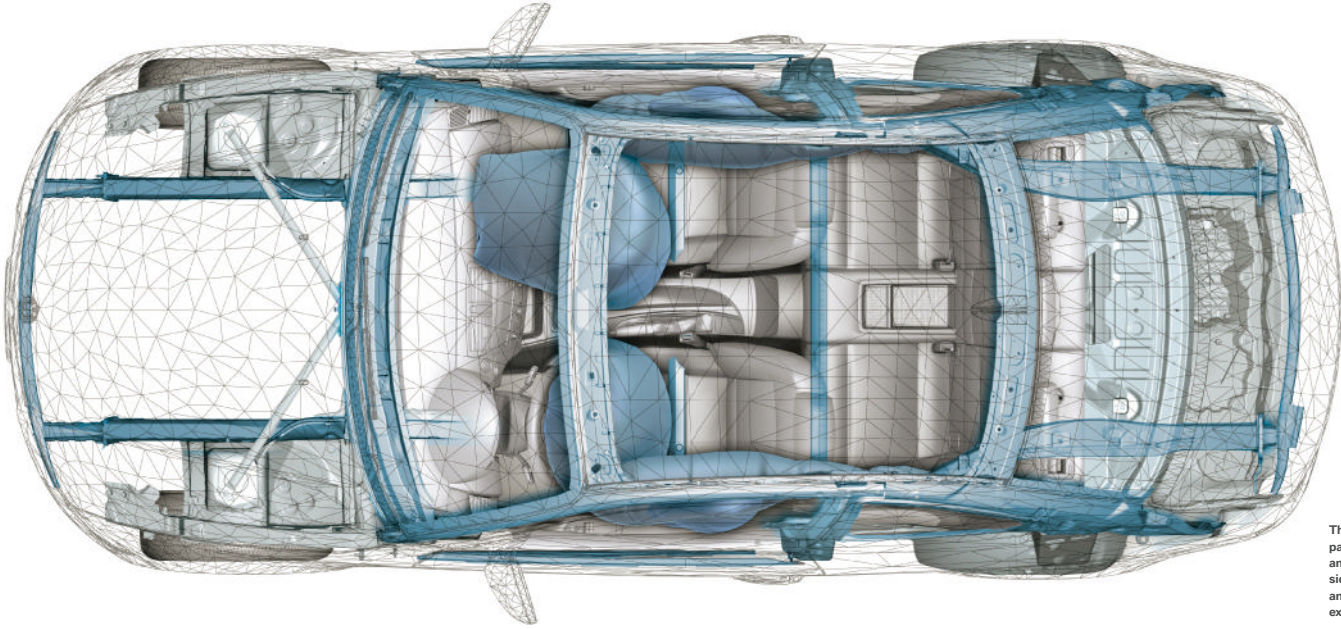

The 1 Series Coupe's extremely stiff passenger cell, safety-belt system, driver and front passenger airbags at front and sides, and Head Protection System front and rear work together to help provide excellent protection in an impact.

Please note: These pictures of airbags are for illustrative purposes only. Depending upon the type of accident, none, some or all airbags may deploy.

## SAFETY IS ALWAYS NUMBER ONE IN THE 1 SERIES.

Not all collisions can be avoided. That's why every BMW is designed to help minimize the impact on you, your passengers, and those around you. The 1 Series Coupe's protection starts with its extremely rigid body. At speeds up to nine mph, impacts are absorbed by bumpers and compressible crush tubes front and rear. At higher speeds, the body is designed to deform in a predetermined pattern, routing impact energy around the passenger cell.

The 1 Series is also equipped with BMW's Advanced Safety System. During a crash, various sensors assess the situation and determine the best deployment strategy for safety restraints throughout the

vehicle, such as safety-belt pretensioners and front- and side-impact airbags. During side-impact collisions, BMW's award-winning Head Protection System (HPS) helps cushion front and rear occupants' heads, shielding them from debris. After any serious accident, a BMW's hazard lights flash, the interior lights come on, and the doors unlock to allow access for emergency assistance. And a BMW model equipped with BMW Assist™<sup>1</sup> will automatically transmit its location to a response specialist, who will coordinate any needed emergency help, for your added peace of mind.

<sup>1</sup> For details on BMW Assist Safety and Convenience Services, visit [bmwassist.com](http://bmwassist.com).

When an upcoming service need is detected, your BMW automatically transmits the relevant information to your BMW Service Advisor, who then contacts you to arrange an appointment.

Select not only the fastest, but also the more interesting roads to reach your destination.

Heading for a traffic jam?  
**Real Time Traffic Information** lets you know in advance – and recommends an alternate route.

Get into a serious accident?  
Your BMW automatically calls for help and communicates the relevant information.

All drivers sometimes need to stop and refuel. Let a **BMW Assist** Concierge locate and send the address of your preferred gas station and the best local restaurant to your BMW.

Need an address or telephone number? **BMW Search** uses Google Maps™ to find them, then your Navigation system guides you there.

Find many more ways how **BMW Assist** makes every trip you take more enjoyable.



**MyInfo** allows you to send business locations and street addresses to your BMW from Google Maps. Destinations and phone numbers can be accessed and exported to your Navigation system for immediate route guidance, while you can call the destination with your Bluetooth® linked phone.

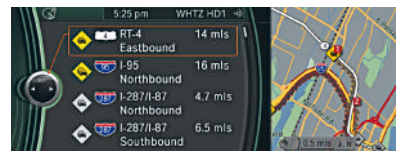

In most large cities, **Real Time Traffic Information** makes you aware of traffic congestion before you encounter it. This feature displays and describes current local traffic information on your control display; in case of delays greater than five minutes, it suggests alternate routes.

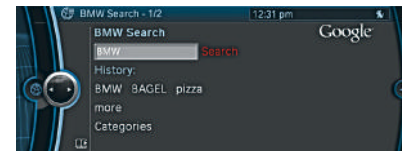

**BMW Search™** allows online access to up-to-date fuel prices, the latest weather forecasts, Bloomberg stock indices and the powerful reach of the Google Maps database – delivered on your control display inside your vehicle.

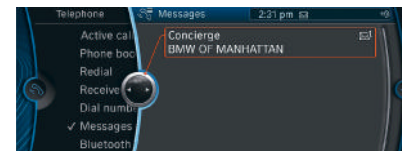

Want to know the location of a challenging golf course or a fine French restaurant? Talk to our **Concierge** and get the address and phone number of your desired destination sent to your BMW Navigation system and then start route guidance at the push of a button.

## TWO FOR THE ROAD: NAVIGATION AND BMW ASSIST.™



When you're far from home – or just in the next town – it's easy to find your way with confidence and peace of mind with the convenient features and services available on your BMW. Vehicles equipped with BMW Assist come with four years of a wide range of services at no additional charge.

**BMW Assist Safety Plan** gives you peace of mind knowing that a friendly response specialist is there to help you 24/7, at the touch of a button. The Safety Plan includes Automatic Collision Notification, Emergency Request (SOS), TeleService, Enhanced Roadside Assistance, Door Unlock, Stolen Vehicle Recovery, Customer Relations and MyInfo.

The **BMW Assist Convenience Plan** adds operator-assisted Directions, Traffic and Weather reports, BMW Search and Concierge services to not only recommend restaurants and hotels, but then also send the destination address and phone number right to your BMW. You can make up to four Critical Calls if your cell phone is not available or its battery is discharged.

For details on the availability of standard and optional features, please refer to the Standard equipment / Optional equipment charts at the back of this brochure.

The pages in this section show available colors and materials for the BMW 1 Series Coupe. Use these samples to compare paint, upholstery, trim colors and combinations. Please note that these samples are representations; they are not exact reproductions. To see the actual colors, visit your local BMW center. They will be happy to show you original samples and assist you with special requests.

### Exterior colors

■ 300 Alpine White Non-metallic

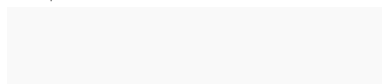

■ A61 Crimson Red Non-metallic<sup>1</sup>



■ 668 Jet Black Non-metallic<sup>1</sup>



□ 354 Titanium Silver Metallic



□ A72 Cashmere Silver Metallic<sup>1</sup>



□ 896 Blue Water Metallic<sup>1</sup>



□ A51 Montego Blue Metallic<sup>1</sup>



□ A76 Deep Sea Blue Metallic<sup>1</sup>



□ 381 Le Mans Blue Metallic<sup>2</sup>



□ A52 Space Gray Metallic



□ A79 Sedona Red Metallic



□ 475 Black Sapphire Metallic



### Upholstery colors

■ KAA5 Taupe Leatherette



■ KASW Black Leatherette



□ LWB4 Savanna Beige/Black Boston Leather

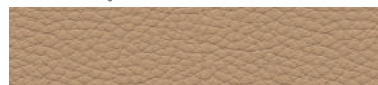

□ LWA5 Taupe Boston Leather

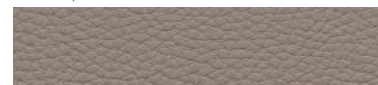

□ LWAL Gray Boston Leather

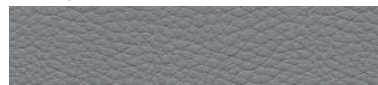

□ LWD1 Coral Red Boston Leather

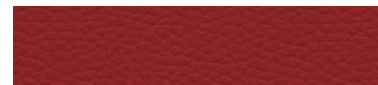

□ LWSW Black Boston Leather

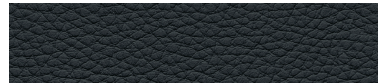

Leather upholstery covers the fronts of all seats and headrests.

<sup>1</sup> Not Available with M Sport Package.  
<sup>2</sup> Requires M Sport Package.

Interior trims

▲ □ 4MG Glacier Silver Aluminum<sup>6</sup>

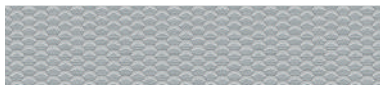

▲ □ 4A3 Light Burl Walnut Wood<sup>7</sup>



■ □ 4AS Gray Poplar Wood<sup>8</sup> (Standard in 135i)



■ ▲ 4AT High-Gloss Black<sup>9</sup> (Standard in 128i)

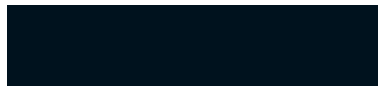

Recommended color combinations

Interior colors	Leatherette <sup>1</sup>		Boston Leather <sup>2</sup>				
	Taupe	Black	Savanna Beige/Black	Taupe	Gray	Coral Red	Black
Upholstery colors							
<b>Exterior colors</b>							
300 Alpine White Non-metallic <sup>3</sup>		●	●	●	●	●	●
▲ 61 Crimson Red Non-metallic <sup>1, 4</sup>		●	●	●	●	●	●
668 Jet Black Non-metallic <sup>1, 4</sup>		●	●	●	●	●	●
354 Titanium Silver Metallic <sup>2</sup>		●	●	●	●	●	●
▲ 72 Cashmere Silver Metallic <sup>2, 4</sup>		●	●	●	●	●	●
896 Blue Water Metallic <sup>2, 4</sup>		●	●	●	●	●	●
▲ 51 Montego Blue Metallic <sup>2, 4</sup>		●	●	●	●	●	●
▲ 76 Deep Sea Blue Metallic <sup>2, 4</sup>		●	●	●	●	●	●
381 Le Mans Blue Metallic <sup>2, 5</sup>		●	●	●	●	●	●
▲ 52 Space Gray Metallic <sup>2</sup>		●	●	●	●	●	●
▲ 79 Sedona Red Metallic <sup>2</sup>		●	●	●	●	●	●
475 Black Sapphire Metallic <sup>2</sup>		●	●	●	●	●	●
<b>Interior trims</b>							
4MG Glacier Silver Aluminum <sup>6</sup>							
4A3 Light Burl Walnut Wood <sup>7</sup>							
4AS Gray Poplar Wood <sup>8</sup>							
4AT High-Gloss Black <sup>9</sup>							
<sup>1</sup> Standard. <sup>2</sup> Optional, and included in Premium Package. <sup>3</sup> Optional. <sup>4</sup> Not Available with M Sport Package. <sup>5</sup> Requires M Sport Package. <sup>6</sup> Optional trim; requires Premium Package or M Sport Package in 128i. <sup>7</sup> Optional trim available at no-cost in 135i; optional and available as a no-cost choice in 128i Premium Package. <sup>8</sup> Standard 135i interior trim; optional and available as a no-cost choice in 128i Premium Package. <sup>9</sup> Standard 128i interior trim; available as a no-cost option in 135i.							



## EVOKE THE POWER AND BEAUTY OF THE SEA.

Sporty by day, elegant by night: Deep Sea Blue Metallic paint is a sophisticated offering in the 1 Series Coupe palette. Chrome Line exterior trim and sculpted 17 x 7.0 (Style 256) Star Spoke light alloy wheels add gleaming metallic accents. Like sunlit sand along the shoreline, the Savanna Beige Boston Leather upholstery and Light Burl Walnut Wood trim provide a warm welcome.



The sporty interior with adjustable front seats is strikingly rendered in Savanna Beige Boston Leather with Black accents.



The driver-oriented dash invites you to reach out and take command of the three-spoke, leather-wrapped multi-function sport steering wheel, and full-color Navigation system with iDrive Controller and monitor.



Genuine Light Burl Walnut Wood trim adds a touch of elegance to the beautifully crafted cabin.



BMW makes it easy to enter and exit from the 1 Series Coupe's rear cabin. Rear-seat passengers can make use of the handy center storage compartment, or fold down the comfortable armrest.



## THE SPORT PACKAGE SHOWS OFF THE 128i'S ATHLETIC PROWESS.

Volcanic heat and arctic cool. The 128i Coupe makes a dramatic entrance in Black Sapphire Metallic paint. Add the Sport Package, and it takes on a decidedly aggressive stance. The shadowline exterior trim, bold Star Spoke (Style 262) 17" light alloy wheels and run-flat<sup>1</sup> performance tires<sup>2</sup> add the look of serious performance, underscoring the effects of the sport suspension.

<sup>1</sup> Run-flat tires do not come equipped with spare tire and wheel.

<sup>2</sup> Due to low-profile tires, please note: wheels, tires and suspension parts are more susceptible to road hazard and consequential damages. Performance tires not recommended for driving in snow and ice.



Equipped with the Sport Package, the 128i Coupe shows off its star power with attractive Star Spoke (Style 262) light alloy wheels. In front: 17 x 7.0 wheels and 205/50 run-flat<sup>1</sup> performance tires; at the rear: 17 x 7.5 wheels and 225/45 run-flat<sup>1</sup> performance tires.<sup>2</sup>



Coral Red Boston Leather with Black accents heats up the action. But you'll sit tight in sharp turns, thanks to the cushioned support of adjustable side bolsters on the sport seats.



Set against the Coral Red Boston Leather interior, the Glacier Silver Aluminum trim on the dash, center console and doors visually cools things off.



■ / □ **Xenon Adaptive Headlights** provide brilliant clarity of the road ahead and to the side at night and in conditions with poor visibility. The dynamic auto-leveling feature adjusts for varying passenger and cargo loads, helping to keep headlight glare out of the eyes of oncoming drivers. BMW Adaptive Headlights provide optimum road illumination around corners, thanks to an electromechanical control system that directs the headlights into and around the bend as soon as the vehicle begins cornering. The Corona headlight-rings that circle both headlights and high beams also act separately as Daytime Running Lights and parking lights. (Standard on 135i; optional on 128i.) □ **Automatic high beams** uses light sensor readings to automatically switch from high beams to low, as needed – such as when there is oncoming traffic or another car ahead, or when the road is sufficiently illuminated.



■ / □ **High-intensity headlight washers** help keep lights clean of ice, mud, road salt and other coatings, for maximum road lighting and enhanced driving safety. (Retractable washers standard on 135i; fixed washers included in 128i Cold Weather Package. 135i shown.)



■ / □ **Two-way power glass moonroof** with remote, expanded one-touch operation, slides backward or tilts up to let in as much fresh air and sky as you like. Includes a sliding interior sunshade. (Standard on 135i; optional on 128i.)

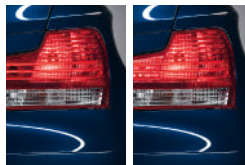

■ **Adaptive Brake Lights** increase vehicle visibility and signal the intensity of your braking action. In the event of an emergency stop, the illuminated area of the brake lights is increased, so traffic following behind you knows to stop quickly.



■ **Star Spoke (Style 256) 17 x 7.0 light alloy wheels with 205/50 run-flat<sup>1</sup> all-season tires.** (Standard on 128i.)



□ **Star Spoke (Style 142) light alloy wheels with run-flat<sup>1</sup> all-season tires.**  
In front: 17 x 7.0 wheels and 205/50 tires;  
in back: 17 x 7.5 wheels and 225/45 tires.<sup>3</sup>  
(No-cost option on 135i.)



□ **Star Spoke (Style 262) light alloy wheels and run-flat<sup>1</sup> performance tires.<sup>2</sup>**  
In front: 17 x 7.0 wheels and 205/50 tires;  
in back: 17 x 7.5 wheels and 225/45 tires.<sup>3</sup>  
(Included in 128i Sport Package.)



■ **Star Spoke (Style 264) light alloy wheels and run-flat<sup>1</sup> performance tires.<sup>2</sup>**  
In front: 18 x 7.5 wheels and 215/40 tires; in back: 18 x 8.5 wheels and 245/35 tires.<sup>3</sup>  
(Standard on 135i.)

<sup>1</sup> Run-flat tires do not come equipped with spare tire and wheel.

<sup>2</sup> Performance tires are not recommended for driving in snow and ice.

<sup>3</sup> Due to low-profile tires, please note: wheels, tires and suspension parts are more susceptible to road hazard and consequential damages.





■ **Three-spoke leather-wrapped multi-function sport steering wheel** lets you keep both hands on the wheel while adjusting various comfort functions, such as controls for audio system, cruise control and hands-free phone controls.



■ / □ **Steering wheel-mounted paddle shifters** allow you to shift gears manually without a clutch. In the 135i Coupe, they are included with the optional 7-speed Double Clutch Transmission (DCT). Optional steering wheel-mounted paddle shifters are automatically added in the 128i Coupe when equipped with optional STEPTRONIC automatic transmission and either the Sport Package or M Sport Package. Shown: the three-spoke, leather-wrapped multi-function M sport steering wheel.



□ **Harman Kardon Surround Sound Audio System** with vehicle-specific equalizing and powerful 300W amplifier. The 10-speaker system includes four tweeters, four midrange speakers, and two bass speakers located under the front seats.



■ **HD Radio™** receives free, digital AM/FM broadcasts across the U.S. in clear, static-free quality sound – AM sounds like FM; FM sounds like CD. Also enjoy new “multicast” FM stations, as well as a variety of innovative data services. Can be ordered with optional Harman Kardon Surround Sound Audio System.

For more information on HD Radio receivers and to find HD Radio AM/FM stations near you, visit [HDRadio.com](http://HDRadio.com).



□ **6-speed STEPTRONIC automatic transmission** provides the 128i Coupe with a choice of three modes: “Drive,” which incorporates BMW’s Adaptive Transmission Control; “Sport” automatic, for a more dynamic shift pattern; and STEPTRONIC automatic, for the hands-on control of a manual without using a clutch.



■ **Automatic climate control system** allows occupants to select a specific cabin temperature and choice of fan speeds, as well as automatic or manual airflow and recirculation. The automatic recirculation control activates whenever certain air pollutants are detected. The system also includes defrost/demist and MAX A/C functions.



□ **7-speed Double Clutch Transmission (DCT) with steering wheel-mounted paddle shifters** in the 135i provides smooth, lightning-quick gear changes by automatically shifting between two transmission structures: while one gear is disengaging, the next is already in position. The result is quicker acceleration and enhanced fuel efficiency. Shift gears manually via steering wheel-mounted paddle shifters or by moving gear selector lever forward/rearward.



□ **Navigation system** features a high-resolution, glare-free monitor. Using GPS satellites in conjunction with data stored on an internal hard drive, a choice of detailed maps show – and tell – the directions to your desired destination. In many areas, it also provides Real Time Traffic Information on potential traffic problems along your route, and can even plan a detour around them.



□ **Park Distance Control** uses ultrasonic sensors in the rear bumper to help you judge the distance to other cars and unseen objects when parking. The beeping becomes faster as your bumper approaches the object, turning into a constant tone when the distance is less than 12 inches.



□ **BMW Assist™1** and Bluetooth® system offers hands-free calling through your BMW-approved Bluetooth phone. The BMW Assist Safety Plan is included for four years, providing Automatic Collision Notification, Emergency and Roadside Assistance, Door Unlock, Stolen Vehicle Recovery, TeleService and more.

<sup>1</sup> The optional Convenience Plan offers Directions, Traffic, Weather, Critical Calling and Concierge services. See page 64 for detailed information on standard and optional services.



■ **Auxiliary input port** lets you connect an external audio source, such as an iPod® or MP3 player.

□ **iPod and USB adapter** lets you scroll through and select the music you want by using the vehicle’s radio controls or the multi-function steering wheel buttons. Music titles are displayed on the radio or Navigation screen.



■ **Cupholders** integrated into the center console are located within convenient reach of the driver and front passenger (as shown). Cars with optional Navigation system are fitted with one cupholder in the center console, and one attached in the passenger footwell.



■ **Front armrest** with integrated storage compartment folds up to allow access to the front cupholder(s), shown at left, and Auxiliary input port shown on page 49.



□ **Power seat adjustments** included with eight-way power front seats allow customized comfort and convenience for driver and front passenger. The two-setting memory system automatically adjusts the driver's seat and side-view mirror positions, with individual preferences available at your fingertips.



■ **Standard front seats**, shown here with optional Taupe Boston Leather upholstery and iDrive, offer eight-way manual adjustment including two-way adjustment of headrests. The front passenger seat also includes manual height adjustment.



□ **Eight-way adjustable front sport seats**, included in the Sport Package, make the driving experience more enjoyable. Side bolsters can be power-adjusted to fit your back comfortably while helping to hold you firmly in place during tight cornering. Includes two-way headrests and thigh support for added support. (Shown with optional Black Boston Leather upholstery and iDrive.)



□ **Heated front seats** are a welcome feature for driver and front passenger in cooler weather. By pressing the icon button, seat surface and backrest are heated and quickly radiate comfortable warmth in your choice of three settings. (Heated front seats are also included in the Cold Weather Package.)



■ **Lined luggage compartment** is illuminated and can be expanded by folding down the split-folding rear seats. An elastic strap on the left-hand side, a flexible storage net on the right and lashing points on the inside edge help to ensure safe transportation of cargo. (Shown with optional Cold Weather Package pass-through opening for ski bag.)

**Cold Weather Package:** Get to the slopes – or just get around town – in added comfort with the 1 Series Cold Weather Package. Front seat occupants will enjoy the pleasure of three-stage heated seats and the driver will have the added comfort of the heated multi-function steering wheel<sup>1</sup> on those days when the weather turns colder. High-intensity headlight washers<sup>2</sup> help maintain optimal nighttime visibility in all weather and driving conditions, and the ski bag is a must for protecting skis, poles and other long objects.

<sup>1</sup> Heated multi-function steering wheel not available with M Sport Package or 135i Sport Package.

<sup>2</sup> Retractable headlight washers standard in 135i.



**High-intensity headlight washers** help keep lights clean of ice, mud, road salt and other coatings, for maximum road lighting and enhanced driving visibility. (Retractable headlight washers standard in 135i; headlight washers in the 128i Cold Weather Package are not retractable.)

(135i retractable headlight washers shown.)



**Ski bag** allows clean and secure transport of four pairs of skis and ski poles as well as other long items. When the ski bag is not extended, it can be stored out of sight to save space, and the fold-down center armrest can be left down for use.



**Xenon Adaptive Headlights** provide daytime-like illumination at night and in conditions with poor visibility. When cornering, the Adaptive feature turns the headlights, directing them into and around bends. Corona headlight-rings that circle both headlights and high beams also act separately as Daytime Running Lights and parking lights. (Standard on 135i.)



**Comfort Access system** offers convenient keyless access to your car. Simply carrying the remote key in a pocket or purse allows you to lock or unlock the doors by touching the door handle. You can also turn the engine on or off by pressing the Start/Stop button without inserting the remote key. (Foot must be on the brake; with manual transmission, clutch must also be depressed in order to start.)



**Anti-theft alarm system** features remote control, an anti-theft device and electronic immobilizer for effective protection. In the event of an attempted break-in or any tampering with the vehicle, the system sounds an alarm and immediately switches on the hazard warning lights.



**Park Distance Control** uses ultrasonic sensors in the rear bumper to help you judge the distance to other cars and unseen objects when parking. The beeping becomes faster as your bumper approaches the object, turning into a constant tone when the distance is less than 12 inches. (Shown with optional Navigation system.)

In the **Premium Package**, eight-way power-adjustable front seats, upholstered in supple Boston Leather, offer the customized comfort of four-way lumbar support. Overhead, a two-way glass moonroof slides backwards or tilts up so you can enjoy the fresh air and open skies to the fullest. At night you'll appreciate the enhanced visibility afforded by the Ambiance light package, as well as the auto-dimming function of the rear-view and side-view mirrors. BMW Assist™<sup>1</sup> offers roadgoing peace of mind, while Bluetooth® wireless technology lets you keep in touch without taking your eyes from the road. And the integrated three-button Universal garage-door opener takes the place of up to three separate remote-control devices, helping to eliminate clutter.

<sup>1</sup>The Convenience Plan offers Directions, Traffic, Weather, Critical Calling and Concierge services. See page 64 for detailed information on standard and optional services.



**Ambiance light package** includes lights in the exterior door handles that radiate downward whenever the doors are unlocked. They illuminate the area outside the doors for approximately 20 seconds to enable safe vehicle access in the dark. Also included are front and rear reading lights, front footwell illumination, vanity mirror lights for driver and front passenger, and ambiance interior lighting.



**Power-folding exterior side-view mirrors** automatically dim when reflecting bright lights, helping to eliminate glare when driving at night.



The **automatic-dimming inside rear-view mirror** darkens in response to the bright headlights of vehicles behind you. The easy-to-read digital compass, integrated into the mirror, is a convenient way to constantly keep your bearings while driving.



**BMW Assist™**<sup>1</sup> and Bluetooth system offers hands-free calling through your BMW-approved Bluetooth phone. The BMW Assist Safety Plan is included for four years, providing Automatic Collision Notification and more.



**Power seat adjustments** included with eight-way power front seats allow customized comfort and convenience for driver and front passenger. The two-setting memory system automatically adjusts the driver's seat and side-view mirror positions so individual preferences are always available at the touch of a button.



**Lumbar support** for front seats adds four-way power-adjustable comfort for the lower back. Lumbar support can be adjusted up/down and in/out.

**Sport Package:** Inject more excitement into every drive. Specially bolstered eight-way adjustable sport seats cradle you comfortably while holding you firmly in place during sporty driving maneuvers. Eye-catching shadowline trim around the windows and door sills add to the Coupe's sporty appearance. In the 128i, larger rear wheels and run-flat<sup>2</sup> performance tires<sup>3</sup> team up with the sport-tuned suspension to grip corners with a vengeance.

<sup>2</sup>Run-flat tires do not come equipped with spare tire and wheel.

<sup>3</sup>Performance tires are not recommended for driving in snow and ice. Due to low-profile tires, please note: wheels, tires and suspension parts are more susceptible to road hazard and consequential damages.



**Shadowline trim** gives a sporty look to front and rear side-window frames, window recess finishers, and door-sill trim strips.



**Star Spoke (Style 262) light alloy wheels and run-flat<sup>2</sup> performance tires.**<sup>3</sup> In front: 17 x 7.0 wheels and 205/50 tires; in back: 17 x 7.5 wheels and 225/45 tires. (Included in 128i Sport Package.)

**Three-spoke, leather-wrapped multi-function M sport steering wheel**, included in the 135i Sport Package, lets you keep both hands on the wheel while adjusting various comfort functions, such as changing the radio, CD selections and volume. Optional Voice command (included with optional Navigation system) can be used to change radio stations and audio selection, Navigation system destinations, and (accessory) telephone entries. When equipped with optional 7-speed Double Clutch Transmission, includes steering wheel-mounted paddle shifters. (M sport steering wheel not available with heated steering wheel feature, or 128i Sport Package.)



**Eight-way adjustable front sport seats** make the driving experience more enjoyable. Side bolsters can be power-adjusted to fit your back comfortably while helping to hold you firmly in place during cornering. Includes two-way manual headrests and thigh support. (If ordered with power seats or the Premium Package, the sport seats are eight-way power and include two presets for seat and exterior mirror positions.)



For details on the availability of standard and optional features, please refer to the Standard equipment | Optional equipment charts at the back of this brochure.

**M Sport Package:** Bring the proud tradition of BMW M right to your doorstep, starting with the tri-color M logo on the door sills. Bolstered front sport seats, coupled with the three-spoke multi-function M sport steering wheel,<sup>1</sup> add to the driving excitement. And black shadowline trim, which surrounds the windows and door sills, projects the image of serious performance. An Aerodynamic kit, sport suspension, M Double Spoke (Style 207M) light alloy wheels (17 x 7.0 front/17 x 7.5 rear) and run-flat<sup>2</sup> performance tires<sup>3</sup> are included in the 128i M Sport Package; the 135i M Sport Package adds M Double Spoke (Style 261M) light alloy wheels (18 x 7.5 front/18 x 8.5 rear) and run-flat<sup>2</sup> performance tires.<sup>3</sup>



**Shadowline trim** on the front and rear side-window frames, window recess finishers, and door-sill trim strips give the coupe a more aggressive appearance.



**BMW Double Spoke (Style 207M) light alloy wheels and run-flat<sup>2</sup> performance tires.<sup>3</sup>**  
In front: 17 x 7.0 wheels and 205/50 tires; in back: 17 x 7.5 wheels and 225/45 tires. (128i M Sport Package.)

<sup>1</sup>When the M Sport Package and STEPTRONIC automatic transmission are ordered in the 128i, optional steering wheel-mounted paddle shifters are automatically added.

<sup>2</sup>Run-flat tires do not come equipped with spare tire and wheel.

<sup>3</sup>Performance tires are not recommended for driving in snow and ice. Due to low-profile tires, please note: wheels, tires and suspension parts are more susceptible to road hazard and consequential damages.



**BMW Double Spoke (Style 261M) light alloy wheels and run-flat<sup>2</sup> performance tires.<sup>3</sup>**  
In front: 18 x 7.5 wheels and 215/40 tires; in back: 18 x 8.5 wheels and 245/35 tires. (135i M Sport Package.)



**Door sills** with the instantly identifiable M logo announce that this is a special breed of coupe as soon as a door is opened.



**Three-spoke, leather-wrapped multi-function M sport steering wheel<sup>1</sup>** is included in the M Sport Package. Proudly displaying the M logo in the center spoke, it features multi-function buttons that allow you to keep both hands on the wheel while adjusting various comfort functions, such as changing the radio, CD selections and volume.



**Eight-way adjustable front sport seats** make the driving experience more enjoyable. Side bolsters can be power-adjusted to fit you back comfortably while helping to hold you firmly in place during cornering. Includes two-way manual headrests and thigh support.

#### Exclusively in the BMW 135i Coupe:

A wealth of unique styling and performance enhancements come standard. The 135i's specially calibrated sport suspension and sporty throttle character make the most of its 300-hp TwinPower Turbo engine. Oversize ventilated disc brakes provide uncanny stopping power for the Star Spoke (Style 264) light alloy wheels (18 x 7.5 front/18 x 8.5 rear)<sup>4</sup> and run-flat<sup>2</sup> performance tires.<sup>3</sup> Xenon Adaptive Headlights and heated headlight washer jets improve your roadgoing vision. A special front apron with functional air intakes enhances the 135i's handling, while the addition of the understated spoiler on the rear deck increases stability at higher speeds. The Aerodynamic kit includes side skirts and a sporty rear apron, lending it an even more distinctive, chiseled look. And inside, genuine wood trim and a two-way power glass moonroof come standard – as does the enthralling 135i driving experience.

<sup>4</sup>17 x 7.0 front/17 x 7.5 rear Star Spoke (Style 142) wheels with run-flat<sup>2</sup> all-season tires are available as a no-cost option.



**Rear spoiler** adds to the excellent driving dynamics by keeping the rear of the car stable at higher speeds.



**Front apron** sits below the BMW double kidney-shaped grille with chrome slats. This feature, which brings a constant flow of fresh air to the engine, adds to the front's impressive athletic profile. The central air intake is flanked by two side air intakes that cool the brakes. Two side flaps accentuate the broad front.



**Black chrome-plated double tailpipe** is standard on the 135i Coupe's exhaust system.



**High-performance disc brakes**, with inner ventilation and "BMW" painted on the callipers (6-piston callipers in front/2-piston callipers in the rear) measure 13.3" front/12.8" rear. Designed for high-performance driving, their large diameters help provide shorter braking distances and superior stopping ability.

**Dashboard** features easy-to-read numbers with special scales that include additional display ranges in the instrumentation.



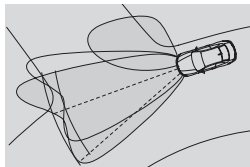

■ / □ **Xenon Adaptive Headlights** automatically swivel to follow the curves of the road. The system uses data from on-board sensors and the steering wheel angle to determine the car's direction, then adjusts the headlights accordingly. The system offers outstanding nighttime vision. (Standard on 135i; optional on 128i.)

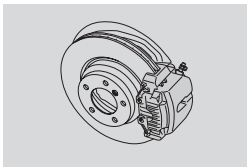

■ **Massive, high-performance anti-lock disc brakes** are ventilated at all four wheels for fade-resistant operation under hard use. (See page 63 for brake diameter sizes.)

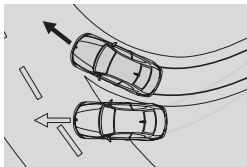

■ **Dynamic Stability Control (DSC) with Dynamic Traction Control (DTC)** features Brake Drying, Brake Stand-by, Brake Fade Compensation and Start-off Assistant. DSC is a braking control system that helps to stabilize a vehicle when it senses a loss of control. If the system senses over- or understeer, it responds with counter-measures to help keep the vehicle under control.

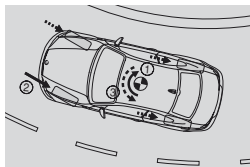

■ **Cornering Brake Control** increases vehicle stability by proportioning the braking force while turning. When you brake in a turn, the pressure comes off the rear wheels, which causes the vehicle to swerve inward (oversteer) (1). Cornering Brake Control counteracts this action by asymmetrically adjusting brake pressure (2), creating stabilizing counter-torque (3), independently of the ABS system.

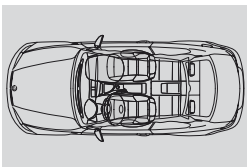

■ In a collision, BMW's **SRS (supplemental restraint system)** with advanced technology for the front airbags determines which airbags to deploy for optimal protection. The system also includes front-seat-mounted side-impact airbags and HPS (Head Protection System) and rear.

Please note: These pictures of airbags are for illustrative purposes only. Depending upon the type of accident, none, some or all airbags may deploy.



■ **BMW restraint system** for the driver and front passenger combines three-point safety belts, automatic safety-belt pretensioners, head restraints, and seat bolsters that help prevent occupants from sliding forward. This system helps provide optimum restraint in a collision.

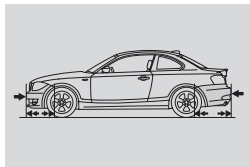

■ **Impact-absorbing bumpers** and compressible "crush tubes" front and rear help absorb the force of impact in collisions up to nine mph, minimizing damage to the vehicle's body and simplifying repairs. Only at higher impact speeds do structural supports begin to deform, dissipating impact energy to help protect occupants.

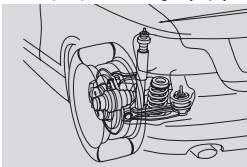

■ **Tire Pressure Monitor** is an electronic control system designed to warn the driver if there is a sudden and irregular loss of tire pressure. Should the target pressure of a tire fall below 25%, a warning light alerts the driver.

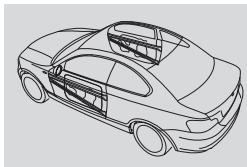

■ BMW's **door anchoring system** includes reinforcing bars with hook-like members within each door. In a serious side impact, the bars hook the door to the body, locking them together to make a more rigid passenger cell. When the pressure is released, the anchoring system is designed to disengage so that the doors can be opened (unless further damage from the impact prevents them from opening).

Performance and efficiency	128i	135i
3.0-liter dual overhead cam (DOHC), 24-valve inline 230-hp 6-cylinder engine with composite magnesium/aluminum engine block, Valvetronic, and Double-VANOS steplessly variable valve timing	●	
3.0-liter dual overhead cam (DOHC), 24-valve inline turbocharged 300-hp 6-cylinder engine with TwinPower Turbo technology, piezo fuel injection, and Double-VANOS steplessly variable valve timing		●
Electronic throttle control	●	●
6-speed manual transmission	●	●
6-speed STEPTRONIC automatic transmission with Adaptive Transmission Control	○	
7-speed Double Clutch Transmission (includes steering wheel-mounted paddle shifters)		○
Steering wheel-mounted paddle shifters (included with 7-speed Double Clutch Transmission; require and are automatically added with either Sport Package or M Sport Package and STEPTRONIC transmission)	○	○

Handling, ride and braking		
Dynamic Stability Control (DSC), including Brake Fade Compensation, Start-off Assistant, Brake Drying, and Brake Stand-by features, with Dynamic Traction Control (DTC)	●	●
Extensive aluminum componentry, including front suspension components (forged-aluminum lower arms); subframe; steering rack; and brake components	●	●
Aluminum double-pivot spring and strut-type front suspension	●	●
Five-link fully independent rear suspension in lightweight steel	●	●
Front and rear anti-roll (stabilizer) bars	●	●
Twin-tube gas-pressure shock absorbers	●	●
Sport suspension calibration	□■	●
4-wheel ventilated anti-lock disc brakes with Dynamic Brake Control (DBC)	●	●
Active Steering		○
Increased top-speed limiter	□■	□■

Exterior and aerodynamics		
Star Spoke (Style 256) 17 x 7.0 light alloy wheels and 205/50 run-flat <sup>1</sup> all-season tires	●	●
Star Spoke (Style 264) light alloy wheels, 18 x 7.5 front, 18 x 8.5 rear; 215/40 front, 245/35 rear run-flat <sup>1</sup> performance tires <sup>2,3</sup>		●
Star Spoke (Style 262) light alloy wheels, 17 x 7.0 front, 17 x 7.5 rear; 205/50 front, 225/45 rear run-flat <sup>1</sup> performance tires <sup>2,3</sup>	□	●
Star Spoke (Style 142) light alloy wheels, 17 x 7.0 front, 17 x 7.5 rear; 205/50 front, 225/45 rear run-flat <sup>1</sup> all-season tires <sup>2</sup>		▲
M Double Spoke (Style 207M) light alloy wheels, 17 x 7.0 front, 17 x 7.5 rear; 205/50 front, 225/45 rear run-flat <sup>1</sup> performance tires <sup>2,3</sup>	■	●
M Double Spoke (Style 261M) light alloy wheels, 18 x 7.5 front, 18 x 8.5 rear; 215/40 front, 245/35 rear run-flat <sup>1</sup> performance tires <sup>2,3</sup>		■
Xenon Adaptive Headlights with auto-leveling, and Cornering Lights	○◆	●
Automatic high beams	○	○
Halogen free-form front foglights	●	●
High-intensity headlight washers	★	●
Heated dual power mirrors and heated windshield washer jets	●	●
Chrome-plated exhaust tips	●	●
Black chrome-plated exhaust tips		●
Gray-band windshield	●	●
Rear spoiler		●
Aerodynamic kit		●
Chrome-line exterior trim	●	●
Shadowline exterior trim	□	□
Metallic paint	○	○

- Standard
- Optional
- Included in Sport Package
- Included in M Sport Package
- ◆ Included in Convenience Package
- ★ Included in Cold Weather Package
- ▲ No-cost option

<sup>1</sup> Run-flat tires do not come equipped with spare tire and wheel.  
<sup>2</sup> Performance tires are not recommended for driving in snow and ice.  
<sup>3</sup> Due to low-profile tires, please note: wheels, tires and suspension parts are more susceptible to road hazard and consequential damages.

Interior seating and trim	128i	135i
8-way adjustable front seats, including 2-way headrests	●	●
Manual height adjustment for front passenger seat	●	●
8-way power front seats with 2-way manual headrests and driver memory with 2 presets for seat and exterior mirror positions	○◇	○◇
8-way adjustable front sport seats with adjustable side bolsters, 2-way headrests and thigh support	□■	□■
8-way power front sport seats with adjustable side bolsters, 2-way manual headrests and thigh support, and driver memory with 2 presets for seat and exterior mirror positions (optional power seats or Premium Package required)	□■	□■
4-way adjustable power lumbar support for front seats	◇	◇
Leatherette upholstery	●	●
Boston Leather upholstery (covers the fronts of all seats and headrests)	○◇	○◇
Anthracite headliner	■	■
High-Gloss Black trim	●	▲
Gray Poplar Wood trim	○◇	●
Glacier Silver Aluminum trim (requires Premium Package or M Sport Package)	◇	▲
Light Burl Walnut Wood trim	○◇	▲
3-stage heated front seats	○★	○★
Split fold-down rear seats	●	●
M Sport Package stainless steel door sills with M logo	■	■
Ski bag	★	★

### Comfort and convenience

Engine Start/Stop button	●	●
Comfort Access keyless entry with multi-function remote control	○◆	○◆
2-way power glass moonroof with "one-touch" operation and sliding interior sunshade	○◇	●
Automatic climate control – includes micro-filter, automatic air recirculation, left/right temperature control, MAX A/C, heat at rest, and recall of individual user settings	●	●
Front-door storage compartments	●	●
Front-seat center armrest	●	●
Front-seat cupholders	●	●
Tilt/telescopic steering-wheel column	●	●
Heated steering wheel (not available with M Sport Package or 135i Sport Package)	★	★
Park Distance Control (PDC) (rear only)	○◆	○◆
Interior and power-adjustable folding exterior mirrors with automatic-dimming function	◇	◇
Digital interior mirror compass	◇	◇
Power front windows with "one-touch" up/down operation	●	●
Cruise Control	●	●
Automatic high beams	○	○
Ambiance light package, including BMW Ambiance interior lighting	◇	◇
Rain-sensing windshield wipers and Automatic headlight control	●	●
Integrated 3-button Universal garage-door opener	◇	◇

- Standard
- Optional
- Included in Sport Package
- Included in M Sport Package
- ◇ Included in Premium Package
- ▲ No-cost option
- ★ Included in Cold Weather Package
- ◆ Included in Convenience Package

Instrumentation and controls	128i	135i
3-spoke leather-wrapped multi-function sport steering wheel with audio and hands-free phone controls (if so equipped)	●	●
3-spoke leather-wrapped multi-function M sport steering wheel with audio and hands-free phone controls (if so equipped)	■	□■
Service Interval Indicator with miles-to-service readout	●	●
Check Control vehicle monitor system with pictogram display, oil status display, and Condition Based Service indicator	●	●
Tire Pressure Monitor	●	●
On-board computer with Check Control – provides feedback on the vehicle's operating status; oil level indicator and distance to next service appointment (oil change, as well as other detailed information, such as spark plug and micro-filter status. It also provides travel information – travel range on remaining fuel, external temperature, and more	●	●
BMW Navigation system with Voice Command System and Real Time Traffic Information (where available); iDrive system with high-function on-board computer and Controller, with 6 programmable memory buttons (also includes Online Information Services when equipped with BMW Assist™)	○	○

### Audio system

Anti-theft AM/FM stereo CD/MP3 player audio system with Radio Data System (RDS)	●	●
Harman Kardon Surround Sound Audio System with vehicle-specific equalizing and powerful 300W amplifier; the 10-speaker system includes 4 tweeters, 4 midrange speakers, and 2 bass speakers located under the front seats	○	○
Auxiliary audio input for portable music players located in the center armrest	●	●
SIRIUS Satellite Radio with one-year subscription	○	○
iPod® and USB adapter (includes cable connector)	○	○
Smartphone Integration (requires iPod and USB adapter and Premium Package or BMW Assist)	○	○
HD Radio™ with "multicast" FM station reception	●	●

### Safety and security

Anti-lock braking system (ABS)	●	●
Adaptive Brake Lights	●	●
BMW's Advanced Safety System for integrated deployment of passive and active safety systems	●	●
Front and rear Head Protection System (HPS)	●	●
Driver's and passenger's front airbag supplemental restraint system (SRS) with advanced technology: dual-threshold, dual-stage deployment; and front-passenger seat sensors designed to prevent unnecessary airbag deployment	●	●
Front passenger seat-occupation recognition with Passenger's Airbag Off indicator	●	●
Automatic safety-belt pretensioners at front seating positions	●	●
Front-seat-mounted front side-impact airbags	●	●
Interlocking door anchoring system to help protect against door intrusion in side impacts	●	●
Central locking system with center console switch (leaves gas filler door unlocked), double-lock feature and 2-step unlocking	●	●
Coded Driveway Protection	●	●
Automatic-locking retractors (ALR) on all passenger-seat safety belts for installation of child-restraint seat	●	●
LATCH attachments for child-restraint safety installation in rear seats	●	●
Crash sensor that activates Battery Safety Terminal disconnect of alternator, fuel pump and starter from battery; automatically unlocks doors, and turns on hazard and interior lights	●	●
Programmable Daytime Running Lights	●	●
Anti-theft alarm system	○◆	○◆
BMW Assist with Bluetooth® wireless technology for hands-free calling (with Bluetooth enabled mobile phone), with phonebook downloading and speech recognition capabilities (please visit your authorized BMW center for details on standard and optional services and a list of BMW-approved Bluetooth technology enabled mobile phones; also includes Online Information Services when equipped with BMW Navigation system)	○◇	○◇

### BMW Services

BMW Ultimate Service™ (for complete details on BMW Ultimate Service, visit <a href="http://bmwusa.com/ultimateservice">bmwusa.com/ultimateservice</a> )	●	●
---	---	---

Premium Package	128i	135i
2-way power glass moonroof with "one-touch" operation and sliding interior sunshade	○◇	●
8-way power front seats with 2-way manual headrests and driver memory with 2 presets for seat and exterior mirror positions	◇	◇
4-way adjustable power lumbar support for front seats	◇	◇
Boston Leather upholstery (covers the fronts of all seats and headrests)	◇	◇
Interior and power-adjustable folding exterior mirrors with automatic-dimming function	◇	◇
Digital interior mirror compass	◇	◇
Ambiance light package, including BMW Ambiance interior lighting	◇	◇
Integrated 3-button Universal garage-door opener	◇	◇
BMW Assist™ with Bluetooth® wireless technology for hands-free calling (with Bluetooth enabled mobile phone), with phonebook downloading and speech recognition capabilities (please visit your authorized BMW center for details on standard and optional services and a list of BMW-approved Bluetooth technology enabled mobile phones; also includes Online Information Services when equipped with BMW Navigation system)	◇	◇
Aluminum or Wood interior trim	○◇	●

Sport Package (Not available with M Sport Package)		
Star Spoke (Style 262) light alloy wheels, 17 x 7.0 front, 17 x 7.5 rear; 205/50 front, 225/45 rear run-flat <sup>4</sup> performance tires <sup>5, 6</sup>	□	
8-way adjustable front sport seats with adjustable side bolsters, 2-way headrests and thigh support	□	□
8-way power front sport seats with adjustable side bolsters, 2-way manual headrests and thigh support, and driver memory with 2 presets for seat and exterior mirror positions (optional power seats or Premium Package required)	□	□
Sport suspension calibration	□	●
3-spoke leather-wrapped multi-function M sport steering wheel with audio and hands-free phone controls (if so equipped) (not available with Heated steering wheel; includes paddle shifters when equipped with 7-speed Double Clutch Transmission)	□	□
Steering wheel-mounted paddle shifters (included with 7-speed Double Clutch Transmission; require and are automatically added with either Sport Package or M Sport Package and STEPTRONIC transmission)	○	○
Shadowline exterior trim	□	□
Increased top-speed limiter	□	□

M Sport Package (Not available with Sport Package)		
M Double Spoke (Style 207M) light alloy wheels, 17 x 7.0 front, 17 x 7.5 rear; 205/50 front, 225/45 rear run-flat <sup>4</sup> performance tires <sup>5, 6</sup>	■	
M Double Spoke (Style 261M) light alloy wheels, 18 x 7.5 front, 18 x 8.5 rear; 215/40 front, 245/35 rear run-flat <sup>4</sup> performance tires <sup>5, 6</sup>	■	■
8-way adjustable front sport seats with adjustable side bolsters, 2-way headrests and thigh support	■	■
8-way power front sport seats with adjustable side bolsters, 2-way manual headrests and thigh support, and driver memory with 2 presets for seat and exterior mirror positions (optional power seats or Premium Package required)	■	■
Sport suspension calibration	■	●
3-spoke leather-wrapped multi-function M sport steering wheel with audio and hands-free phone controls (if so equipped) (not available with Heated steering wheel; includes paddle shifters when equipped with 7-speed Double Clutch Transmission)	■	■
Steering wheel-mounted paddle shifters (included with 7-speed Double Clutch Transmission; require and are automatically added with either Sport Package or M Sport Package and STEPTRONIC transmission)	○	○
Shadowline exterior trim	■	■
Aerodynamic kit	■	●
M door sills with M logo, M footrest, M gearshift knob, and M handbrake lever	■	■
Athracite headliner	■	■
Increased top-speed limiter	■	■

- Standard
- Optional
- Included in Sport Package
- Included in M Sport Package
- ◇ Included in Premium Package
- ★ Included in Cold Weather Package
- ▲ No-cost option
- ◆ Included in Convenience Package

<sup>4</sup> Run-flat tires do not come equipped with spare tire and wheel.  
<sup>5</sup> Performance tires are not recommended for driving in snow and ice.  
<sup>6</sup> Due to low-profile tires, please note: wheels, tires and suspension parts are more susceptible to road hazard and consequential damages.

Cold Weather Package	128i	135i
Ski bag	★	★
3-stage heated front seats	★	★
High-intensity headlight washers	★	●
Heated steering wheel (not available with M Sport Package or 135i Sport Package)	★	★

Convenience Package		
Xenon Adaptive Headlights with auto-leveling, and Cornering Lights	○◆	●
Comfort Access keyless entry with multi-function remote control	○◆	○◆
Park Distance Control (PDC) (rear only)	○◆	○◆
Anti-theft alarm system	○◆	○◆

Stand-alone Optional Equipment		
6-speed STEPTRONIC automatic transmission with Adaptive Transmission Control	○	
7-speed Double Clutch Transmission (includes steering wheel-mounted paddle shifters)		○
Steering wheel-mounted paddle shifters (included with 7-speed Double Clutch Transmission; require and are automatically added with either Sport Package or M Sport Package and STEPTRONIC transmission)	○	○
Active Steering		○
Star Spoke (Style 142) light alloy wheels, 17 x 7.0 front, 17 x 7.5 rear; 205/50 front, 225/45 rear run-flat <sup>4</sup> all-season tires <sup>6</sup>		▲
2-way power glass moonroof with "one-touch" operation and sliding interior sunshade	○◇	●
Xenon Adaptive Headlights with auto-leveling, and Cornering Lights	○◆	●
Automatic high beams	○	○
Metallic paint	○	○
8-way power front seats with 2-way manual headrests and driver memory with 2 presets for seat and exterior mirror positions	○◇	○◇
Boston Leather upholstery	○◇	○◇
Gray Poplar Wood trim	○◇	
Glacier Silver Aluminum trim (requires Premium Package or M Sport Package)	○◇	▲
Light Burl Walnut Wood trim	○◇	▲
3-stage heated front seats	○★	○★
Comfort Access keyless entry with multi-function remote control	○◆	○◆
Park Distance Control (PDC) (rear only)	○◆	○◆
Anti-theft alarm system	○◆	○◆
Harman Kardon Surround Sound Audio System with vehicle-specific equalizing and powerful 300W amplifier; the 10-speaker system includes 4 tweeters, 4 midrange speakers, and 2 bass speakers located under the front seats	○	○
SIRIUS Satellite Radio with one-year subscription	○	○
iPod® and USB adapter (includes cable connector)	○	○
Smartphone Integration (requires iPod and USB adapter and Premium Package or BMW Assist)	○	○
BMW Navigation system with Voice command System and Real Time Traffic Information (where available); iDrive system with high-function on-board computer and Controller, with 6 programmable memory buttons (also includes Online Information Services when equipped with BMW Assist)	○	○
BMW Assist with Bluetooth wireless technology for hands-free calling (with Bluetooth enabled mobile phone), with phonebook downloading and speech recognition capabilities (please visit your authorized BMW center for details on standard and optional services and a list of BMW-approved Bluetooth technology enabled mobile phones; also includes Online Information Services when equipped with BMW Navigation system)	○◇	○◇

Weight		128i	135i
Unladen weight	lb	3252 (3329)	3373 (3439)
Weight distribution, front/rear			
Manual transmission	%	50.8/49.2	51.6/48.4
Automatic transmission (128i: STEPTRONIC transmission; 135i: 7-speed Double Clutch Transmission [DCT])	%	51.3/48.7	51.9/48.1
Permitted payload	lb	794	794
Permitted axle load, front/rear	lb	2028/2293	2116/2293
Permitted roof load	lb	165	165

Engine		128i	135i
Liters/type/valves per cylinder		3.0/inline 6/4	TwinPower Turbo 3.0/inline 6/4
Displacement	cu cm	2996	2979
Bore/Stroke	inch	3.35/3.46	3.31/3.53
Nominal output @ rpm	hp	230 @ 6500	300 @ 5800
Maximum torque @ rpm	lb-ft	200 @ 2750	300 @ 1200-5000
Compression ratio	-:1	10.7	10.2

Transmission		128i	135i
Manual transmission gear ratios			
I/II/III	-:1	4.30/2.46/1.66	4.11/2.32/1.54
IV/V/VI/R	-:1	1.23/1.00/0.85/3.94	1.18/1.00/0.85/3.73
Final drive ratio	-:1	3.23	3.08
Automatic transmission gear ratios			
I/II/III/IV	-:1	4.07/2.37/1.55/1.16	4.78/3.06/2.15/1.68
V/VI/VII/R	-:1	0.85/0.67/—/3.20	1.39/1.20/1.00/4.45
Final drive ratio	-:1	3.73	2.56

Performance		128i	135i
Top speed <sup>1</sup>	mph	131 [149]	131 [149]
Acceleration 0-60 mph <sup>2</sup> (128i: STEPTRONIC transmission; 135i: 7-speed Double Clutch Transmission [DCT])	sec	6.1 (6.7)	5.1 (5.0)

Fuel consumption <sup>3</sup>		128i	135i
Manual transmission – City/Highway	mpg	18/28	TBD/TBD
Automatic transmission – City/Highway (128i: STEPTRONIC transmission; 135i: 7-speed Double Clutch Transmission [DCT])	mpg	19/28	TBD/TBD
Fuel tank capacity, approx.	gal	14	14

Figures in [ ] apply to vehicles with automatic transmission, if different from manual transmission.  
 Figures in [ ] apply to vehicles with Sport Package or M Sport Package with increased top-speed limiter.

<sup>1</sup>Top speed limited electronically, All-season tires limited to 131 mph.

<sup>2</sup>BMW AG test results. BMW urges you to obey all posted speed laws and always wear safety belts.

<sup>3</sup>EPA-estimated figures are for comparison purposes only. Your actual mileage will vary, depending on speed, driving habits, trip length and driving conditions; actual mileage may be lower.

Tires and wheels		128i	135i
Tire dimensions – standard	front rear	205/50 205/50	215/40 245/35
Wheel dimensions – standard	front rear	17 x 7.0 17 x 7.0	18 x 7.5 18 x 8.5
Material		light cast alloy	light cast alloy

Brakes		128i	135i
Front – diameter	inch	11.8	13.3
Rear – diameter	inch	11.8	12.8

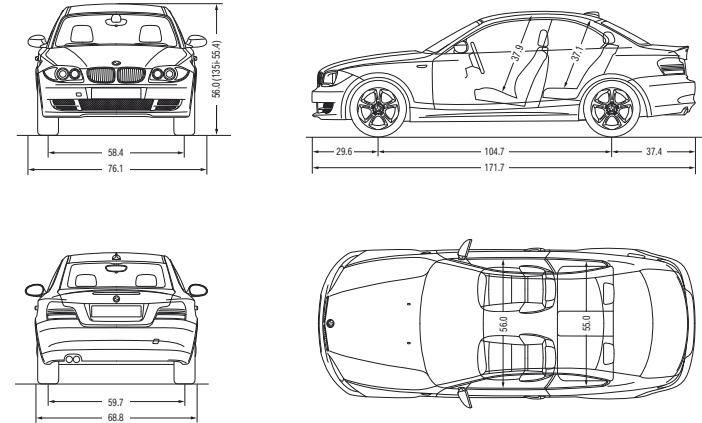

All dimensions are shown in inches and apply to models with standard wheels.



**We constantly monitor your BMW's needs – so you don't have to.** Tracking mountain switchbacks, the last thing you should be thinking about is the state of your brake pads. Thanks to BMW's integrated on-board diagnostics system, you will always know exactly when the next service is due, and what work will be required.

Condition-Based Service (CBS) measures the condition of key parts that are subject to wear and tear. It also tracks fluid levels and monitors your BMW's time- and mileage-dependent service requirements. Using this data, the Info

Display in the cockpit automatically alerts you in advance whenever any part of your vehicle will require servicing. You can also use the optional iDrive Control Display to find out which components will need to be serviced, and when.

When combined with TeleService – the innovative telematics service included with the optional BMW Assist™ Safety Plan<sup>1</sup> – the CBS-collected data is automatically transmitted to your BMW center, which then contacts you to set up a service appointment. And because they use only **Original BMW Parts**, you can rely on expert fit and long-lasting BMW quality.

## JOY IS THE FEELING OF BEING LOOKED AFTER BY THE BEST. BMW SERVICE FOR YOUR BMW.

**BMW Ultimate Service™** At BMW, we believe that a premium ownership experience should feature performance and luxury, as well as safety and convenience. We believe you should be able to drive a BMW to its potential, while enjoying peace of mind and reduced cost of ownership. That's the idea behind BMW Ultimate Service: a suite of comprehensive programs and services that are included in every 2009 and later model year vehicle. The New Vehicle Limited Warranty, the BMW Maintenance Program, and Roadside Assistance come standard, with BMW Assist offered as an option. BMW Ultimate Service starts with the

**New Vehicle Limited Warranty**, providing you with coverage for the first four years or 50,000 miles, whichever comes first. Additionally, you have 12-year, unlimited-mileage warranty protection against corrosion and rust perforation.<sup>2</sup> **BMW Maintenance Program** is one of the most comprehensive maintenance programs in its class. We cover all factory-recommended maintenance during the New Vehicle Limited Warranty coverage period. This includes scheduled oil services and inspections. Also covered is the replacement of items that are subject to normal wear and tear, such as brake pads, wiper blade inserts and engine drive belts.<sup>3</sup> And, thanks to BMW's advanced engineering, most owners enjoy a well-balanced maintenance schedule, with flexible routine service intervals that can save you time. When your vehicle requires attention, your authorized BMW center ensures that it receives only genuine BMW parts – your assurance of exacting quality standards.

**BMW Roadside Assistance** is provided free of charge for the first four years – with no mileage limit. Call **1-800-332-4BMW (4269)** for friendly on-the-road help, 24/7, anywhere in the United States, Canada and Puerto Rico. This includes everything from flat-tire changes, emergency gasoline and lock-out service, to towing, alternative transportation and even trip-interruption benefits. This service also provides valuable trip-routing advice.

The **BMW Assist Safety Plan** is an optional four-year program. You'll enjoy peace of mind knowing that a friendly response specialist is there to help you, 24/7, at just the push of a button. The Safety Plan includes Automatic Collision Notification, Emergency Request, Enhanced Roadside Assistance, Door Unlock, Stolen Vehicle Recovery and Customer Relations. MyInfo allows you to send business locations and street addresses with their associated phone numbers from the Google Maps™ website directly to your BMW. The destination can be sent to your Navigation system for turn-by-turn directions, and you can call the destination via your Bluetooth® linked cell phone. And for the ultimate in coverage, add the optional **Convenience Plan**.<sup>4</sup> You'll enjoy unlimited access to personalized Directions, Traffic and Weather reports, as well as our Concierge feature, which can send a destination address and phone number, such as a restaurant or hotel, right to your BMW. You can make up to four operator-assisted calls per year with Critical Calling if your cell phone is not available, or if its battery is discharged. BMW Search™ allows online access to up-to-date fuel prices and the latest weather forecasts, as well as Bloomberg's stock indices and the powerful reach of the Google Maps database – delivered to the iDrive display right inside your vehicle.

BMW's unique **TeleService**, included in the BMW Assist Safety Plan, continually monitors specific parts that are subject to wear and tear – including the engine oil, micro-filter, spark plugs, brake linings and various fluids – as well as services that require attention at regular intervals, such as vehicle service inspections. This data is automatically transmitted to your BMW center, which will then call you to schedule a service appointment. You don't have to keep track of when your vehicle requires routine maintenance. An added benefit: any needed maintenance service parts will already be on hand, so your BMW is serviced and returned to you as quickly as possible.

For more details on BMW Ultimate Service, visit your authorized BMW center or log on to [bmwusa.com/ultimateservice](http://bmwusa.com/ultimateservice).



## JOY COMES IN MANY FORMS.

**BMW Virtual Center.** If you get the sudden urge to shop for a BMW but your BMW center is closed, there's good news – the BMW Virtual Center is open 24 hours a day! Log on to [bmwusa.com](http://bmwusa.com), then click on the model series you are interested in. After selecting the BMW that interests you, click on "Build Your Own." Configure the BMW of your dreams, and see what the monthly payments would be. You can even send the specifications to your authorized BMW center, apply for financing, or request a test drive – all online!

**BMW Financial Services.** Arranging to buy or lease a BMW is easier than you may think. Your authorized BMW center offers leasing and financing to suit your personal needs through BMW Financial Services.<sup>5</sup> Start the process at our website, where you can build your "dream vehicle," get an estimate on a monthly lease or financing payment, submit a credit application to BMW Financial Services – and get approval – all online!<sup>6</sup> To find out how BMW Financial Services can help put you behind the wheel of your favorite BMW model, log on to [bmwusa.com/dfs](http://bmwusa.com/dfs) or call, toll-free, **1-800-578-5000**.

**BMW Publications in "Media Gallery & Library."** Sent to new owners and lessees several times a year, **BMW Magazine** is a fascinating view of the latest events and products in the world of BMW, including personality profiles, travel reviews, and the latest BMW technologies. You can read articles from **BMW Magazine** on the BMW website at [bmwusa.com](http://bmwusa.com) under the "Media Gallery & Library" heading, found in the "Experience" section. Here, you can also view featured videos and images, read recent news articles, and download BMW wallpapers. While you're there, check out the "News Feed" area to enjoy articles from **Inside Track**. For more information, call Customer Assistance at **1-800-334-4BMW (4269)** or visit BMW online at [bmwusa.com](http://bmwusa.com).

The new **BMW Welt** ("BMW World") delivery and brand-experience center in Munich is bold proof of BMW's passion for design. When you take advantage of the BMW European Delivery Program,<sup>6</sup> this is where you will meet your new BMW – in a personalized process that is highly dramatic and totally unforgettable. (You might also realize substantial savings that just may pay for your trip.) While you're there, marvel at the historic BMWs in the Museum; learn about our engineers' newest innovations in the Technology and Design Atelier; and take a tour of the plant to experience firsthand the state-of-the-art methods used to create a BMW. Then comes the unique experience of driving your new BMW on the roads it was designed for. To learn more, visit [bmwusa.com/europeandelivery](http://bmwusa.com/europeandelivery).

<sup>1</sup> The BMW Assist and Bluetooth Hands-free Calling system with 4 years of Safety Plan services is optional or included in the Premium Package. In order to receive BMW Assist services, a subscriber agreement must be completed and transferred to the BMW Assist Response Center. GPS and underlying wireless services must be available and functioning; vehicle ignition must be turned on (except for Door Unlock and Stolen Vehicle Recovery), battery charged and connected and vehicle's electrical system operational; services may be limited to certain geographic areas. Call toll-free **1-888-333-6118**, go to [bmwassist.com](http://bmwassist.com), or visit your BMW center for additional program details. Services are subject to the terms and conditions of your subscriber agreement.

<sup>2</sup> See your authorized BMW center for details on these limited warranties.

<sup>3</sup> The BMW Maintenance Program covers factory-recommended maintenance services as determined by the Service Interval Indicator for all new eligible MY 2004 and later BMW vehicles. Specific additional items that need replacement due to normal wear and tear are also covered. The maintenance coverage period is for the first 4 years or 50,000 miles, whichever comes first. Exclusions from coverage include: gasoline, gasoline additives, windshield washer fluid and additives, battery, tires, wheels, wheel alignment and tire balancing. All work must be performed by an authorized BMW center. See the Service and Warranty Information booklet for specific terms, conditions and limitations. Further information can also be obtained from your authorized BMW center.

<sup>4</sup> Requires BMW Assist Safety Plan subscription. Services are subject to the terms and conditions of your subscriber agreement. Please go to [bmwassist.com](http://bmwassist.com) for additional details on the optional Convenience Plan.

<sup>5</sup> Subject to credit approval and other terms and conditions.

<sup>6</sup> Not all models available for BMW European Delivery Program. Please go to [bmwusa.com](http://bmwusa.com) or visit your authorized BMW center for details.



Personalize your 1 Series Coupe with sporty BMW Performance Aerodynamic Kits for the front, doors and rear, shown here with the BMW Performance Carbon Fiber Front Splitter, Carbon Fiber Mirror Caps, and 18-inch alloy wheels.

## EQUIPPED WITH THE BEST IDEAS. ORIGINAL BMW ACCESSORIES.

Driving a BMW is always a special experience – and it can be further enhanced with the wide range of Original BMW Accessories. Benefit from innovative solutions combining striking design and inspired functionality. For example, there's a bicycle rack designed to carry two bicycles, which can easily be folded back to provide access to the trunk. Personalize the exterior with everything from BMW Performance Aerodynamic Kits and Carbon Fiber accessories, to trim options and mud flaps. Make the interior a reflection of your

own style with sporty aluminum pedals, beautiful wood shift knobs, seat covers and more. Every item is designed to BMW's demanding specifications and built to fit the 1 Series Coupe perfectly. To find out more about these and other accessories, contact your preferred authorized BMW center. There you will find a wide selection of quality items, as well as a special brochure detailing the entire range of Original BMW Accessories to fit your 1 Series.

[accessories.bmwusa.com](http://accessories.bmwusa.com)



**BMW Performance Wheels** add aggressive styling and reduce unsprung weight.

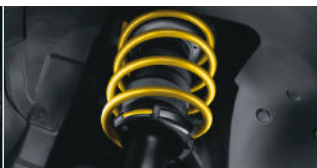

**BMW Performance Suspension** modifies height and spring rates for track-bred handling.



**BMW Performance Carbon Fiber Rear Deck Lid Spoiler** intensifies the look.



**BMW Performance Steering Wheel's** thicker grip provides enhanced control.



**BMW Performance Shift Knob** (manual transmission) combines a high-tech look with non-slip grip.

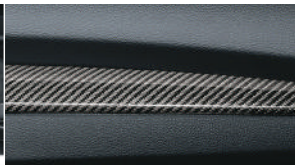

**BMW Performance Carbon Fiber Interior trim** adds a distinctive note.

Some details or items shown in photos may not be available in the United States.

### **BMW and the environment.**

BMW is a strong proponent of the environment and social responsibility. It is important to manage the earth's resources responsibly, and not jeopardize the needs of future generations. That is why BMW makes vehicles that minimize adverse environmental impact, from production (pollution prevention and waste minimization at the plant) through owner use (low emissions) to eventual disposal (easy drainability of all fluid-related components and easy neutralization of all pyrotechnic devices).

This effort has been recognized worldwide and, as a result, we are pleased to have received numerous environmental honors. In the U.S., for example, the Environmental Protection Agency accepted BMW's Spartanburg, SC production and manufacturing facility as a charter member of the agency's National Environmental Performance Track. Internationally, BMW AG – the parent company of both BMW of North America and BMW Manufacturing Co., Spartanburg, SC – was the first automotive company to be represented on the Dow Jones Sustainability Group Index, and has remained on the Index ever since. At BMW, we strive for high performance in everything we do.

U.S. Importer: BMW of North America, LLC, Woodcliff Lake, NJ 07677. All illustrations and specifications contained in this brochure are based on the latest product information available at the time of printing. BMW reserves the right to make changes at any time, without notice, in colors, materials, equipment, specifications and models. BMW may, subject to legal requirements, determine the Model Year designation of its vehicles. The Model Year designation on any particular model may be longer or shorter than 12 months. Some vehicles pictured may contain non-U.S. equipment. Some models may be shown with optional equipment. While BMW NA makes all reasonable efforts to provide accurate information in this brochure, there is no guarantee or warranty of accuracy. Furthermore, we do not assume any liability for the accuracy or completeness of information presented. This brochure shall not be used or relied upon as a substitute for information that is available from your BMW center. Further information can be obtained from your authorized BMW center or [bmwusa.com](http://bmwusa.com).

©2010 BMW of North America, LLC. Not to be reproduced wholly or in part without written permission of BMW NA. The BMW name, model names and logo are registered trademarks.

The Bluetooth word mark and logos are owned by the Bluetooth SIG, Inc. and any use of such marks by BMW is under license. iPod and iPhone are registered trademarks of Apple Inc. Other trademarks and trade names are the property of their respective owners.

**BMW recommends** 

More about BMW

bmwusa.com  
1-800-334-4BMW



The Ultimate  
Driving Machine®

