



Innovation that excites

2014 FRONTIER®

NISSAN FRONTIER®

What if your truck could put a smile on your face, confidence in your hands and goose bumps all over? Here are just a few ways Frontier® gives you an unforgettable drive.

Start with strength. A full-length, fully boxed ladder frame means full-size toughness in a mid-size truck. Go ahead and dish it out. Frontier® can take it.

Lock it down. The first of its kind, Frontier®'s available Utili-track® system has five channels and four heavy-duty cleats to put your cargo on lockdown. And keep it there.*

Proceed with power. 261 HP. 281 lb-ft of torque. Tow it, carry it, move it out. You won't find a more powerful V6 in a mid-size truck.

Looking for more? Visit Frontier® on Facebook® or Twitter® to see what owners have to say. Find walkarounds, product demos and more on YouTube®.

And follow Nissan Canada on:



Innovation that excites

visit nissan.ca

*Cargo and load capacity limited by weight and distribution. Always secure all cargo. Facebook® is a registered trademark of Facebook, Inc. Twitter® is a registered trademark of Twitter, Inc. YouTube® is a registered trademark of Google Inc. All illustrations, photographs and specifications in this brochure are based on the latest product information. See actual vehicle for complete accuracy. Nissan Canada Inc. reserves the right to make changes at any time, without notice, in prices, colours, materials, equipment, specifications and models, and to discontinue models or equipment. For information on additional options and accessories, contact your Nissan Dealership. Registered trademarks are property of their respective owners. At nissan.ca, you'll find virtual product demonstrations, a way to "build your own Nissan," a dealer locator, and more information about key Nissan support services. The Nissan names, logos, product names, feature names, and slogans are trademarks owned by or licenced to Nissan Motor Co. Ltd. and/or its North American subsidiaries. Always wear your seat belt, and please don't drink and drive. Printed in October 2013. Catalogue number: 99999-FRO14EN. © 2013 Nissan Canada Inc. All rights reserved.

WHAT IF

TOUGH WAS ALWAYS ON CALL?

Got a major to-do list? No problem. With Frontier,[®] you've got a partner that's up to the biggest challenges. It's a mid-size truck with full-size attitude, and plenty of engine muscle and towing capacity to get the job done. A fully boxed ladder frame and advanced off-road technology come standard, so no matter what you're doing, you can get there easily. King Cab[®] or Crew Cab, there's plenty of room for work and play. And with the PRO-4X[®] model, you choose when to cut a trail from the highway to the hills. The 2014 Nissan Frontier.[®]



CAPABILITY IS IN YOUR CORNER.

Power – either you've got it, or you don't. And with Frontier,[®] you've got it in a big way. With an available 4.0-litre engine packing 261 horsepower, you won't find a more powerful V6 in its class.¹ And with a massive 281 lb-ft of torque, you can tow or haul just about anything you need to bring along. Maybe it's because we're a company that loves to compete – off-road, on the racetrack, even in the showroom. But wherever we win, we're happy to share the prize with you.

261
HORSEPOWER

281
LB-FT OF TORQUE

6500
LBS (2948 KG) MAX TOWING²

Nissan Frontier[®] SV V6 King Cab[®] shown in Brilliant Silver with optional equipment.



A 4-cylinder that feels like a 6. Frontier[®] also offers a 2.5-L 4-cylinder that pumps out 152 horsepower, 171 lb-ft of torque and features a compact balancer system to deliver the smoothness of a V6.

Gear up. You can harness the 4-cylinder's power through a 5-speed manual transmission or an available 5-speed automatic. The V6 is available with either a 6-speed manual or 5-speed automatic transmission.

¹Association of International Automobile Manufacturers of Canada (AIAMC) Small Pickup Segmentation. ²King Cab[®] 4x2 models with V6. 7-pin connector trailer wire harness and tow hitch receiver required. See Nissan Towing Guide and Owner's Manual for proper use. ³Automatic transmissions only. Cargo and load capacity limited by weight and distribution. Always secure all cargo. BFGoodrich[®] is a registered trademark of Goodrich Corporation. Bilstein[®] is a registered trademark of ThyssenKrupp Bilstein GmbH. Rugged Trail[®] T/A is a registered trademark of Uniroyal Goodrich Licensing Services, Inc.

TREAT 'EM LIKE PEBBLES.

The ultimate off-road Frontier,[®] the PRO-4X[®] Exhibit championship form with unrivaled gear, including Bilstein[®] off-road performance shocks, an electronic locking rear differential, 4-wheel Active Brake Limited Slip (ABLS), skid plates and 265/75R16 BFGoodrich[®] Rugged Trail T/A[®] tires. Add in unique 16" 6-spoke alloy wheels, halogen fog lights and an exclusive interior, and you've got a winning combination, inside and out.

PRO-4X[®]

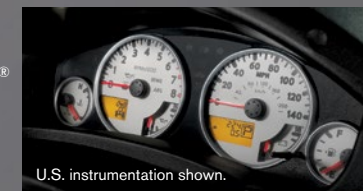

Hill start assist. When starting on steep hills from a stop, hill start assist will help keep you from rolling backwards. It holds brake pressure for a few seconds, allowing you enough time to switch from the brake pedal to the accelerator.³

Hill descent control. When driving down a steep grade in 4WD, hill descent control can help. Just flip the switch, ease your foot from the accelerator, and this system automatically maintains speed and brake pressure to help provide a controlled descent.³

Electronic locking rear differential. When 4x4 mode just isn't enough, press the switch to activate the electronic locking rear differential. This ultimate off-road feature delivers equal power to both rear wheels to boost traction and help keep your truck moving forward. When engaged, it works in conjunction with the 4-wheel Active Brake Limited Slip (ABLS). So while the locking rear differential keeps the rear wheels powered to move you ahead, ABLS helps give you the traction you need up front to help maintain steering control.



Nissan Frontier PRO-4X[®] King Cab[®] shown in Lava Red.

NISSAN KNOWS THAT FOUR WALLS ARE STRONGER THAN THREE.

That's why Frontier® features a full-length, fully boxed ladder frame instead of the 3-sided, open C-shape rails found on some other trucks. The frame is built with super-high-tensile-strength steel in strategic areas for improved structural rigidity. This rugged material is stronger than conventional steel, for increased torsional stiffness that ultimately delivers enhanced performance, on- and off-road. And it's the perfect foundation to build upon with our advanced technology.



FULLY BOXED FRAME



CONVENTIONAL C-RAIL

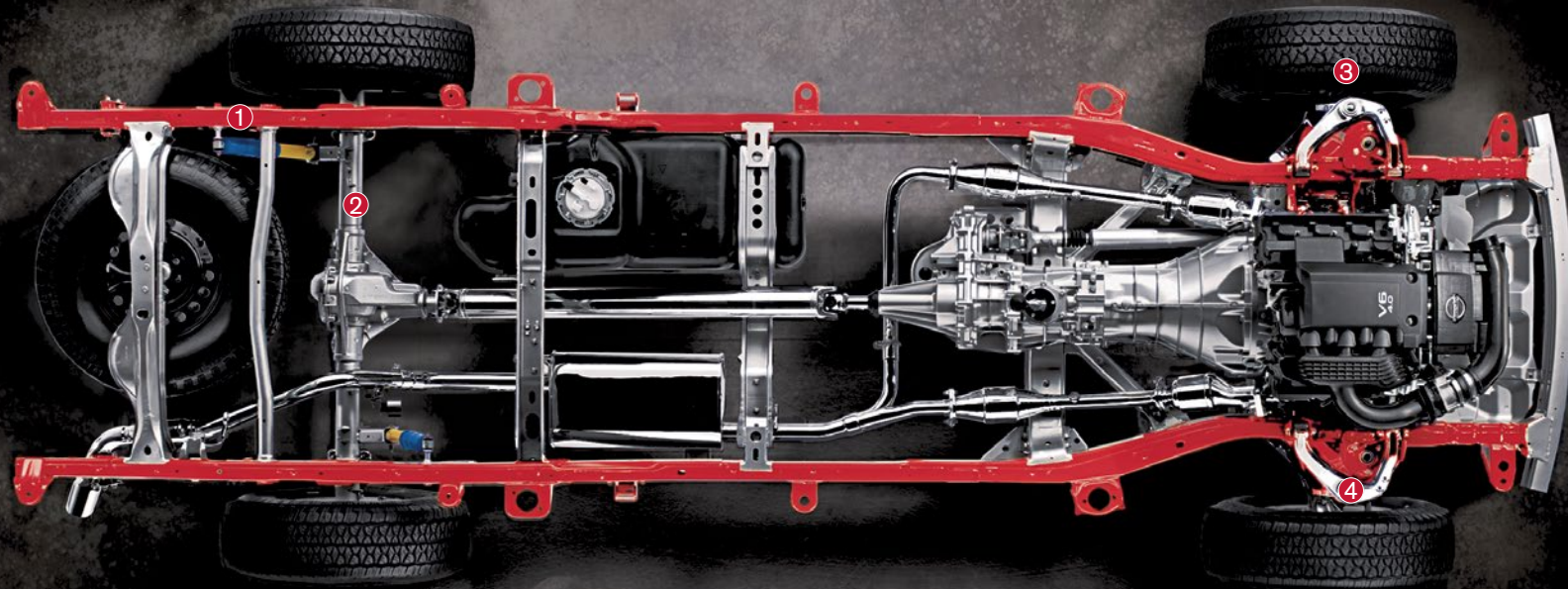

① Overslung rigid leaf-spring rear suspension

② Available heavy-duty Dana® rear axle

③ 4-wheel vented disc brakes with Anti-lock Braking System (ABS)

④ Steel double-wishbone front suspension

Anti-lock Braking System (ABS) rapidly pumps the brakes during hard braking to help keep your wheels from locking up, thus helping you to steer around an obstacle.

Electronic Brake force Distribution (EBD) senses additional weight, whether it's a full cargo bed or a full tank of gas, and sends extra force to the rear brakes.

Brake Override Technology. On every Frontier®, it's designed to help slow down your vehicle and bring it to a safe stop in an emergency. It works by overriding accelerator input and reducing engine power when the accelerator and brake pedals are applied simultaneously.

Vehicle Dynamic Control (VDC):¹ Also known as electronic stability control, VDC monitors driver inputs and vehicle motion and helps compensate for oversteer or understeer to help keep you on your intended path.

Active Brake Limited Slip (ABLS). To help keep your wheels from spinning, Frontier® offers ABLS. This system senses when a wheel begins to slip, then automatically brakes the slipping wheel (or wheels) and sends additional power to the wheels with the best traction.

NISSAN UTILI-TRACK® SYSTEM INNOVATION THAT'S GOT A GRIP.

Wouldn't it be cool if you could put the submission hold on cargo? The available Utili-track® Channel System on Frontier® gives you choices few other trucks can match. Just about any type of cargo you can think of, this available system is fully equipped to help keep it secured tightly. Five channels, four cleats and a lot of thought about how people really use their trucks have created a system that's simple, rugged and offers near-infinite possibilities.



4 CLEATS

Frontier's four heavy-duty forged aluminum cleats easily slide in the channels for unmatched flexibility to tie things down – and the strength to hold them.

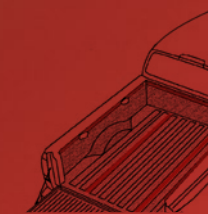

5 CHANNELS

Unmatched versatility comes in the form of five channels – including two channels in the floor, a feature few competitors can match. And since you can lock the cleat anywhere along the rail, Frontier® makes sure you find the best position to secure whatever you bring along.



SPRAY-ON BEDLINER

Adding to the incredible versatility of the bed, the available spray-on bedliner is applied at the factory – so you know it's done right. Fade- and weather-resistant, it's a rugged, non-skid surface that adheres directly to the bed to help prevent rusting.



LOADS OF ACCESSORIES

There's also a full line of accessories to help you get even more out of Utili-track®, including a Sliding Tool Box,² a Sliding Bed Divider and a Sliding Bed Extender.



¹VDC, which should remain on when driving except when freeing the vehicle from mud or snow, cannot prevent accidents due to abrupt steering, carelessness, or dangerous driving techniques. Always drive safely. ²Tool Box Tray shown in photo is sold separately. See your Nissan dealer for more information. Dana® is a registered trademark of Dana Corporation. Some components have been chrome-plated or painted for display purposes only.

Cargo shown for display purposes only. Nissan recommends that all loose items be secured when transported. Cargo and load capacity limited by weight and distribution.

FRONTIER® CREW CAB.

Space, or comfort? Why not both? Forward-hinged doors make for easy entry, while a 60/40 split rear bench allows seating for five and folds easily to create a large, flat surface. Or you can flip up the rear seat cushions for more storage room. There's also an under-seat storage tray that's removable for even greater flexibility.

FOLDS FLAT

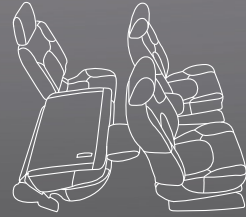

FLIPS UP

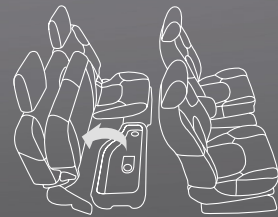

FRONTIER® KING CAB.®

Smart design means rear doors that give your passengers easy access to the cabin. And with no B-pillars, you also get a huge opening for larger-than-life items. The two rear seats flip up and out of the way to reveal a large open space for cargo. You can even fold down the front passenger seat to carry larger items, or to make a flat writing surface.



Nissan Frontier® SL Crew Cab shown in Steel Leather.



Nissan Frontier® PRO-4X® King Cab® shown in Graphite Steel Cloth.

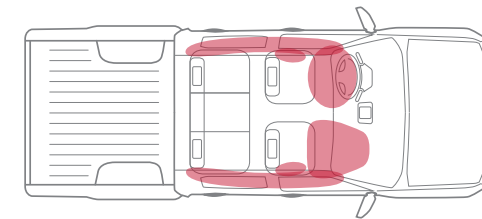

6 STANDARD AIRBAGS¹

Safety. First and foremost. In Frontier®, making your protection our priority starts with six standard airbags, including seat-mounted side-impact supplemental airbags and roof-mounted curtain side-impact supplemental airbags. The advanced front seat belts on every Frontier® feature pre-tensioners that automatically help tighten the belts when the front airbags deploy.¹ And if your body puts too much force on the belt, load limiters give a bit. During a rear-end impact, front-seat Active Head Restraints move up and toward you to meet your head part of the way, helping close the gap and reducing the chance of whiplash.

¹Airbags are only a supplemental restraint system; always wear your seat belt. Even with the occupant-classification sensor, rear-facing child restraints should not be placed in the front-passenger's seat. Also, in addition to any other requirement of applicable law, all children 12 and under should ride in the rear seat properly secured in child restraints, booster seats, or seat belts according to their size. And please see your King Cab® Owner's Manual for specific information about the safest way to secure a child restraint in a Frontier® King Cab®. Airbags will only inflate in certain accidents; see your Owner's Manual for more details. Inflated airbags shown for illustration purposes only, actual coverage area may differ. Airbags deflate after deployment.



U.S. instrumentation shown.

BRING THE MAN CAVE WITH YOU.

Comfort? Entertainment? Cup holders? Check, check and check. Whether you're on the job or on the go, Frontier® gives you everything you need to make your space, well, yours. A great-looking interior plus an available leather-wrapped steering wheel with controls to operate the cruise control and audio – all the better to crank up the available Rockford Fosgate®-powered audio system. Available Dual Zone Automatic Temperature Control (ATC) so you and your passenger can set your own climates. And with the available Nissan Navigation System with 147 mm (5.8") touch-screen display, you can plan your next adventure without ever leaving the driver's seat.¹ If only everything were so convenient.



Check surroundings for safety.

What if you could see objects behind you when parking? The available RearView Monitor³ automatically activates whenever you're in reverse, making it ideal for lining up your approach to a trailer. Now that's handy.



Your tunes sound better through an available Rockford Fosgate®-powered audio system, featuring 10 speakers, including subwoofers, and SiriusXM® Satellite Radio.²



The standard Bluetooth® Hands-Free Phone System lets you make and take calls with your hands on the wheel and listen to calls through the audio system's speakers.⁴

CHOOSE YOUR TRIM LEVEL

S KING CAB®

Features 152 HP 2.5-litre 4-cylinder engine mated to a 5-speed manual or a 5-speed automatic, engine block heater, 4-wheel disc brakes with ABS, Active Brake Limited Slip (ABLS), Vehicle Dynamic Control (VDC), Traction Control System, rear access doors, upper body-colour/lower black front bumper and chrome rear bumper, privacy glass, fold-flat front passenger seat, forward-facing rear flip-up seats, AM/FM/CD audio system, air conditioning, cruise control, Bluetooth® Hands-Free Phone System,⁴ illuminated steering wheel-mounted audio controls, Tire Pressure Monitoring System (TPMS),⁹ carpeted floor mats and six standard airbags. **Key available package:** S Value Package. This trim level is available in 4x2 only.



SV KING CAB® CREW CAB INCLUDES S EQUIPMENT PLUS:

261 HP 4.0-litre V6 engine with a 5-speed automatic transmission, Active Brake Limited Slip (ABLS), 16" aluminum-alloy wheels, front tow hook (4x4 models only), body-colour front bumper, AM/FM/CD audio system with 109 mm (4.3") colour display, USB connection port,² SiriusXM® Satellite Radio,² anti-theft system and Immobilizer Key System. 4x4 automatic transmission models also include hill descent control and hill start assist. **Crew Cab adds:** Four full front-hinged doors, 60/40 split rear bench, full-length rear under-seat storage, two additional speakers. **Key available package:** SV Premium Package (4x4 models only).



PRO-4X® KING CAB® CREW CAB INCLUDES SV EQUIPMENT PLUS:

6-speed manual transmission (King Cab® only), PRO-4X® Bilstein® shocks, electronic locking rear differential, skid plates, P265/75R16 BFGoodrich® Rugged Trail T/A® OWL tires, 16" aluminum-alloy off-road wheels, High Utility Bed, fog lights, satin chrome grille, splash guards, body-colour front and rear bumpers, door handles and outside mirrors, RearView Monitor,³ Rear Sonar System, auto-dimming rearview mirror, digital compass and outside temperature display, multi-function trip computer, Dual Zone Automatic Temperature Control (ATC), PRO-4X® embroidered cloth seat trim, heated front seats, white contrast interior stitching, white-faced gauges. **Crew Cab adds:** Roof rack with crossbars, power sliding glass moonroof and Rockford Fosgate®-powered audio system. **Key available package:** PRO-4X® Leather Package. This trim level is available in 4x4 only.



SL CREW CAB INCLUDES SV EQUIPMENT PLUS:

5-speed automatic transmission, 18" aluminum-alloy wheels, fog lights, chrome front bumper, roof rack with crossbars, step rails, power sliding glass moonroof, chrome door handles and outside mirrors, NissanConnect™ with Navigation,^{1,5} RearView Monitor,³ Rear Sonar System, Dual Zone Automatic Temperature Control (ATC), auto-dimming rearview mirror with HomeLink® universal garage-door opener, Rockford Fosgate®-powered audio system, 8-way power adjustable driver's seat, 4-way power adjustable passenger's seat, leather seating surfaces, heated front seats, leather-wrapped steering wheel. This trim level is available in 4x4 only.



¹Factory-installed option. Never program while driving. GPS mapping may not be detailed in all areas or reflect current road regulations. ²XM® and SiriusXM® Satellite Radio is available in the 10 Canadian provinces and the 48 contiguous United States. Basic monthly subscription required and sold separately after trial period. SiriusXM® Traffic is available in select North American markets. In Canada, at time of printing, incident and flow data is available for 7 metropolitan areas of Canada (Vancouver, Calgary, Edmonton, Toronto, Ottawa, Montreal and Quebec City). Limited flow data is available for Toronto. Subscription sold separately after trial period. All subscriptions subject to customer agreement at siriusxm.ca/terms. All fees and programming subject to change. © 2013 Sirius XM Canada Inc. The Sirius®, XM® and SiriusXM® names and all related marks and logos are trademarks of Sirius XM Radio Inc. All other trademarks are the property of their respective owners. ³Parking aid/convenience feature. Cannot completely eliminate blind spots or warn of moving objects. May not detect every object. Always check surroundings before moving vehicle. Not a substitute for proper backing procedures. Always turn to check what is behind you before backing up. ⁴Availability of specific features is dependent upon the phone's Bluetooth® support. Please refer to your phone Owner's Manual for details. The Bluetooth® word mark and logos are owned by Bluetooth SIG, Inc., and any use of such marks by Nissan is under licence. ⁵Late availability. Driving is serious business. Only use NissanConnect™ services when safe to do so. Subscription Agreement required. Compatible smartphone required. Not all app features are available for all models. Some apps have late availability. May require dealer service visit or software upgrade to activate. Never program while driving. GPS mapping may not be detailed in all areas or reflect current road regulations. Cellular network not available in all areas. Cellular network, apps, and services, including Google® services, are provided by independent companies not within Nissan's control and may require subscription and owner consent to activate. Should provider terminate/restrict service, service may be terminated without notice or liability to Nissan and/or its agents. Nissan not responsible for any equipment or app replacement/upgrades, or associated costs, that may be required for continued operation. Terms and conditions of Subscription Agreement apply. 36-month trial period starts on vehicle sale date; subsequently a paid subscription is required at the then current rate. Standard text rates and/or data usage may apply. See retailer and check www.Nissan.ca/NissanConnect for details. ⁶Driving is serious business and requires your full attention. Do not operate any devices connected to the USB or auxiliary audio input jack while driving. ⁷Driving is serious business and requires your full attention. Even with hands-free text messaging assistant, only use car features displayed when safe. ⁸Tire Pressure Monitoring System is not a substitute for regular tire pressure checks. BFGoodrich® is a registered trademark of Goodrich Corporation. Bilstein® is a registered trademark of ThyssenKrupp Bilstein GmbH. Facebook® is a registered trademark of Facebook, Inc. Google® is a registered trademark of Google Inc. HomeLink® is a registered trademark of Johnson Controls Technology Company. iPod® is a registered trademark of Apple, Inc. All rights reserved. iPod® not included. Rockford Fosgate® is a registered trademark of Rockford Corporation. Rugged Trail T/A® is a registered trademark of Uniroyal Goodrich Licensing Services, Inc. Slacker® is a registered trademark of Slacker, Inc. Stitcher® is a registered trademark of Stitcher, Inc. Tuneln™ Radio is a trademark of Tuneln Inc. Yelp® is a registered trademark of Yelp Inc.

NISSANCONNECT™5

INNOVATION YOU'LL FIND INCREDIBLY HANDY.

NissanConnect™ is smart technology that keeps your world within reach. And with NissanConnect™ Apps, your Frontier® becomes your smartphone's best friend. Music, information and the apps that keep you connected to your world all work seamlessly together through Frontier®'s audio system. And it keeps on getting better: the app alerts you with updates to the latest version, and the basic app package is free for the first three years.⁵

NissanConnect™ Apps: for the music you love.⁵ Imagine the choices you have with Tuneln™ Radio, Stitcher®, Slacker® and more. And it couldn't be easier – download the app, and depending on your smartphone, you can stream the music wirelessly via Bluetooth® or use Frontier®'s iPod®/USB input.^{4,6} You can find out how to download the app and about smartphone compatibility at www.Nissan.ca/NissanConnect.

NissanConnect™ Apps: everything that matters at your fingertips.⁵ You're wired to your world with NissanConnect™ Apps. Frontier® lets you safely keep track of Facebook® and more. And thanks to Frontier®'s available navigation system and NissanConnect™'s compatibility with location-based services including Online Search powered by Google® and Yelp®, getting around has never been easier!^{1,5} (Go to the Owners' section of www.Nissan.ca/NissanConnect for details on downloading the app, smartphone compatibility and late availability of certain apps.)

More than just apps, NissanConnect™ keeps you in the loop with:

- Nissan Navigation System – with voice recognition featuring one-shot destination entry and SiriusXM® Traffic^{1,2}
- iPod®/USB input – search for a tune with enhanced voice recognition⁶
- Streaming audio via Bluetooth®⁴
- Hands-free text-messaging assistant⁷



PAINT AND FABRIC

- Standard
- Part of PRO-4X® Leather Package

¹Extra cost option

²Crew Cab only

³King Cab® only

Nissan has taken care to ensure that the colour swatches presented here are the closest possible representations of actual vehicle colours. Swatches may vary slightly due to the printing process and whether viewed in daylight, fluorescent or incandescent light. Please see the actual colours at your local Nissan dealer.



Glacier White QAK

Brilliant Silver¹ K23

Metallic Blue¹ B17

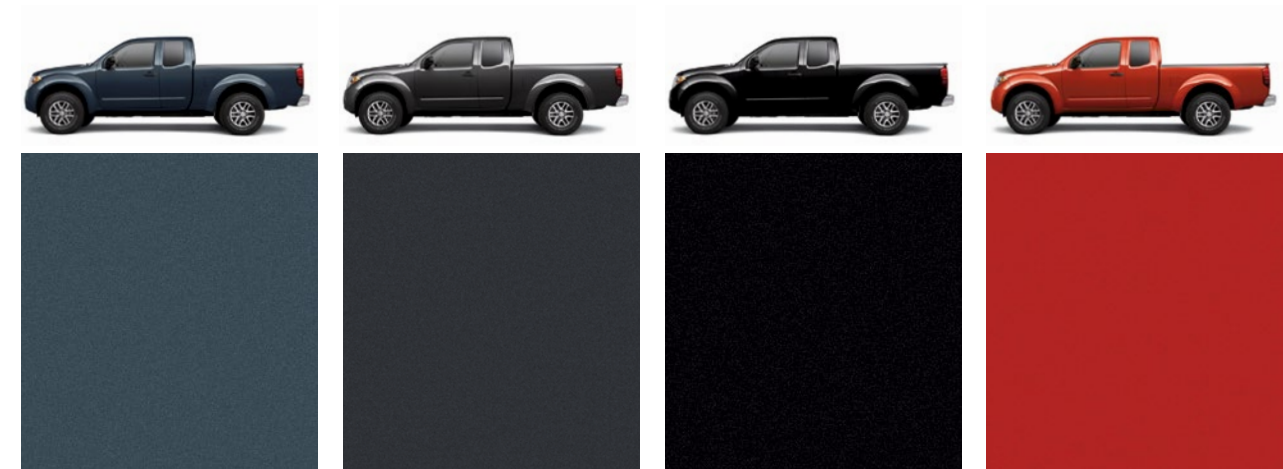

Graphite Blue¹ RAQ

Night Armour¹ K26

Super Black KH3

Lava Red¹ EAF

	S	SV	PRO-4X*	SL
STEEL CLOTH	■	■ ²		
STEEL LEATHER				■
BEIGE CLOTH		■		
BEIGE LEATHER				■
GRAPHITE CLOTH		■ ³		
GRAPHITE STEEL CLOTH			■	
GRAPHITE LEATHER			□ ²	

	S	SV	PRO-4X*	SL
STEEL CLOTH	■	■ ²		
STEEL LEATHER				■
BEIGE CLOTH				
BEIGE LEATHER				
GRAPHITE CLOTH	■	■ ³		
GRAPHITE STEEL CLOTH			■	
GRAPHITE LEATHER			□ ²	

	S	SV	PRO-4X*	SL
STEEL CLOTH		■ ²		
STEEL LEATHER				■
BEIGE CLOTH		■		
BEIGE LEATHER				■
GRAPHITE CLOTH		■ ³		
GRAPHITE STEEL CLOTH			■	
GRAPHITE LEATHER			□ ²	

	S	SV	PRO-4X*	SL
STEEL CLOTH		■ ²		
STEEL LEATHER				■
BEIGE CLOTH		■		
BEIGE LEATHER				■
GRAPHITE CLOTH		■ ³		
GRAPHITE STEEL CLOTH			■	
GRAPHITE LEATHER			□ ²	

	S	SV	PRO-4X*	SL
STEEL CLOTH		■ ²		
STEEL LEATHER				■
BEIGE CLOTH		■		
BEIGE LEATHER				■
GRAPHITE CLOTH		■ ³		
GRAPHITE STEEL CLOTH			■	
GRAPHITE LEATHER			□ ²	

	S	SV	PRO-4X*	SL
STEEL CLOTH	■	■ ²		
STEEL LEATHER				■
BEIGE CLOTH		■		
BEIGE LEATHER				■
GRAPHITE CLOTH	■	■ ³		
GRAPHITE STEEL CLOTH			■	
GRAPHITE LEATHER			□ ²	

	S	SV	PRO-4X*	SL
STEEL CLOTH		■ ²		
STEEL LEATHER				■
BEIGE CLOTH		■		
BEIGE LEATHER				■
GRAPHITE CLOTH		■ ³		
GRAPHITE STEEL CLOTH			■	
GRAPHITE LEATHER			□ ²	



STEEL CLOTH
S King Cab®



BEIGE CLOTH
SV King Cab®



BEIGE CLOTH
SV Crew Cab



GRAPHITE STEEL CLOTH
PRO-4X® models

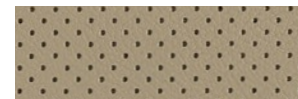

BEIGE LEATHER
SL Crew Cab



GRAPHITE CLOTH
S King Cab®



GRAPHITE CLOTH
SV King Cab®



STEEL CLOTH
SV Crew Cab



GRAPHITE LEATHER
PRO-4X® Crew Cab



STEEL LEATHER
SL Crew Cab

GENUINE NISSAN ACCESSORIES

Every Genuine Nissan Accessory is: custom-fit, custom-designed and durability-tested; backed by Nissan's 3 year/60,000 km Accessories limited warranty; and can be financed when installed by dealer at time of purchase.⁴

A. Fog Lights

Help light your way in rain, sleet or snow.

B. Non-sliding Tool Box

Like a treasure box for your tools.

C. All-season Rubber Floor Mats

Don't let the muck mess up your truck.

D. Weight-distributing Ball Mount, Class IV⁵

So you can tow and go.

Additional Accessories:

- Body Side Mouldings
- Step Rails
- Hood Deflector
- Side-window Deflectors
- Carpeted Floor Mats
- PRO-4X® Carpeted Floor Mats
- Tow Hitch Receiver, Class IV⁵
- Splash Guards
- Sliding Bed Extender
- Sliding Bed Divider
- Sliding Tool Box
- Bed Tent
- And More



See your Nissan dealer for details, or go to accessories.nissan.ca

BUYING AND OWNING

Finance Options Through Nissan Canada Finance, we offer many attractive purchase and lease programs, all with competitive rates and terms. With our flexible finance options, driving home a new Nissan has never been easier. Consult your local Nissan Dealership for complete details.

No-Nonsense Warranty Every 2014 Nissan is covered by a 3 year/60,000 km⁶ Comprehensive New Vehicle Warranty, a 5 year/100,000 km⁶ Powertrain Warranty, an 8 year/130,000 km⁶ Emission Control Warranty on selected components, and a 5 year/unlimited km Corrosion Perforation Warranty. As a Nissan owner, you'll also receive a 3 year Roadside Assistance program available to you 24 hours a day. Terms, conditions and exclusions apply. See Warranty Information Booklet for complete details.

Added Security Plan (ASP) For ultimate peace of mind, consider the Nissan Added Security Plan. It's our commitment to be there for you, and to help you leave your worries behind. Different plans, available for both purchased and leased vehicles, let you tailor the coverage to your driving habits.

Security+Plus™ Prepaid Maintenance Plan The smart choice when it comes to maintaining your new Nissan. Honoured at all participating Nissan Dealers in Canada and the U.S., your vehicle is cared for by factory-trained technicians using Genuine Nissan Parts. And best of all, there's no worrying about price increases on parts or service in the future. A variety of plans are available. Ask your Dealer for details.

Nissan's environmental action plan focuses on several key areas. Increasing production of Zero Emission vehicles, including the 100% electric LEAF.™ Improving fuel efficiency through our PUREDRIVE™ measures. And reducing the environmental impact of manufacturing, as seen at our new, energy-efficient, low-emissions paint plant in Tennessee.



⁴See your Nissan Dealership and read the actual limited warranty. ⁵See Nissan Towing Guide and Owner's Manual for proper use. ⁶Whichever occurs first.

