



2015
TITAN[®]

Innovation
that excites

NISSAN TITAN[®]

What if your truck could put a smile on your face, confidence in your hands and goose bumps all over? That would be cool. Here are just a few ways Titan[®] gives you an unforgettable drive.

Muscle to flex. Titan[™]'s powerful 5.6-litre V8 lets you bring everything you need along, with up to 9400 lbs. (4264 kg) of towing capacity.¹

Easy access. Nissan was the first to perfect the Wide Open rear door design you find on King Cab.[®] It makes getting in or loading up a snap.

A revolutionary bed. Titan[™]'s first in class Utili-track[®] system changed truck beds forever, giving you a whole new way to lock down your cargo.^{2,3}

Looking for more? Visit Titan[®] on Facebook[®] or Twitter[®] to see what owners have to say. Find walkarounds, product demos and more on YouTube.[®]

And follow Nissan Canada on:



Innovation
that excites

visit nissan.ca

¹9400 lbs. maximum towing on Titan[®] SV King Cab[®] 4x4. See Nissan Towing Guide and Owner's Manual for proper use. ²Global Automakers of Canada (GAC). Large Pickup Segmentation. ³Cargo and load capacity limited by weight and distribution. Always secure all cargo. Heavy loading of the vehicle with cargo, especially on the roof, will affect the handling and stability of the vehicle. Facebook[®] is a registered trademark of Facebook, Inc. Twitter[®] is a registered trademark of Twitter, Inc. YouTube[®] is a registered trademark of Google Inc.

All illustrations, photographs and specifications in this brochure are based on the latest product information. See actual vehicle for complete accuracy. Nissan Canada Inc. reserves the right to make changes at any time, without notice, in prices, colours, materials, equipment, specifications and models, and to discontinue models or equipment. For information on additional options and accessories, contact your Nissan Dealership. Registered trademarks are property of their respective owners.

At nissan.ca, you'll find a way to "build your own Nissan," a dealer locator, and more information about key Nissan support services. The Nissan names, logos, product names, feature names, and slogans are trademarks owned by or licenced to Nissan Motor Co. Ltd. and/or its North American subsidiaries. **Always wear your seat belt, and please don't drink and drive.** Printed in November 2014. Catalogue number: 99999-TTN16EN. © 2014 Nissan Canada Inc. All rights reserved.

WHAT IF_

EPIC CAME AS STANDARD EQUIPMENT?

Ready to expand your horizons? It's easy in the Nissan Titan.[®] Put your foot down on a powerful standard V8 engine that hits the road with up to 9400 lbs. of towing capacity.¹ And a fully boxed ladder frame and standard 4x4 handle just about any job on the list. While Titan[®]'s cabin and bed give you plenty of room. 2015 Nissan Titan[®]. No matter how epic your plans, it's ready.



Nissan Titan[®] PRO-4X[®] King Cab[®] 4x4 shown in Glacier White.

¹9400 lbs. maximum towing on Titan[®] SV King Cab[®] 4x4. See Nissan Towing Guide and Owner's Manual for proper use.

317^{HP}

385^{LB-FT}
OF TORQUE

9400^{LBS. (4264 KG)}
MAXIMUM
TOWING¹



THE FEELING OF REELING IN THE BIG ONE.

It's always a good haul with a massive 5.6-litre V8. Punch the pedal and the exhaust system growls, while 385 lb-ft of torque kicks in to get the job done. Because this is one place where you don't want to hear about the one that got away.

What's power without torque? Especially the brute force of low-rev torque, i.e., 80% under 1000 rpm and 90% under 2500 rpm. Feel confident – Titan's got it.

Give yourself an efficiency boost. The Nissan Titan features a high-flow intake that maximizes every heaping gulp of air. Molybdenum-coated pistons and microfinished valves cut friction, ramp up smoothness and let revs rise faster.

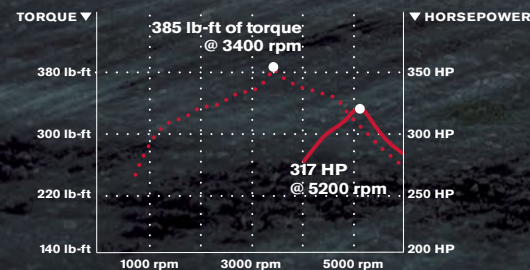

Nissan Titan® SV King Cab® 4x4 shown in Brilliant Silver. 2014 U.S. model shown.

Tow to the max. For that full 9400-lb. (4264 kg) pull, the SV King Cab® 4x4¹ boasts a lower final gear ratio, plus features like extendable tow mirrors and a heavy-duty battery.

THE FEELING OF MAKING MOLEHILLS OUT OF MOUNTAINS.

E-locker. When 4-Wheel Drive LO isn't enough for the crawl you've got planned, the available electronic locking rear differential is ready and extremely able. Flip the switch and this ultimate off-road feature delivers equal power to both rear wheels to boost traction and keep your truck moving forward.

4-Wheel Active Brake Limited Slip (ABLS). Keep your wheels from spinning. Titan® includes ABLS, a system that senses when a wheel begins to slip, then automatically brakes the slipping wheel (or wheels) and sends additional power to the wheel (or wheels) with the best traction.

Vehicle Dynamic Control (VDC). When you're on-road – and paths are better defined – traction and control are key. VDC monitors the truck's dynamic response and helps compensate for oversteer or understeer to help keep you on your steered path.²

Off-road-tuned Suspension. Take the bumps like a professional. Titan® PRO-4X®'s off-road-tuned suspension includes legendary Rancho® shocks for composure through the ugly stuff.

PRO-4X

For those who like to live off-off-off the beaten path, the only choice is Titan® PRO-4X®. With extras like electronic locking rear differential, Rancho® off-road shocks, additional underbody skid plates – not to mention unique white-faced gauges – it's got the gear, the guts, the technology to handle it in places where success is measured in metres per minute.



Nissan Titan® PRO-4X® King Cab® 4x4 shown in Cayenne Red. U.S. model shown.

¹9400 lbs. maximum towing on Titan® SV King Cab® 4x4. See Nissan Towing Guide and Owner's Manual for proper use. ²VDC, which should remain on when driving except when freeing the vehicle from mud or snow, cannot prevent accidents due to abrupt steering, carelessness, or dangerous driving techniques. Rancho® is a registered trademark of Tenneco Automotive Operating Company, Inc.

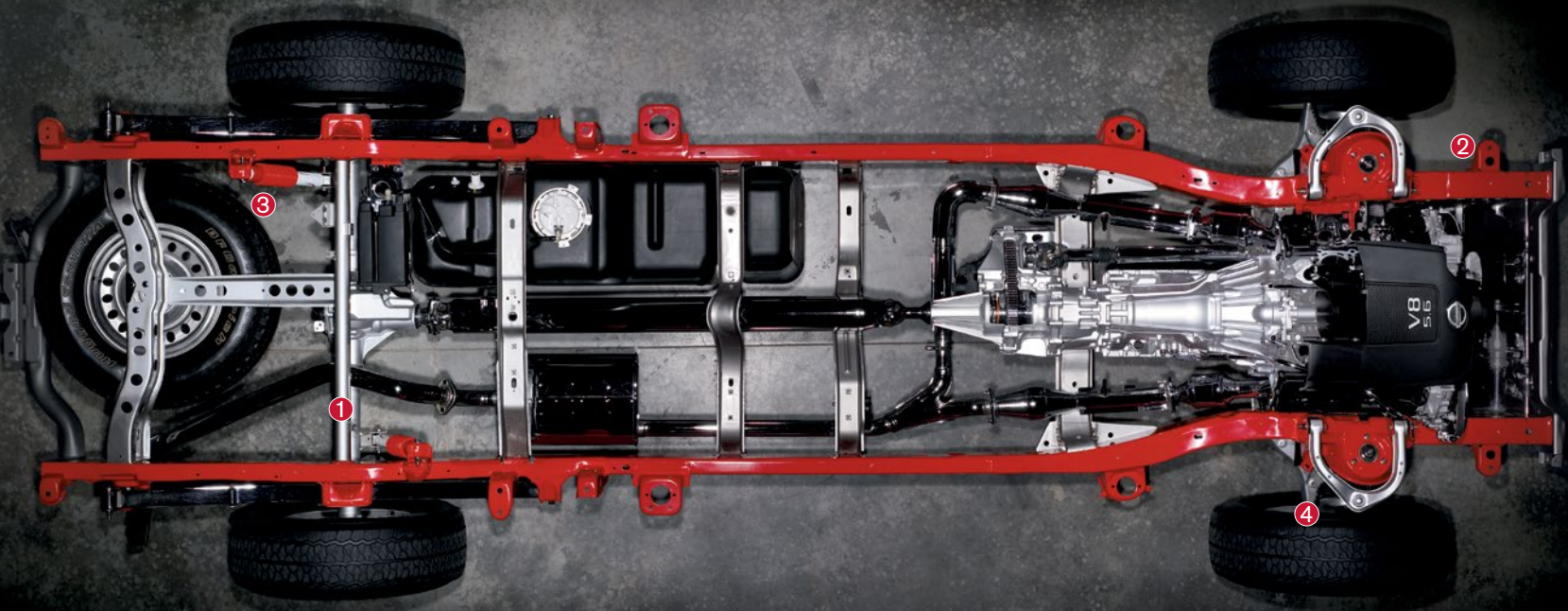

NISSAN UTILI-TRACK®

INNOVATION THAT PUTS THE SUBMISSION HOLD ON CARGO.

Nissan's first-in-class Utili-track® cargo-carrying system holds a huge advantage over other trucks.¹ With five channels, including two on the bed floor, not just in the walls and header, you can have your way with cargo. Just position the four beefy aluminum-alloy cleats anywhere along the tracks, strap in your cargo, and put even the most awkward loads on lockdown.²

Nissan's revolutionary available Utili-track® system may have been copied by others, but its level of flexibility leads the way among full-size trucks. Combined with Titan®'s standard spray-on bedliner, and you've got one smart, long-lasting bed to haul what you need, work or play.²

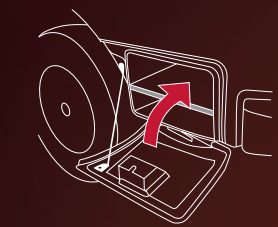

Bedside Storage. Another smart feature you'll only find on Titan®: an available driver-side tool box. It's climate-resistant, dual-level, and lockable.

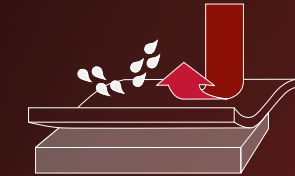

First-in-class Spray-on Bedliner! The spray-on bedliner helps resist the wear and tear of constant use, plus its UV-resistant surface helps guard against fading and the weather. And because it's sprayed on directly at the factory, it also fights warping and rust.

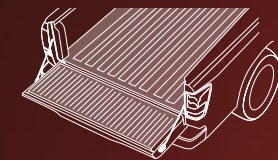

Tailgate Assist. Easy does it. Thanks to an available strut, the tailgate on a Titan® feels lighter and can be opened and closed with only one hand.

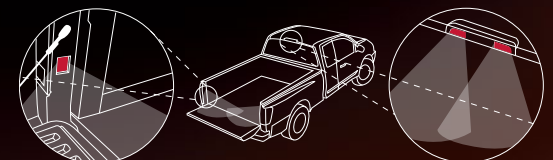

Bed Light and Tailgate Light. Shine a light on innovation. A pair of lights beam down into the bed; two other available task lights near the tailgate help you keep an eye on the job at hand.

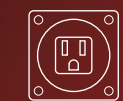

120-volt AC Power. Power where you need it. Titan®'s available 120-V outlet in the driver-side rear corner of the bed is perfect for powering or charging the tools you bring along.

FOUR WALLS ARE STRONGER THAN THREE.

To build a better truck, sometimes you need to think inside the box. As in the fully boxed full-length ladder frame that's at the core of every Titan®. Some of our competitors use 3-sided open "C" rails instead. But you don't need to be a structural engineer to know the obvious – when building, four walls are stronger than three.

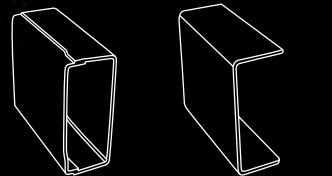

Titan®'s Boxed Frame Conventional C-rail

At its core, every Titan® stocks a fully boxed ladder frame, plus components built for no-nonsense performance.

- ① **Dana® axles** are built for durability. Wherever there's a drive wheel, there's a Dana® axle.
- ② **Heavy-duty suspension** gives a smooth ride and firm, responsive handling. Double-wishbone up front, and multi-leaf springs in the rear.
- ③ **Rancho® shocks** set the standard for off-road toughness. Just what you'd expect from Titan® (exclusive to PRO-4X®).
- ④ **Beefy brakes** provide maximum contact area for rapid heat dissipation, long-lasting durability and confident towing.

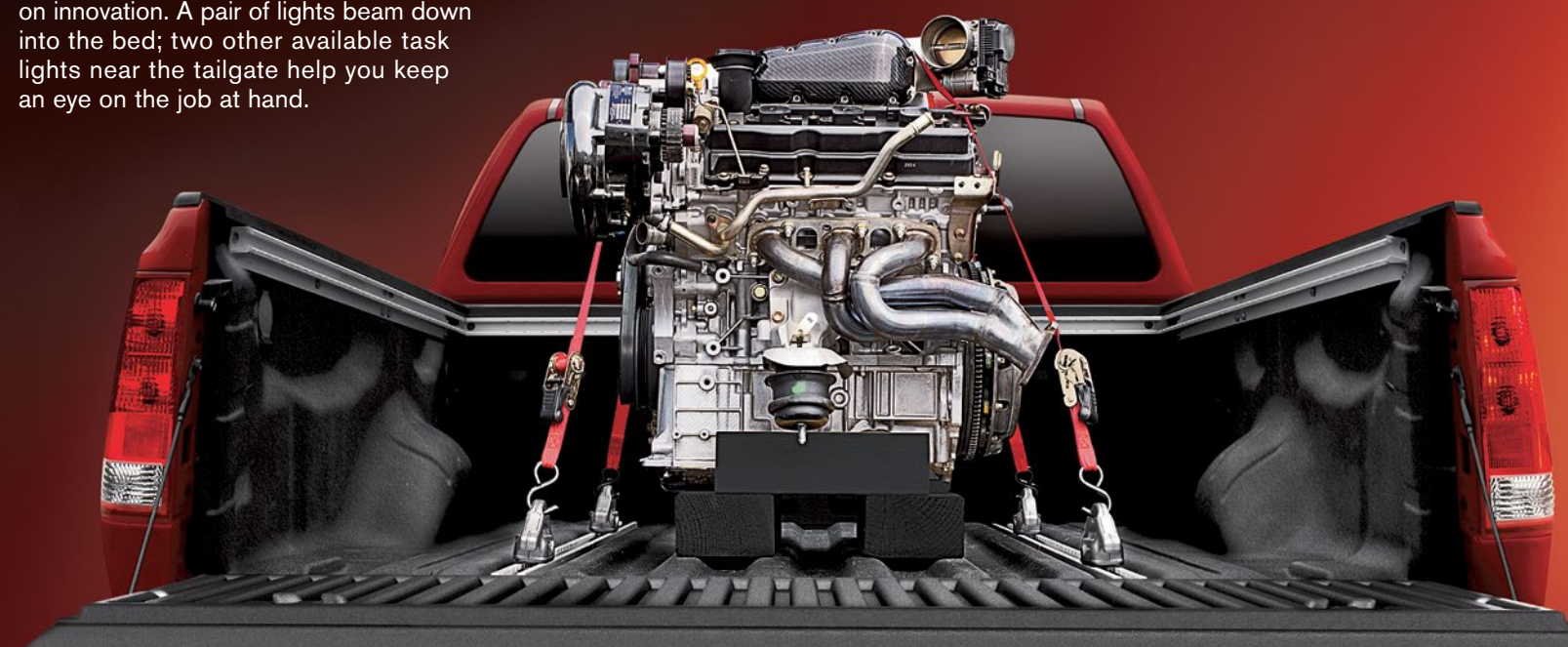

Some components have been chrome-plated or painted for display purposes only. ¹Global Automakers of Canada (GAC). Large Pickup Segmentation. ²Cargo and load capacity limited by weight and distribution. Always secure all cargo. Heavy loading of the vehicle with cargo, especially on the roof, will affect the handling and stability of the vehicle. ®Dana is a registered trademark of Dana Corporaion. ®Rancho is a registered trademark of Tenneco Automotive Operating Company, Inc.



Titan® takes your comfort personally – even if you have to share sometimes. Premium details include a memory function that locks in the perfect settings for your driver's seat, outside mirrors and power adjustable pedals.¹ Dual Zone Automatic Temperature Control (ATC)¹ that lets you and your front passenger set your own climates. And when the temperature dips outside, heated front seats warm things up.¹

Nissan Titan® PRO-4X® Crew Cab 4x4 shown in Charcoal Leather with PRO-4X® Option Package.



RearView Monitor. Titan®'s RearView Monitor not only helps you see what's behind you, but comes in real handy when you're hitching a trailer.^{1,3}



Bluetooth® Hands-Free Phone System lets you make and take calls with your hands on the wheel!^{1,4}



120-volt AC power. A 120-volt outlet means you can charge your laptop while it's safely concealed in the console.¹



10-speaker Rockford Fosgate®-powered audio system, including SiriusXM® Satellite Radio, makes your tunes sound their best.^{1,5}



Nissan Titan® SL Crew Cab 4x4 shown in Charcoal Leather. U.S. instrumentation shown.

NissanConnect^{SM1,2} YOUR WORLD, AT YOUR FINGERTIPS.

With the available NissanConnectSM with Mobile Apps, your Titan® becomes your smartphone's best friend. Which means no more separation anxiety for you. Because now, your own hand-picked music, Facebook® news feed, latest tweets, TripAdvisor® tips, and more all come along for the ride, working seamlessly together through Titan®'s audio system. And it keeps on getting better: the basic app package is complimentary for the first three years.^{1,2}



Your Titan® also keeps you in the loop with the available Nissan Navigation System (featuring voice recognition),⁶ hands-free text messaging,⁷ Bluetooth® hands-free calling and streaming audio,⁴ plus an iPod®/USB input.⁸

¹Available feature. ²Driving is serious business. Only use NissanConnectSM services when safe to do so. Subscription Agreement required. Compatible smartphone required. Not all app features are available for all models. Some apps have late availability. May require dealer service visit or software upgrade to activate. Never program while driving. GPS mapping may not be detailed in all areas or reflect current road status. Cellular network not available in all areas. Cellular network, apps, and services, including Google® services, are provided by independent companies not within Nissan's control and may require subscription and owner consent to activate. Should provider terminate/restrict service, service may be terminated without notice or liability to Nissan and/or its agents. Nissan not responsible for any equipment or app replacement/upgrades, or associated costs, that may be required for continued operation. Terms and conditions of Subscription Agreement apply. 36-month trial period starts on vehicle sale date; subsequently a paid subscription is required at the then current rate. Standard text rates and/or data usage may apply. See retailer and check www.Nissan.ca/NissanConnect for details. ³Parking aid/convenience feature. Cannot completely eliminate blind spots. May not detect every object and not warn of moving objects. Always check surroundings and turn to look behind you before moving vehicle. ⁴Availability of specific features is dependent upon the phone's Bluetooth® support. Please refer to your phone Owner's Manual for details. Bluetooth® word mark and logos are owned by Bluetooth SIG, Inc., and any use of such marks by Nissan is under licence. ⁵XM® and SiriusXM® Satellite Radio is available in the 10 Canadian provinces and the 48 contiguous United States. Basic monthly subscription required and sold separately after trial period. NavTraffic®/SiriusXM® Traffic is available in select North American markets. In Canada, at time of printing, incident and flow data is available for 12 metropolitan areas of Canada (Vancouver, Calgary, Edmonton, Toronto, Ottawa, Montreal, Quebec City, Hamilton, St. Catharines, Kitchener, Guelph, and London). Subscription sold separately after trial period. All subscriptions subject to customer agreement at siriusxm.ca/terms. Fees and programming subject to change. © 2014 Sirius XM Canada Inc. The Sirius® XM®, and SiriusXM® names and all related marks and logos are trademarks of Sirius XM Radio Inc. All other trademarks are the property of their respective owners. ⁶Factory-installed option. Never program while driving. GPS mapping may not be detailed in all areas or reflect current road status. ⁷Use the text messaging feature after stopping your vehicle in a safe location. If you have to use the feature while driving, exercise extreme caution at all times so full attention may be given to vehicle operation. Compatible smartphone required. Standard text rates and/or data usage may apply. ⁸Driving is serious business and requires your full attention. If you have to use the connected device while driving, exercise extreme caution at all times so full attention may be given to vehicle operation. iPod® is a registered trademark of Apple, Inc. All rights reserved. iPod® not included. The Apple App Store logo is a registered trademark of Apple, Inc. All rights reserved. Facebook® is a registered trademark of Facebook, Inc. Google® and Google Play logo are registered trademarks of Google Inc. TripAdvisor® is a registered trademark of TripAdvisor LLC, Ltd. Twitter® is a registered trademark of Twitter, Inc.



GO WIDE – KING CAB.®

The Wide Open rear doors on Titan® King Cab® make entering or loading the cabin a snap. Other trucks out there may have imitated the design, but Nissan was the first to perfect the Wide Open door. And with no B-pillar to get in the way, plus a fold-up rear bench seat, your cargo flexibility is as wide open as your doors.

- Two available seating configurations: 6-passenger with front bench seat or 5-passenger with front captain's chairs
- Standard rear fold-up bench seat and a flat loading floor for more usable area

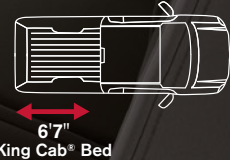

Nissan Titan® SV King Cab® 4x4 shown in Almond Cloth. U.S. model shown.

GO LONG – CREW CAB.

As in one of the longest Crew Cab beds in its class.¹ Plenty of room for whatever you need to bring along – work or play. While inside the massive cabin, you'll find an impressive amount of head room and leg room and an overall passenger volume that's sure to inspire jealousy.

- 5-passenger seating with front captain's chairs
- Huge interior with 3557 L (126 cu. ft.) of passenger room
- Two available bed lengths:

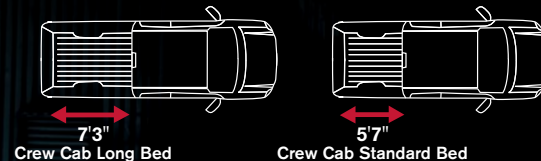

Nissan Titan® SV Crew Cab 4x4 shown in Brilliant Silver. U.S. model shown.

CHOOSE YOUR TRIM LEVEL

S CREW CAB

Features 317 HP 5.6-litre DOHC V8, 5-speed automatic transmission, 4x4 drivetrain, 4-wheel disc brakes with ABS, 18" aluminum-alloy wheels, body-colour front bumper and black grille, power windows and door locks, remote keyless entry with remote windows down, cruise control, AM/FM/CD audio system, air conditioning, tilt steering wheel, 6-passenger capacity, front bench seat with fold-down centre console armrest, power front and rear windows, power back window, rear privacy glass, rear reading lights, 60/40 split flip-up rear bench seat, spray-on bedliner, rear tailgate spoiler, carpeted flooring, six standard airbags, 4-wheel Active Brake Limited Slip (ABLS), and Vehicle Dynamic Control (VDC).



SV KING CAB® CREW CAB CREW CAB LONG BED

Includes S equipment plus:

Upgraded tires, chrome grille and bumpers, heavy-duty battery, tow hitch receiver, tow hooks, Utili-track® Channel System, lockable bedside storage, tailgate illumination, Rear Sonar System², two 120-volt AC power outlets, power heated outside tow mirrors, centre console with gated shifter, 8-way power driver's seat, leather-wrapped steering wheel, AM/FM/CD audio system with 127 mm (5.0") colour display, NissanConnectSM with Mobile Apps, RearView Monitor, Streaming audio via Bluetooth® wireless technology, hands-free text messaging assistant, USB connection port, Bluetooth® Hands-Free Phone System, SiriusXM® Satellite Radio³



PRO-4X® KING CAB® CREW CAB

Includes SV equipment plus:

Locking rear differential, 18" dark-finished aluminum-alloy off-road wheels with P275/70R18 tires, Rancho® off-road performance shocks, skid plates (transfer case and lower radiator), body-colour bumpers, satin chrome-finished grille, automatic on/off headlights, fog lights, Nissan Navigation System with 147 mm (5.8") colour touch-screen monitor, SiriusXM® Traffic,³ Rockford Fosgate® audio system, and unique interior trim and gauges.

AVAILABLE PACKAGE:

- PRO-4X® Option Package (Crew Cab only)



SL CREW CAB

Includes SV equipment plus:

20" Chrome-clad alloy wheels, automatic on/off headlights, fog lights, chrome tubular step rails, power sliding glass moonroof, Nissan Navigation System with 147 mm (5.8") colour touch-screen monitor, SiriusXM® Traffic,³ Rockford Fosgate® audio system, Dual Zone Automatic Temperature Control (ATC), 4-way power front-passenger's seat, leather-appointed seats, heated front seats, Memory System (driver's seat, outside mirrors and pedals), and wood-tone trim.



¹Global Automakers of Canada (GAC). Half-ton Large Pickup Segmentation. ²The Sonar System is a convenience, not a substitute for proper parking and/or backing procedures. Always check that it is safe to do so before moving vehicle. May not detect every object. ³XM® and SiriusXM® Satellite Radio is available in the 10 Canadian provinces and the 48 contiguous United States. Basic monthly subscription required and sold separately after trial period. NavTraffic®/SiriusXM® Traffic is available in select North American markets. In Canada, at time of printing, incident and flow data is available for 12 metropolitan areas of Canada (Vancouver, Calgary, Edmonton, Toronto, Ottawa, Montreal, Quebec City, Hamilton, St. Catharines, Kitchener, Guelph, and London). Subscription sold separately after trial period. All subscriptions subject to customer agreement at siriusxm.ca/terms. Fees and programming subject to change. © 2014 Sirius XM Canada Inc. The Sirius® XM® and SiriusXM® names and all related marks and logos are trademarks of Sirius XM Radio Inc. All other trademarks are the property of their respective owners. The Bluetooth® word mark and logos are owned by Bluetooth SIG, Inc., and any use of such marks by Nissan is under licence. iPod® is a registered trademark of Apple, Inc. All rights reserved. iPod® not included. ⁴Rancho is a registered trademark of Tenneco Automotive Operating Company, Inc. Rockford Fosgate® is a registered trademark of Rockford Corporation.

PAINT AND FABRIC

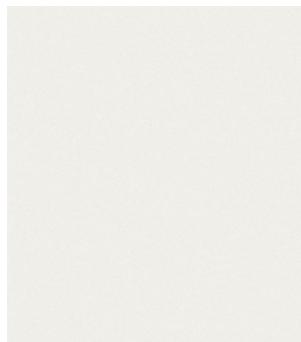

Glacier White QAK

	S	SV	PRO-4X*	SL
ALMOND CLOTH				
ALMOND LEATHER				
CHARCOAL CLOTH				
CHARCOAL LEATHER				



Pearl White¹ QAB

	S	SV	PRO-4X*	SL
ALMOND CLOTH				
ALMOND LEATHER				
CHARCOAL CLOTH				
CHARCOAL LEATHER				



Brilliant Silver¹ K23

	S	SV	PRO-4X*	SL
ALMOND CLOTH				
ALMOND LEATHER				
CHARCOAL CLOTH				
CHARCOAL LEATHER				



Cayenne Red¹ NAH

	S	SV	PRO-4X*	SL
ALMOND CLOTH				
ALMOND LEATHER				
CHARCOAL CLOTH				
CHARCOAL LEATHER				



Arctic Blue¹ RBG

	S	SV	PRO-4X*	SL
ALMOND CLOTH				
ALMOND LEATHER				
CHARCOAL CLOTH				
CHARCOAL LEATHER				

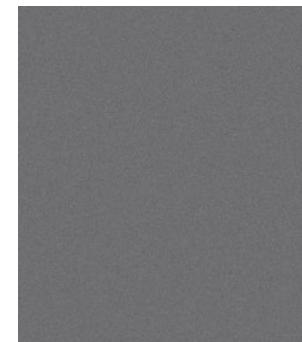

Gun Metallic¹ KAD

	S	SV	PRO-4X*	SL
ALMOND CLOTH				
ALMOND LEATHER				
CHARCOAL CLOTH				
CHARCOAL LEATHER				



Magnetic Black¹ G41

	S	SV	PRO-4X*	SL
ALMOND CLOTH				
ALMOND LEATHER				
CHARCOAL CLOTH				
CHARCOAL LEATHER				

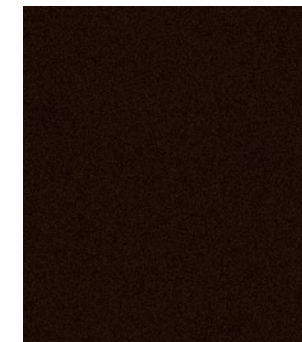

Espresso Black¹ CAE

	S	SV	PRO-4X*	SL
ALMOND CLOTH				
ALMOND LEATHER				
CHARCOAL CLOTH				
CHARCOAL LEATHER				

■ Standard

▣ Part of PRO-4X* Option Package

¹Extra cost option

Nissan has taken care to ensure that the colour swatches presented here are the closest possible representations of actual vehicle colours. Swatches may vary slightly due to the printing process and whether viewed in daylight, fluorescent or incandescent light. Please see the actual colours at your local Nissan dealer.



S CHARCOAL CLOTH



SV ALMOND CLOTH



SV CHARCOAL CLOTH



PRO-4X* CHARCOAL CLOTH



PRO-4X* CHARCOAL LEATHER



SL ALMOND LEATHER

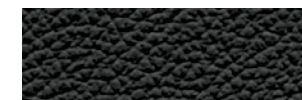

SL CHARCOAL LEATHER

GENUINE NISSAN ACCESSORIES

Every Genuine Nissan Accessory is: custom-fit, custom-designed and durability-tested; backed by Nissan's 3 year/60,000 km Accessories limited warranty; and can be financed when installed by dealer at time of purchase.²

A. Sliding Bed Extender³

Perfect for the long haul.

B. Sliding Tool Box

Slide it forward when you're on the move. Slide it back for easy access on the job.

C. Side-window Deflectors

Enjoy fresh air with less wind noise.

D. Hood Deflector

Bugs and road grime won't bug you.

Additional Accessories:

- All-season Floor Mats
- Torza Top Tonneau Cover
- Moonroof Wind Deflector
- Step Rails
- Retractable Rear Bumper Step
- Chrome Taillight Guard
- Telescoping Mirrors⁴
- Bed Rails
- Chrome Wheels
- Bed Tent
- And More

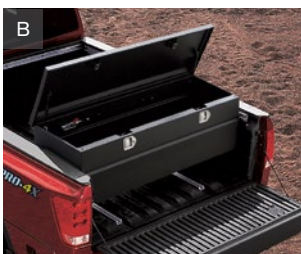

See your Nissan dealer for details, or go to accessories.nissan.ca

BUYING AND OWNING

Finance Options Through Nissan Canada Finance, we offer many attractive lease and purchase options that can be tailored to your individual needs. We have unique programs such as the Nissan Grad Program or the New Canadian Program designed just for you. Please visit our website Nissan.ca/finance to explore all of the options available. We have also made it easy to pre-qualify online. All of our programs come with competitive rates and terms. With our flexible options, driving home a new Nissan has never been easier. Consult your local Nissan Dealership for complete details.

No-Nonsense Warranty Every 2015 Nissan is covered by a 3 year/60,000 km⁵ Comprehensive New Vehicle Warranty, a 5 year/100,000 km⁵ Powertrain Warranty, an 8 year/130,000 km⁵ Emission Control Warranty on selected components, and a 5 year/unlimited km Corrosion Perforation Warranty. As a Nissan owner, you'll also receive a 3 year Roadside Assistance program available to you 24 hours a day. Terms, conditions and exclusions apply. See Warranty Information Booklet for complete details.

Added Security Plan (ASP) For ultimate peace of mind, consider the Nissan Added Security Plan. It's our commitment to be there for you, and to help you leave your worries behind. Different plans, available for both purchased and leased vehicles, let you tailor the coverage to your driving habits.

Security+Plus™ Prepaid Maintenance Plan The smart choice when it comes to maintaining your new Nissan. Honoured at all participating Nissan Dealers in Canada and the U.S., your vehicle is cared for by factory-trained technicians using Genuine Nissan Parts. And best of all, there's no worrying about price increases on parts or service in the future. A variety of plans are available. Ask your Dealer for details.



Nissan's environmental action plan focuses on several key areas. Increasing production of Zero Emission vehicles, including the 100% electric LEAF.[®] Improving fuel efficiency through our PUREDRIVE™ measures. And reducing the environmental impact of manufacturing through energy-efficient practices in our plants around the world.



²See your Nissan Dealership and read the actual limited warranty. ³Cargo and load capacity limited by weight and distribution. Always secure all cargo. ⁴See Nissan Towing Guide and Owner's Manual for proper use. ⁵Whichever occurs first.

SPECIFICATIONS

Engine	KING CAB*		CREW CAB			
	SV	PRO-4X®	S	SV	PRO-4X®	SL
VK56DE – 5.6-litre DOHC 32-valve V8 engine						
Horsepower – 317 HP @ 5200 rpm						
Torque – 385 lb-ft @ 3400 rpm						
Heavy-duty battery (710 CCA)						
Engine block heater						

Drivetrain	KING CAB*		CREW CAB			
	SV	PRO-4X®	S	SV	PRO-4X®	SL
5-speed automatic transmission with Tow/Haul Mode						
Lower final gear ratio (3.357:1)						
4WD system with shift-on-the-fly 2-speed transfer case						
(4H – 1.000; 4LO – 2.596)						
Switch-on-demand electronic locking rear differential						

Brakes	KING CAB*		CREW CAB			
	SV	PRO-4X®	S	SV	PRO-4X®	SL
Front and rear vented disc brakes						
4-wheel Anti-lock Braking System (ABS)						
Electronic Brake force Distribution (EBD) and Brake Assist						

Suspension/Steering	KING CAB*		CREW CAB			
	SV	PRO-4X®	S	SV	PRO-4X®	SL
Independent double-wishbone front suspension with stabilizer bar						
Multi-leaf rear suspension with solid Dana® axle						
Rancho® high-performance shocks						
Engine-speed-sensitive power-assisted rack-and-pinion steering						

Wheels/Tires	KING CAB*		CREW CAB			
	SV	PRO-4X®	S	SV	PRO-4X®	SL
18" x 8.0" 5-spoke aluminum-alloy wheels						
18" x 8.0" 6-spoke aluminum-alloy wheels						
18" x 8.0" 6-spoke dark finished aluminum-alloy wheels						
20" x 8.0" 5-spoke chrome-clad alloy wheels						
P265/70R18 tires						
P265/70R18 tires with raised outlined white lettering						
P275/70R18 tires with raised outlined white lettering						
P275/60R20 tires						

Exterior Features	KING CAB*		CREW CAB			
	SV	PRO-4X®	S	SV	PRO-4X®	SL
Standard Bed						
Long Bed						
Fuel tank skid plate, oil pan skid plate						
Transfer case skid plate and lower radiator skid plate						
Automatic on/off headlights						
Chrome tubular step rails						
Fog lights						
Front tow hooks						
Tow hitch receiver						
Body-colour front bumper and painted silver rear bumper with black grille						
Chrome grille and bumpers						
Body-colour front and rear bumpers with satin chrome grille						
Black manual outside mirrors and door handles						
Black power heated outside tow mirrors and door handles						
Chrome power heated outside tow mirrors and door handles						
Body-colour side mouldings						
Rear Sonar System						
Rear privacy glass						
Bed rope hooks, stake holder and separator/shelf provision						
Utii-track® Channel System with four tie-down cleats						
Factory-applied spray-on bedliner						
Lockable driver-side bedside storage						
Tailgate illumination and bed-mounted 120-volt AC power outlet						
Locking tailgate with rear spoiler and cargo bed light						

Exterior Features (Continued)	KING CAB*		CREW CAB			
	SV	PRO-4X®	S	SV	PRO-4X®	SL
Sliding rear window (power rear window on CC)						
Power sliding glass moonroof (one-touch open/close)						

Comfort/Convenience	KING CAB*		CREW CAB			
	SV	PRO-4X®	S	SV	PRO-4X®	SL
Nissan Navigation System with 147 mm (5.8") colour touch-screen monitor						
Nissan Voice Recognition for audio and navigation						
SiriusXM® Traffic ¹						
NissanConnect SM with Mobile Apps ²						
Hands-free text messaging assistant						
RearView Monitor						
Bluetooth® Hands-Free Phone System						
Air conditioning						
In-cabin microfilter						
Dual Zone Automatic Temperature Control (ATC)						
Power windows and door locks						
Remote keyless entry with remote windows down						
HomeLink® universal garage-door opener						
Cruise control with steering wheel-mounted controls						
Variable intermittent wipers						
Tilt steering column						
Front door courtesy lights						
Auto-dimming rearview mirror						
Digital compass and outside temperature display						
Centre console-mounted 120-volt AC power outlet						
Digital clock, retained accessory power, and battery saver						
Transmission temperature gauge						
Sun visors with illuminated vanity mirrors and extension						
Power adjustable pedals						

Seating Appointments	KING CAB*		CREW CAB			
	SV	PRO-4X®	S	SV	PRO-4X®	SL
40/20/40 split front bench seat with fold-down centre console						
Front captain's chairs with driver-side power lumbar						
8-way power driver's seat						
4-way power front-passenger's seat						
Heated front seats						
60/40 Split flip-up/fold-down rear bench seat						
Memory System – driver's seat, outside mirrors, and pedals						
Cloth seat trim						
Two-tone cloth seat trim with white stitching						
Leather-appointed seats						
Column shifter with manual shift mode						
Leather-wrapped transmission shifter and steering wheel						
Driver seatback pocket (captain's chairs only)						
Up to eight cup holders on CC (six on KC)						
Overhead centre console						
Overhead rear centre console						
Wood-tone trim						
White-faced gauges						
Rear reading lights						
Carpeted flooring						

Audio/Entertainment	KING CAB*		CREW CAB			
	SV	PRO-4X®	S	SV	PRO-4X®	SL
AM/FM/CD audio system						
AM/FM/CD audio system with 127 mm (5.0") colour display						
Rockford Fosgate®-powered AM/FM/CD audio system						
MP3/WMA playback capability						
Radio Data System (RDS)						
SiriusXM® Satellite Radio ¹						

Audio/Entertainment (Continued)	KING CAB*		CREW CAB			
	SV	PRO-4X®	S	SV	PRO-4X®	SL
Streaming audio via Bluetooth® wireless technology						
USB connection port for iPod® interface and other compatible devices						
Steering wheel-mounted audio controls						
Eight speakers on CC; six speakers on KC						
Ten speakers on CC; eight speakers on KC						

Safety/Security	KING CAB*		CREW CAB			
	SV	PRO-4X®	S	SV	PRO-4X®	SL
Nissan Advanced Airbag System with dual-stage supplemental front airbags with seat belt sensors and occupant-classification sensor ³						
Driver and front-passenger side-impact supplemental airbags ³						
Roof-mounted curtain supplemental airbags for side-impact and rollover protection for front and rear outboard occupants ³						
Vehicle Dynamic Control (VDC) with Traction Control System (TCS)						
Active Brake Limited Slip (ABLS)						
Front-seat Active Head Restraints						
3-point ALR/ELR passenger seat belt system (ELR for driver)						
Front seat belts with pre-tensioners and load limiters						
LATCH System (Lower Anchors and Tethers for CHildren)						
Zone Body construction with front and rear crumple zones						
Hood-buckling creases and energy-absorbing steering column						
Pipe-style steel side-door guard beams						
Tire Pressure Monitoring System (TPMS)						
Anti-theft system and Immobilizer Key System						

Standard
 Optional
 P Part of PRO-4X® Option Package

The Nissan Safety Shield.® Over 50 standard safety features, including six standard airbags and front-seat Active Head Restraints. All with one goal in mind: to help you and your loved ones be safe.³

Six standard airbags. Start with dual-stage supplemental front airbags, including an occupant-classification sensor. If the front-passenger seat is empty, for example, the sensor deactivates that airbag. Built into the front seats are seat-mounted side-impact supplemental airbags. They even move with you when you adjust your preferred seating position. Up above are roof-mounted curtain supplemental airbags for both rows. They work to help provide enhanced head protection for outboard occupants.³

Ready with a rollover sensor. In the unlikely event of a rollover, Titan® has already thought ahead. Every Titan® has a sensor that detects an impending rollover, then deploys the curtain airbags to help protect you.³

*XM® and SiriusXM® Satellite Radio is available in the 10 Canadian provinces and the 48 contiguous United States. Basic monthly subscription required and sold separately after trial period. NavTraffic®/SiriusXM® Traffic is available in select North American markets. In Canada, at time of printing, incident and flow data is available for 12 metropolitan areas of Canada (Vancouver, Calgary, Edmonton, Toronto, Ottawa, Montreal, Quebec City, Hamilton, St. Catharines, Kitchener, Guelph, and London). Subscription sold separately after trial period. All subscriptions subject to customer agreement at siriusxm.ca/terms. All fees and programming subject to change. © 2014 Sirius XM Canada Inc. The Sirius®, XM®, and SiriusXM® names and all related marks and logos are trademarks of Sirius XM Radio Inc. All other trademarks are the property of their respective owners. ²Driving is serious business. Only use NissanConnectSM services when safe to do so. Subscription agreement required. Compatible smartphone required. Not all app features are available for all models. Some apps have late availability. May require dealer service visit or software upgrade to activate. Never program while driving. GPS mapping may not be detailed in all areas or reflect current road status. Cellular network not available in all areas. Cellular network, apps, and services, including Google® services, are provided by independent companies not within Nissan's control and may require subscription and owner consent to activate. Should provider terminate/restrict service, service may be terminated without notice or liability to Nissan and/or its agents. Nissan not responsible for any equipment or app replacement/upgrades, or associated costs, that may be required for continued operation. Terms and conditions of Subscription Agreement apply. 36-month trial period starts on vehicle sale date; subsequently a paid subscription is required at the then current rate. Standard text rates and/or data usage may apply. See retailer and check Nissan.ca/NissanConnect for details. ³Airbags are only a supplemental restraint system; always wear your seat belt. Even with the occupant-classification sensor, rear-facing child restraints should not be placed in the front-passenger's seat. Also, in addition to any other requirement of applicable law, all children 12 and under should ride in the rear seat properly secured in child restraints, booster seats, or seat belts according to their size. Airbags will only inflate in certain accidents; see your Owner's Manual for more details. Inflated airbags shown for illustration purposes only. Actual coverage area may differ. Airbags deflate after deployment. The Bluetooth® word mark and logos are owned by Bluetooth SIG, Inc., and any use of such marks by Nissan is under licence. Dana® is a registered trademark of Dana Corporation. Google® is a registered trademark of Google Inc. HomeLink® is a registered trademark of Johnson Controls Technology Company. iPod® is a registered trademark of Apple, Inc. All rights reserved. iPod® not included. ®Rancho is a registered trademark of Tenneco Automotive Operating Company, Inc.

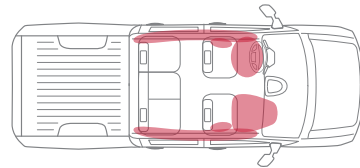

PACKAGES

P PRO-4X® Option Package (Crew Cab) <ul style="list-style-type: none"> Power sliding glass moonroof PRO-4X® embroidered leather-appointed seats Heated front seats Memory System – driver's seat, outside mirrors, and pedals 4-way power passenger's seat In-cabin microfilter

DIMENSIONS/CAPACITIES/WEIGHTS/FUEL

Dimensions – mm (inches)		
Exterior	King Cab®	Crew Cab
	Standard Bed	Standard Bed/Long Bed
Wheelbase	3550 (139.8)	3550 (139.8)/4050 (159.5)
Overall length	5704 (224.6)	5704 (224.6)/6204 (244.2)
Overall width	2019 (79.5)	2019 (79.5)
Overall height	1890–1945 (74.6–76.6)	1937–1953 (76.3–76.9)
Bed length	2010 (79.1)	1710 (67.3)/2210 (87.0)
Bed width	1620 (63.8)	1620 (63.8)
Bed opening width	1530 (60.2)	1530 (60.2)
Bed width between wheelhouse	1270 (50.0)	1270 (50.0)
Bed depth	506 (19.9)	506 (19.9)

Interior (front/rear)		
Head room	1040/988 (41.0/38.9)	1040/1026 (41.0/40.4)
With moonroof	NA	1008/1026 (39.7/40.4)
Leg room	1063/837 (41.8/33.0)	1063/1026 (41.8/40.4)
Hip room	1558/1531 (61.3/60.3)	1558/1536 (61.3/60.5)
Shoulder room	1654/1648 (65.1/64.9)	1654/1640 (65.1/64.6)

Capacities		
Seating capacity	King Cab®	Crew Cab
With front bench seat	-	6
With front captain's chairs	5	5
Interior passenger volume – L (cu. ft.)	3194 (112.8)	3557 (125.6)
Fuel tank – L (Imp gal)	106 (23.3)	106 (23.3) SWB/140 (30.8) LWB
	King Cab®	Crew Cab
	Standard Bed	Standard Bed/Long Bed
Payload – kg (lbs)		
S	NA	822 (1812)/NA
SV	816 (1799)	766 (1688)/671 (1479)
PRO-4X®	788 (1737)	726 (1600)/NA
SL	NA	681 (1501)/NA

Maximum towing capacity – kg (lbs)		
S	NA	3311 (7300)/NA
SV	4264 (9400)	4218 (9300)/4082 (9000)
PRO-4X®	4218 (9300)	4218 (9300)/NA
SL	NA	4128 (9100)/NA

Curb Weights – kg (lbs)		
	King Cab®	Crew Cab
	Standard Bed	Standard Bed/Long Bed
S	NA	2444 (5389)/NA
SV	2405 (5302)	2500 (5512)/2620 (5778)
PRO-4X®	2433 (5364)	2540 (5601)/NA
SL	NA	2585 (5699)/NA

2015 Fuel Consumption Estimates – L/100 km (MPG)

Fuel Economy estimates not available at time of printing. Please contact your Nissan Dealership or visit nissan.ca for more information.

SWB: Short Wheelbase LWB: Long Wheelbase