



# OWNER'S MANUAL

Operation  
Maintenance  
Specifications

All information in this Owner's Manual is current at the time of publication. However, HYUNDAI reserves the right to make changes at any time so that our policy of continual product improvement may be carried out.

This manual applies to all models of this vehicle and includes descriptions and explanations of optional as well as standard equipment.

As a result, you may find material in this manual that does not apply to your specific vehicle.

### **CAUTION: MODIFICATIONS TO YOUR HYUNDAI**

Your HYUNDAI should not be modified in any way. Such modifications may adversely affect the performance, safety or durability of your HYUNDAI and may, in addition, violate conditions of the limited warranties covering the vehicle. Certain modifications may also be in violation of regulations established by the U.S. Department of Transportation and other federal or state agencies.

### **TWO-WAY RADIO OR CELLULAR TELEPHONE INSTALLATION**

Your vehicle is equipped with electronic fuel injection and other electronic components. It is possible for an improperly installed/adjusted two-way radio or cellular telephone to adversely affect electronic systems. For this reason, we recommend that you carefully follow the radio or cell phone manufacturer's instructions or consult your authorized HYUNDAI dealer for precautionary measures or special instructions if you choose to install one of these devices.

---

## SAFETY AND VEHICLE DAMAGE WARNING

This manual includes information titled as DANGER, WARNING, CAUTION and NOTICE.

These titles indicate the following:



### **DANGER**

**DANGER** indicates a hazardous situation which, if not avoided, will result in death or serious injury.



### **WARNING**

**WARNING** indicates a hazardous situation which, if not avoided, could result in death or serious injury.



### **CAUTION**

**CAUTION** indicates a hazardous situation which, if not avoided, could result in minor or moderate injury.

### **NOTICE**

**NOTICE** indicates a situation which, if not avoided, could result in vehicle damage.

## HYUNDAI VEHICLE OWNER PRIVACY POLICY

Your Hyundai vehicle may be equipped with technologies and services that use information collected, generated, recorded or stored by the vehicle. Hyundai has created a Vehicle Owner Privacy Policy to explain how these technologies and services collect use and share this information.

You may read our Vehicle Owner Privacy Policy on the Hyundaiusa.com website at: <https://www.hyundaiusa.com/owner-privacy-policy.aspx>

If you would like to receive a hard copy of our Vehicle Owner Privacy Policy, please contact our Customer Care Center at:

Hyundai Customer Care  
P.O. Box 20850  
Fountain Valley, CA 92728 800-633-5151  
[consumeraffairs@hmausa.com](mailto:consumeraffairs@hmausa.com)

Hyundai's Customer Care Center representatives are available Monday through Friday,

between the hours of 6:00 AM and 5:00 PM PST and Saturday between 6:30 AM and 3:00 PM PST.

For Customer Care assistance in Spanish or Korean, representatives are available Monday through Friday between 6:30 AM and 3:00 PM PST.



## Table of contents

---

Foreword	1
Vehicle Information, Consumer Information and Reporting Safety Defects	2
Seats & Safety System	3
Instrument Cluster	4
Convenient Features	5
Driving your Vehicle	6
Driver Assistance System	7
Emergency Situations	8
Maintenance	9
Index	I

## FOREWORD

Congratulations, and thank you for choosing HYUNDAI. We are pleased to welcome you to the growing number of discerning people who drive a HYUNDAI vehicle. We are very proud of the advanced engineering and quality of each HYUNDAI we build.

Your Owner's Manual will introduce you to the features and operation of your new HYUNDAI. To become familiar with your new HYUNDAI, so that you can fully enjoy it, read this Owner's Manual carefully before driving your new vehicle.

This manual contains important safety information and instructions intended to familiarize you with your vehicle's controls and safety features so you can safely operate your vehicle.

This manual also contains information on maintenance designed to enhance safe operation of the vehicle. It is recommended that all service and maintenance on your car be performed by an authorized HYUNDAI dealer. An authorized HYUNDAI dealer is prepared to provide high-quality service, maintenance and any other assistance that may be required.

This Owner's Manual should be considered a permanent part of your vehicle, and should be kept in the vehicle so you can refer to it at any time. The manual should stay with the vehicle if you sell it to provide the next owner with important operating, safety and maintenance information.

## HYUNDAI MOTOR AMERICA



### CAUTION

**Severe engine and transmission damage may result from the use of poor quality fuels and lubricants that do not meet HYUNDAI specifications. You must always use high quality fuels and lubricants that meet the specifications listed on Page 2-14 in the Vehicle Specifications section of the Owner's Manual.**

Copyright 2021 HYUNDAI Motor America. All rights reserved. No part of this publication may be reproduced, stored in any retrieval system or transmitted in any form or by any means without the prior written permission of HYUNDAI Motor America.

## GUIDE TO HYUNDAI GENUINE PARTS

### 1. What are HYUNDAI Genuine Parts?

HYUNDAI Genuine Parts are the same parts used by HYUNDAI Motor Company to manufacture vehicles. They are designed and tested for the optimum safety, performance, and reliability for our customers.

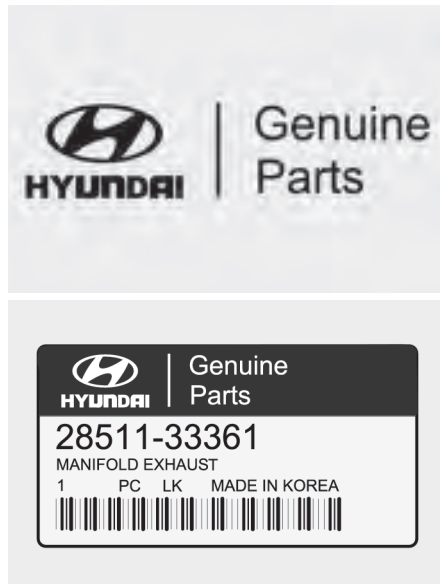

### 2. Why Hyundai Genuine Parts?

HYUNDAI Genuine Parts are engineered and built to meet rigid manufacturing requirements. Damage caused by using imitation, counterfeit or used salvage parts is not covered under the HYUNDAI New Vehicle Limited Warranty or any other HYUNDAI warranty.

In addition, any damage to or failure of HYUNDAI Genuine Parts caused by the installation or failure of an imitation, counterfeit or used salvage part is not covered by any HYUNDAI Warranty.



### 3. How can you tell if you are purchasing HYUNDAI Genuine Parts?

Look for the HYUNDAI Genuine Parts Logo on the package (see below).

HYUNDAI Genuine Parts exported to the U.S. are packaged with labels written in English.

HYUNDAI Genuine Parts are only sold through authorized HYUNDAI Dealerships.

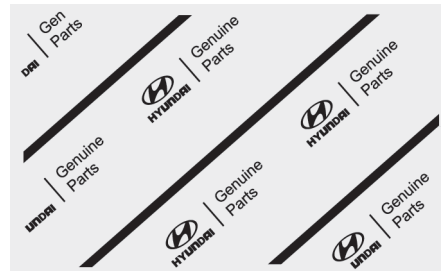

## HOW TO USE THIS MANUAL

We want to help you get the greatest possible driving pleasure from your vehicle. Your Owner's Manual can assist you in many ways. To gain an overview of the contents of your Owner's Manual, use the Table of Contents in the front of the manual. The first page of each Chapter includes a detailed Table of Contents of the topics in that Chapter.

To quickly locate information about your vehicle, use the Index in the back of the manual. It is an alphabetical list of what is in this manual and the page number where it can be found.

For your convenience, we have incorporated tabs on the right-hand page edges. These tabs are coded with the Chapter titles to assist you with navigating through the manual.

## SAFETY MESSAGES

Your safety, and the safety of others, is very important. This Owner's Manual provides you with many safety precautions and operating procedures. This information alerts you to potential hazards that may hurt you or others, as well as damage your vehicle.

Safety messages found on vehicle labels and in this manual describe these hazards and what to do to avoid or reduce the risks.

Warnings and instructions contained in this manual are for your safety. Failure to follow safety warnings and instructions can lead to serious injury or death.

Throughout this manual DANGER, WARNING, CAUTION, NOTICE and the SAFETY ALERT SYMBOL will be used.



This is the safety alert symbol. It is used to alert you to potential physical injury hazards. Obey all safety messages that follow this symbol to avoid possible injury or death. The safety alert symbol precedes the signal words DANGER, WARNING and CAUTION.



### **DANGER**

**DANGER** indicates a hazardous situation which, if not avoided, will result in death or serious injury.



### **CAUTION**

**CAUTION** indicates a hazardous situation which, if not avoided, could result in minor or moderate injury.



### **WARNING**

**WARNING** indicates a hazardous situation which, if not avoided, could result in death or serious injury.

### **NOTICE**

**NOTICE** indicates a situation which, if not avoided, could result in vehicle damage.

## FUEL REQUIREMENTS

### Gasoline engine

#### **Unleaded Fuel Only**

Your new vehicle is designed to perform optimally using unleaded fuel having an octane number  $((R+M)/2)$  of 87 (Research Octane Number 91) or higher. (Do not use methanol blended fuels)

Your new vehicle is designed to obtain maximum performance with UNLEADED FUEL, as well as minimize exhaust emissions and spark plug fouling.

#### **NOTICE**

To prevent damage to the engine and engine components, never add any fuel system cleaning agents to the fuel tank other than what has been specified. Consult an authorized HYUNDAI dealer for additional information.



#### **WARNING**

- Do not “top off” after the nozzle automatically shuts off when refueling.
- Always check that the fuel cap is installed securely to prevent fuel spillage in the event of an accident.

#### **Gasoline containing alcohol and methanol**

Gasohol, a mixture of gasoline and ethanol (also known as grain alcohol) are being marketed along with or instead of leaded or unleaded gasoline. For example, “E15” is a gasohol comprised of 15% ethanol and 85% gasoline.

Do not use gasohol containing more than 15% ethanol, and do not use gasoline or gasohol containing any methanol. Either of these fuels may cause drivability problems and damage to the fuel system, engine control system and emission control system.

Discontinue using gasohol of any kind if drivability problems occur.

“E85” fuel is an alternative fuel comprised of 85 percent ethanol and 15 percent gasoline, and is manufactured exclusively for use in Flexible Fuel Vehicles. “E85” is not compatible with your vehicle. Use of “E85” may result in poor engine performance and damage to your vehicle’s engine and fuel system. HYUNDAI recommends that customers do not use fuel with an ethanol content exceeding 15 percent.

#### **NOTICE**

To prevent damage to your vehicle’s engine and fuel system:

- Never use gasohol which contains methanol.
- Never use gasohol containing more than 15% ethanol.
- Never use leaded fuel or leaded gasohol.
- Never use “E85” fuel.

Your New Vehicle Limited Warranty does not cover damage to the fuel system or any performance problems caused by the use of “E85” fuel.

### ***Using Fuel Additives (except Detergent Fuel Additives)***

Using fuel additives such as:

- Silicone fuel additive
- Ferrocene (iron-based) fuel additive
- Other metallic-based fuel additives

May result in cylinder misfire, poor acceleration, engine stalling, damage to the catalyst, or abnormal corrosion, and may cause damage to the engine resulting in a reduction in the overall life of the powertrain.

- The Malfunction Indicator Lamp (MIL) may illuminate.

### **NOTICE**

**Damage to the fuel system or performance problem caused by the use of these fuels may not be covered by your New Vehicle Limited Warranty.**

### ***Gasoline containing MMT***

Some gasoline contains harmful manganese-based fuel additives such as MMT (Methylcyclopentadienyl Manganese Tricarbonyl).

HYUNDAI does not recommend the use of gasoline containing MMT.

This type of fuel can reduce vehicle performance and affect your emission control system.

The malfunction indicator lamp on the cluster may come on.

### ***Detergent Fuel Additives***

HYUNDAI recommends that you use good quality gasolines treated with detergent additives such as TOP TIER Detergent Gasoline, which help prevent deposit formation in the engine. These gasolines will help the engine run cleaner and enhance performance of the Emission Control System. For more information on TOP TIER Detergent Gasoline, please go to the website ([www.toptiergas.com](http://www.toptiergas.com)).

For customers who do not use TOP Tier Detergent Gasoline regularly, and have problems starting or the engine does not run smoothly, detergent-based fuel additives that you can purchase separately may be added to the gasoline. If TOP TIER Detergent Gasoline is not available, one bottle of additive added to the fuel tank according to the maintenance schedule is recommended (refer to the Maintenance Schedule in chapter 9).

Additives are available from your authorized HYUNDAI dealer along with information on how to use them. Do not mix other additives.

### ***Operation in foreign countries***

If you are going to drive your vehicle in another country, be sure to:

- Observe all regulations regarding registration and insurance.
- Determine that acceptable fuel is available.

## VEHICLE MODIFICATIONS

- This vehicle should not be modified. Modification of your vehicle could affect its performance, safety or durability and may even violate governmental safety and emissions regulations.

In addition, damage or performance problems resulting from any modification may not be covered under warranty.

- If you use unauthorized electronic devices, it may cause the vehicle to operate abnormally, wire damage, battery discharge and fire. For your safety, do not use unauthorized electronic devices.

### NOTICE

**Some warning sounds (including welcome/good-bye sound, etc.) are generated from the interior speakers or amplifiers. If necessary, we recommend you to purchase HYUNDAI Part to replace an interior speaker or amplifier. Any unauthorized product may cause a malfunction of the interior speakers or amplifiers.**

## VEHICLE BREAK-IN PROCESS

By following a few simple precautions for the first 600 miles (1,000km) you may add to the performance, economy and life of your vehicle.

- Do not race the engine.
- While driving, keep your engine speed (RPM, or revolutions per minute) between 2,000 RPM and 4,000 RPM.
- Do not maintain a single speed for long periods of time, either fast or slow. Varying engine speed is needed to properly break-in the engine.
- Avoid hard stops, except in emergencies, to allow the brakes to seat properly.
- Fuel economy and engine performance may vary depending on vehicle break-in process and be stabilized after 4,000 miles (6,000 km). New engines may consume more oil during the vehicle break-in period.
- Do not tow a trailer during the first 1,200 miles (2,000km) of operation.



### WARNING

#### CALIFORNIA PROPOSITION 65 WARNING

Items contained in motor vehicles or emitted from them are known to the State of California to cause cancer and birth defects or reproductive harm. These include:

- Gasoline and its vapors
- Engine exhaust
- Used engine oil
- Interior passenger compartment components and materials
- Component parts which are subject to heat and wear

In addition, battery posts, terminals and related accessories contain lead, lead compounds and other chemicals known to the State of California to cause cancer and reproductive harm.

For more information go to <https://www.p65warnings.ca.gov/passenger-vehicle>

## VEHICLE DATA COLLECTION AND EVENT DATA RECORDERS

This vehicle is equipped with an event data recorder (EDR). The main purpose of an EDR is to record, in certain crash or near crash-like situations, such as an air bag deployment or hitting a road obstacle, data that will assist in understanding how a vehicle's systems performed. The EDR is designed to record data related to vehicle dynamics and safety systems for a short period of time, typically 30 seconds or less.

The EDR in this vehicle is designed to record such data as:

- How various systems in your vehicle were operating;
- Whether or not the driver and passenger safety belts were buckled/fastened;
- How far (if at all) the driver was depressing the accelerator and/or brake pedal; and,
- How fast the vehicle was traveling.

These data can help provide a better understanding of the circumstances in which crashes and injuries occur. NOTE: EDR data are recorded by your vehicle only if a non-trivial crash situation occurs; no data are recorded by the EDR under normal driving conditions and no personal data (e.g., name, gender, age, and crash location) are recorded. However, other parties, such as law enforcement, could combine the EDR data with the type of personally identifying data routinely acquired during a crash investigation.

To read data recorded by an EDR, special equipment is required, and access to the vehicle or the EDR is needed. In addition to the vehicle manufacturer, other parties, such as law enforcement, that have the special equipment, can read the information if they have access to the vehicle or the EDR.



# 2. Vehicle Information, Consumer Information and Reporting Safety Defects

---

- Exterior Overview (I) .....2-2
- Exterior Overview (II).....2-3
- Interior Overview ..... 2-4
- Instrument Panel Overview (I) ..... 2-5
- Instrument Panel Overview (II) ..... 2-6
- Engine Compartment.....2-7
- Dimensions..... 2-8
- Engine..... 2-8
- Bulb Wattage..... 2-9
- Tires and Wheels.....2-10
- Air Conditioning System.....2-11
- Gross Vehicle Weight.....2-11
- Recommended Lubricants and Capacities..... 2-12
  - Recommended SAE Viscosity Number .....2-13
- Vehicle Identification Number (VIN) ..... 2-14
- Vehicle Certification Label ..... 2-14
- Tire Specification and Pressure Label ..... 2-14
- Engine Number ..... 2-15
- Refrigerant Label ..... 2-15
- Consumer Information ..... 2-16
- Reporting Safety Defects ..... 2-17

### EXTERIOR OVERVIEW (I)

■ Front view



1. Hood.....	5-64	5. Sunroof .....	5-59
2. Front lamps .....	9-58	6. Front windshield wiper blades .....	9-28
3. Tires and wheels.....	9-35	7. Windows .....	5-54
4. Side view mirror.....	5-52	8. Front radar .....	7-14

## EXTERIOR OVERVIEW (II)

■ Rear view

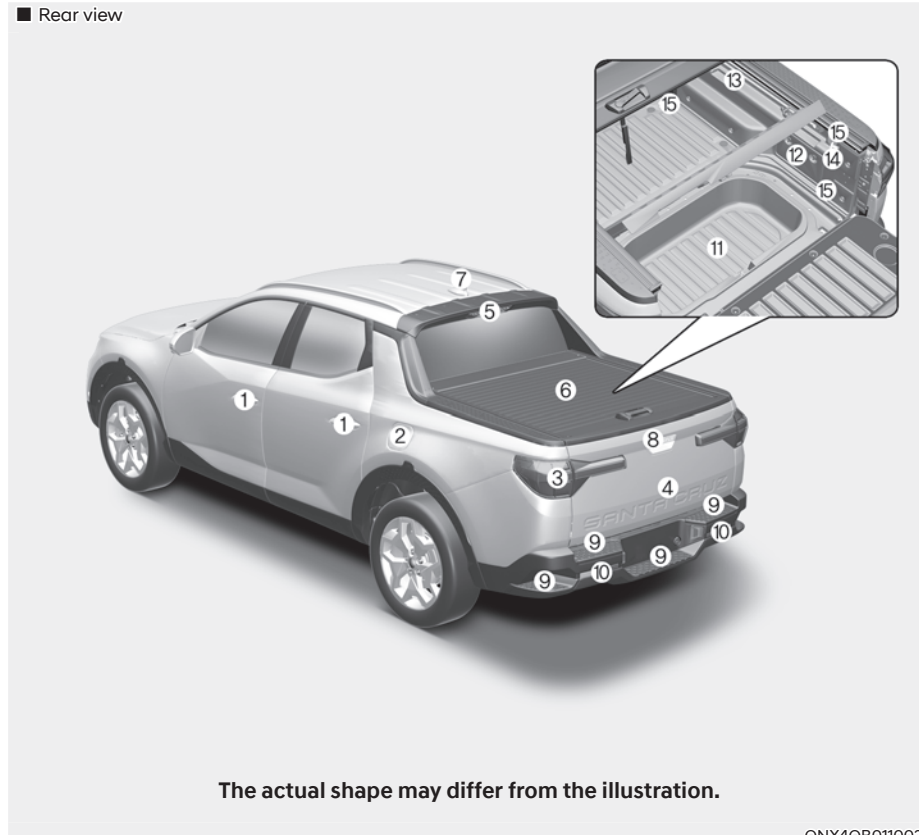

- |   |       |                                 |       |
|---|-------|---------------------------------|-------|
| 1. Door handle .....                                      | 5-32  | 8. Rear view camera .....       | 7-111 |
| 2. Fuel filler door .....                                 | 5-68  | 9. Rear bumper step .....       | 5-68  |
| 3. Rear combination lamp .....                            | 9-60  | 10. Reverse lamp .....          | 9-62  |
| 4. Tailgate .....   | 5-65  | 11. Underbed storage .....      | 5-119 |
| 5. High mounted stop lamp /<br>Top mounted bed lamp ..... | 9-62  | 12. Sidewall storage .....      | 5-121 |
| 6. Tonneau cover .....                                    | 5-114 | 13. Rail and cleat system ..... | 5-123 |
| 7. Antenna .....  | 5-132 | 14. Fixed tie downs .....       | 5-122 |
|   |       | 15. D-ring tie downs .....      | 5-122 |

## INTERIOR OVERVIEW

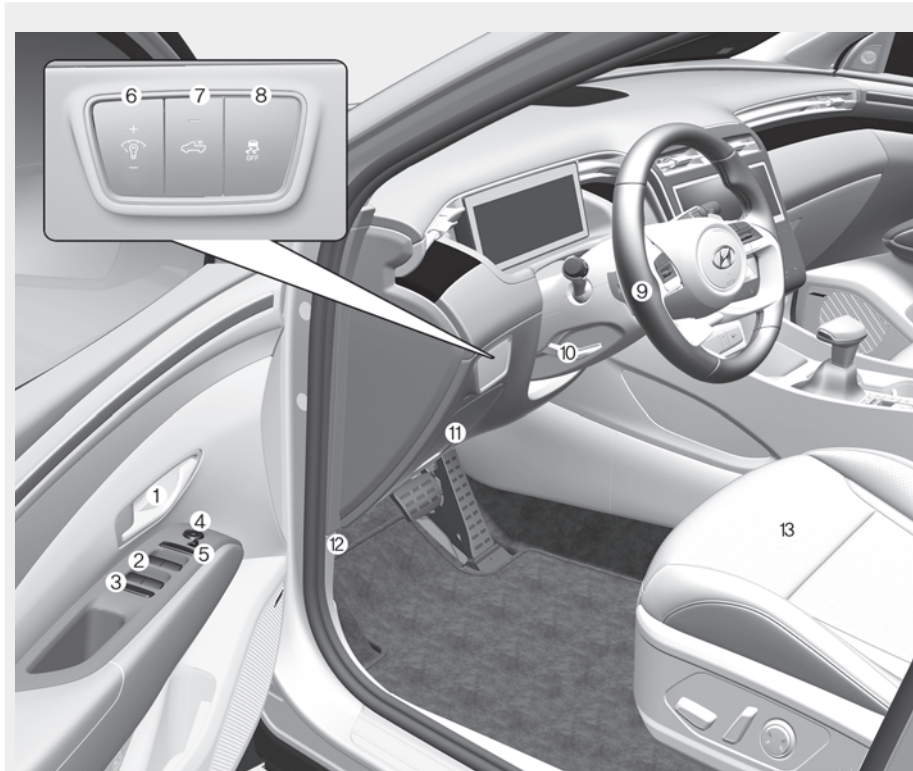

The actual shape may differ from the illustration.

ONX4OB011003

1. Inside door handle.....	5-34	7. Bed lamp ON/OFF Switch.....	5-81
2. Power window switches .....	5-54	8. ESC OFF Switch .....	6-39
3. Power window lock button.....	5-57	9. Steering wheel.....	5-39
4. Outside rearview mirror control switch .....	5-53	10. Steering wheel tilt/telescopic lever ....	5-40
5. Driver door lock switch .....	5-35	11. Fuse box.....	9-48
6. Instrument panel illumination control switch .....	4-5	12. Hood release lever.....	5-64
		13. Seat.....	3-3

## INSTRUMENT PANEL OVERVIEW (I)

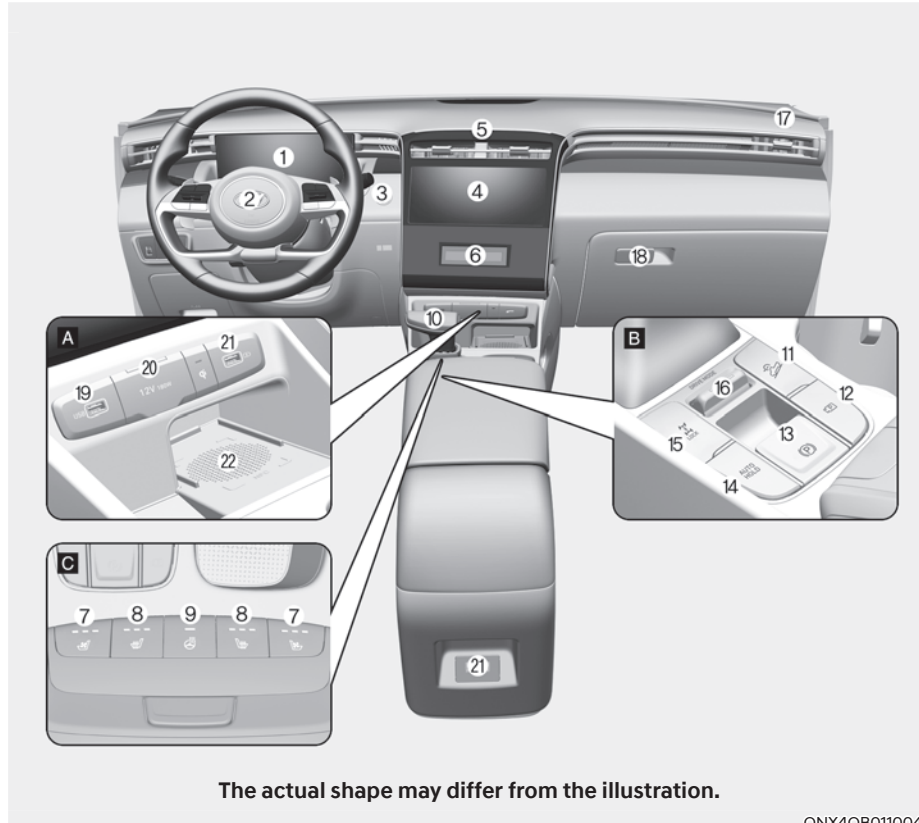

- |                                     |           |  |       |
|-------------------------------------|-----------|--|-------|
| 1. Instrument cluster .....         | 4-4       | 12. Parking/View button .....                      | 7-112 |
| 2. Driver's front air bag.....      | 3-42      | 13. EPB (Electronic Parking Brake)<br>switch ..... | 6-30  |
| 3. Key ignition switch/.....        | 6-5       | 14. Auto Hold switch .....                         | 6-34  |
| Engine Start/Stop button.....       | 6-8       | 15. AWD lock button .....                          | 6-51  |
| 4. Infotainment system .....        | 5-132     | 16. Drive mode switch .....                        | 6-48  |
| 5. Hazard warning lamp switch ..... | 8-2       | 17. Passenger's front air bag .....                | 3-42  |
| 6. Climate control system .....     | 5-85/5-93 | 18. Glove box .....                                | 5-113 |
| 7. Air ventilation seat.....        | 3-18      | 19. USB port.....                                  | 5-132 |
| 8. Seat warmer.....                 | 3-16      | 20. Power outlet.....                              | 5-125 |
| 9. Heated steering wheel .....      | 5-40      | 21. USB charger .....                              | 5-126 |
| 10. Transmission shift lever.....   | 6-14/6-21 | 22. Wireless charging system pad.....              | 5-127 |
| 11. DBC button .....                | 6-44      |  |       |

## INSTRUMENT PANEL OVERVIEW (II)

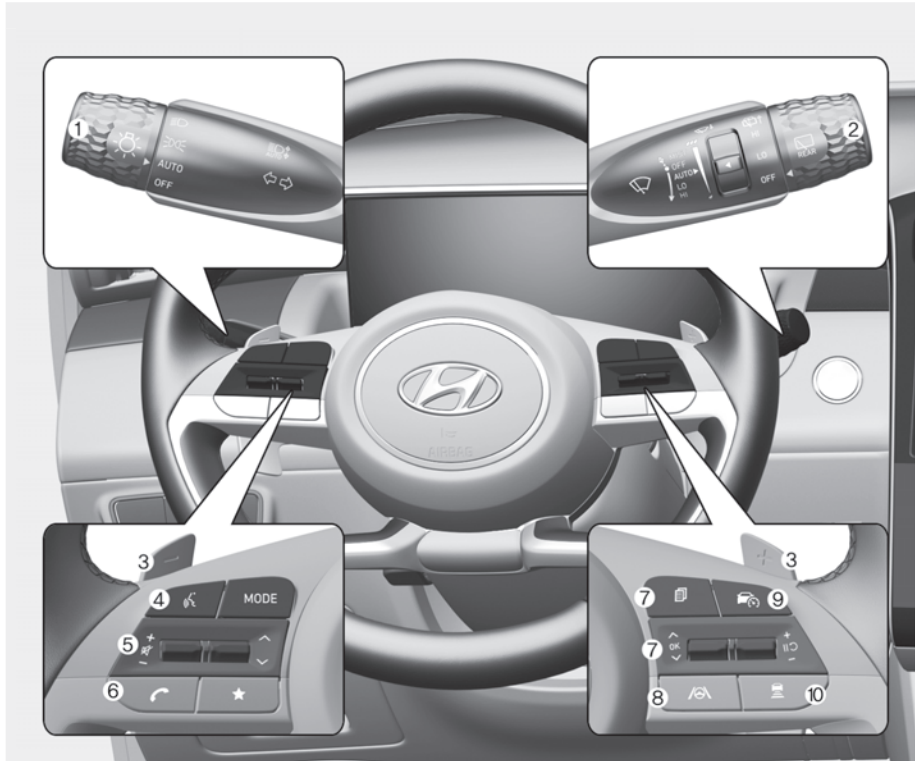

The actual shape may differ from the illustration.

ONX4OB011005

- |   |  |
|---|--|
| 1. Lighting control lever ..... 5-71        | 6. Bluetooth® hands-free phone button..5-134 |
| 2. Wiper and washer control lever..... 5-82 | 7. LCD display control .....4-27             |
| 3. Paddle shifter.....6-19                  | 8. Lane Driving Assist button..... 7-31      |
| 4. Voice recognition button .....5-134      | 9. Driving Assist button..... 7-56           |
| 5. Audio remote control buttons .....5-134  | 10. Vehicle Distance button..... 7-77        |

## ENGINE COMPARTMENT

### ■ Smartstream G2.5 GDI

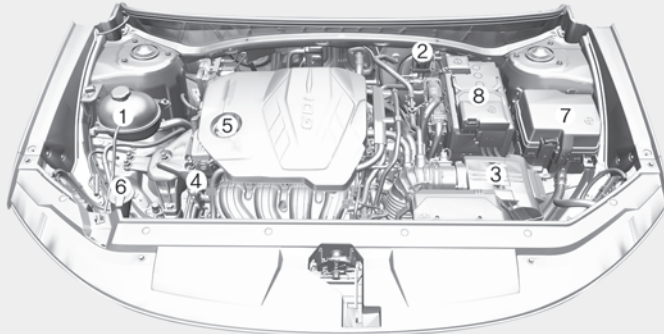

### ■ Smartstream G2.5 T-GDI

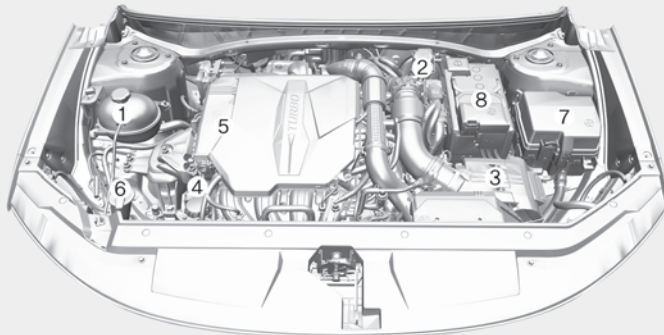

**The actual engine compartment in the vehicle may differ from the illustration.**

ONX4OB091016/ONX4OB091001

- |  |      |  |      |
|--|------|--|------|
| 1. Engine coolant reservoir .....  | 9-20 | 6. Windshield washer fluid reservoir ..... | 9-24 |
| 2. Brake fluid reservoir .....   | 9-23 | 7. Fuse box .....                          | 9-49 |
| 3. Air cleaner .....   | 9-25 | 8. Battery .....                           | 9-31 |
| 4. Engine oil dipstick .....   | 9-17 |  |      |
| 5. Engine oil filler cap (2.5 T-GDI's filler<br>cap is under the engine cover) ..... | 9-17 |  |      |

## DIMENSIONS

Items	in (mm)	
Overall length	195.67 (4,970)	
Overall width	75 (1,905)	
Overall height	66.73 (1,695)	
Tread	Front	Rear
	64.69 (1,643)	64.88 (1,648)
Wheelbase	118.30 (3,005)	

## ENGINE

Engine	Displacement cu. in (cc)	Bore x Stroke in. (mm)	Firing order	No. of cylinders
Smartstream G 2.5 GDI	152.4 (2,497)	3.5 x 4 (88.5 x 101.5)	1-3-4-2	4, in-line
Smartstream G 2.5 TGDI				



**BULB WATTAGE**

Light bulb			Bulb type	Wattage	
Front	Type A	Headlamp	High	HB3	60
			Low	HB3	60
		Daytime running lamp (DRL) / Position lamp		LED	LED
		Turn signal lamp		PY28W	28
		Side marker		LED	LED
	Type B	Headlamp	High	LED	LED
			Low	LED	LED
		Daytime running lamp (DRL) / Position lamp		LED	LED
		Turn signal lamp		LED	LED
		Side marker		LED	LED
Side repeater lamp (Outside mirror)			LED	LED	
Rear	Tail lamp (Inside)		LED	LED	
	Tail lamp (Outside) / Side Marker		LED	LED	
	Turn signal lamp/ Stop Lamp		P21W	21	
	Reverse lamp		W16W	16	
	License plate lamp		W5W	5	
	High mounted stop lamp		LED	LED	
	Top Mounted Bed Lamp		LED	LED	
	Side mounted Bed Lamp		LED	LED	
Interior	Map lamp	Bulb type	W10W	10	
		LED type	LED	LED	
	Room lamp	Bulb type	FESTOON	10	
		LED type	LED	LED	
	Glove box lamp		W5W	5	
	Sunvisor lamp		FESTOON	5	

## TIRES AND WHEELS

Items	Tire size	Wheel size	Inflation pressure psi (kPa)				Wheel nut torque lbf-ft (kgf-m, N-m)
			Normal load		Maximum load		
			Front	Rear	Front	Rear	
Full size tire	245/60 R18	7.5J X 18	35 (240)				79-94 (11-13)
	245/50 R20	7.5J X 20					
Compact spare tire	T135/80 D18	4.0T x 18	60 (420)				

### NOTICE

- It is permissible to add 3 psi to the standard tire pressure specification if colder temperatures are expected soon.  
Tires typically lose 1psi (7kPa) for every 12°F temperature drop. If extreme temperature variations are expected, recheck your tire pressure as necessary to keep them properly inflated.
- Tire inflation pressures will vary with changes in elevation. If driving in areas of higher or lower elevation, be sure to check and adjust for proper tire inflation.



### CAUTION

- When replacing tires, use the same size originally supplied with the vehicle. Using tires of a different size can damage the related parts or not work properly.
- When replacing tires, ALWAYS use the same size, type, construction and tread pattern supplied with the vehicle for all tires.

## AIR CONDITIONING SYSTEM

Items	Weight of volume	Classification
Refrigerant oz. (g)	21.16 (600) ± 0.88 (25)	R-1234yf
Compressor lubricant oz. (g)	3.5273 (100) ± 0.35 (10)	PAG

Contact an authorized HYUNDAI dealer for more details.

## GROSS VEHICLE WEIGHT

Items	Smartstream G2.5 GDi		Smartstream G2.5 TGD i	
	2WD	AWD	2WD	AWD
Gross vehicle weight lbs. (kg)	5,456 (2,475)	5,610 (2,545)	5,577 (2,530)	5,732 (2,600)

## RECOMMENDED LUBRICANTS AND CAPACITIES

To help achieve proper engine and powertrain performance and durability, use only lubricants of the proper quality. The correct lubricants also help promote engine efficiency that results in improved fuel economy.

These lubricants and fluids are recommended for use in your vehicle.

Lubricant		Volume	Classification
Engine oil *1 (drain and refill) Recommends 	Smartstream G2.5 GDI	6.13 US qt. (5.8 ℓ)	0W-20 SN PLUS/SP or ILSAC GF-6 *2
	Smartstream G2.5 T-GDI		0W-30 SN PLUS/SP or ILSAC GF-6 *2
Automatic transmission fluid		6.87 US qt. (6.5 ℓ)	MICHANG ATF SP-IV, SK ATF SP-IV, NOCA ATF SP-IV, HYUNDAI genuine ATF SP-IV or other brands meeting the above specification approved by HYUNDAI Motor Co.
Dual clutch transmission fluid	Smartstream G2.5 T-GDI	Gear oil	3.49 ~ 3.59 US qt. (3.3 ~ 3.4 ℓ) GS WDCTF HD G (WDGO-1)
		Control oil	2.59 ~ 2.64 US qt. (2.45 ~ 2.50 ℓ) GS WDCTF HD H (WDHO-1)
Coolant	Smartstream G2.5 GDI	10.00 US qt. (9.46 ℓ)	MIXTURE, Antifreeze with water (Ethylene glycol base coolant for aluminum radiator)
	Smartstream G2.5 T-GDI	9.12 US qt. (8.63 ℓ)	
Brake fluid		As required	SAE J1704 DOT-4 LV, FMVSS 116 DOT-4, ISO4925 CLASS-6
Rear differential oil (AWD)		0.56 ~ 0.67 US qt. (0.53 ~ 0.63 ℓ)	HYPOID GEAR OIL API GL-5, SAE 75W/85 (SK HCT-5 GEAR OIL 75W/85 or EQUIVALENT)
Transfer case oil (AWD)	Smartstream G2.5 GDI	0.66 ~ 0.72 US qt. (0.62 ~ 0.68 ℓ)	
	Smartstream G2.5 T-GDI	0.51 ~ 0.55 US qt. (0.48 ~ 0.52 ℓ)	
Fuel		17.69 US gal (67 ℓ)	Refer to "Fuel requirements" in chapter 1.

\*1: Refer to the recommended SAE viscosity numbers.

\*2: Requires <API Latest (or ILSAC Latest) Full synthetic> grade engine oil. If a lower grade engine oil (mineral oil including Semi-synthetic) is used, then the engine oil and engine oil filter must be replaced as indicated severe maintenance condition.

## Recommended SAE Viscosity Number



### CAUTION

Always be sure to clean the area around any filler plug, drain plug, or dipstick before checking or draining any lubricant. This is especially important in dusty or sandy areas and when the vehicle is used on unpaved roads. Cleaning the plug and dipstick areas will prevent dirt and grit from entering the engine and other mechanisms that could be damaged.

Engine oil viscosity (thickness) has an effect on fuel economy and cold weather operating (engine start and engine oil flowability). Lower viscosity engine oils can provide better fuel economy and cold weather performance, however, higher viscosity engine oils are required for satisfactory lubrication in hot weather. Using oils of any viscosity other than those recommended could result in engine damage.

When choosing an oil, consider the range of temperature your vehicle will be operated in before the next oil change. Proceed to select the recommended oil viscosity from the chart.

		Temperature Range for SAE Viscosity Numbers									
Temperature		°C	-30	-20	-10	0	10	20	30	40	50
		(°F)	-10	0	20	40	60	80	100	120	
Engine Oil *1	Smartstream G2.5 GDI	0W-20									
	Smartstream G2.5 T-GDI	0W-30									

\*1: Requires <API SN PLUS (or above) Full synthetic> grade engine oil. If a lower grade engine oil (mineral oil including Semi-synthetic) is used, then the engine oil and engine oil filter must be replaced as indicated for severe maintenance condition.



An engine oil displaying this API Certification Mark conforms to the international Lubricant Specification Advisory Committee (ILSAC). It is recommended to only use engine oils that uphold this API Certification Mark.

## VEHICLE IDENTIFICATION NUMBER (VIN)



The VIN is also on a plate attached to the top of the left side dashboard. The number on the plate can easily be seen through the windshield from outside.

## VEHICLE CERTIFICATION LABEL



The vehicle certification label attached on the driver's (or front passenger's) side center pillar gives the vehicle identification number (VIN).

## TIRE SPECIFICATION AND PRESSURE LABEL



The tires supplied on your new vehicle are chosen to provide the best performance for normal driving.

The tire label located on the driver's side center pillar gives the tire pressures recommended for your vehicle.

## ENGINE NUMBER

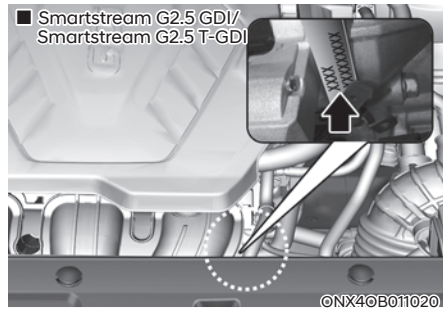

The engine number is stamped on the engine block as shown in the drawing.

## REFRIGERANT LABEL



The refrigerant label provides information such as refrigerant type and amount. (R-1234yf)

## CONSUMER INFORMATION

This consumer information has been prepared in accordance with regulations issued by the National Highway Traffic Safety Administration of the U.S. Department of Transportation. Your HYUNDAI dealer will help answer any questions you may have as you read this information.

HYUNDAI motor vehicles are designed and manufactured to meet or exceed all applicable safety standards.

For your safety, however, we strongly urge you to read and follow all directions in this Owner's Manual, particularly the information under the headings "**NOTICE**", "**CAUTION**" and "**WARNING**".

If, after reading this manual, you have any questions regarding the operation of your vehicle, please contact the Hyundai Customer Care Center:

Hyundai Customer Care  
P.O. Box 20850  
Fountain Valley, CA 92728  
800-633-5151  
consumeraffairs@hmmausa.com

Hyundai's Customer Care Center representatives are available Monday through Friday, between the hours of 6:00 AM and 5:00 PM PST and Saturday between 6:30 AM and 3:00 PM PST (English). For Customer Care assistance in Spanish or Korean, representatives are available Monday through Friday between 6:30 AM and 3:00 PM PST.



## REPORTING SAFETY DEFECTS

If you believe that your vehicle has a defect which could cause a crash or could cause injury or death, you should immediately inform the National Highway Traffic Safety Administration (NHTSA) in addition to notifying HYUNDAI MOTOR AMERICA.

To contact NHTSA, you may call the Vehicle Safety Hotline toll-free at 1-888-327-4236 (TTY: 1-800-424-9153);

go to <http://www.safercar.gov>;

download the SaferCar mobile application;

or write to: Administrator, NHTSA

1200 New Jersey Ave, SE,

West Building Washington, D.C. 20590.

You can also obtain other information about motor vehicle safety from <http://www.safercar.gov>.

If NHTSA receives similar complaints, it may open an investigation, and if it finds that a safety defect exists in a group of vehicles, it may order a recall and remedy campaign. However, NHTSA cannot become involved in individual problems between you, your dealer, or HYUNDAI MOTOR AMERICA.



## 3. Seats & Safety System

This chapter provides you with important information about how to protect yourself and your passengers. It explains how to properly use your seats and seat belts, and how your air bags work. Additionally, this chapter explains how to properly restrain infants and children in your vehicle.

Important Safety Precautions .....	3-2
Always Wear Your Seat Belt .....	3-2
Restrain All Children .....	3-2
Air Bag Hazards .....	3-2
Driver Distraction .....	3-2
Control Your Speed .....	3-2
Keep Your Vehicle in Safe Condition .....	3-2
Seats .....	3-3
Safety Precautions .....	3-4
Front Seats .....	3-5
Rear Seats .....	3-11
Head Restraints .....	3-12
Seat Warmers .....	3-16
Air Ventilation Seat .....	3-18
Seat Belts .....	3-20
Seat Belt Safety Precautions .....	3-20
Seat Belt Warning Light .....	3-21
Seat Belt Restraint System .....	3-22
Additional Seat Belt Safety Precautions .....	3-28
Care of Seat Belts .....	3-30
Child Restraint System (CRS) .....	3-31
Children Always in the Rear .....	3-31
Selecting a Child Restraint System (CRS) .....	3-32
Installing a Child Restraint System (CRS) .....	3-34
Air Bag - Supplemental Restraint system .....	3-42
Where are the Air Bags? .....	3-44
How does the SRS Air Bag System Operate? .....	3-47
What To Expect After an Air Bag Inflates .....	3-50
Occupant Classification System (OCS) .....	3-51
Why Didn't My Air Bag Go Off in a Collision? .....	3-57
SRS Care .....	3-62
Additional Safety Precautions .....	3-63
Air Bag Warning Labels .....	3-63

## IMPORTANT SAFETY PRECAUTIONS

You will find many safety precautions and recommendations throughout this section, and throughout this manual. The safety precautions in this section are among the most important.

### Always Wear Your Seat Belt

A seat belt is your best protection in all types of accidents. Air bags are designed to supplement seat belts, not to replace them. So even though your vehicle is equipped with air bags, ALWAYS make sure you and your passengers wear your seat belts, and wear them properly.

### Restrain All Children

All children under age 13 should ride in your vehicle properly restrained in a rear seat, not the front seat. Infants and small children should be restrained in an appropriate Child Restraint System. Larger children should use a booster seat with the lap/shoulder belt until they can use the seat belt properly without a booster seat.

### Air Bag Hazards

While air bags can save lives, they can also cause serious or fatal injuries to occupants who sit too close to them, or who are not properly restrained. Infants, young children, and short adults are at the greatest risk of being injured by an inflating air bag. Follow all instructions and warnings in this manual.

### Driver Distraction

Driver distraction presents a serious and potentially deadly danger, especially for inexperienced drivers. Safety should be the first concern when behind the wheel and drivers need to be aware of the wide array of potential distractions, such as drowsiness, reaching for objects, eating, personal grooming, other passengers, and using mobile phones.

Drivers can become distracted when they take their eyes and attention off the road or their hands off the wheel to focus on activities other than driving. To reduce your risk of distraction and an accident:

- Set up your mobile devices (for example, MP3 players, phones, navigation units, etc.) ONLY when your vehicle is parked or safely stopped.
- ONLY use your mobile device when allowed by laws and conditions permit safe use. NEVER text or email while driving. Most countries have laws prohibiting drivers from texting. Some countries and cities also prohibit drivers from using handheld phones.
- NEVER let the use of a mobile device distract you from driving. You have a responsibility to your passengers and others on the road to always drive safely, with your hands on the wheel as well as your eyes and attention on the road.

### Control Your Speed

Excessive speed is a major factor in crash injuries and deaths. Generally, the higher the speed, the greater the risk, but serious injuries can also occur at lower speeds. Never drive faster than is safe for current conditions, regardless of the maximum speed posted.

### Keep Your Vehicle In Safe Condition

Having a tire blowout or a mechanical failure can be extremely hazardous. To reduce the possibility of such problems, check your tire pressures and condition frequently, and perform all regularly scheduled maintenance.

## SEATS

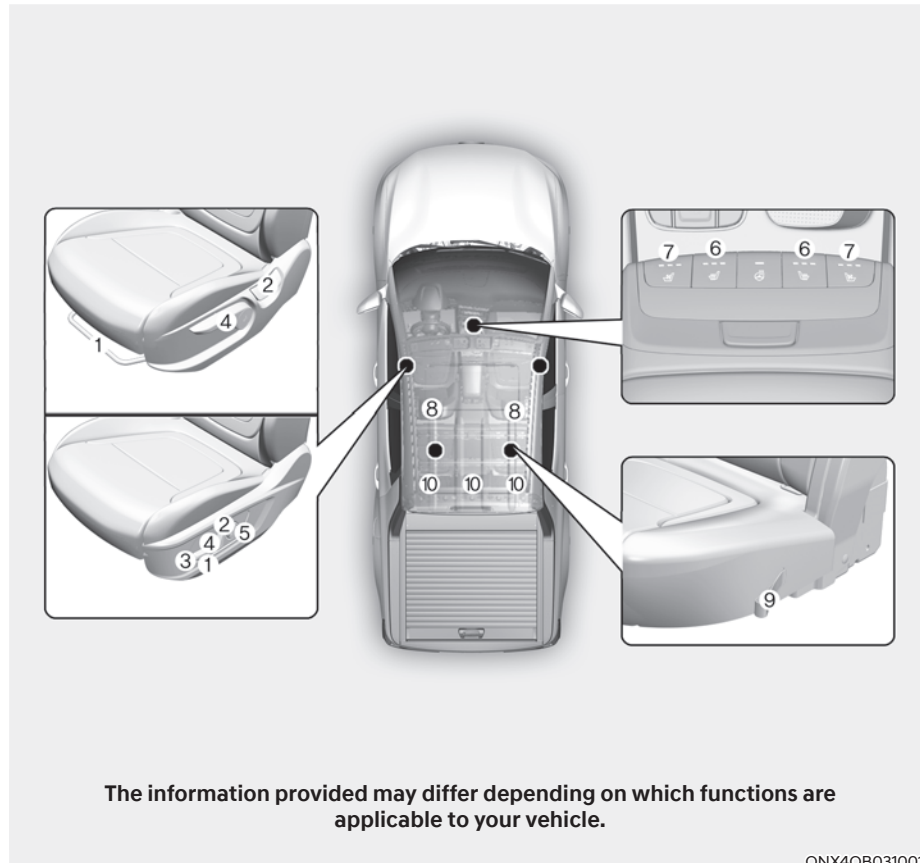
**Front seat**

- (1) Forward and rearward
- (2) Seatback angle
- (3) Seat cushion angle\*
- (4) Seat cushion height
- (5) Lumbar support (Driver's seat)\*
- (6) Seat warmer\*
- (7) Air ventilation seat\*
- (8) Head restraint

**Rear seats**

- (9) Seat cushion strap
- (10) Head restraint

\*: if equipped

### Safety Precautions

Adjusting the seats so that you are sitting in a safe and comfortable position plays an important role for the safety of the driver and passengers, as much as seat belts and air bags when in an accident.



#### **WARNING**

**Do not use a cushion that reduces friction between the seat and the passenger. The passenger's hips may slide under the lap portion of the seat belt during an accident or a sudden stop.**

**Serious or fatal internal injuries could result because the seat belt cannot operate properly.**

#### **Air bags**

You can take steps to reduce the risk of being injured by an inflating air bag. Sitting too close to an air bag greatly increases the risk of injury in the event the air bag inflates.

The National Highway Traffic Safety Administration (NHTSA) recommends that drivers allow at least 10 inches (25cm) between the center of the steering wheel and their chest.



#### **WARNING**

**To reduce the risk of serious injury or death from an inflating air bag, take the following precautions:**

- **Adjust the driver's seat as far to the rear as possible maintaining the ability to control the vehicle.**
- **Adjust the front passenger seat as far to the rear as possible.**
- **Hold the steering wheel by the rim with hands at the 9 o'clock and 3 o'clock positions to minimize the risk of injuries to your hands and arms.**
- **NEVER place anything or anyone between you and the air bag.**
- **Do not allow the front passenger to place feet or legs on the dashboard to minimize the risk of leg injuries.**

#### **Seat belts**

Always fasten your seat belt before starting any trip. At all times, passengers should sit upright and be properly restrained. Infants and small children must be restrained in appropriate Child Restraint Systems. Children who have outgrown a booster seat and adults must be restrained using the seat belts.



#### **WARNING**

**Take the following precautions when adjusting your seat belt:**

- **NEVER use one seat belt for more than one occupant.**
- **Always position the seatback upright with the lap portion of the seat belt snug and low across the hips.**
- **NEVER allow children or small infants to ride on a passenger's lap.**
- **Do not route the seat belt across your neck, across sharp edges, or reroute the shoulder strap away from your body.**
- **Do not allow the seat belt to become caught or jammed.**

## Front Seats



### WARNING

Take the following precautions when adjusting your seat:

- **NEVER** attempt to adjust the seat while the vehicle is moving. The seat could respond with unexpected movement and may cause loss of vehicle control resulting in an accident.
- Do not place anything under the front seats. Loose objects in the driver's foot area could interfere with the operation of the foot pedals, causing an accident.
- Do not allow anything to interfere with the normal position and proper locking of the seatback.
- Do not place a cigarette lighter on the floor or seat. When you operate the seat, gas may exit out of the lighter causing a fire.
- Use extreme caution when picking up small objects trapped under the seats or between the seat and the center console. Your hands might be cut or injured by the sharp edges of the seat mechanism.
- If there are occupants in the rear seats, be careful while adjusting the front seat position.
- Make sure that the seat is locked in place after the adjustment. If not, the seat might move unexpectedly resulting in an accident.



### CAUTION

To prevent injury:

- Do not adjust your seat while wearing your seat belt. Moving the seat cushion forward may cause strong pressure on your abdomen.
- Do not allow your hands or fingers to get caught in the seat mechanisms while the seat is moving.

### Manual adjustment

The front seat can be adjusted by using the levers located underneath the seat cushion. Before driving, adjust the seat to the proper position so that you can easily control the steering wheel, foot pedals and controls on the instrument panel.



### Forward and rearward adjustment

To move the seat forward or rearward:

1. Pull up the seat slide adjustment lever and hold it.
2. Slide the seat to the position you desire.
3. Release the lever and make sure the seat is locked in place. Move forward and rearward without using the lever. If the seat moves, it is not locked properly.

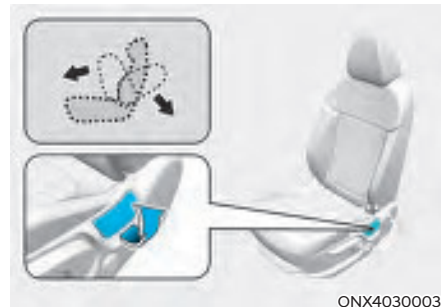

### Seatback angle

To recline the seatback:

1. Lean forward slightly and lift up the seatback lever.
2. Carefully lean back on the seat and adjust the seatback to the position you desire.
3. Release the knob and make sure the seatback is locked in place.

### Reclining seatback

Sitting in a reclined position when the vehicle is in motion can be dangerous. Even when buckled up, the protections of your restraint system (seat belts and/or air bags) is greatly reduced by reclining your seatback.



### WARNING

**NEVER** ride with a reclined seatback when the vehicle is moving.

**Riding with a reclined seatback increases your chance of serious or fatal injuries in the event of a collision or sudden stop.**

**Drivers and passengers should ALWAYS sit well back in their seats, properly belted, and with the seatbacks upright.**



Seat belts must be snug against your hips and chest to work properly. When the seatback is reclined, the shoulder belt cannot do its job because it will not be snug against your chest. Instead, it will be in front of you. During an accident, you could be thrown into the seat belt, causing neck or other injuries. The more the seatback is reclined, the greater chance the passenger's hips will slide under the lap belt or the passenger's neck will strike the shoulder belt.

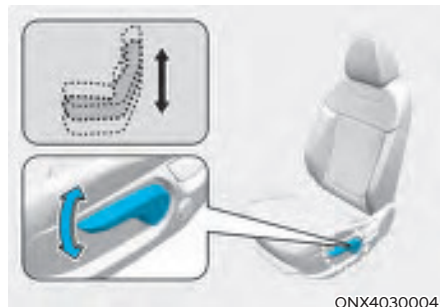

#### Seat cushion height

To change the height of the seat cushion:

- Push down the lever several times, to lower the seat cushion.
- Pull up the lever several times, to raise the seat cushion.

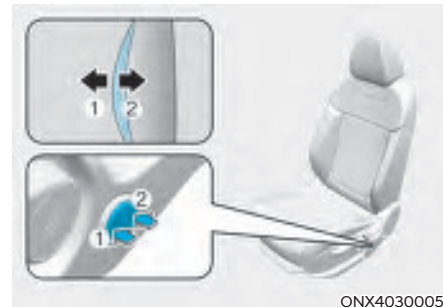

#### Lumbar support (for driver's seat, if equipped)

To adjust the lumbar support:

1. Press the front portion of the switch (1) to increase support or the rear portion of the switch (2) to decrease support.
2. Release the switch once the lumbar support reaches the desired position.

**Power adjustment (for driver's seat, if equipped)**

The driver's seat can be adjusted by using the control switches located on the outside of the seat cushion. Before driving, adjust the seat to the proper position so that you can easily control the steering wheel, foot pedals and controls on the instrument panel.



**WARNING**

**NEVER** allow children in the vehicle unattended. The power seats are operable when the vehicle is turned off.

**NOTICE**

To prevent damage to the seats:

- Always stop adjusting the seats when the seat has been adjusted as far forward or rearward as possible.
- Do not adjust the seats longer than necessary when the vehicle is turned off. This may result in unnecessary battery drain.
- Do not operate two or more seats at the same time. This may result in an electrical malfunction.



**Forward and rearward adjustment**

To move the seat forward or rearward:

1. Push the control switch forward or rearward.
2. Release the switch once the seat reaches the desired position.



#### Seatback angle

To recline the seatback:

1. Push the control switch forward or rearward.
2. Release the switch once the seatback reaches the desired position.

#### Reclining seatback

Sitting in a reclined position when the vehicle is in motion can be dangerous. Even when buckled up, the protections of your restraint system (seat belts and air bags) is greatly reduced by reclining your seatback.



#### **WARNING**

**NEVER ride with a reclined seatback when the vehicle is moving.**

**Riding with a reclined seatback increases your chance of serious or fatal injuries in the event of a collision or sudden stop.**

**Driver and passengers should ALWAYS sit well back in their seats, properly belted, and with the seatbacks upright.**

Seat belts must be snug against your hips and chest to work properly. When the seatback is reclined, the shoulder belt cannot do its job because it will not be snug against your chest. Instead, it will be in front of you. During an accident, you could be thrown into the seat belt, causing neck or other injuries. The more the seatback is reclined, the greater chance the passenger's hips will slide under the lap belt or the passenger's neck will strike the shoulder belt.

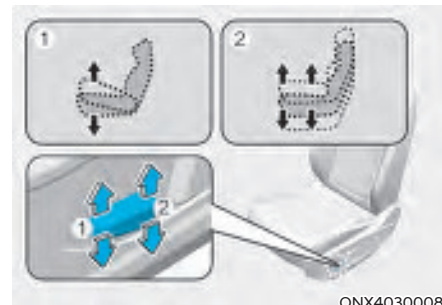

#### Seat cushion tilt (1)

To change the angle of the front part of the seat cushion:

Push the front portion of the control switch up to raise or down to lower the front part of the seat cushion.

Release the switch once the seat reaches the desired position.

#### Seat cushion height (2)

To change the height of the seat cushion:

Push the rear portion of the control switch up to raise or down to lower the height of the seat cushion.

Release the switch once the seat reaches the desired position.



**Lumbar support (for driver's seat, if equipped)**

To adjust the lumbar support:

1. Press the front portion of the switch (1) to increase support or the rear portion of the switch (2) to decrease support.
2. Release the switch once the lumbar support reaches the desired position.

**Seatback pocket**

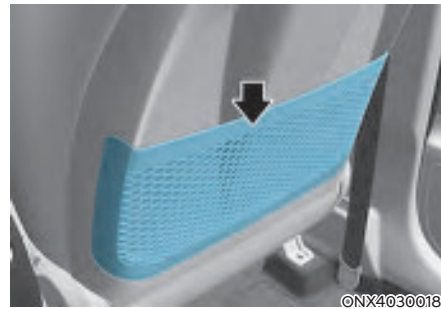

The seatback pocket is provided on the back of the front seatbacks.



**CAUTION**

**Do not put heavy or sharp objects in the seatback pockets. In an accident they could come loose from the pocket and injure occupants.**

## Rear Seats

### Folding the rear seat

The right and left seat bottoms can be folded independently to increase the luggage capacity of the vehicle.



#### WARNING

Be careful when carrying a stack of objects in the second row. If the objects extend higher than the top of the front seatbacks, they could inadvertently slide forward when decelerating and possibly cause injury or damage during sudden stops.



ONX4OB031002

1. Pull the strap to unlock the seat.
2. Lift up the seat bottom.
3. Push the seat bottom firmly against the seatback to lock it into place.

### Unfolding the rear seat



ONX4OB031003

1. Pull the strap to unlock the seat.
2. Carefully lower the seat bottom to the normal seating position. The seat bottom will remain in place under its own weight.



#### WARNING

Make sure the engine is off, the shift lever is in P (Park), and the parking brake is securely applied whenever loading or unloading cargo. Failure to take these steps may allow the vehicle to move if the shift lever is inadvertently moved to another position.



#### CAUTION

Be careful when loading cargo through the rear passenger seats to prevent damage to the vehicle interior.



#### WARNING

Cargo should always be secured to prevent it from being thrown about the vehicle in a collision and causing injury to the vehicle occupants. Do not place objects in the rear seats, since they cannot be properly secured and may hit the front seat occupants in a collision.

## Head Restraints

The vehicle's front and rear (second row and/or third row) seats have adjustable head restraints. The head restraints provide comfort for passengers, but more importantly they are designed to help protect passengers from whiplash and other neck and spinal injuries during an accident, especially in a rear impact collision.

### WARNING

To help reduce the risk of serious injury or death in an accident, take the following precautions when adjusting your head restraints:

- Always properly adjust the head restraints for all passengers **BEFORE** starting the vehicle.
- **NEVER** let anyone ride in a seat with the head restraints removed or reversed.



- Adjust the head restraints so the middle of the head restraints is at the same height as the height of the top of the eyes.
- **NEVER** adjust the head restraints position of the driver's seat when the vehicle is in motion.
- Adjust the head restraints as close to the passenger's head as possible. Do not use a seat cushion that holds the body away from the seatback.
- Make sure the head restraints locks into position after adjusting it.

### WARNING

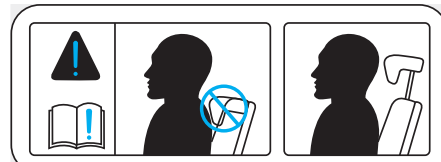

OTL035061

When sitting on the rear seat, do not adjust the height of the head restraints to the lowest position.

### CAUTION

When there is no occupant in the rear seats, adjust the height of the head restraints to the lowest position. The rear seat head restraints can reduce the visibility of the rear area.

### **NOTICE**

To prevent damage, **NEVER** hit or pull on the head restraints.

### Front seat head restraints

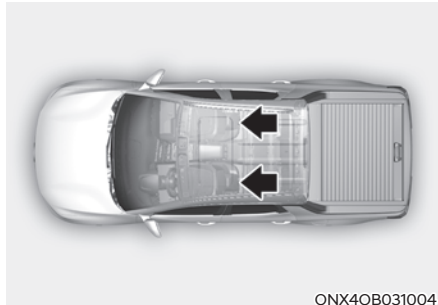

ONX4OB031004

The driver's and front passenger's seats are equipped with adjustable head restraint for the passengers safety and comfort.

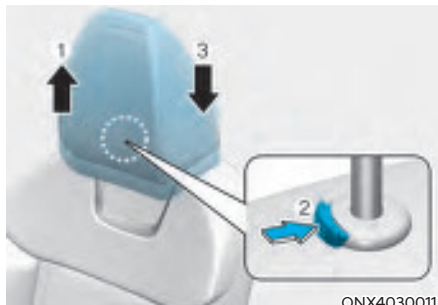

ONX4030011

#### Adjusting the height up and down

To raise the head restraint:

1. Pull it up to the desired position (1).

To lower the head restraint:

1. Push and hold the release button (2) on the head restraint support.
2. Lower the head restraint to the desired position (3).

### NOTICE



©HI038136

If you recline the seatback towards the front with the head restraint and seat cushion raised, the head restraint may come in contact with the sunvisor or other parts of the vehicle.

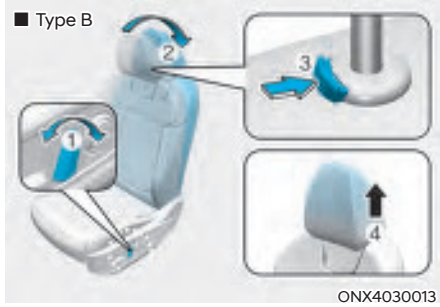
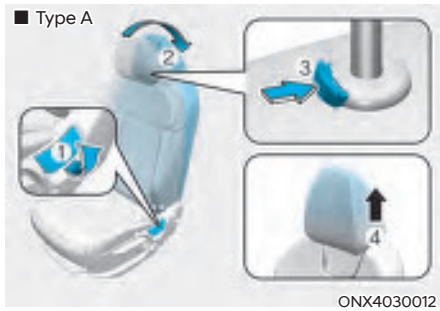

**Removal/Reinstall**

To remove the head restraint:

1. Recline the seatback (2) with the seatback angle lever (1).
2. Raise the head restraint as far as it can go.
3. Press the head restraint release button (3) while pulling the head restraint up (4).

**⚠ WARNING**

**NEVER** allow anyone to travel in a seat with the head restraint removed.

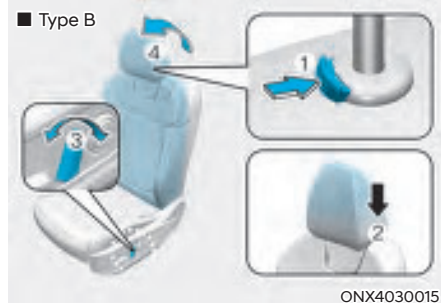
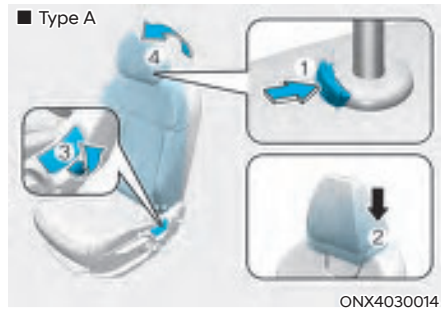

To reinstall the head restraint :

1. Recline the seatback.
2. Put the head restraint poles (2) into the holes while pressing the release button (1).
3. Adjust the head restraint to the appropriate height.
4. Recline the seatback (4) with the seatback angle lever (3).

**⚠ WARNING**

**Always** make sure the head restraint locks into position after reinstalling and adjusting it properly.



### Rear seat head restraint

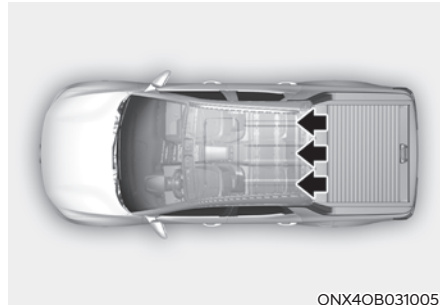

ONX4OB031005

The rear seats are equipped with head restraint in all the seating positions for the passenger's safety and comfort.

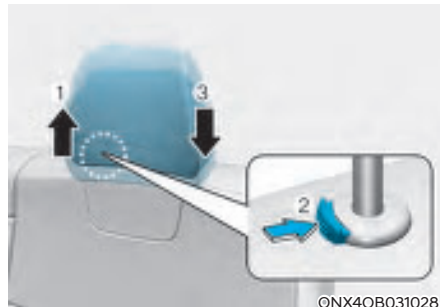

ONX4OB031028

#### Adjusting the height up and down

To raise the head restraint:

1. Pull it up to the desired position (1).

To lower the head restraint:

1. Push and hold the release button (2) on the head restraint support.
2. Lower the head restraint to the desired position (3).



ONX4OB031029

#### Removal/Reinstallation

To remove the head restraint:

1. Raise the head restraint as far as it can go.
2. Press the head restraint release button (1) while pulling the head restraint up (2).

To reinstall the head restraint:

1. Put the head restraint poles into the holes (3) while pressing the release button (1).
2. Adjust the head restraint to the appropriate height.

### Seat Warmers (if equipped)

Seat warmers are provided to warm the front seats during cold weather.

During mild weather or under conditions where the operation of the seat warmer is not needed, keep the seat warmers OFF.



#### **WARNING**

The seat warmers can cause a **SERIOUS BURN**, even at low temperatures and especially if used for long periods of time.

Passengers must be able to feel if the seat is becoming too warm so they can turn it off, if needed.

People who cannot detect temperature change or pain to the skin should use extreme caution, especially the following types of passengers:

- Infants, children, elderly or disabled persons, or hospital outpatients.
- People with sensitive skin or who burn easily.
- Fatigued individuals.
- Intoxicated individuals.
- People taking medication that can cause drowsiness or sleepiness.



#### **WARNING**

**NEVER** place anything on the seat that insulates against heat when the seat warmer is in operation, such as a blanket or seat cushion. This may cause the seat warmer to overheat, causing a burn or damage to the seat.

#### **NOTICE**

To prevent damage to the seat warmers and seats:

- Never use a solvent such as paint thinner, benzene, alcohol or gasoline to clean the seats.
- Do not place heavy or sharp objects on seats equipped with seat warmers.
- Do not change the seat cover. It may damage the seat warmer.



While the engine is running, push either of the switches to warm the driver's seat or front passenger's seat.

During mild weather or under conditions where the operation of the seat warmer is not needed, keep the switches in the OFF position.

- Manual temperature control  
Each time you push the switch, the temperature setting of the seat is changed as follows:

- Front seat

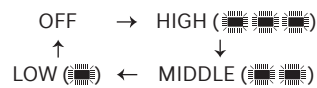

- Rear seat



- Automatic temperature control

The seat warmer starts to automatically control the seat temperature in order to prevent low-temperature burns after being manually turned ON.

- Front seat

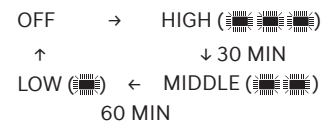

- Rear seat

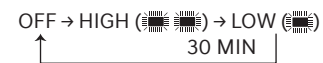

If HIGH temperature is manually selected again, the temperature will be controlled automatically.

- When pressing the switch for more than 1.5 seconds with the seat warmer operating, the seat warmer will turn OFF.
- The seat warmer defaults to the OFF position whenever the ignition switch is ON.
- Auto Comfort Control (for driver's seat) (if equipped)
  - The seat warmer automatically controls the seat temperature depending on the ambient temperature and the set climate control temperature when the engine is running. If the seat warmer switch is pushed, the seat warmer will have to be controlled manually.

To use this function, it must be activated from the Settings menu in the AV/AVN system screen.
  - The seat warmer defaults to the OFF position whenever the ignition switch is ON. However, if the Auto Comfort Control function is ON, the driver's seat warmer will turn on and off depending on the ambient temperature and the set climate control temperature.

**For more details, refer to the separately supplied Infotainment manual with your vehicle.**

### **i** Information

With the seat warmer switch in the ON position, the heating system in the seat turns off or on automatically depending on the seat temperature.

### Air Ventilation Seat (if equipped)



The air ventilation seats are provided to cool the front seats by blowing air through small vent holes on the surface of the seat cushions and seatbacks.

When the operation of the air ventilation seat is not needed, keep the switches in the OFF position.

While the engine is running, push the switch to cool the driver's seat or the front passenger's seat.

### **NOTICE**

**To prevent damage to the air ventilation seats:**

- **Never use a solvent such as paint thinner, benzene, alcohol or gasoline to clean the seats.**
- **Avoid spilling liquids on the surface of the front seats and seatbacks; this may cause the air vent holes to block and not work properly.**
- **Do not place materials such as plastic bags or newspapers under the seats. They may block the air intake causing malfunction of the air vent.**
- **Do not change the seat covers. It may damage the air ventilation seat.**
- **If the air vents do not operate, restart the vehicle. If there is no change, have the vehicle inspected by an authorized HYUNDAI dealer.**

- Each time you push the switch, the airflow changes as follows:

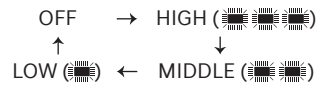

- When pressing the switch for more than 1.5 seconds with the air ventilation seat operating, the operation will turn OFF.
- The air ventilation seats defaults to the OFF position whenever the ignition switch is placed to the ON position.
- Auto Comfort Control (for driver's seat) (if equipped)
  - The air ventilation seats automatically controls the seat temperature depending on the ambient temperature and the set climate control temperature when the engine is running. If the air ventilation seats switch is pushed, the air ventilation seats will have to be controlled manually.  
To use this function, it must be activated from the Settings menu in the AV/AVN system screen.
  - The air ventilation seats defaults to the OFF position whenever the ignition switch is ON. However, if the Auto Comfort Control function is ON, the air ventilation seats will turn on and off depending on the ambient temperature and the set climate control temperature.

**For more details, refer to the separately supplied Infotainment manual with your vehicle.**

## SEAT BELTS

This section describes how to use the seat belts properly. It also describes some of the things not to do when using seat belts.

### Seat Belt Safety Precautions

Always fasten your seat belt and make sure all passengers have fastened their seat belts before starting any trip. Air bags are designed to supplement the seat belt as an additional safety device, not a replacement. Most countries require all occupants of a vehicle to wear seat belts.



#### WARNING

Seat belts must be used by **ALL** passengers whenever the vehicle is moving. Take the following precautions when adjusting and wearing seat belts:

- Children under the age of 13 should be properly restrained in the rear seats.
- Never allow children to ride in the front passenger seat, unless the air bag is deactivated. If a child is seated in the front passenger seat, move the seat as far back as possible and properly restrain them in the seat.
- **NEVER** allow an infant or child to be carried on an occupant's lap.
- **NEVER** ride with the seatback reclined when the vehicle is moving.
- Do not allow children to share a seat or seat belt.
- Do not wear the shoulder belt under your arm or behind your back.

- **NEVER** wear a seat belt over fragile objects. If there is a sudden stop or impact, the seat belt can damage it.
- Do not use the seat belt if it is twisted. A twisted seat belt will not protect you properly in an accident.
- Do not use a seat belt if the webbing or hardware is damaged.
- Do not latch the seat belt into the buckles of other seats.
- **NEVER** unfasten the seat belt while driving. This may cause loss of vehicle control resulting in an accident.
- Make sure there is nothing in the buckle interfering with the seat belt latch mechanism. This may prevent the seat belt from fastening securely.
- No modifications or additions should be made by the user which will either prohibit the seat belt adjusting devices from operating to remove slack, or prohibit the seat belt assembly from being adjusted to remove slack.



#### WARNING

Damaged seat belts and seat belt assemblies will not operate properly. Always replace:

- Frayed, contaminated, or damaged webbing.
- Damaged hardware.
- The entire seat belt assembly after it has been worn in an accident, even if damage to webbing or assembly is not apparent.

### Seat Belt Warning Light

#### Seat belt warning light (for driver's seat)



As a reminder to the driver, the seat belt warning light will illuminate for approximately 6 seconds each time the ignition is ON position regardless of belt fastening. At this time, if the seat belt is not fastened, a warning chime will sound for 6 seconds.

If you continue not to fasten the seat belt and you drive over 6 mph (9 km/h), the warning light will stay illuminated.

If you continue not to fasten the seat belt and you drive over 12 mph (20 km/h), the seat belt warning chime will sound for approximately 100 seconds and the corresponding warning light will blink.

If you unfasten the seat belt while driving under 12 mph (20 km/h), the seat belt warning light will illuminate until the seat belt is fastened.

If you unfasten the seat belt while driving over 12 mph (20 km/h), the seat belt warning chime will sound for approximately 100 seconds and the corresponding warning light will blink.

#### Seat belt warning light (for front passenger's seat)

As a reminder to the front passenger, the front passenger's seat belt warning lights will illuminate for approximately 6 seconds each time the ignition is ON regardless of belt fastening. If you continue not to fasten the seat belt and you drive over 6 mph (9 km/h), the warning light will stay illuminated.

If you continue not to fasten the seat belt and you drive over 12 mph (20 km/h), the seat belt warning chime will sound for approximately 100 seconds and the corresponding warning light will blink.

If you unfasten the seat belt while driving under 12 mph (20 km/h), the seat belt warning light will illuminate until the seat belt is fastened.

If you unfasten the seat belt while driving over 12 mph (20 km/h), the seat belt warning chime will sound for approximately 100 seconds and the corresponding warning light will blink.

#### **WARNING**

**Riding in an improper position adversely affects the front passenger's seat belt warning system. It is important for the driver to instruct the passenger to properly be seated as instructed in this manual.**

#### **Information**

- Although the front passenger seat is not occupied, the seat belt warning light will blink or illuminate for 6 seconds.
- The front passenger's seat belt warning may operate when luggage is placed on the front passenger seat.

## Seat Belt Restraint System

### WARNING



Improperly positioned seat belts may increase the risk of serious injury in an accident. Take the following precautions when adjusting the seat belt:

- Position the lap portion of the seat belt as low as possible across your hips, not on your waist, so that it fits snugly. This allows your strong pelvic bones to absorb the force of the crash, reducing the chance of internal injuries.
- Position one arm under the shoulder belt and the other over the belt, as shown in the illustration.
- Always position the shoulder belt anchor into the locked position at the appropriate height.
- Never position the shoulder belt across your neck or face.

### *Front Seat Belt – Driver's 3point system with emergency locking retractor*



#### To fasten your seat belt:

Pull it out of the retractor and insert the metal tab (1) into the buckle (2). There will be an audible “click” when the tab locks into the buckle.



You should place the lap belt (1) portion across your hips and the shoulder belt (2) portion across your chest.

The seat belt automatically adjusts to the proper length after the lap belt portion is adjusted manually so that it fits snugly around your hips. If you lean forward in a slow, easy motion, the belt will extend and move with you.

If there is a sudden stop or impact, the belt will lock into position. It will also lock if you try to lean forward too quickly.



### **i** Information

If you are not able to smoothly pull enough of the seat belt out from the retractor, firmly pull the seat belt out and release it. After release, you will be able to pull the belt out smoothly.

#### Height adjustment

You can adjust the height of the shoulder belt anchor to one of the four different positions for maximum comfort and safety.

The shoulder portion should be adjusted so it lies across your chest and midway over your shoulder nearest the door, not over your neck.

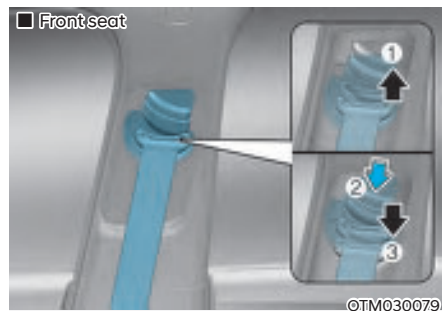

To adjust the height of the seat belt anchor, lower or raise the height adjuster into an appropriate position.

To raise the height adjuster, pull it up (1). To lower it, push it down (3) while pressing the height adjuster button (2).

Release the button to lock the anchor into position. Try sliding the height adjuster to make sure that it has locked into position.



#### To release your seat belt:

Press the release button (1) in the locking buckle.

Once released, the belt should automatically draw back into the retractor. If this does not happen, check the belt to be sure it is not twisted, then try again.

### **Rear Seat Belt – Passenger’s 3point system with convertible locking retractor**

This type of seat belt combines the features of both an emergency locking retractor seat belt and an automatic locking retractor seat belt. Convertible retractor type seat belts are installed in the rear seat positions to help accommodate the installation of child restraint systems. Although a convertible retractor is also installed in the front passenger seat position, NEVER place any infant/child restraint system in the front seat of the vehicle.

#### **To fasten your seat belt:**

Pull the seat belt out of the retractor and insert the metal tab into the buckle. There will be an audible “click” when the tab locks into the buckle. When not securing a child restraint, the seat belt operates in the same way as the driver’s seat belt (Emergency Locking Retractor Type). It automatically adjusts to the proper length only after the lap belt portion of the seat belt is adjusted manually so that it fits snugly across your hips.

When the seat belt is fully extended from the retractor to allow the installation of a child restraint system, the seat belt operation changes to allow the belt to retract, but not to extend (Automatic Locking Retractor Type). Refer to the “Using a Child Restraint System” section in this chapter.



#### **To release your seat belt:**

Press the release button (1) in the locking buckle.

When it is released, the belt should automatically draw back into the retractor. If this does not happen, check the belt to be sure it is not twisted, then try again.

#### **NOTICE**

Although the seat belt retractor provides the same level of protection for seated passengers in either emergency or automatic locking modes, the emergency locking mode allows seated passengers to move freely in their seat while keeping some tension on the belt. During a collision or sudden stop, the retractor automatically locks the belt to help restrain your body.

To deactivate the automatic locking mode, unbuckle the seat belt and allow the belt to fully retract.

### Second row center seatbelt (3-point rear center seat belt)



1. Insert the tongue plate (1) into the buckle (2) until an audible “click” is heard, indicating the latch is locked. Make sure the belt is not twisted.

When using the rear center seat belt, the buckle with the “CENTER” mark must be used.

#### Information

If you are not able to pull out the safety belt from the retractor, firmly pull the belt out and release it. After release, you will be able to pull the belt out smoothly.

#### WARNING

Make sure that the seatback is locked in place when using the rear center seat belt.

If not, the seatback may move when there is a sudden stop or collision, which could result in serious injury.

### Stowing the rear seat belt

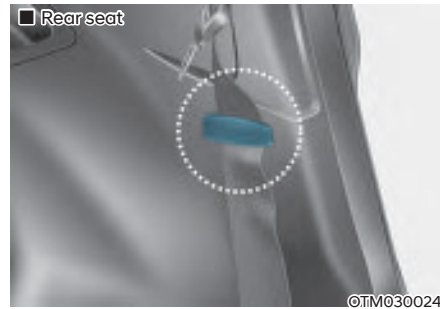

- Routing the seat belt webbing through the rear seat belt guides will help keep the belts from being trapped behind or under the seats. After inserting the seat belt, tighten the belt webbing by pulling it up.

#### CAUTION

When using the seat belt, use it after taking it out of the guides.

If you pull the seat belt when it is stored in the guides, it may damage the guides and/or belt webbing.

**Pre-tensioner seat belt (Driver and front passenger)**



Your vehicle is equipped with driver's Pre-tensioner Seat Belts (Retractor Pretensioner and Emergency Fastening Device System). The purpose of the pre-tensioner is to make sure the seat belts fit tightly against the occupant's body in certain frontal or side collision(s). The Emergency Fastening Device System may be activated in certain crashes where the frontal collision(s) is severe enough, together with the air bags.

When the vehicle stops suddenly, or if the occupant tries to lean forward too quickly, the seat belt retractor will lock into position. In certain frontal or side collision(s), the pre-tensioner will activate and pull the seat belt into tighter contact against the occupant's body.

(1) Retractor Pretensioner

The purpose of the retractor pre-tensioner is to make sure that the shoulder belts fit in tightly against the occupant's upper body in certain frontal or side collision(s).

(2) Emergency Fastening Device System

The purpose of the Emergency Fastening Device System is to make sure that the pelvic belts fit in tightly against the occupant's lower body in certain frontal collision(s).

**WARNING**

- **Always wear your seat belt and sit properly in your seat.**
- **Do not use the seat belt if it is loose or twisted. A loose or twisted seat belt will not protect you properly in an accident.**
- **Do not place anything near the buckle. This may adversely affect the buckle and cause it to function improperly.**
- **Always replace your pre-tensioners after activation or an accident.**
- **NEVER inspect, service, repair or replace the pre-tensioners yourself. This must be done by an authorized HYUNDAI dealer.**
- **Do not hit the seat belt assemblies.**

**⚠ WARNING**

Do not touch the pre-tensioner seat belt assemblies for several minutes after they have been activated. When the pre-tensioner seat belt mechanism deploys during a collision, the pre-tensioner can become hot and can burn you.

**⚠ CAUTION**

Body work on the front area of the vehicle may damage the pre-tensioner seat belt system. Therefore, have the system to be serviced by an authorized HYUNDAI dealer.

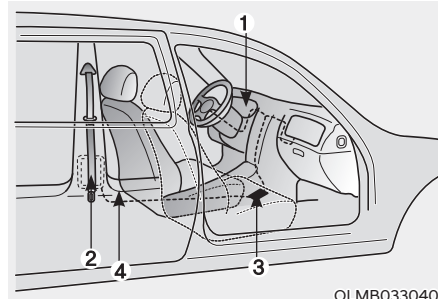

The Pre-Tensioner Seat Belt System consists mainly of the following components. Their locations are shown in the illustration above:

- (1) SRS air bag warning light
- (2) Retractor pre-tensioner
- (3) SRS control module
- (4) Emergency fastening device

### **NOTICE**

The sensor that activates the SRS control module is connected with the pre-tensioner seat belts. The SRS air bag warning light on the instrument cluster will illuminate for approximately 3~6 seconds after the ignition switch is in the ON position, and then it should turn off.

If the pre-tensioner is not working properly, the warning light will illuminate even if the SRS air bag is not malfunctioning. If the warning light does not illuminate, stays illuminated or illuminates when the vehicle is being driven, have an authorized HYUNDAI dealer inspect the pre-tensioner seat belts and SRS air bags as soon as possible.

### **i** Information

- Pre-tensioner seat belts may be activated in certain frontal or side collisions or rollover situations (if equipped with rollover sensor).
- When the pre-tensioner seat belts are activated, a loud noise may be heard and fine dust, which may appear to be smoke, may be visible in the passenger compartment. These are normal operating conditions and are not hazardous.
- Although it is non-toxic, the fine dust may cause skin irritation and should not be inhaled for prolonged periods. Wash all exposed skin areas thoroughly after an accident in which the pre-tensioner seat belts were activated.

### **Additional Seat Belt Safety Precautions**

#### ***Seat belt use during pregnancy***

The seat belt should always be used during pregnancy. The best way to protect your unborn child is to protect yourself by always wearing the seat belt. Pregnant women should always wear a lap-shoulder seat belt. Place the shoulder belt across your chest, routed between your breasts and away from your neck. Place the lap belt below your belly so that it fits SNUGLY across your hips and pelvic bone, under the rounded part of the belly.



### **WARNING**

To reduce the risk of serious injury or death to an unborn child during an accident, pregnant women should **NEVER** place the lap portion of the seat belt above or over the area of the abdomen where the unborn child is located.

#### ***Seat belt use and children***

##### **Infant and small children**

Most countries have Child Restraint System laws which require children to travel in approved Child Restraint System devices, including booster seats. The age at which seat belts can be used instead of Child Restraint System differs among countries, so you should be aware of the specific requirements in your country, and where you are travelling. Infant and Child Restraint System must be properly placed and installed in a rear seat.

For more information refer to the “Child Restraint Systems” section in this chapter.

**WARNING**

**ALWAYS properly restrain infants and small children in a Child Restraint System appropriate for the child's height and weight.**

**To reduce the risk of serious injury or death to a child and other passengers, NEVER hold a child in your lap or arms when the vehicle is moving. The violent forces created during an accident will tear the child from your arms and throw the child against the interior of the vehicle.**

Small children are best protected from injury in an accident when properly restrained in the rear seat by a Child Restraint System that meets the requirements of the Safety Standards of your country. Before buying any Child Restraint System, make sure that it has a label certifying that it meets Safety Standard of your country.

The Child Restraint System must be appropriate for your child's height and weight. Check the label on the Child Restraint System for this information. Refer to "Child Restraint Systems" section in this chapter.

**Larger children**

Children under age 13 and who are too large for a booster seat should always occupy the rear seat and use the available lap/shoulder belts. A seat belt should lie across the upper thighs and be snug across the shoulder and chest to restrain the child safely. Check belt fit periodically. A child's squirming could put the belt out of position. In the event of an accident, children are afforded the best safety restrained by a proper Child Restraint System in the rear seats.

If a larger child over age 13 must be seated in the front seat, the child must be securely restrained by the available lap/shoulder belt and the seat should be placed in the rearmost position.

If the shoulder belt portion slightly touches the child's neck or face, try placing the child closer to the center of the vehicle. If the shoulder belt still touches their face or neck, they need to be returned to an appropriate booster seat in the rear seat.

**WARNING**

- **Always make sure larger children's seat belts are worn and properly adjusted.**
- **NEVER allow the shoulder belt to contact the child's neck or face.**
- **Do not allow more than one child to use a single seat belt.**

***Seat belt use and injured people***

A seat belt should be used when an injured person is being transported. Consult a physician for specific recommendations.

### ***One person per belt***

Two people (including children) should never attempt to use a single seat belt. This could increase the severity of injuries in case of an accident.

### ***Do not lie down***

Sitting in a reclined position when the vehicle is in motion can be dangerous. Even when buckled up, the protections of your restraint system (seat belts and/or air bags) is greatly reduced by reclining your seatback.

Seat belts must be snug against your hips and chest to work properly.

During an accident, you could be thrown into the seat belt, causing neck or other injuries.

The more the seat back is reclined, the greater the chance for the passenger's hips to slide under the lap belt or the passenger's neck to strike the shoulder belt.



### **WARNING**

- **NEVER ride with a reclined seatback when the vehicle is moving.**
- **Riding with a reclined seatback increases your chance of serious or fatal injuries in the event of a collision or sudden stop.**
- **Driver and passengers should always sit well back in their seats, properly belted, and with the seatbacks upright.**

### **Care of Seat Belts**

Seat belt systems should never be disassembled or modified. In addition, care should be taken to assure that seat belts and belt hardware are not damaged by seat hinges, doors or other abuse.

### ***Periodic inspection***

All seat belts should be inspected periodically for wear or damage of any kind. Any damaged parts should be replaced as soon as possible.

### ***Keep belts clean and dry***

Seat belts should be kept clean and dry. If belts become dirty, they can be cleaned by using a mild soap solution and warm water. Bleach, dye, strong detergents or abrasives should not be used because they may damage and weaken the fabric.

### ***When to replace seat belts***

The entire seat belt assembly or assemblies should be replaced if the vehicle has been involved in an accident. This should be done even if no damage is visible. Additional questions concerning seat belt operation should be directed to an authorized HYUNDAI dealer.



## CHILD RESTRAINT SYSTEM (CRS)

### Children Always in the Rear



#### WARNING

**Always properly restrain children in the vehicle. Children of all ages are safer when restrained in the rear seat. A child riding in the front passenger seat can be forcefully struck by an inflating air bag resulting in SERIOUS INJURY or DEATH.**

Children under age 13 should always ride in the rear seats and must always be properly restrained to minimize the risk of injury in an accident, sudden stop or sudden maneuver.

According to accident statistics, children are safer when properly restrained in the rear seats than in the front seat. **Even with air bags, children can be seriously injured or killed.** Children too large for a Child Restraint System must use the seat belts provided.

All 50 states have child restraint laws which require children to travel in approved Child Restraint Systems.

The laws governing the age or height/weight restrictions at which seat belts can be used instead of Child Restraint System differs among states, so you should be aware of the specific requirements in your country, and where you are travelling.

Child Restraint Systems must be properly placed and installed in the rear seat. You must use a commercially available Child Restraint System that meets the requirements of the Federal Motor Vehicle Safety Standards (FMVSS 213).

Child Restraint Systems are generally designed to be secured in a vehicle seat by lap belt portion of a lap/shoulder belt, or by a LATCH system in the rear seats of the vehicle.

### Child Restraint System (CRS)

Infants and younger children must be restrained in an appropriate rearward-facing or forward-facing CRS that has first been properly secured to the seat of the vehicle. Read and comply with the instructions for installation and use provided by the manufacturer of the Child Restraint System.



#### WARNING

**An improperly secured child restraint can increase the risk of SERIOUS INJURY or DEATH in an accident. Always take the following precautions when using a Child Restraint System:**

- **NEVER** install a child or infant restraint in the front passenger's seat.
- Always properly secure the child restraint to a rear seat of the vehicle.
- Always follow the child restraint system manufacturer's instructions for installation and use.
- Always properly restrain your child in the child restraint.
- If the vehicle head restraint prevents proper installation of a child seat (as described in the child restraint system manual), the head restraint of the respective seating position shall be readjusted or entirely removed.
- Do not use an infant carrier or a child safety seat that "hooks" over a seatback, it may not provide adequate protection in an accident.
- After an accident, have an authorized HYUNDAI dealer check the child restraint system, seat belts, tether anchors and lower anchors.

### Selecting a Child Restraint System (CRS)

When selecting a Child Restraint System for your child, always:

- Make sure the Child Restraint System has a label certifying that it meets applicable Federal Motor Vehicle Safety Standards (FMVSS 213).
- Select a Child Restraint System based on your child's height and weight. The required label or the instructions for use typically provide this information.
- Select a Child Restraint System that fits the vehicle seating position where it will be used.
- Read and comply with the warnings and instructions for installation and use provided with the Child Restraint System.

### Child Restraint System types

There are three main types of Child Restraint Systems: rearward-facing, forward-facing and booster Child Restraint Systems.

They are classified according to the child's age, height and weight.

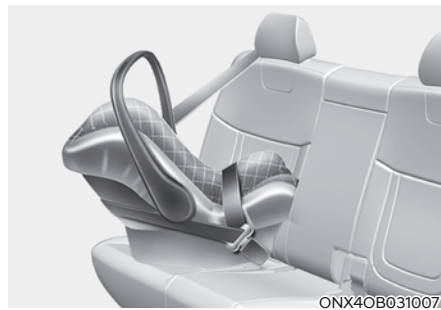

### Rearward-facing Child Restraint System

A rearward-facing Child Restraint System provides restraint with the seating surface against the back of the child. The harness system holds the child in place, and in an accident, acts to keep the child positioned in the Child Restraint Systems and reduce the stress to the fragile neck and spinal cord.

All children under the age of one year must always ride in a rearward-facing Child Restraint System. Convertible and 3-in-1 Child Restraint Systems typically have higher height and weight limits for the rearward-facing position, allowing you to keep your child rearward-facing for a longer period of time.

Keep using Child Restraint Systems in the rearward-facing position as long as children fit within the height and weight limits allowed by the Child Restraint System's manufacturer.

Continue using Child Restraint Systems in the rearward-facing position as long as children fit within the height and weight limits allowed by the Child Restraint System's manufacturer. It's the best way to keep them safe. Once your child has outgrown the rearward-facing Child Restraint System, your child is ready for a forward-facing Child Restraint System with a harness.



#### **WARNING**

**NEVER install a child or infant restraint in the front passenger's seat.**

**Placing a rearward-facing child restraint in the front seat can result in SERIOUS INJURY or DEATH if the child restraint is struck by an inflating air bag.**



ONX4OB031008

#### **Forward-facing Child Restraint System**

A forward-facing Child Restraint System provides restraint for the child's body with a harness. Keep children in a forward-facing Child Restraint System with a harness until they reach the top height or weight limit allowed by your Child Restraint System's manufacturer.

Once your child outgrows the forward-facing Child Restraint System, your child is ready for a booster seat.

#### **Booster seats**

A booster seat is a Child Restraint System designed to improve the fit of the vehicle's seat belt system. A booster seat positions the seat belt so that it fits properly over the stronger parts of your child's body. Keep your children in booster seats until they are big enough to fit in a seat belt properly.

For a seat belt to fit properly, the lap belt must lie comfortable across the upper thighs, not the stomach. The shoulder belt should lie comfortable across the shoulder and chest and not across the neck or face. Children under age 13 must always be properly restrained to minimize the risk of injury in an accident, sudden stop or sudden maneuver.

## Installing a Child Restraint System (CRS)



### WARNING

Before installing your Child Restraint System always:

**Read and follow the instructions provided by the manufacturer of the Child Restraint System.**

**Failure to follow all warnings and instructions could increase the risk of the SERIOUS INJURY or DEATH if an accident occurs.**



### WARNING

**If the vehicle head restraint prevents proper installation of a Child Restraint System, the head restraint of the respective seating position shall be readjusted or entirely removed.**

After selecting a proper Child Restraint System for your child and checking that the Child Restraint System fits properly on the seating position, there are three general steps for a proper installation:

- **Properly secure the Child Restraint System to the vehicle.** All Child Restraint Systems must be secured to the vehicle with the lap belt or lap part of a lap/shoulder part of a lap/shoulder belt or with the LATCH system.

- **Make sure the Child Restraint System is firmly secured.** After installing a Child Restraint System to the vehicle, push and pull the seat forward and from side-to-side to verify that it is securely attached to the seat. A Child Restraint System secured with a seat belt should be installed as firmly as possible. However, some side-to-side movement can be expected.

When installing a Child Restraint System, adjust the vehicle seat and seatback (up and down, forward and rearward) so that your child fits in the Child Restraint System in a comfortable manner.

- **Secure the child in the Child Restraint System.** Make sure the child is properly strapped in the Child Restraint System according to the Child Restraint System manufacturer's instructions.



### CAUTION

**A Child Restraint System in a closed vehicle can become very hot. To prevent burns, check the seating surface and buckles before placing your child in the Child Restraint System.**

### ***Lower Anchors and Tether for Children (LATCH System)***

The LATCH system holds a Child Restraint System during driving and in an accident. This system is designed to make installation of the Child Restraint System easier and reduce the possibility of improperly installing your Child Restraint System. The LATCH system uses anchors in the vehicle and attachments on the Child Restraint System. The LATCH system eliminates the need to use seat belts to secure the Child Restraint System to the rear seats.

Lower anchors are metal bars built into the vehicle. There are two lower anchors for each LATCH seating position that will accommodate a Child Restraint System with lower attachments.

To use the LATCH system in your vehicle, you must have a Child Restraint System with LATCH attachments.

The Child Restraint System manufacturer will provide you with instructions on how to use the Child Restraint System with its attachments for the LATCH anchorages.

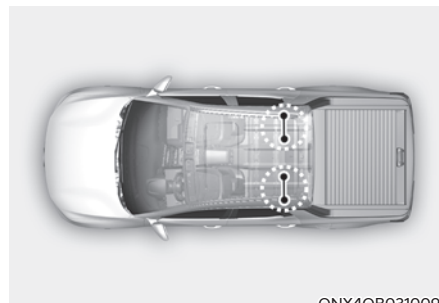

ONX4OB031009

LATCH anchors have been provided in the left and right outboard rear seating positions. Their locations are shown in the illustration. There are no LATCH anchors provided for the center rear seating position.

### **WARNING**

**Do not attempt to install a Child Restraint System using LATCH anchors in the rear center seating position. There are no LATCH anchors provided for this seat. Using the outboard seat anchors can damage the anchors which may break or fail in a collision resulting in serious injury or death.**

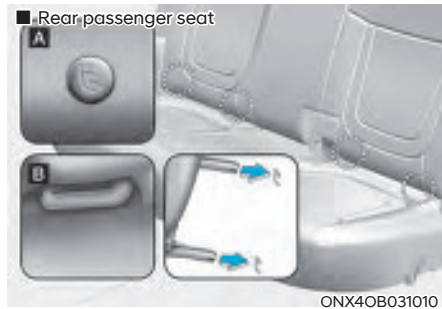

[A] : Lower Anchor Position Indicator  
[B] : Lower Anchor

The lower anchor position indicator symbols are located on the left and right rear seat backs to identify the position of the lower anchors in your vehicle (see arrows in illustration).

The LATCH anchors are located between the seatback and the seat cushion of the rear seat left and right outboard seating positions.



### **WARNING**

**Before installing the Child Restraint System, make sure that there are no objects (for example, toy, pen, wire) around the lower anchor area. Those objects may damage either the seat belt system or the Child Restraint System during the installment procedure. If necessary, have the vehicle inspected by an authorized HYUNDAI dealer.**

### **Securing a Child Restraint System with the “LATCH Anchors System”**

To install a LATCH-compatible Child Restraint System in either of the rear outboard seating positions:

1. Move the seat belt buckle away from the lower anchors.
2. Move any other objects away from the anchorages that could prevent a secure connection between the Child Restraint System and the lower anchors.
3. Place the Child Restraint System on the vehicle seat, then attach the seat to the lower anchors according to the instructions provided by the Child Restraint System manufacturer.
4. Follow the instructions of the Child Restraint System’s manufacturer for proper installation and connection of the lower attachments on the Child Restraint System to the lower anchors.

**⚠ WARNING**

Take the following precautions when using the LATCH system:

- Read and follow all installation instructions provided with your Child Restraint System.
- To prevent the child from reaching and taking hold of unretracted seat belts, buckle all unused rear seat belts and retract the seat belt webbing behind the child. Children can be strangled if a shoulder belt becomes wrapped around their neck and the seat belt tightens.
- **NEVER attach more than one Child Restraint System to a single anchorage. This could cause the anchor or attachment to come loose or break.**
- Always have the LATCH system inspected by your dealer after an accident. An accident can damage the LATCH system and may not properly secure the Child Restraint System.

**NOTICE**

The recommended weight for the LATCH system is under 65 lb. (30 kg).  
 How to determine an appropriate child restraint weight: Child weight + Child restraint weight < 65 lb. (30kg)

**Securing a Child Restraint System seat with "Tether Anchor" system**

First secure the child restraint with the LATCH lower anchors or the seat belt. If the child restraint manufacturer recommends that the top tether strap be attached, attach and tighten the top tether strap to the top tether strap anchor.

Child restraint hook holders are located on the rear of the seatbacks.



To install the tether anchor:

1. Route the Child Restraint System top-tether strap over the seatback. Route the tether strap under the head restraint and between the head restraint posts, or route the tether strap over the top of the vehicle seatback. Make sure the strap is not twisted.
2. Connect the tether strap hook to the tether anchor, then tighten the top-tether strap according to the instructions of your Child Restraint System's manufacturer to firmly attach the Child Restraint System to the seat.
3. Check that the Child Restraint System is securely attached to the seat by pushing and pulling the seat forward-and-back and side-to-side.



### **WARNING**

Take the following precautions when installing the top-tether:

- Read and follow all installation instructions provided with your Child Restraint System.
- **NEVER** attach more than one Child Restraint System to a single tether anchor. This could cause the anchorage or attachment to come loose or break.
- Do not attach the tether strap to anything other than the correct top-tether anchor. It may not work properly if attached to something else.
- Child Restraint System anchors are designed to withstand only those loads imposed by correctly fitted Child Restraint System.

**Under no circumstances are the anchors to be used for adult seat belts or harnesses or for attaching other items or equipment to the vehicle.**



### **Securing a Child Restraint System with a lap/shoulder belt**

#### **WARNING**

**ALWAYS** place a rearward-facing Child Restraint System in the rear seat of the vehicle.

Placing a rearward-facing child restraint in the front seat can result in serious injury or death if the Child Restraint System is struck by an inflating air bag.

When not using the LATCH system, all Child Restraint Systems must be secured to a rear seat with the lap part of a lap/shoulder belt.

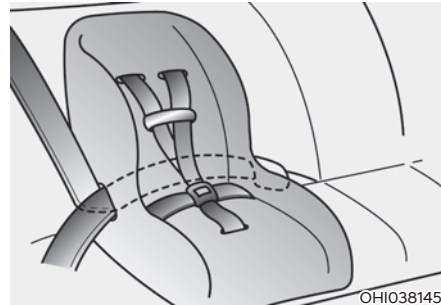

#### **Automatic locking mode**

Since all passenger seat belts move freely under normal conditions and only lock under extreme or emergency conditions (emergency locking mode), you must manually pull the seat belt all the way out to shift the retractor to the "Automatic Locking" mode to secure a Child Restraint System.

The "Automatic Locking" mode will help prevent the normal movement of the child in the vehicle from causing the seat belt to loosen and compromise the Child Restraint System. To secure a Child Restraint System, use the following procedure.

To install a Child Restraint System on the rear seats, do the following:

1. Place the Child Restraint System on a rear seat and route the lap/shoulder belt around or through the Child Restraint System, following the Child Restraint System manufacturer's instructions. Make sure the seat belt webbing is not twisted.

#### **Information**

When using the rear center seat belt, you should also refer to the "Rear Seat Belt – Passenger's 3-point system" section in this chapter.



2. Fasten the lap/shoulder belt latch into the buckle. Listen for the distinct "click" sound.

**i Information**

Position the release button so that it is easy to access in case of an emergency.



3. Pull the shoulder portion of the seat belt all the way out. When the shoulder portion of the seat belt is fully extended, it will shift the retractor to the "Automatic Locking" (child restraint) mode.



4. Slowly allow the shoulder portion of the seat belt to retract and listen for an audible "clicking" or "ratcheting" sound. This indicates that the retractor is in the "Automatic Locking" mode. If no distinct sound is heard, repeat steps 3 and 4.
5. Remove as much slack from the belt as possible by pushing down on the Child Restraint System while feeding the shoulder belt back into the retractor.
6. Push and pull on the Child Restraint System to confirm that the seat belt is holding it firmly in place. If it is not, release the seat belt and repeat steps 2 through 6.
7. Double check that the retractor is in the "Automatic Locking" mode by attempting to pull more of the seat belt out of the retractor. If you cannot, the retractor is in the "Automatic Locking" mode.

If your Child Restraint System manufacturer instructs or recommends you to use a tether anchor with the lap/shoulder belt, refer to the previous pages for more information.

 **Information**

When the seat belt is allowed to retract to its fully stowed position, the retractor will automatically switch from the “Automatic Locking” mode to the emergency lock mode for normal adult usage.

 **WARNING**

If the retractor is not in the “Automatic Locking” mode, the child restraint can move when your vehicle turns or stops suddenly. A child can be seriously injured or killed if the child restraint is not properly anchored in the car, including manually pulling the seat belt all the way out to shift the retractor to the “Automatic Locking” mode.

To remove the Child Restraint System, press the release button on the buckle and then pull the lap/shoulder belt out of the Child Restraint System and allow the seat belt to retract fully.

 **WARNING**

If a child restraint is installed in the second row center seat, move the second row seat far back as possible, to minimize contact with the front center air bag.

## AIR BAG - SUPPLEMENTAL RESTRAINT SYSTEM

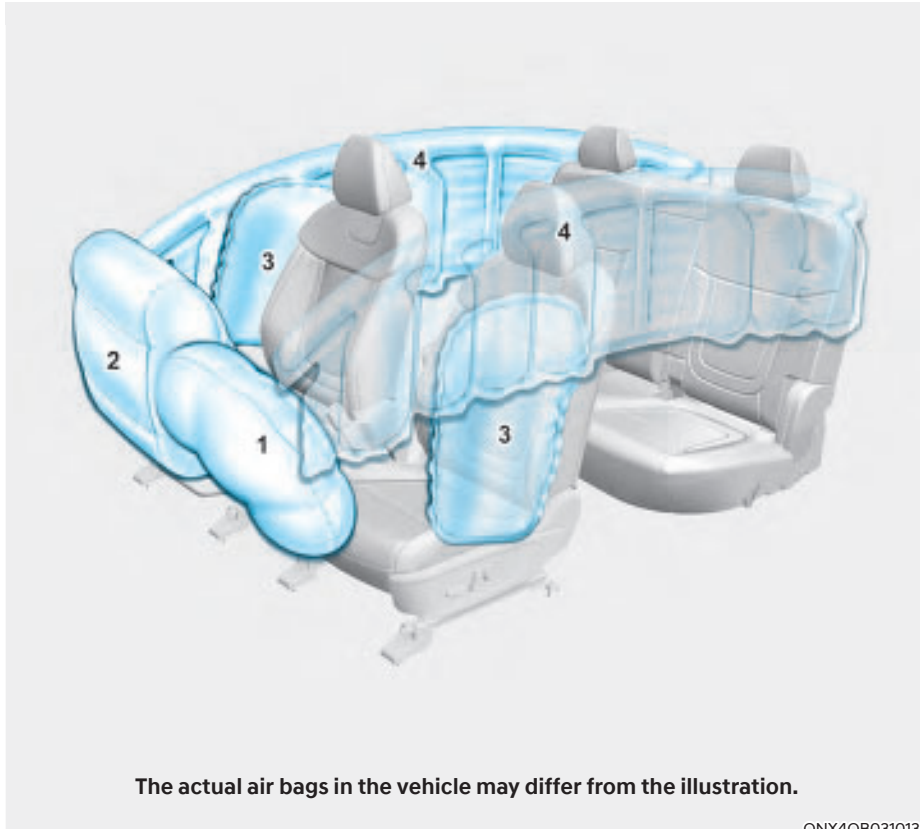

1. Driver's front air bag
2. Passenger's front air bag
3. Side air bag
4. Curtain air bag

This vehicle is equipped with a Supplemental Air Bag System for the driver's seat and front passenger's seats.

The front air bags are designed to supplement the three-point seat belts. For these air bags to provide protection, the seat belts must be worn at all times when driving.

You can be severely injured or killed in an accident if you are not wearing a seat belt. Air bags are designed to supplement seat belts, but do not replace them. Also, air bags are not designed to deploy in every collision. In some accidents, the seat belts are the only restraint protecting you.



## **WARNING**

### **AIR BAG SAFETY PRECAUTIONS**

**ALWAYS** use seat belts Child Restraint Systems - every trip, every time, everyone! Even with air bags, you can be seriously injured or killed in a collision if you are improperly belted or not wearing your seat belt when the air bag inflates.

**NEVER** place a child in any Child Restraint System or booster seat in the front passenger seat, unless the air bag is deactivated.

An inflating air bag could forcefully strike the infant or child causing serious or fatal injuries.

**ABC - Always Buckle Children** under age 13 in the back seat. It is the safest place for children of any age to ride. If a child age 13 or older must be seated in the front seat, he or she must be properly belted and the seat should be moved as far back as possible.

All occupants should sit upright with the seatback in an upright position, centered on the seat cushion with their seat belt on, legs comfortably extended and their feet on the floor until the vehicle is parked and the vehicle is turned off. If an occupant is out of position during an accident, the rapidly deploying air bag may forcefully contact the occupant causing serious or fatal injuries.

You and your passengers should never sit or lean unnecessarily close to the air bags or lean against the door or center console.

Move your seat as far back as possible from front air bags, while still maintaining control of the vehicle. The U.S. National Highway Traffic Safety Administration (NHTSA) recommends that drivers allow at least 10 inches (25 cm) between the center of the steering wheel and the chest.

## Where are the Air Bags?

### Driver's and passenger's front air bags



Your vehicle is equipped with a Supplemental Restraint System (SRS) as well as lap/shoulder belts at both the driver and passenger seating positions.

The SRS consists of air bags which are located in the center of the steering wheel and the passenger's side front panel pad above the glove box.

The air bags are labeled with the letters "AIR BAG" embossed on the pad covers.

The purpose of the SRS is to provide the vehicle's driver and front passengers with additional protection than that offered by the seat belt system alone in case of a frontal impact of sufficient severity.

The SRS uses sensors to gather information about the driver's and front passenger's seat belt usage and impact severity.

The seat belt buckle sensors determine if the driver and front passenger's seat belts are fastened. These sensors provide the ability to control the SRS deployment based on whether or not the seat belts are fastened, and how severe the impact is.

The advanced SRS offers the ability to control the air bag inflation within two levels. A first stage level is provided for moderate-severity impacts. A second stage level is provided for more severe impacts.

According to the impact severity, and seat belt usage, the SRS Control Module (SRSCM) controls the air bag inflation. Failure to properly wear seat belts can increase the risk or severity of injury in an accident.

### WARNING

To reduce the risk of serious injury or death from inflating front air bags, take the following precautions:

- **Seat belts must be worn at all times to help keep occupants positioned properly.**
- **Move your seat as far back as possible from front air bags, while still maintaining control of the vehicle.**
- **Never lean against the door or center console.**
- **Do not allow the front passenger to place their feet or legs on the dashboard.**
- **No objects (such as crash pad cover, mobile phone holder, cup holder, air fresheners or stickers) should be placed over or near the air bag modules on the steering wheel, instrument panel, windshield glass, and the front passenger's panel above the glove box. Such objects could cause harm if the vehicle is in a crash severe enough to cause the air bags to deploy.**
- **Do not attach any objects on the front windshield and inside mirror.**

### Side air bags

■ Side air bag

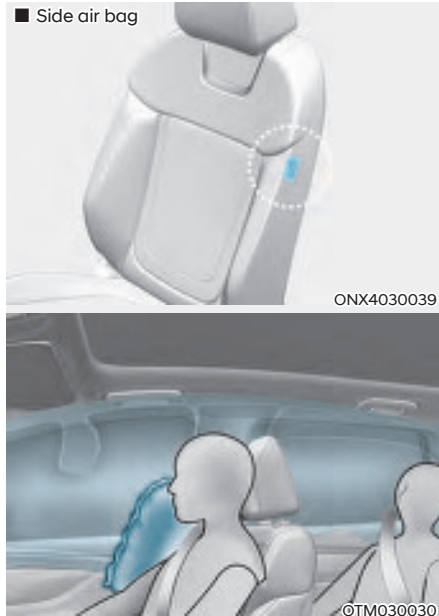

Your vehicle is equipped with a side air bag in each front seat. The purpose of the air bag is to provide the vehicle's driver and the front passenger with additional protection than that offered by the seat belt alone.

The side air bags are designed to deploy during certain side impact collisions, depending on the crash severity.

The side air bags on both sides of the vehicle are designed to deploy when a rollover is detected by a rollover sensor. (if equipped with rollover sensor)

The side air bags are not designed to deploy in all side impact or rollover situations.

### WARNING

To reduce the risk of serious injury or death from an inflating side air bag and front center air bag, take the following precautions:

- Seat belts must be worn at all times to help keep occupants positioned properly.
- Do not allow passengers to lean their heads or bodies onto doors, put their arms on the doors, stretch their arms out of the window, or place objects between the doors and seats.
- Hold the steering wheel at the 9 o'clock and 3 o'clock positions, to minimize the risk of injuries to your hands and arms.
- Do not use any accessory seat covers. This could reduce or prevent the effectiveness of the system.
- Do not hang other objects except clothes. In an accident it may cause vehicle damage or personal injury especially when air bag is inflated.
- Do not place any objects over the air bag or between the air bag and yourself. Also, do not attach any objects around the area the air bag inflates such as the door, side door glass, front and rear pillar.
- Do not place any objects between the door and the seat. They may become dangerous projectiles if the side air bag inflates.
- Do not install any accessories on the side or near the side air bags.
- Do not cause impact to the doors when the ignition switch button is in the ON or START position as this may cause the side air bags to inflate.
- If the seat or seat cover is damaged, have the system be serviced by an authorized HYUNDAI dealer.

### Curtain air bags

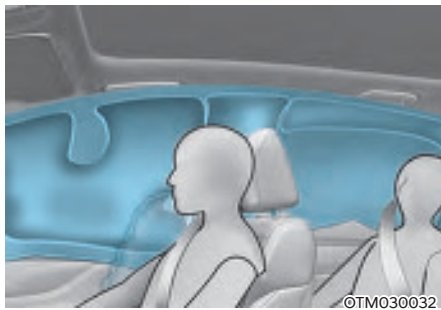

Curtain air bags are located along both sides of the roof rails above the front and rear doors.

They are designed to help protect the heads of the front seat occupants and the rear outboard seat occupants in certain side impact collisions.

The curtain air bags are designed to deploy during certain side impact collisions, depending on the crash severity.

For vehicles equipped with a rollover sensor the side and/or curtain air bags and pre-tensioners on both sides of the vehicle may deploy if a rollover or possible rollover is detected.

The curtain air bags are not designed to deploy in all side impact or rollover situations.

### **WARNING**

To reduce the risk of serious injury or death from an inflating curtain air bag, take the following precautions:

- All seat occupants must wear seat belts at all times to help keep occupants positioned properly.
- Properly secure Child Restraint System as far away from the door as possible.
- Do not place any objects over the air bag. Also, do not attach any objects around the area the air bag inflates such as the door, side door glass, front and rear pillar, roof side rail.
- Do not hang other objects except clothes, especially hard or breakable objects.  
In an accident, it may cause vehicle damage or personal injury.
- Do not allow passengers to lean their heads or bodies onto doors, put their arms on the doors, stretch their arms out of the window, or place objects between the doors and seats.
- Do not open or repair the side curtain air bags.



## How does the SRS Air Bag System Operate?

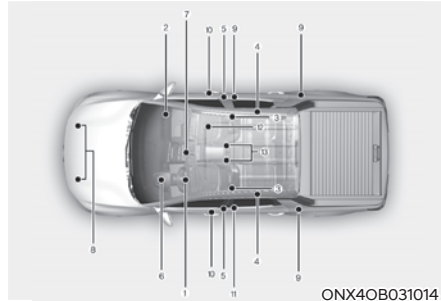

The SRS consists of the following components:

- (1) Driver's front air bag module
- (2) Passenger's front air bag module
- (3) Side air bag modules
- (4) Curtain air bag modules
- (5) Retractor pre-tensioner
- (6) Air bag warning light
- (7) SRS control module (SRSCM)/ Rollover sensor
- (8) Front impact sensors
- (9) Side impact sensors
- (10) Side pressure sensors
- (11) Emergency fastening device system
- (12) Occupant classification system
- (13) Seat belt buckle sensor

The SRSCM continually monitors all SRS components while the ignition switch is ON to determine if a crash impact is severe enough to require air bag deployment or pre-tensioner seat belt deployment.



### SRS warning light

The SRS (Supplemental Restraint System) air bag warning light on the instrument panel displays the air bag symbol depicted in the illustration. The system checks the air bag electrical system for malfunctions. The light indicates that there is a potential problem with your air bag system, which could include your side and/or curtain air bags used for rollover protection (if equipped with rollover sensor).



### WARNING

**If your SRS malfunctions, the air bag may not inflate properly during an accident increasing the risk of serious injury or death.**

**If any of the following conditions occur, your SRS is malfunctioning:**

- **The light does not turn on for approximately three to six seconds when the Engine Start/Stop button is in the ON position.**
- **The light stays on after illuminating for approximately three to six seconds.**
- **The light comes on while the vehicle is in motion.**
- **The light blinks when the engine is running.**

**Have an authorized HYUNDAI dealer inspect the SRS as soon as possible if any of these conditions occur.**

During a moderate to severe frontal collision, sensors will detect the vehicle's rapid deceleration. If the rate of deceleration is high enough, the control unit will inflate the front air bags, at the time and with the force needed.

The front air bags help protect the driver and front passenger by responding to frontal impacts in which seat belts alone cannot provide adequate restraint. When needed, the side air bags help provide protection in the event of a side impact or rollover by supporting the side upper body area.

- Air bags are activated (able to inflate if necessary) only when the Engine Start/Stop button is in the ON or START position, and it can be activated within about 3 minutes after the engine is turned off.
- Air bags inflate in the event of certain frontal or side collisions to help protect the occupants from serious physical injury.
- There is no single speed at which the air bags will inflate. Generally, air bags are designed to inflate based upon the severity of a collision and its direction. These two factors determine whether the sensors produce an electronic deployment/inflation signal.
- The front air bags will completely inflate and deflate in an instant. It is virtually impossible for you to see the air bags inflate during an accident. It is much more likely that you will simply see the deflated air bags hanging out of their storage compartments after the collision.

- In addition to inflating in serious side collisions, vehicles equipped with a rollover sensor, side and/or curtain air bags will inflate if the sensing system detects a rollover.

When a rollover is detected, curtain air bags will remain inflated longer to help provide protection from ejection, especially when used in conjunction with the seat belts. (if equipped with a rollover sensor)

- To help provide protection, the air bags must inflate rapidly. The speed of air bag inflation is a consequence of extremely short time in which to inflate the air bag between the occupant and the vehicle structures before the occupant impacts those structures. This speed of inflation reduces the risk of serious or lifethreatening injuries and is thus a necessary part of air bag design. However, the rapid air bag inflation can also cause injuries which can include facial abrasions, bruises and broken bones because the inflation speed also causes the air bags to expand with a great deal of force.
- There are even circumstances under which contact with the air bag can cause fatal injuries, especially if the occupant is positioned excessively close to the air bag.

You can take steps to reduce the risk of being injured by an inflating air bag. The greatest risk is sitting too close to the air bag. An air bag needs about 10 in. (25 cm) of space to inflate. NHTSA recommends that drivers allow at least 10 in. (25 cm) between the center of the steering wheel and the chest.

 **WARNING**

To reduce the risk of serious injury or death from an inflating air bag, take the following precautions:

- **NEVER** place a child restraint in the front passenger seat.  
Always properly restrain children under age 13 in the rear seats of the vehicle.
- **Adjust the front passenger's and driver's seats as far to the rear as possible while allowing you to maintain full control of the vehicle.**
- **Hold the steering wheel with hands at the 9 o'clock and 3 o'clock positions.**
- **Never place anything or anyone between the air bag and the seat occupant.**
- **Do not allow the front passenger to place their feet or legs on the dashboard.**

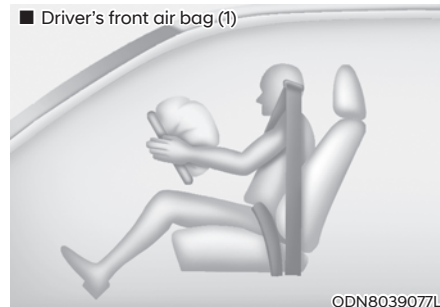

When the SRSCM detects a sufficiently severe impact to the front of the vehicle, it will automatically deploy the front air bags.

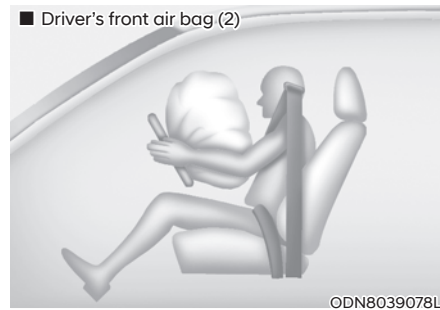

Upon deployment, tear seam molded directly into the pad cover will separate under pressure from the expansion of the air bags. Further opening of the covers allows full inflation of the air bags.

A fully inflated air bag, in combination with a properly worn seat belt, slows the driver's or the front passenger's forward motion, reducing the risk of head and chest injury.

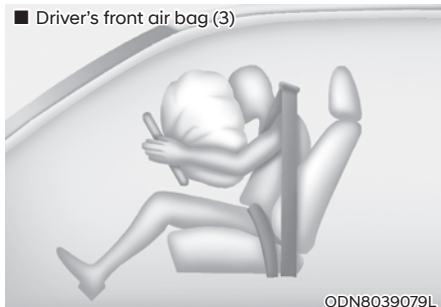

After complete inflation, the air bag immediately starts deflating, enabling the driver to maintain forward visibility and the ability to steer or operate other controls.

### **WARNING**

To prevent objects from becoming dangerous projectiles when the passenger's air bag inflates:

- Do not install or place any objects (drink holder, CD holder, stickers, etc.) on the front passenger's panel above the glove box where the passenger's air bag is located.
- Do not install a container of liquid air freshener near the instrument cluster or on the instrument panel surface.

### **What to expect after an air bag inflates**

After a frontal or side air bag inflates, it will deflate very quickly. Air bag inflation will not prevent the driver from seeing out of the windshield or being able to steer as it will immediately start deflating. Curtain air bags may remain partially inflated for some time after they deploy.

### **WARNING**

After an air bag inflates, take the following precautions:

- Open your windows and doors as soon as possible after impact to reduce prolonged exposure to the smoke and powder released by the inflating air bag.
- Do not touch the air bag storage area's internal components immediately after an air bag has inflated. The parts that come into contact with an inflating air bag may be very hot.
- Always wash exposed skin areas thoroughly with cold water and mild soap.
- Always have an authorized HYUNDAI dealer replace the air bag immediately after deployment. Air bags are designed to be used only once.

### ***Noise and smoke from inflating air bag***

When the air bags inflate, they make a loud noise and may produce smoke and powder in the air inside of the vehicle. This is normal and is a result of the ignition of the air bag inflator. After the air bag inflates, you may feel substantial discomfort in breathing because of the contact of your chest with both the seat belt and the air bag, as well as from breathing the smoke and powder. The powder may aggravate asthma for some people. If you experience breathing problems after an air bag deployment, seek medical attention immediately.

Though the smoke and powder are nontoxic, they may cause irritation to the skin, eyes, nose, throat, etc. If this is the case, wash and rinse with cold water immediately and seek medical attention if the symptoms persist.

### **Occupant Classification System (OCS)**



Your vehicle is equipped with an Occupant Classification System (OCS) in the front passenger's seat.

### **Main components of the Occupant Classification System**

- A detection device located within the front passenger seat cushion.
- Electronic system to help determine whether the passenger air bag systems should be activated or deactivated.
- An indicator light located on the instrument panel which illuminates the words “PASSENGER AIR BAG OFF” indicating the front passenger air bag system is deactivated.
- The instrument panel air bag indicator light is interconnected with the OCS.

The OCS is designed to help detect the presence of a properly-seated front passenger and determine if the passenger’s front air bag should be enabled (may inflate) or not.

The purpose is to help reduce the risk of injury or death from an inflating air bag to certain front passenger seat occupants, such as children, by requiring the air bag to be automatically turned OFF.

For example, if a child restraint of the type specified in the regulations is on the seat, the occupant classification sensor can detect it and cause the air bag to turn OFF.

Front passenger seat adult occupants who are properly seated and wearing the seat belt properly, should not cause the passenger air bag to be automatically turned OFF. For smaller adults it may turn OFF, however, if the occupant does not sit in the seat properly (for example, by not sitting upright, by sitting on the edge of the seat, or by otherwise being out of position), this could cause the sensor to turn the air bag OFF.

You will find the “PASSENGER AIR BAG OFF” indicator on the overhead console panel. This system detects the conditions 1-4 in the following table and activates or deactivates the front passenger air bag based on these conditions.

Always be sure that you and all vehicle occupants are seated properly and wearing the seat belt properly for the most effective protection by the air bag and the seat belt.

The OCS may not function properly if the passenger takes actions which can affect the classification system. These include:

- Failing to sit in an upright position.
- Leaning against the door or center console.
- Sitting towards the sides of the front of the seat.
- Putting their legs on the dashboard or resting them on other locations which reduce the passenger weight on the front seat.
- Wearing the seat belt improperly.
- Reclining the seatback.
- Wearing thick clothes like ski wear or hip protection wear.
- Putting an additional thick cushion on the seat.
- Putting electrical devices (for example, notebook, satellite radio) on the seat with inverter charging.

### Condition and operation in the front passenger Occupant Classification System

Condition detected by the occupant classification system	Indicator/Warning light		Devices
	"PASSENGER AIR BAG OFF" indicator light	SRS warning light	Front passenger air bag
1. Adult*1	Off	Off	Activated
2. Infant*2 or child restraint system with 12 months old *3 *4	On	Off	Deactivated
3. Unoccupied	On	Off	Deactivated
4. Malfunction in the system	Off	On	Activated

\*1: The system judges a person of adult size as an adult. When a smaller adult sits in the front passenger seat, the system may recognize him/her as a child depending on his/her physique and posture.

\*2: Do not allow children to ride in the front passenger seat. When a larger child who has outgrown a child restraint system sits in the front passenger seat, the system may recognize him/her as an adult depending upon his/her physique or sitting position.

\*3: Never install a child restraint system on the front passenger seat.

\*4: The PASSENGER AIR BAG "OFF" indicator may turn on or off when a child above 12 months to 12 years old (with or without child restraint system) sits in the front passenger seat. This is a normal condition.

 **WARNING**

Riding in an improper position or placing weight on the front passenger's seat when it is unoccupied by a passenger adversely affects the OCS. To reduce the risk of serious injury or death:



- **NEVER** put a heavy load in the front seat or seatback pocket, or hang any items on the front passenger seat.



- **NEVER** place your feet on the front passenger seatback.



- **NEVER** sit with your hips shifted towards the front of the seat.



- **NEVER** ride with the seatback reclined when the vehicle is moving.



- **NEVER** place your feet or legs on the dashboard.





- **NEVER** lean on the door or center console or sit on one side of the front passenger seat.



- Do not sit on the passenger seat wearing heavily padded clothes such as ski wear and hip protector.



- Do not use car seat accessories such as thick blankets and cushions which cover up the car seat surface.



- Do not place electronic devices such as laptops, DVD player, or conductive materials such as water bottles on the passenger seat.
- Do not use electronic devices such as laptops and satellite radios which use inverter chargers.



- If large quantity of liquid has been spilled on the passenger seat, the air bag warning light may illuminate or malfunction. Therefore, make sure the seat has been completely dried before driving the vehicle.

- Do not place sharp objects on the front passenger seat. These may damage the occupant detection system, if they puncture the seat cushion.
- Do not place any items under the front passenger seat.
- When changing or replacing the seat or seat cover, use original items only. The OCS has been developed based on using original HYUNDAI car seats only. Altering or changing the authentic parts may result in system malfunction and increase risk of injury when in collision. Any of the above could interfere with the proper operation of the OCS sensor thereby increasing the risk of an injury in an accident.

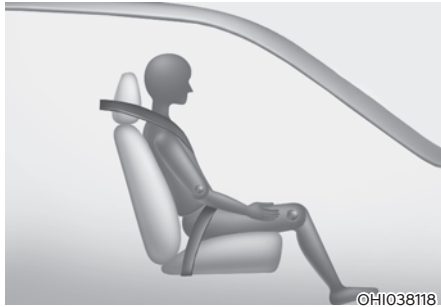

**Proper seated position for OCS**

If the “PASSENGER AIR BAG OFF” indicator is on when an adult is seated in the front passenger seat, place the Ignition switch in the OFF position and ask the passenger to sit properly (sitting upright with the seat back in an upright position, centered on the seat cushion with their seat belt on, legs comfortably extended and their feet on the floor). Restart the engine and have the person remain in that position. This will allow the system to detect the person and to enable the passenger air bag. If the “PASSENGER AIR BAG OFF” indicator is still on, ask the passenger to move to the rear seat.

 **WARNING**

**NEVER** allow an adult passenger to ride in the front passenger seat when the “PASSENGER AIR BAG OFF” indicator is illuminated. During a collision, the air bag will not inflate if the indicator is illuminated. Have your passenger reposition themselves in the seat. If the “PASSENGER AIR BAG OFF” indicator remains illuminated after the passenger repositions themselves properly and the vehicle is restarted, have the passenger move to the rear seat because the air bag will not inflate.

**NOTICE**

The “PASSENGER AIR BAG OFF” indicator generally illuminates for approximately 4 seconds after the Engine Start/Stop button is in the ON or START position. But, if the Engine START/STOP button is pressed to the ON or START position within 3 minutes after the engine is turned OFF, the indicator does not illuminate. If the front passenger seat is occupied, the OCS will then classify the front passenger after several more seconds.

**Do not install a Child Restraint System on the Front Passenger's Seat**



Even though your vehicle is equipped with the OCS, never install a child restraint in the front passenger's seat. An inflating air bag can forcefully strike a child or child restraint resulting in serious or fatal injury.



**WARNING**

**NEVER** use a rearward facing Child Restraint on a seat protected by an **ACTIVE AIRBAG** in front of it, **DEATH** or **SERIOUS INJURY** to the **CHILD** can occur.

**Why didn't my air bag go off in a collision?**

There are certain types of accidents in which the air bag would not be expected to provide additional protection. These include rear impacts, second or third collisions in multiple impact accidents, as well as low speed impacts. Damage to the vehicle indicates a collision energy absorption, and is not an indicator of whether or not an air bag should have inflated.

**Air bag collision sensors**



**WARNING**

**To reduce the risk of an air bag deploying unexpectedly and causing serious injury or death:**

- Do not hit or allow any objects to impact the locations where air bags or sensors are installed.
- Do not perform maintenance on or around the air bag sensors. If the location or angle of the sensors is altered, the air bags may deploy when they should not or may not deploy when they should.
- Installing bumper guards with non-genuine Hyundai or non-equivalent parts may adversely affect the collision and airbag deployment performance.
- Place the ignition switch in the **LOCK/OFF** or **ACC** position and wait for 3 minutes when the vehicle is being towed to prevent inadvertent air bag deployment.
- Have all air bag repairs are conducted by an authorized **HYUNDAI** dealer.

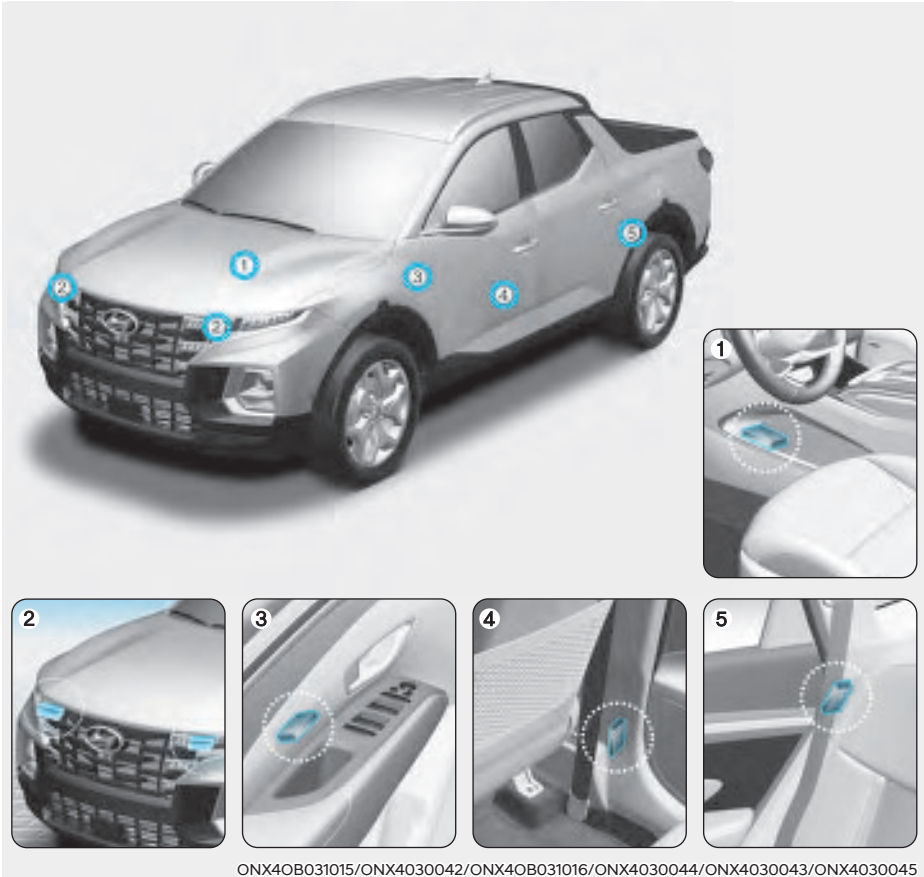

ONX4OB031015/ONX4030042/ONX4OB031016/ONX4030044/ONX4030043/ONX4030045

- 1. SRS control module / Rollover sensor
- 2. Front impact sensor
- 3. Side impact sensor (Pressure)
- 4. Side impact sensor (Acceleration)
- 5. Side impact sensor (Acceleration)

### Air bag inflation conditions



#### Front air bags

Front air bags are designed to inflate in a frontal collision depending on the severity of impact of the front collision.



#### Side and curtain air bags

Side and curtain air bags are designed to inflate when an impact is detected by side collision sensors depending on the severity, from a side impact collision.

Although the driver's and front passenger's air bags are designed to inflate in frontal collisions, they also may inflate in other types of collisions if the front impact sensors detect a sufficient impact. Side and curtain air bags are designed to inflate in side impact collisions, but they may inflate in other collisions if the side impact sensors detect a sufficient impact.

Also, the side and curtain air bags are designed to inflate when a rollover is detected by a rollover sensor. (if equipped with rollover sensor)

If the vehicle chassis is impacted by bumps or objects on unimproved roads, the air bags may deploy. Drive carefully on unimproved roads or on surfaces not designed for vehicle traffic to prevent unintended air bag deployment.

**Air bag non-inflation conditions**



In certain low-speed collisions the air bags may not deploy. The air bags are designed not to deploy in such cases because they may not provide benefits beyond the protection of the seat belts.



Front air bags are not designed to inflate in rear collisions, because occupants are moved backward by the force of the impact. In this case, inflated air bags would not provide any additional benefit.



Front air bags may not inflate in side impact collisions, because occupants move in the direction of the collision, and thus in side impacts, front air bag deployment would not provide additional occupant protection.

However, side and curtain air bags and front center air bag may inflate depending on the severity of impact.



In an angled collision, the force of impact may direct the occupants in a direction where the air bags would not be able to provide any additional benefit, and thus the sensors may not deploy any air bags.

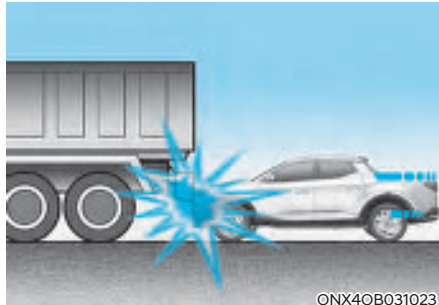

Just before impact, drivers often brake heavily. Such heavy braking lowers the front portion of the vehicle causing it to “ride” under a vehicle with a higher ground clearance. Air bags may not inflate in this “underride” situation because deceleration forces that are detected by sensors may be significantly reduced by such “underride” collisions.



Air bags may not inflate if the vehicle collides with objects such as utility poles or trees, where the point of impact is concentrated and the collision energy is absorbed by the vehicle structure.



Front air bags may not inflate in rollover accidents because front air bag deployment would not provide additional occupant protection.

However, the side and curtain air bags and front center air bag may inflate in a rollover situation, when it is detected by the rollover sensor.

### SRS Care

The SRS is virtually maintenance-free and there are no parts you can safely service by yourself. If the SRS air bag warning light does not illuminate when the ignition switch is in the ON position, or continuously remains on, have your vehicle immediately inspected by an authorized HYUNDAI dealer. Any work on the SRS system, such as removing, installing, repairing, or any work on the steering wheel, the front passenger's panel, front seats and roof rails must be performed by an authorized HYUNDAI dealer. Improper handling of the SRS system may result in serious personal injury.



### WARNING

To reduce the risk of serious injury or death take the following precautions:

- Do not attempt to modify or disconnect the SRS components or wiring, including the addition of any kind of badges to the pad covers or modifications to the body structure.
- Do not place objects over or near the air bag modules on the steering wheel, instrument panel, and the front passenger's panel above the glove box.
- Clean the air bag pad covers with a soft cloth moistened with plain water. Solvents or cleaners could adversely affect the air bag covers and proper deployment of the system.
- Always have inflated air bags replaced by an authorized HYUNDAI dealer.
- If components of the air bag system must be discarded, or if the vehicle must be scrapped, certain safety precautions must be observed. Consult an authorized HYUNDAI dealer for the necessary information. Failure to follow these precautions could increase the risk of personal injury.



### Additional Safety Precautions

**Passengers should not move out of or change seats while the vehicle is moving.** A passenger who is not wearing a seat belt during a crash or emergency stop can be thrown against the inside of the vehicle, against other occupants, or be ejected from the vehicle.

**Do not use any accessories on seat belts.** Devices claiming to improve occupant comfort or reposition the seat belt can reduce the protection provided by the seat belt and increase the chance of serious injury in a crash.

**Do not modify the front seats.** Modification of the front seats could interfere with the operation of the supplemental restraint system sensing components or side air bags.

**Do not place items under the front seats.** Placing items under the front seats could interfere with the operation of the supplemental restraint system sensing components and wiring harnesses.

**Do not cause impact to the doors.** Impact to the doors when the Engine Start/Stop button is in the ON or START position may cause the air bags to inflate.

**Modifications to accommodate disabilities.** If you require modification to your vehicle to accommodate a disability, contact the HYUNDAI Customer Connect Center at 800-633-5151.

### ***Adding equipment to or modifying your air bag equipped vehicle***

If you modify your vehicle by changing your vehicle's frame, bumper system, front end or side sheet metal or ride height, this may affect the operation of your vehicle's air bag system.

### Air Bag Warning Labels

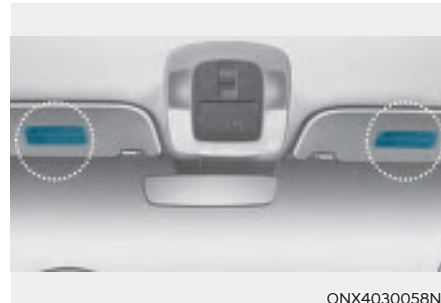

Air bag warning labels, required by the U.S. National Highway Traffic Safety Administration (NHTSA), are attached to alert the driver and passengers of potential risks of the air bag system. Be sure to read all of the information about the air bags that are installed on your vehicle in this Owners Manual.



# 4. Instrument Cluster

- Instrument Cluster ..... 4-4
- Instrument Cluster Control..... 4-5
  - Instrument panel illumination..... 4-5
- Gauges and Meters ..... 4-5
  - Speedometer ..... 4-5
  - Tachometer ..... 4-5
  - Engine coolant temperature gauge..... 4-6
  - Fuel gauge..... 4-6
  - Outside temperature gauge..... 4-7
  - Odometer ..... 4-7
  - Distance to empty ..... 4-8
  - Fuel economy (for 10.25-inch cluster) ..... 4-8
- Transmission Shift Indicator ..... 4-9
- Warning and Indicator Lights ..... 4-9
  - Seat belt warning light ..... 4-9
  - Air bag warning light ..... 4-9
  - Parking brake warning light ..... 4-10
  - Anti-lock Brake System (ABS) warning light ..... 4-11
  - Electronic Brake Force Distribution (EBD) system warning light ..... 4-11
  - Electric Power Steering (EPS) warning light ..... 4-12
  - Charging system warning light ..... 4-12
  - Engine oil pressure warning light ..... 4-12
  - Low fuel level warning light ..... 4-13
  - Malfunction Indicator Lamp (MIL)..... 4-13
  - Electronic Parking Brake (EPB) warning light ..... 4-14
  - AUTO HOLD indicator light ..... 4-15
  - Low tire pressure warning light ..... 4-15
  - Forward Safety warning light ..... 4-16
  - Lane Safety indicator light ..... 4-16
  - 4 Wheel Drive (AWD) warning light ..... 4-16
  - 4 Wheel Drive (AWD) LOCK Indicator Light ..... 4-17
  - LED headlight warning light..... 4-17
  - Icy road warning light ..... 4-18
  - Electronic Stability Control (ESC) indicator light..... 4-18
  - Electronic Stability Control (ESC) OFF indicator light..... 4-18
  - Immobilizer Indicator Light (without smart key) ..... 4-19
  - Immobilizer Indicator Light (with smart key) ..... 4-19
  - Downhill Brake Control (DBC) indicator light ..... 4-20
  - Turn signal indicator light..... 4-20
  - High beam indicator light ..... 4-20



4

High Beam Assist indicator light.....4-21  
Cruise Indicator Light.....4-21  
Master warning light.....4-21  
LCD Display Messages for Vehicles Equipped with Smart Key..... 4-22  
Shift to P ..... 4-22  
Low key battery.....4-22  
Press START button while turning wheel .....4-22  
Check steering wheel lock system .....4-22  
Press brake pedal to start engine .....4-22  
Key not in vehicle .....4-22  
Key not detected.....4-22  
Press START button again .....4-22  
Press START button with key .....4-23  
Check BRAKE SWITCH fuse .....4-23  
Shift to P or N to start engine .....4-23  
Battery discharging due to external electrical devices.....4-23  
Door, Hood, Tailgate open indicator .....4-24  
Sunroof open indicator.....4-24  
Low tire pressure .....4-24  
Lights .....4-25  
Wiper .....4-25  
Low washer fluid.....4-25  
Low fuel .....4-25  
Low engine oil .....4-25  
Engine overheated .....4-26  
Check headlight.....4-26  
Check turn signal .....4-26  
Check headlamp LED .....4-26

# 4. Instrument Cluster

---

LCD Display .....	4-27
LCD Display Control .....	4-27
View Modes .....	4-28
Trip computer mode .....	4-29
Turn By Turn (TBT) mode .....	4-29
Driving Assist mode .....	4-29
Master warning group .....	4-30
User Settings Mode .....	4-31
Trip Computer (Type A : 4.2" LCD) .....	4-38
Trip modes .....	4-38
Trip Computer (Type B : 10.25" LCD) .....	4-40
Trip modes .....	4-40
Infotainment System Vehicle Settings .....	4-42
Setting Your Vehicle .....	4-42

## INSTRUMENT CLUSTER

■ 4.2-inch



■ 10.25-inch

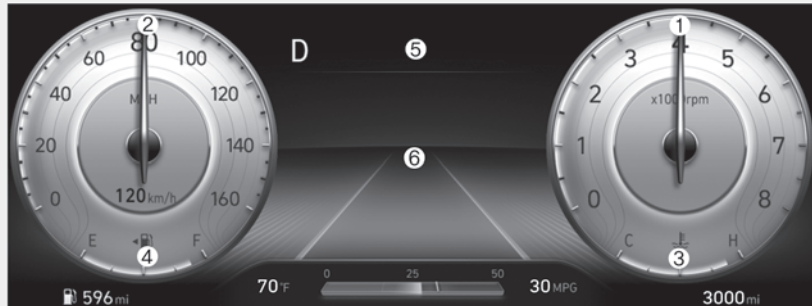

The actual cluster in the vehicle may differ from the illustration.  
For more information, refer to “Gauges and meters” section in this chapter.

ONX4OB041001/OCN7040080N

- |                                     |                                 |
|-------------------------------------|---------------------------------|
| 1. Tachometer                       | 4. Fuel gauge                   |
| 2. Speedometer                      | 5. Warning and indicator lights |
| 3. Engine coolant temperature gauge | 6. LCD display                  |

## Instrument Cluster Control

### *Instrument panel illumination*

When the vehicle's parking lights or headlamps are on, press the illumination control switch to adjust the brightness of the instrument panel illumination.

When pressing the illumination control switch, the interior switch illumination intensity also adjusted.

You can adjust the brightness of the instrument panel illumination from the User Settings Mode on the LCD display when the ignition switch is on ('Lights → Illumination'). When the vehicle's parking lights or headlamps are on, interior switch illumination intensity and mood lamps are also adjusted.

**If your vehicle is equipped with additional navigation, please refer to the infotainment system manual separately supplied.**

### **WARNING**

**Never adjust the instrument cluster while driving. This could result in loss of control and lead to an accident that may cause vehicle damage, or lead to serious injury or death.**

- The brightness of the instrument panel illumination is displayed.
- When the brightness setting reaches either the minimum or maximum level, a chime will sound.

## Gauges and Meters

### *Speedometer*

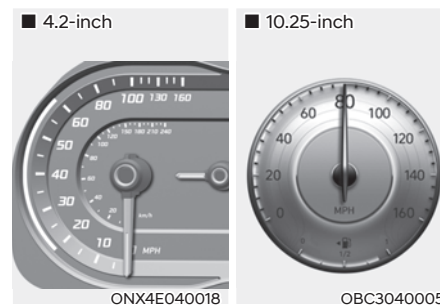

The speedometer indicates the speed of the vehicle and is calibrated in miles per hour (MPH) and/or kilometers per hour (km/h).

### *Tachometer*

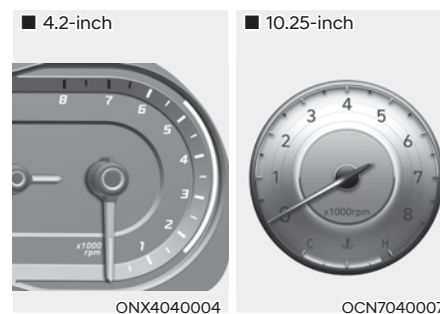

The tachometer indicates the approximate number of engine revolutions per minute (RPM).

Use the tachometer to select the correct shift points and to prevent lugging and/or over-revving the engine.

### **NOTICE**

**Do not operate the engine within the tachometer's RED ZONE. This may cause severe engine damage.**

### Engine coolant temperature gauge

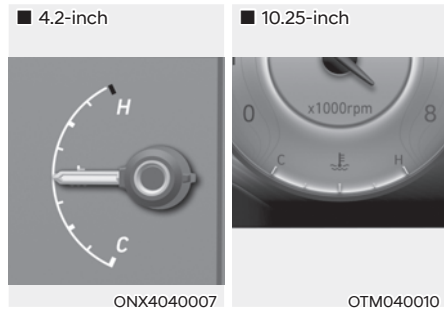

This gauge indicates the temperature of the engine coolant when the ignition switch is in the ON position.

#### NOTICE

If the gauge pointer moves beyond the normal range area toward the H (or HOT) position, it indicates overheating that may damage the engine.

Do not continue driving with an overheated engine. If your vehicle overheats, refer to “If the Engine Overheats” section in chapter 8.

#### WARNING

Never remove the engine coolant reservoir cap when the engine is hot. The engine coolant is under pressure and could cause a severe burn or injury. Wait until the engine is cool before adding coolant to the reservoir.

### Fuel gauge

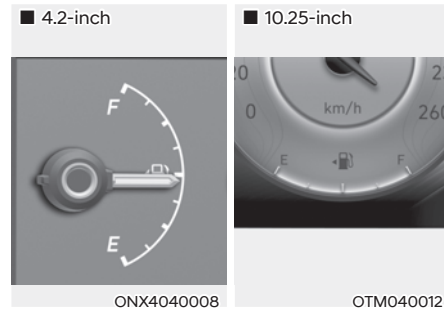

This gauge indicates the approximate amount of fuel remaining in the fuel tank.

#### Information

- The fuel tank capacity is given in chapter 2.
- The fuel gauge is supplemented by a low fuel warning light, which will illuminate when the fuel tank is nearly empty.
- On inclines or curves, the fuel gauge pointer may fluctuate or the low fuel warning light may come on earlier than usual due to the movement of fuel in the tank.

#### WARNING

Running out of fuel can expose vehicle occupants to danger.

You must stop and obtain additional fuel as soon as possible after the warning light comes on or when the gauge indicator comes close to the “E (Empty) or 0” level.

#### NOTICE

Avoid driving with an extremely low fuel level. Running out of fuel could cause the engine to misfire damaging the catalytic converter.



### Outside temperature gauge

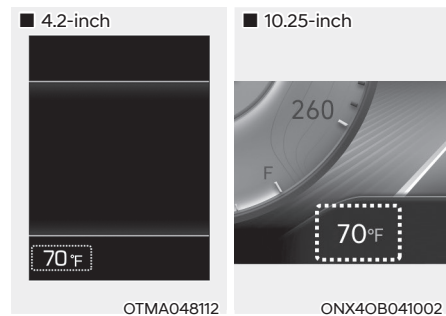

The outside ambient temperature is displayed in the lower portion of the LCD cluster display. The temperature will read in Fahrenheit or Celsius depending on the units selected in the User Settings menu.

Note that the temperature indicated on the LCD display may not change as quickly as the outside temperature (there may be a slight delay before the temperature changes.)

You can change the temperature unit from the Settings menu in the cluster or infotainment system screen.

Select:

- Setup → Unit → Temperature Unit → °F/°C (for cluster type)
- Setup → General Settings → Unit → Temperature Unit → °C/°F (for infotainment system screen type)

Both the temperature unit on the cluster LCD display and infotainment system screen will change.

### Odometer

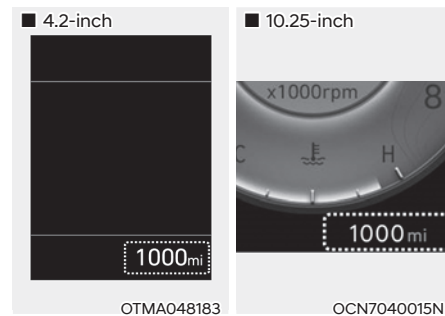

The odometer indicates the total distance that the vehicle has been driven and should be used to determine when periodic maintenance is required.

### Distance to empty

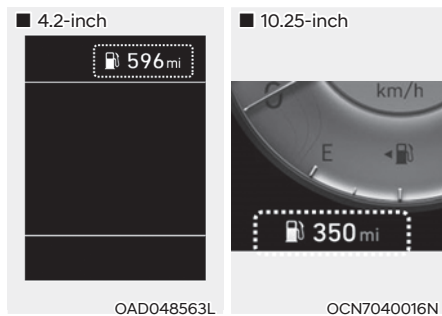

- The distance to empty is the estimated mileage the vehicle can be driven with the remaining fuel.
- If the estimated distance is below 1 mi. (1 km), the trip computer will display “---” as distance to empty. When this occurs, the remaining fuel is very low. Refuel the vehicle immediately.

### **i** Information

- **If the vehicle is not on level ground or the battery power has been interrupted, the distance to empty function may not operate correctly.**
- **The distance to empty may differ from the actual driving distance as it is an estimate of the available driving distance.**
- **The Distance to Empty indicator may not change accurately if less than 1.5 gallons of fuel are added to the vehicle.**
- **The distance to empty may vary significantly based on driving conditions, driving habits, and condition of the vehicle.**

### Fuel economy (for 10.25-inch cluster)



The average fuel economy (1) and instant fuel economy (2) is displayed at the bottom of the cluster.

### Automatic reset

To automatically reset the average fuel economy, select between "After Ignition" or "After Refueling" from the Settings menu in the infotainment system screen.

## Transmission Shift Indicator

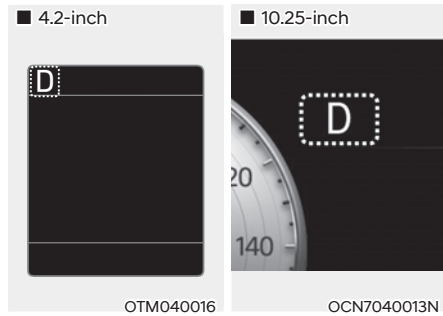

The Transmission Shift Indicator is shown in the upper corner of the LCD display to indicate the current gear or Park(P).

## Warning and Indicator Lights

### **i** Information

Make sure that all warning lights are OFF after starting the engine. If any light is still ON, this indicates a situation that needs attention.

#### **Seat belt warning light**



This warning light informs the driver that the seat belt is not fastened.

**For more details, refer to “Seat Belts” section in chapter 3.**

#### **Air bag warning light**



**This warning light illuminates:**

- When you turn the ignition switch or the Engine Start/Stop button to the ON position.
  - It illuminates for approximately 3–6 seconds and then goes off.
- When there is a malfunction with the SRS.

If the Air Bag warning light remains illuminated while driving, have the vehicle inspected by an authorized HYUNDAI dealer.

**Parking brake warning light**



**This warning light illuminates:**

- When you set the ignition switch or the Engine Start/Stop button to the ON position.
  - The parking brake & brake fluid warning light illuminates for about 3 seconds and will then turn off once the parking brake is released.
- Whenever the parking brake is applied.
- Whenever the brake fluid level in the reservoir is low.
  - If the warning light illuminates with the parking brake released, it indicates the brake fluid level in the reservoir is low.

**If the brake fluid level in the reservoir is low:**

1. Drive carefully to the nearest safe location and stop your vehicle.
2. With the engine stopped, check the brake fluid level immediately and add fluid as required (**For more details, refer to “Brake Fluid” section in chapter 9**). After adding brake fluid, check all brake components for fluid leaks. If a brake fluid leak is found, or if the warning light remains on, or if the brakes do not operate properly, do not drive the vehicle. Have the vehicle inspected by an authorized HYUNDAI dealer.

**Dual-diagonal braking system**

Your vehicle is equipped with dual-diagonal braking system. This means you still have braking on two wheels even if one of the dual systems should fail.

With only one of the dual systems working, more than normal pedal travel and greater pedal pressure is required to stop the vehicle.

Also, the vehicle will not stop in as short a distance with only a portion of the brake system working.

If you experience a malfunction with the brake system while driving, attempt to slow your vehicle by coasting or by using engine braking. You may be able to reduce your vehicle speed by manually downshifting to a lower gear. Use Manual Shift Mode using either the gear shift lever or the paddle shifters (if equipped) to shift to a lower gear.



**WARNING**

**Parking Brake & Brake Fluid warning light**

**Driving the vehicle with a warning light ON is dangerous. If the Parking Brake warning light illuminates with the parking brake released, it indicates that the brake fluid level is low.**

**If this occurs, have the vehicle inspected by an authorized HYUNDAI dealer.**

### **Anti-lock Brake System (ABS) warning light**



This warning light illuminates:

- When you set the ignition switch or the Engine Start/Stop button to the ON position.
  - The ABS warning light illuminates for about 3 seconds and then goes off.
- Whenever there is a malfunction with the ABS.

Note that the hydraulic braking system will still be operational even if there is a malfunction with the ABS.

If the ABS warning light remains illuminated while driving, have the vehicle inspected by an authorized HYUNDAI dealer.

### **Electronic Brake Force Distribution (EBD) system warning light**



When the ABS warning and Parking Brake warning lights are on simultaneously, it may indicate a problem with the Electronic Brake Force Distribution system.

If both the ABS warning light and the Parking Brake warning light remain illuminated while driving, have the vehicle inspected by an authorized HYUNDAI dealer.



### **WARNING**

#### **Electronic Brake Force Distribution (EBD) system warning light**

When both ABS and Parking Brake warning lights are on, the brake system will not work normally and you may experience an unexpected and dangerous situation during sudden braking.

If this occurs, avoid high speed driving and abrupt braking.

Have the vehicle inspected by an authorized HYUNDAI dealer as soon as possible.

### **NOTICE**

#### **Electronic Brake Force Distribution (EBD) system warning light**

When the ABS warning light is on or both ABS and Parking Brake warning lights are on, the speedometer, odometer, or tripmeter may not work. Also, the EPS warning light may illuminate and the steering effort may increase or decrease.

If both the ABS warning light and the Parking Brake warning light remain illuminated while driving, have the vehicle inspected by an authorized HYUNDAI dealer.

**Electric Power Steering (EPS) warning light**



This warning light illuminates:

- When you set the ignition switch or the Engine Start/Stop button to the ON position.
  - The electric power steering warning light illuminates for about 3 seconds and then goes off.
- Whenever there is a malfunction with the electric power steering.

If the EPS warning light remains illuminated while driving, have the vehicle inspected by an authorized HYUNDAI dealer.

**Charging system warning light**



This warning light illuminates:

When there is a malfunction with either the alternator or electrical charging system.

**If there is a malfunction with either the alternator or electrical charging system:**

1. Drive carefully to the nearest safe location and stop your vehicle.
2. Turn the engine off and check the alternator drive belt for looseness or breakage.

If the belt is adjusted properly, there may be a problem in the electrical charging system.

If the Charging system warning light remains illuminated while driving, have the vehicle inspected by an authorized HYUNDAI dealer.

**Engine oil pressure warning light**



This warning light illuminates:

When the engine oil pressure is low.

**If the engine oil pressure is low:**

- Drive carefully to the nearest safe location and stop your vehicle.
- Turn the engine off and check the engine oil level (For more details, refer to “Engine Oil” section in chapter 9). If the level is low, add oil as required.

If the warning light remains on after adding oil or if oil is not available, have the vehicle inspected by an authorized HYUNDAI dealer.

(Continued driving with the warning light on may cause engine failure.)

** Information**

**When engine oil pressure decreases due to insufficient engine oil, etc., the Engine Oil Pressure warning light will illuminate. In addition, the enhanced engine protection system which limits engine power will be activated. If the engine oil pressure is restored, the Engine Oil Pressure warning light and the enhanced engine protection system will turn off. However, for gasoline 2.5 GDI engine and 2.5 turbo engine, when the engine oil pressure is restored, the warning light and the enhanced engine protection system will turn off after the engine is restarted.**

**NOTICE**

- If the engine does not stop immediately after the Engine Oil Pressure warning light is illuminated, severe damage could result.
- If the warning light stays on while the engine is running, it indicates that there may be serious engine damage or malfunction. In this case:
  1. Stop the vehicle as soon as it is safe to do so.
  2. Turn off the engine and check the oil level. If the oil level is low, fill the engine oil to the proper level.
  3. Start the engine again. If the warning light stays on after the engine is started, turn the engine off immediately. If this occurs, have the vehicle inspected by an authorized HYUNDAI dealer.

**Low fuel level warning light**

This warning light illuminates:

When the fuel tank is nearly empty.

Add fuel as soon as possible.

**NOTICE**

Driving with the Low Fuel Level warning light on or with the fuel level below "E" or "- -" on the Distance to Empty indicator can cause the engine to misfire and damage the catalytic converter.

**Malfunction Indicator Lamp (MIL)**

This indicator light illuminates:

- When you set the ignition switch or the Engine Start/Stop button to the ON position.
  - The malfunction indicator light illuminates for about 3 seconds and then goes off.
- Whenever there is a malfunction with either the emission control system or the engine or the vehicle powertrain. If the MIL warning light remains illuminated while driving, have the vehicle inspected by an authorized HYUNDAI dealer.
- If enhanced engine protection system becomes activated due to lack of engine oil, engine power will be limited. If such condition continues repeatedly, The Malfunction Indicator Lamp will illuminate.

**NOTICE**

- Driving with the Malfunction Indicator Lamp (MIL) on may cause damage to the emission control system which could affect drivability and/or fuel economy.
- If the enhanced engine protection system becomes activated due to lack of engine oil, engine power will be limited. If such condition continues repeatedly, the Malfunction Indicator Lamp will illuminate.

**NOTICE**

If the Malfunction Indicator Lamp (MIL) illuminates, potential catalytic converter damage is possible which could result in loss of engine power.

If this occurs, have the vehicle inspected by an authorized HYUNDAI dealer as soon as possible.

**Electronic Parking Brake (EPB) warning light**

**EPB**

This warning light illuminates:

- When you set the ignition switch or the Engine Start/Stop button to the ON position.
  - The EPB warning light illuminates for about 3 seconds and then goes off.
- Whenever there is a malfunction with EPB.

If the EPB warning light remains illuminated while driving, have the vehicle inspected by an authorized HYUNDAI dealer.

***i* Information**

The Electronic Parking Brake (EPB) warning light may illuminate when the Electronic Stability Control (ESC) indicator light comes on to indicate that ESC is not working properly. This does not indicate malfunction of EPB.



**AUTO HOLD indicator light****This indicator light illuminates:**

- [White] When you activate Auto Hold by pressing the AUTO HOLD switch.
- [Green] When you stop the vehicle completely by depressing the brake pedal with Auto Hold activated.
- [Yellow] Whenever there is a malfunction with the Auto Hold function.

If the AUTO HOLD indicator light remains YELLOW while driving, have the vehicle inspected by an authorized HYUNDAI dealer.

**For more details, refer to “Electronic Parking Brake (EPB)” section in chapter 6.**

**Low tire pressure warning light****This warning light illuminates:**

- When you set the ignition switch or the Engine Start/Stop button to the ON position.
  - The low tire pressure warning light illuminates for approximately 3 seconds and then goes off.
- When one or more of your tires are significantly underinflated. (The location of the underinflated tires are displayed on the LCD display.)

**For more details, refer to “Tire Pressure Monitoring System (TPMS)” section in chapter 8.**

**This warning light remains ON after blinking for approximately 60 seconds, or repeatedly blinks ON and OFF in 3 second intervals:**

When there is a malfunction with the TPMS.

If this occurs, have the vehicle inspected by an authorized HYUNDAI dealer as soon as possible.

**For more details, refer to “Tire Pressure Monitoring System (TPMS)” section in chapter 8.**

**WARNING****Safe Stopping**

- **The TPMS cannot alert you to severe and sudden tire damage caused by external factors.**
- **If you notice any vehicle instability, immediately take your foot off the accelerator pedal, apply the brakes gradually with light force, and slowly move to a safe position off the road.**

**Forward Safety warning light**



**This warning light illuminates:**

- When you set the ignition switch or the Engine Start/Stop button to the ON position.
  - The Forward Safety warning light illuminates for approximately 3 seconds and then goes off.
- Whenever there is a malfunction with Forward Collision-Avoidance Assist.

If this occurs, have the vehicle inspected by an authorized HYUNDAI dealer.

**For more details, refer to “Forward Collision-Avoidance Assist (FCA)” section in chapter 7.**

**Lane Safety indicator light**



**This indicator light illuminates:**

- [Green] When Lane Keeping Assist operating conditions are satisfied.
- [White] When Lane Keeping Assist operating conditions are not satisfied.
- [Yellow] Whenever there is a malfunction with Lane Keeping Assist.

If this occurs, have the vehicle inspected by an authorized HYUNDAI dealer.

**For more details, refer to “Lane Keeping Assist (LKA)” section in chapter 7.**

**4 Wheel Drive (AWD) warning light**



**This warning light illuminates:**

Whenever there is a malfunction with the AWD system.

If this occurs, have the vehicle inspected by an authorized HYUNDAI dealer.

**For more details, refer to “4 Wheel Drive (AWD)” section in chapter 6.**

#### 4 Wheel Drive (AWD) LOCK Indicator Light



This indicator light illuminates:

- Once you set the ignition switch or Engine Start/Stop Button to the ON position.
  - It illuminates for approximately 3 seconds and then goes off.
- When you select AWD Lock mode by pressing the AWD LOCK button.
  - The AWD LOCK mode is to increase the drive power when driving on wet pavement, snow covered roads and/or off-road.

#### **NOTICE**

**Do not use AWD LOCK mode on dry paved roads or highway, it can cause noise, vibration or damage of AWD related parts.**

#### LED headlight warning light



This warning light illuminates:

- When you set the ignition switch or the Engine Start/Stop button to the ON position.
  - The LED headlight warning light illuminates for approximately 3 seconds and then goes off.
- Whenever there is a malfunction with the LED headlight.

If the LED headlight warning light remains illuminated while driving, have the vehicle inspected by an authorized HYUNDAI dealer.

**This warning light blinks:**

Whenever there is a malfunction with a LED headlight related part.

If this occurs, have the vehicle inspected by an authorized HYUNDAI dealer.

#### **NOTICE**

**Continuous driving with the LED Headlight warning light on or blinking can reduce LED headlight life.**

### **Icy road warning light**



This warning light is to warn the driver the road may be icy.

When the temperature on the outside temperature gauge is approximately below 40°F (4°C), the Icy Road warning light and Outside Temperature Gauge blinks and then illuminates. Also, the warning chime sounds 1 time.

You can activate or deactivate Icy Road Warning function from the User Settings menu in the cluster LCD display.

Select:

- Setup → User Settings → Cluster → Icy Road Warning

### ***i* Information**

**If the Icy Road warning light appears while driving, you should drive more attentively and safely refraining from over-speeding, rapid acceleration, sudden braking or sharp turning, etc.**

### **Electronic Stability Control (ESC) indicator light**



**This indicator light illuminates:**

- When you set the ignition switch or the Engine Start/Stop button to the ON position.
  - The Electronic Stability Control indicator light illuminates for about 3 seconds and then goes off.
- Whenever there is a malfunction with ESC system.

If this occurs, have the vehicle inspected by an authorized HYUNDAI dealer.

**This indicator light blinks:**

While ESC is operating.

**For more details, refer to “Electronic Stability Control (ESC)” section in chapter 6.**

### **Electronic Stability Control (ESC) OFF indicator light (if equipped)**



**This indicator light illuminates:**

- When you set the ignition switch or the Engine Start/Stop button to the ON position.
  - The ESC OFF indicator light illuminates for approximately 3 seconds and then goes off.
- When you deactivate ESC system by pressing the ESC OFF button.

**For more details, refer to “Electronic Stability Control (ESC)” section in chapter 6.**

**Immobilizer Indicator Light  
(without smart key)  
(if equipped)**



**This indicator light illuminates:**

- When the vehicle detects the immobilizer in the key with the ignition switch in the ON position.
  - At this time, you can start the engine.
  - The indicator light goes off after starting the engine.

**This indicator light blinks:**

- When there is a malfunction with the immobilizer system.  
In this case, have the vehicle inspected by an authorized HYUNDAI dealer.

**Immobilizer Indicator Light  
(with smart key)**



**This indicator light illuminates for up to 30 seconds:**

- When the vehicle detects the smart key in the vehicle with the Engine Start/Stop button in the ACC or ON position.
  - At this time, you can start the engine.
  - The indicator light goes off after starting the engine.

**This indicator light blinks for a few seconds:**

- When the smart key is not in the vehicle.
  - At this time, you cannot start the engine.

**This indicator light illuminates for 2 seconds and goes off:**

- If the smart key is in the vehicle and the Engine Start/Stop button is ON, but the vehicle cannot detect the smart key.

In this case, have the vehicle inspected by an authorized HYUNDAI dealer.

**This indicator light blinks:**

- When there is a malfunction with the immobilizer system.  
In this case, have the vehicle inspected by an authorized HYUNDAI dealer.

**Downhill Brake Control (DBC) indicator light**



**This indicator light illuminates:**

- When you set the ignition switch or the Engine Start/Stop button to the ON position.
  - The downhill brake control indicator light illuminates for about 3 seconds and then goes off.
- When you activate the system by pressing the DBC button.

**This indicator light blinks:**

When Downhill Brake Control system is operating.

**This indicator light illuminates yellow:**

Whenever there is a malfunction with Downhill Brake Control system.

If this occurs, have the vehicle inspected by an authorized HYUNDAI dealer.

**For more details, refer to "Downhill Brake Control (DBC)" section in chapter 6.**

**Turn signal indicator light**



**This indicator light blinks:**

When you operate the turn signal indicator stalk.

If any of the following occur, there may be a malfunction with the turn signal system.

- The turn signal indicator light illuminates but does not blink
- The turn signal indicator light blinks rapidly
- The turn signal indicator light does not illuminate at all

If any of these conditions occur, have the vehicle inspected by an authorized HYUNDAI dealer.

**High beam indicator light**



**This indicator light illuminates:**

- When the headlamps are on and in the high beam position
- When the turn signal lever is pulled into the Flash-to-Pass position.

**High Beam Assist indicator light**

**This indicator light illuminates:**

When the high-beam is on with the light switch in the AUTO position.

If your vehicle detects oncoming or preceding vehicles, High Beam Assist will switch the high beam to low beam automatically.

**For more details, refer to “High Beam Assist (HBA)” section in chapter 5.**

**Cruise Indicator Light (if equipped)**

**This indicator light illuminates:**

When the cruise control system is enabled.

**For more details, refer to "Smart Cruise Control (SCC)" in chapter 7.**

**Master warning light**

**This warning light illuminates:**

When there is a malfunction in operation in any of the following systems:

- Forward Collision-Avoidance Assist malfunction
- Forward Collision-Avoidance Assist radar blocked
- Blind-Spot Collision Warning malfunction (if equipped)
- Blind-Spot Collision Warning radar blocked (if equipped)
- LED headlamp malfunction (if equipped)
- High Beam Assist malfunction (if equipped)
- Smart Cruise Control with Stop & Go malfunction (if equipped)
- Smart Cruise Control with Stop & Go radar blocked (if equipped)
- Tire Pressure Monitoring System (TPMS) malfunction

To identify the details of the warning, look at the LCD display.

## LCD Display Messages for Vehicles Equipped with Smart Key

### ***Shift to P***

This message is displayed if you try to turn off the vehicle without the gear in the P (Park) position.

If this occurs, the Engine Start/Stop button turns to the ACC position.

### ***Low key battery***

When the Engine Start/Stop button is pressed to turn OFF the engine, this message may be displayed. This message indicates that the internal battery of the Smart Key is low. Consider replacing the Smart Key internal battery.

### ***Press START button while turning wheel***

This message is displayed if the steering wheel does not unlock normally when the Engine Start/Stop button is pressed.

You should press the Engine Start/Stop button while turning the steering wheel right and left.

### ***Check steering wheel lock system***

This message is displayed if the steering wheel does not lock normally while the Engine Start/Stop button is pressed to the OFF position.

### ***Press brake pedal to start engine***

This message is displayed if the Engine Start/Stop button changes to the ACC position twice by pressing the button repeatedly without depressing the brake pedal.

You can start the vehicle by depressing the brake pedal and then pressing the Engine Start/Stop button.

### ***Key not in vehicle***

This message is displayed if the smart key is not in the vehicle when you leave the vehicle with the Engine Start/Stop button in the ON or Start position.

Always turn off the engine before leaving your vehicle.

### ***Key not detected***

This message is displayed if the smart key is not detected when you press the Engine Start/Stop button.

### ***Press START button again***

This message is displayed if you were unable to start the vehicle when the Engine Start/Stop button was pressed.

If this occurs, attempt to start the engine by pressing the Engine Start/ Stop button again.

If the warning message appears each time you press the Engine Start/Stop button, have the vehicle inspected by an authorized HYUNDAI dealer.



***Press START button with key***

This message is displayed if you press the Engine Start/Stop button while the warning message “Key not detected” is displayed.

At this time, the immobilizer indicator light blinks.

***Check BRAKE SWITCH fuse***

This message is displayed if the brake switch fuse is disconnected.

You need to replace the fuse with a new one before starting the engine.

If that is not possible, you can start the engine by pressing the Engine Start/Stop button for 10 seconds in the ACC position.

***Shift to P or N to start engine***

This message is displayed if you try to start the engine in any other position except P (Park) or N (Neutral).

***i* Information**

**You can start the engine with the gear in N (Neutral). But, for your safety, we recommend that you start the engine with the gear shifted to P (Park).**

***Battery discharging due to external electrical devices***

This message is displayed if the vehicle battery voltage is low or if a current draw is detected that could drain the vehicle battery.

Check to see that there are no non-factory external electronic devices connected to the vehicle battery system, otherwise battery discharge may occur.

If this message appears in the LCD cluster and there are no other non-factory electronic devices connected to the vehicle, have the vehicle inspected by an authorized HYUNDAI dealer.

**Door, Hood, Tailgate open indicator**

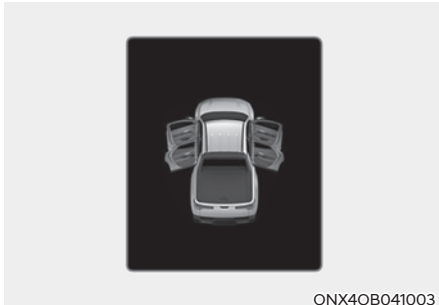

This warning is displayed if any door or hood or tailgate is left open. The warning will indicate which door is open in the display.



**CAUTION**

Before driving the vehicle, you should confirm that the door/ hood/tailgate is fully closed.

Also, check there is no door/hood/tailgate open warning light or message displayed on the instrument cluster.

**Sunroof open indicator (if equipped)**

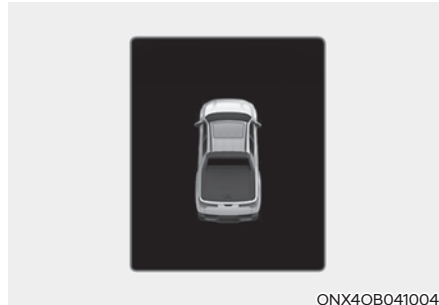

This warning is displayed if you turn off the engine when the sunroof is open. Close the sunroof securely before leaving your vehicle.

**Low tire pressure**



This warning message is displayed if the tire pressure is low. The corresponding tire on the vehicle will be illuminated.

For more details, refer to “Tire Pressure Monitoring System (TPMS)” section in chapter 8.

**Lights**

This indicator displays which exterior light is selected using the lighting control.

You can activate or deactivate Wiper/Lights display function from the User Settings menu in the cluster LCD display. Select:

- Setup → User settings → Cluster → Wiper/Lights display

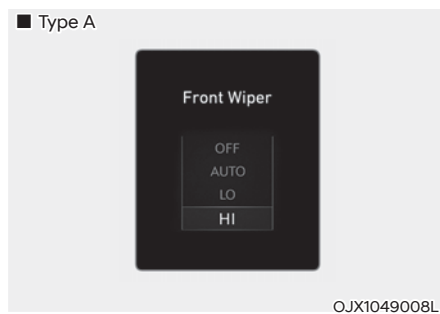
**Wiper**

This indicator displays which wiper speed is selected using the wiper control.

You can activate or deactivate Wiper/Lights display function from the User Settings menu in the cluster LCD display. Select:

- Setup → User settings → Cluster → Wiper/Lights display

**Low washer fluid (if equipped)**

This message is displayed if the washer fluid level in the reservoir is nearly empty. Have the washer fluid reservoir refilled.

**Low fuel**

This message is displayed if the fuel tank is almost out of fuel.

When this message is displayed, the low fuel level warning light in the cluster will come on.

It is recommended to look for the nearest fueling station and refuel as soon as possible.

**Low engine oil**

This warning message is displayed when the engine oil level should be checked.

If this warning message is displayed, check the engine oil level as soon as possible and add engine oil as required.

Slowly pour the recommended oil little by little into a funnel.

Use only the specified engine oil. (Refer to "Recommended Lubricants and Capacities" section in chapter 2.)

Do not overfill the engine oil. Make sure the oil level is not above F (Full) mark on the dipstick.

***Engine overheated***

This message is displayed when the engine coolant temperature is above 248°F (120°C). This means that the engine is overheated and may be damaged.

**If your vehicle is overheated, refer to “Overheating” section in chapter 8.**

***Check headlight***

This warning message is displayed if the headlamps are not operating properly.

In addition, if a specific lamp (turn signal lamp etc.) is not operating properly, the warning message according to a specific lamp (turn signal lamp etc.) is displayed.

A corresponding bulb may need to be replaced.

Make sure to replace the burned out bulb with a new one of the same wattage rating.

***Check turn signal***

This message is displayed if the turn signal lamps are not operating properly. A lamp may need to be replaced.

Make sure to replace the burned out bulb with a new one of the same wattage rating.

***Check headlamp LED***

This message is displayed if there is a problem with the LED headlamp. Have the vehicle inspected by an authorized HYUNDAI dealer.

## LCD DISPLAY

### LCD Display Control

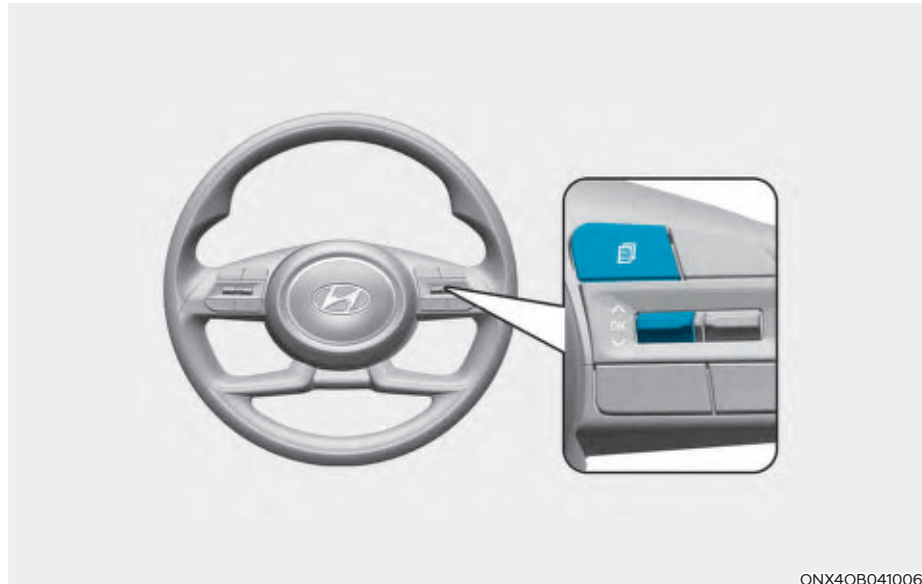

ONX4OB041006





The LCD display modes can be changed by using the control buttons.

Switch	Function
	MODE button for changing modes
	MOVE switch for changing items
OK	SELECT/RESET button for setting or resetting the selected item

### Information

When the infotainment system is applied, only the User's Setting mode on the infotainment system is supported but the User's Setting mode on the instrument cluster is not supported.

## View Modes

View modes	Symbol	Explanation
Driving Assist		<p>This mode displays the state of :</p> <ul style="list-style-type: none"> <li>- Lane Keeping Assist</li> <li>- Smart Cruise Control (if equipped)</li> <li>- Highway Driving Assist (if equipped)</li> <li>- Driver Attention Warning (DAW)</li> </ul> <p><b>For more information, refer to "Lane Keeping Assist (LKA)", "Driver Attention Warning (DAW)", "Smart Cruise Control (SCC)", "Highway Driving Assist (HDA)" in chapter 7 and "4 Wheel Drive (AWD)" in chapter 6.</b></p>
Trip Computer		<p>This mode displays driving information such as the tripmeter, fuel economy, etc.</p> <p><b>For more details, refer to "Trip Computer" in this chapter.</b></p>
Turn By Turn (TBT)		<p>This mode displays the state of the navigation.</p>
User Settings		<p>In this mode, you can change settings of the doors, lamps, etc.</p>
Warning		<p>The Warning mode displays warning messages related to the vehicle when one or more systems are not operating normally.</p>

**The information provided may differ depending on which functions are applicable to your vehicle.**

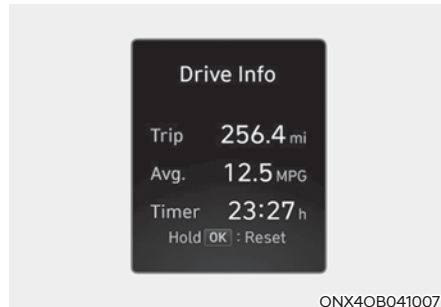
**Trip computer mode**

ONX4OB041007

The trip computer mode displays information related to vehicle driving parameters including fuel economy, tripmeter information and vehicle speed.

**For more information, refer to "Trip Computer" in this chapter.**

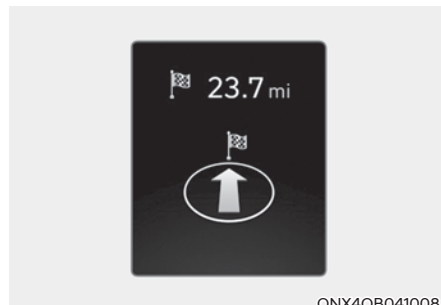
**Turn By Turn (TBT) mode**

ONX4OB041008

Turn-by-turn navigation, distance/time to destination information is displayed when Turn by Turn view is selected.

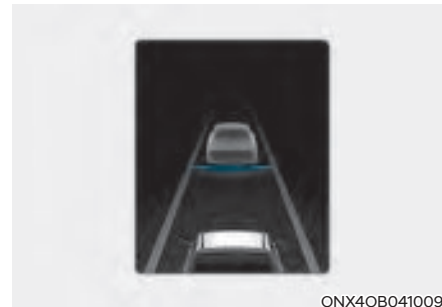
**Driving Assist mode**

ONX4OB041009

**LKA/SCC/HDA**

This mode displays the state of Lane Keeping Assist, Smart Cruise Control and Highway Driving Assist.

**For more details, refer to each system information in chapter 7.**

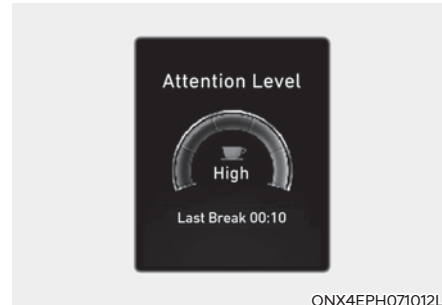

ONX4EPH071012L

**Driver Attention Warning**

This mode displays the state of Driver Attention Warning.

**For more details, refer to "Driver Attention Warning (DAW)" in chapter 7.**

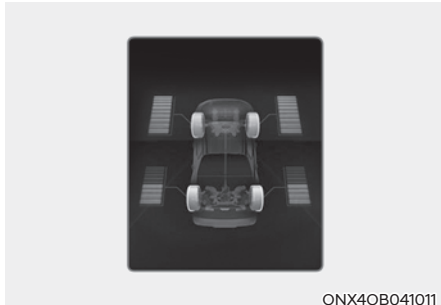

**Driving force distribution (AWD)**

This mode displays information related to AWD driving force.

If the vehicle is in AWD lock state, this mode is not displayed.

**For detailed information, refer to the "Four Wheel Drive" in the chapter 6.**

**Master warning group**

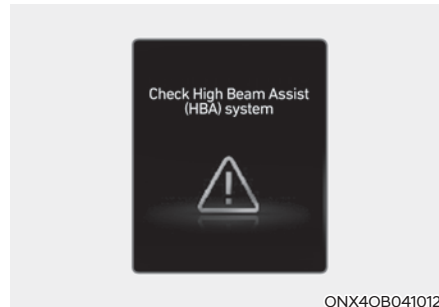

This warning light informs the driver the following situations.

- Forward Collision-Avoidance Assist malfunction
- Forward Collision-Avoidance Assist radar blocked
- Blind-Spot Collision Warning malfunction (if equipped)
- Blind-Spot Collision Warning radar blocked (if equipped)
- LED headlamp malfunction (if equipped)
- High Beam Assist malfunction (if equipped)
- Smart Cruise Control malfunction (if equipped)
- Smart Cruise Control radar blocked (if equipped)
- Tire Pressure Monitoring System (TPMS) malfunction

The Master Warning Light illuminates if one or more of the above warning situations occur.

At this time, a Master Warning icon (⚠) will appear beside the User Settings icon (⚙), on the LCD display.

If the warning situation is solved, the master warning light will be turned off and the Master Warning icon will disappear.





### Tire Pressure

This mode displays information related to Tire Pressure.

**For more details, refer to "Tire Pressure Monitoring System (TPMS)" in chapter 8.**

### User Settings Mode



In this mode, you can change the settings of the instrument cluster, doors, lamps, etc.

1. Driver Assistance
2. Cluster
3. Lights
4. Door
5. Convenience
6. Units

**The information provided may differ depending on which functions are applicable to your vehicle.**

#### Quick guide (Help)

This mode provides quick guides for the systems in the User Settings mode.

Select an item, press and hold the OK button.

**For more details about each system, refer to this Owner's Manual.**

#### **i** Information

**When the infotainment system is applied, only the User's Setting mode on the infotainment system is supported but the User's Setting mode on the instrument cluster is not supported.**

1. Driver Assistance

Items	Explanation
Driving Convenience	<ul style="list-style-type: none"> <li>• Highway Driving Assist (if equipped) To activate or deactivate Highway Driving Assist. <b>For more details, refer to "Highway Driving Assist (HDA)" in chapter 7.</b></li> <li>• Auto. Speed Change (if equipped) To activate or deactivate Navigation-based Smart Cruise Control. <b>For more details, refer to "Navigation-based Smart Cruise Control (NSCC)" in chapter 7.</b></li> </ul>
Speed Limit (if equipped)	<p>To adjust the Speed Limit function.</p> <ul style="list-style-type: none"> <li>• Speed Limit Offset</li> <li>• Speed Limit Assist / Speed Limit Warning / Off</li> </ul> <p><b>For more details, refer to "Intelligent Speed Limit Assist (ISLA)" in chapter 7</b></p>
Warning Timing	<p>To adjust the warning timing of Driver Assistance systems.</p> <ul style="list-style-type: none"> <li>• Normal / Late</li> </ul>
Warning Volume	<p>To adjust the warning volume of Driver Assistance systems.</p> <ul style="list-style-type: none"> <li>• High / Medium / Low</li> </ul>
Haptic Warning	<ul style="list-style-type: none"> <li>• To activate or deactivate steering wheel vibration warning for Driver Assistance systems such as Forward Safety system.</li> </ul>
Driver Attention Warning	<ul style="list-style-type: none"> <li>• Leading Vehicle Departure Alert</li> </ul> <p>To activate or deactivate Leading Vehicle Departure Alert.</p> <ul style="list-style-type: none"> <li>• Inattentive Driving Warning</li> </ul> <p>To alert the driver's inattentive driving. <b>For more details, refer to "Driver attention Warning (DAW)" in chapter 7.</b></p>
Forward Safety	<p>To adjust Forward Collision-Avoidance Assist</p> <ul style="list-style-type: none"> <li>- Active Assist / Warning Only / Off</li> </ul> <p><b>For more details, refer to "Forward Collision-Avoidance Assist (FCA)" in chapter 7.</b></p>
Lane Safety	<p>To adjust Lane Keeping Assist</p> <ul style="list-style-type: none"> <li>- Active Assist / Warning Only / Off</li> </ul> <p><b>For more details, refer to "Lane Keeping Assist (LKA)" in chapter 7.</b></p>

Items	Explanation
Blind-Spot Safety	<ul style="list-style-type: none"> <li>• Blind-Spot View (if equipped) To activate or deactivate Blind-Spot View. <b>For more details, refer to "Blind-Spot View Monitor (BVM)" in chapter 7.</b></li> <li>• Safe Exit Warning (if equipped) To activate or deactivate Safe Exit Warning. <b>For more details, refer to "Safe Exit Warning (SEW)" in chapter 7.</b></li> </ul>
	<p>To adjust Blind-Spot Collision-Avoidance Assist. - Active Assist / Warning Only / Off <b>For more details, refer to "Blind-Spot Collision-Avoidance Assist (BCA)" in chapter 7.</b></p>
Parking Safety	<ul style="list-style-type: none"> <li>• Rear Cross-Traffic Safety (if equipped) To activate or deactivate Rear Cross-Traffic Collision-Avoidance Assist. <b>For more details, refer to "Rear Cross-Traffic Collision-Avoidance Assist (RCCA)" in chapter 7.</b></li> <li>• Surround View Monitor Auto On (if equipped) To activate or deactivate Surround View Monitor Auto On. <b>For more details, refer to "Surround View Monitor (SVM)" in chapter 7.</b></li> </ul>

## 2. Cluster

Items	Explanation
Select Theme	You can select the theme of the cluster. <ul style="list-style-type: none"> <li>• Type A Cluster : Theme A / Theme B / Theme C</li> <li>• Type B Cluster : Link to Drive Mode / Classic A / Classic B / Classic C / Cube</li> </ul>
Service Interval	To activate or deactivate the service interval function.
Reset fuel economy	To reset the fuel economy displayed <ul style="list-style-type: none"> <li>- At vehicle start</li> <li>- After refueling</li> <li>- Manually</li> </ul>
Wiper/Lights Display	<ul style="list-style-type: none"> <li>• To activate or deactivate the Wiper/Light mode.</li> </ul> When activated, the LCD display shows the selected Wiper/Light mode whenever you changed the mode.
Icy Road Warning	To activate or deactivate the icy road warning.
Welcome Sound	To activate or deactivate the welcome sound.

### Information

To use the service interval menu, consult an authorized HYUNDAI dealer.

If the service interval is activated and the time and distance is adjusted, messages are displayed in the following situations each time the vehicle is turned on.

- **Service in:** Displayed to inform the driver the remaining mileage and days to service.
- **Service required:** Displayed when the mileage and days to service has been reached or passed.

### Information

If any of the following conditions occur, the mileage and number of days to service may be incorrect.

- The battery cable is disconnected.
- The fuse switch is turned off.
- The battery is discharged.

### 3. Lights

Items	Explanation
Illumination	To adjust the illumination level. • Level 1-20
One Touch Turn Signal	• Off : The one touch turn signal function will be deactivated. • 3, 5, 7 Flashes : The turn signal indicator will blink 3, 5, or 7 times when the turn signal lever is moved slightly. <b>For more details, refer to "Lighting" in chapter 5.</b>
Ambient Light Brightness (if equipped)	• Off • Level 1/ Level 2/ Level 3/ Level 4
Ambient Light Color (if equipped)	• Polar White/Moon White/Ice Blue/Ocean Blue/Jade Green/Orchid Green/Freesia Yellow/ Sunrise Red/Aurora Purple/Lightening Violet
Headlight Delay	To activate or deactivate the headlamp delay function. <b>For more details, refer to "Lighting" in chapter 5.</b>
High Beam Assist	To activate or deactivate High Beam Assist function. <b>For more details, refer to "High Beam Assist (HBA)" in chapter 5.</b>

#### 4. Door

Items	Explanation
Auto Lock	<ul style="list-style-type: none"> <li>• Enable on Shift : All doors will be automatically locked if the shift lever is shifted from the P (Park) position to the R (Reverse), N (Neutral), or D (Drive) position. (only when the engine is running.)</li> <li>• Enable on Speed : All doors will be automatically locked when the vehicle speed exceeds 9.3 mph (15 km/h).</li> <li>• Off : The auto door lock operation will be deactivated.</li> </ul>
Auto Unlock	<ul style="list-style-type: none"> <li>• On Shift to P: All doors will be automatically unlocked if the shift lever is shifted to the P (Park) position. (only when the engine is running.)</li> <li>• On key out/On vehicle off : All doors will be automatically unlocked when the ignition key is removed from the ignition switch or the Engine Start/ Stop button is set to the OFF position.</li> <li>• Off : The auto door unlock operation will be canceled.</li> </ul>
2 Press Unlock	<ul style="list-style-type: none"> <li>• Off: The two press unlock function will be deactivated. Therefore, all doors will unlock if the door unlock button is pressed.</li> <li>• On: Only the driver's door will unlock if the door unlock button is pressed. When the door unlock button is</li> </ul>

#### 5. Convenience

Items	Explanation
Rear Occupant Alert (if equipped)	To activate or deactivate Rear Occupant Alert. <b>For more details, refer to "Rear Occupant Alert (ROA) system" in chapter 5.</b>
Welcome Mirror/Light	<ul style="list-style-type: none"> <li>• On door unlock : The side view mirrors are unfolded and the welcome light turns on automatically when the doors are unlocked.</li> <li>• On driver approach : The side view mirrors are unfolded and the welcome light turns on automatically when the vehicle is approached with the smart key.</li> </ul> <b>For more details, refer to "Welcome System" in chapter 5."</b>
Wireless Charging System	To activate or deactivate the wireless charging system in the front seat. <b>For more details, refer to "Wireless Smart Phone Charging System" in chapter 5.</b>

## 6. Units

Items	Explanation
Speed Unit	To select the speed unit. • km/h, MPH
Temperature Unit	To select the temperature unit. • °C, °F
Fuel Economy Unit	To select the fuel economy unit. • km/L, L/100km, MPG
Tire Pressure Unit	To select the tire pressure unit. • psi, kPa, bar

### Information

The information provided may differ depending on which functions are applicable to your vehicle.

### Trip Computer (Type A : 4.2" LCD)

The trip computer is a microcomputer-controlled driver information system that displays information related to driving.

#### **i** Information

Some driving information stored in the trip computer (for example Average Vehicle Speed) resets if the battery is disconnected.

#### Trip modes

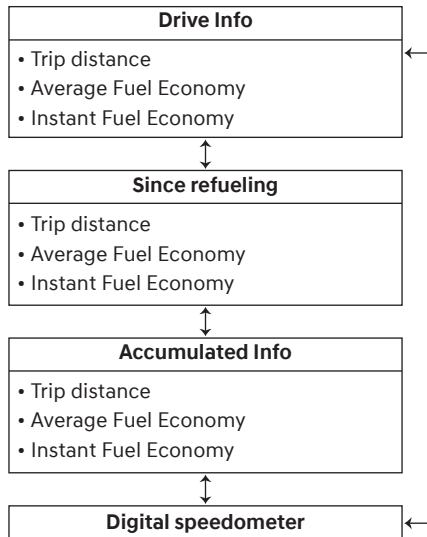

To change the trip mode, toggle the " $\wedge, \vee$ " switch on the steering wheel

- Manual reset
  - To clear the average fuel economy manually, press the OK switch on the steering wheel for more than 1 second when the Average Fuel Economy is displayed.
- Automatic reset
  - To automatically reset the average fuel economy, select between 'After Ignition' or 'After Refueling' from the Settings menu in the instrument cluster.
    - After Ignition: When the engine has been OFF for 3 minutes or longer the average fuel economy will reset automatically.
    - After Refueling: The average fuel economy will reset automatically after adding 6 liters (1.6 gallons) of fuel or more and after driving speed exceeds 1 mph (1 km/h).



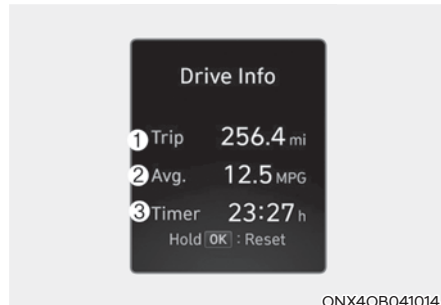

ONX4OB041014

**Drive info**

Trip distance (1), average fuel economy (2), and instant fuel economy (3) are displayed.

The information is combined for each ignition cycle. However, when the engine has been OFF for 3 minutes or longer the Drive Info screen will reset.

To reset manually, press the OK switch on the steering wheel for more than 1 second when 'Drive Info' is displayed.

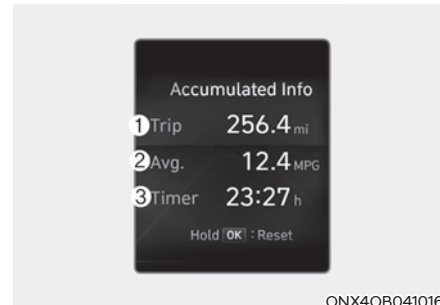

ONX4OB041016

**Accumulated Info**

Accumulated trip distance (1), average fuel economy (2), and instant fuel economy (3) are displayed.

The information is accumulated starting from the last reset.

To reset manually, press the OK switch on the steering wheel for more than 1 second when 'Accumulated Info' is displayed.

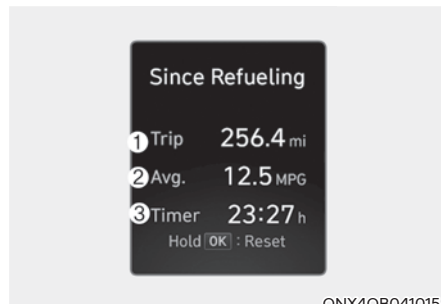

ONX4OB041015

**Since refuel(l)ing**

Trip distance (1), average fuel economy (2), and instant fuel economy (3) after the vehicle has been refueled are displayed.

To reset manually, press the OK switch on the steering wheel for more than 1 second when 'Since Refueling' is displayed.

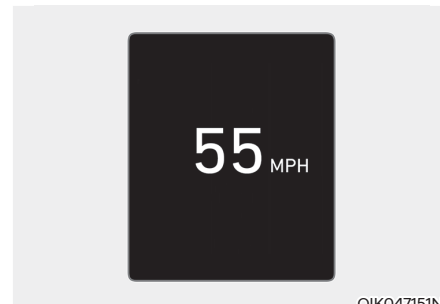

OIK047151N

**Digital speedometer**

Digital speedometer display shows the speed of the vehicle.

### Trip Computer (Type B : 10.25" LCD)

The trip computer is a microcomputer-controlled driver information system that displays information related to driving.

#### **i** Information

Some driving information stored in the trip computer (for example Average Vehicle Speed) resets if the battery is disconnected.

#### Trip modes

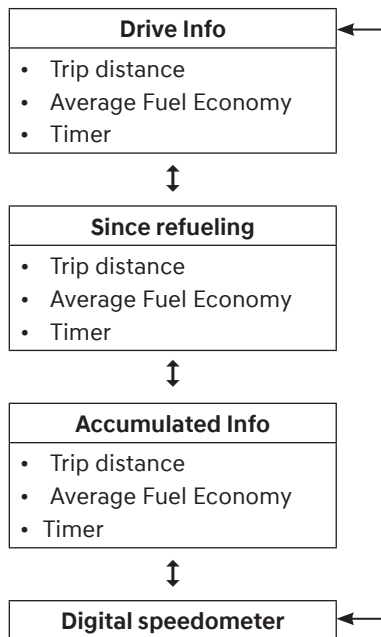

To change the trip mode, toggle the "∧, ∨" switch on the steering wheel

- Manual reset
    - To clear the average fuel economy manually, press the OK switch on the steering wheel for more than 1 second when the Average Fuel Economy is displayed.
  - Automatic reset
    - To automatically reset the average fuel economy, select between 'After Ignition' or 'After Refueling' from the Settings menu in the instrument cluster.
      - After Ignition: When the engine has been OFF for 3 minutes or longer the average fuel economy will reset automatically.
      - After Refueling: The average fuel economy will reset automatically after adding 6 liters (1.6 gallons) of fuel or more and after driving speed exceeds 1 mph (1 km/h).
- \* For 10.25-inch instrument cluster, you can check the fuel economy in the center bottom of the cluster.

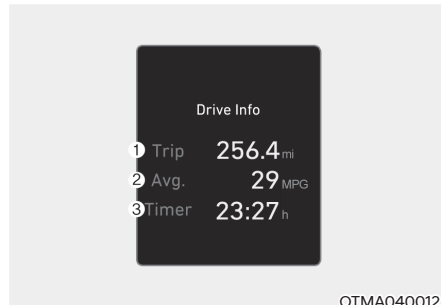

OTMA040012

**Drive info**

Trip distance (1), average fuel economy (2), and total driving time (3) are displayed.

The information is combined for each ignition cycle. However, when the engine has been OFF for 3 minutes or longer the Drive Info screen will reset.

To reset manually, press the OK switch on the steering wheel for more than 1 second when 'Drive Info' is displayed.

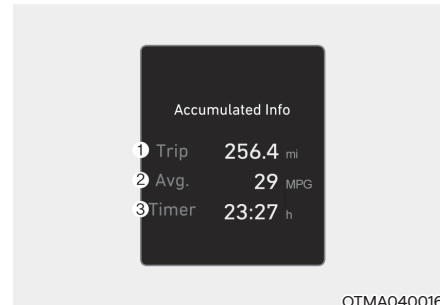

OTMA040016

**Accumulated info**

Accumulated trip distance (1), average fuel economy (2), and total driving time (3) are displayed.

The information is accumulated starting from the last reset.

To reset manually, press the OK switch on the steering wheel for more than 1 second when 'Accumulated Info' is displayed.

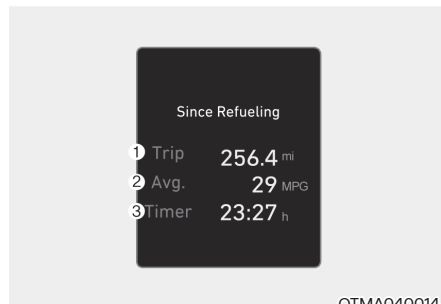

OTMA040014

**Since refueling**

Trip distance (1), average fuel economy (2), and total driving time (3) after the vehicle has been refueled are displayed.

To reset manually, press the OK switch on the steering wheel for more than 1 second when 'Since Refueling' is displayed.

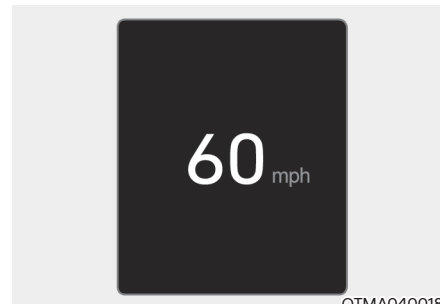

OTMA040018

**Digital speedometer**

Digital speedometer display shows the speed of the vehicle.

## INFOTAINMENT SYSTEM VEHICLE SETTINGS (IF EQUIPPED)



Vehicle Settings in the infotainment system provide user options for a variety of settings including door lock/ unlock features, convenience features, driver assistance settings, etc.

### Vehicle Settings menu

- Driver Assistance
- Cluster
- Climate
- Seat
- Lights
- Door
- Convenience

The information provided may differ depending on which functions are applicable to your vehicle.



### WARNING

**Do not operate the Vehicle Settings while driving. This may cause distraction resulting in an accident.**

### Setting Your Vehicle



1. Press the SETUP button on the head unit of the infotainment system.



2. Select 'Vehicle' and change the setting of the features.

**For detailed information, please refer to the infotainment system manual separately supplied.**

## 5. Convenient Features

Accessing Your Vehicle.....	5-4
Remote Key.....	5-4
Smart Key.....	5-7
Immobilizer System .....	5-14
Hyundai Digital Key .....	5-15
Door Locks.....	5-32
Operating Door Locks From Outside the Vehicle .....	5-32
Operating Door Unlocks from Inside the Vehicle .....	5-34
Auto Door Lock/Unlock Features.....	5-36
Child-protector Rear Door Locks .....	5-36
Theft-alarm System .....	5-37
Rear Occupant Alert (ROA) .....	5-38
Rear Occupant Alert Operation .....	5-38
Steering Wheel.....	5-39
Electric Power Steering (EPS).....	5-39
Tilt / Telescopic Steering .....	5-40
Heated Steering Wheel.....	5-40
Horn.....	5-41
Mirrors .....	5-42
Inside Rearview Mirror.....	5-42
Side View Mirrors .....	5-52
Windows.....	5-54
Power Windows.....	5-55
Rear Sliding Window.....	5-58
Sunroof .....	5-59
Sunshade .....	5-59
Tilt Open/Close.....	5-60
Slide open/close.....	5-60
Automatic Reversal .....	5-61
Resetting the sunroof .....	5-62
Sunroof Open Warning .....	5-63
Exterior Features.....	5-64
Hood.....	5-64
Tailgate.....	5-65
Rear Bumper Steps .....	5-68
Fuel Filler Door .....	5-68



**5**

- Lighting..... 5-71
  - Exterior Lights .....5-71
- High Beam Assist (HBA) .....5-75
  - High Beam Assist Settings.....5-75
  - High Beam Assist Operation.....5-76
  - High Beam Assist Malfunction and Limitations ..... 5-77
- Interior Lights..... 5-78
  - Interior Lamp AUTO OFF.....5-78
  - Front Lamps.....5-78
  - Rear Lamps .....5-79
  - Vanity Mirror Lamp .....5-79
  - Glove Box Lamp .....5-80
  - Welcome System .....5-80
- Wipers and Washers ..... 5-82
  - Windshield Wipers .....5-82
  - Windshield Washers.....5-84
- Manual Climate Control System ..... 5-85
  - Heating and Air Conditioning.....5-86
  - System Operation.....5-90
  - System Maintenance .....5-91
- Automatic Climate Control System ..... 5-93
  - Automatic Heating and Air Conditioning .....5-94
  - Manual Heating and Air Conditioning .....5-95
  - Multi Air Mode.....5-101
  - System Operation.....5-102
  - System Maintenance .....5-104
- Windshield Defrosting And Defogging.....5-106
  - Manual Climate Control System.....5-106
  - Automatic Climate Control System.....5-107
  - Rear window defroster .....5-108
- Climate Control Additional Features .....5-109
  - Auto Defogging System on Models with Automatic Temperature Control.....5-109
  - Auto Dehumidify .....5-110
  - Recirculating Air when washer fluid is used.....5-111
  - Sunroof Inside Air Recirculation.....5-111
  - Automatic Controls for the Driver Based on Climate Control System Settings.....5-111

## 5. Convenient Features

---

Storage Compartment.....	5-112
Center Console Storage.....	5-112
Glove Box.....	5-113
Storage Box Under the Rear Seat.....	5-113
Luggage Compartment Features .....	5-114
Tonneau Cover.....	5-114
Sidewall Molded in Features .....	5-117
Underbed Storage.....	5-119
Sidewall Side Storage .....	5-121
Tie Down.....	5-122
Rail and cleat system .....	5-123
Interior Features.....	5-124
Cup Holder.....	5-124
Sunvisor .....	5-125
Power Outlet.....	5-125
USB Charger .....	5-126
Wireless Smart Phone Charging System .....	5-127
Clock .....	5-129
Coat Hook.....	5-130
Floor Mat Anchor(s).....	5-130
Exterior Features.....	5-131
Roof Rack .....	5-131
Infotainment System .....	5-132
USB Port.....	5-132
Antenna.....	5-132
Steering Wheel Remote Controls.....	5-133
Infotainment System .....	5-134
Voice Recognition .....	5-134
Bluetooth® Wireless Technology.....	5-134
How Vehicle Radio Works.....	5-135

## ACCESSING YOUR VEHICLE

### Remote Key (if equipped)



Your HYUNDAI uses a remote key, which you can use to lock or unlock the driver and passenger doors or the tailgate.

1. Door Lock
2. Door Unlock
3. Tailgate Open (if equipped)
4. Panic

#### **Locking**

To lock :

1. Close all doors, engine hood and tailgate.
2. Press the Door Lock button (1) on the remote key.
3. The doors will lock. The hazard warning lights will blink.
4. Make sure the doors are locked by pulling the outside door handle.

#### **WARNING**

**Do not leave the Smart Key in your vehicle with children that are unattended or unsupervised.**

**Children could place the key in the ignition switch or could operate the power windows or other vehicle controls or even cause the vehicle to move. This could result in serious injury or death.**

#### **Unlocking**

To unlock:

1. Press the Door Unlock button (2) on the remote key.
2. The doors will unlock. The hazard warning lights will blink two times.
  - Two press unlock setting :  
If you press the door unlock button on the remote key again within four seconds, then all the doors will unlock. Two press unlock setting can be changed according to owner's preference in the cluster User Settings mode.
  - User settings mode method :  
Select or deselect the 'Two Press Unlock' feature in the User Settings mode on the cluster LCD display (User Settings → Door → Two Press Unlock).

#### **Information**

**After unlocking the doors, the doors will lock automatically after 30 seconds unless a door is opened.**



**Opening the tailgate**

Press and hold the The Tailgate Open button (3) for 1 second. The rear lamps will flash and the tailgate will fall with dampening.

**Panic alarm**

The horn sounds and the hazard warning lights blink for about 30 seconds if Panic button (4) is pressed for more than 1 second. To stop the horn and lights, press any button on the transmitter.

***i* Information**

The word “HOLD” is written on the button to inform you that you must press and hold the button for more than one second.

**Start-up**

For detailed information refer to “Key Ignition Switch” in chapter 6.

**NOTICE**

To prevent damaging the remote key:

- Keep the remote key away from liquids or any type of extreme heat. If water or liquid gets inside of the remote or if the remote is subjected to extreme heat, damage to the internal circuit may result. This would void the vehicle warranty.
- Avoid dropping or throwing the remote key.
- Protect the remote key from extreme temperatures.

**Mechanical key (if equipped)**

ONX4OB051002

If the remote key does not operate normally, you can lock or unlock the door by using the mechanical key.

To unfold the key, press the release button then the key will unfold automatically.

To fold the key, fold the key manually while pressing the release button.

**NOTICE**

**Do not fold the key without pressing the release button. This may damage the key.**

**Remote key precautions**

The remote key may not operate under the following conditions :

- The key is in the ignition switch.
- You exceed the operating distance limit (about 32 feet [10 m]).
- The remote key battery is weak.
- Other vehicles or objects may be blocking the signal.
- The weather is extremely cold.
- The remote key is close to a radio transmitter such as a radio station or an airport which can interfere with normal operation of the remote key.

When the remote key does not work correctly, unlock and lock the door with the mechanical key. If you have a problem with the remote key, contact an authorized HYUNDAI dealer.

If the remote key is in close proximity to your mobile phone, the signal could be blocked by your mobile phone's normal operational signals.

This is especially important when the phone is active such as making and receiving calls, text messaging, and/or sending/receiving emails.

Avoid placing the remote key and your mobile phone in the same location and always try to maintain an adequate distance between the two devices.

### Information

This device complies with Part 15 of the FCC rules.

Operation is subject to the following three conditions:

1. This device may not cause harmful interference.
2. This device must accept any interference received, including interference that may cause undesired operation.
3. Changes or modifications not expressly approved by the party responsible for compliance could void the user's authority to operate the device.

### **NOTICE**

Keep the remote key away from electromagnetic materials that block electromagnetic waves to the key surface.

### **Battery replacement**



OPD046002

Battery Type: CR2032

1. Insert a slim tool into the slot and gently pry open the cover.
2. Remove the old battery and insert the new battery. Make sure the battery position is correct.
3. Reinstall the rear cover of the remote key.

If you suspect your remote key might have sustained some damage, or you feel your remote key is not working correctly, contact an authorized HYUNDAI dealer.

### Information



An inappropriately disposed battery can be harmful to the environment and human health. Dispose of the battery according to your local law(s) and regulation.

### Smart Key (if equipped)



Your HYUNDAI maybe equipped with a smart key, which you can use to lock or unlock the doors and tailgate, and start the engine while just having the key in your possession.

1. Door lock
2. Door unlock
3. Tailgate Open
4. Panic
5. Remote start

### Locking your vehicle (Button type)

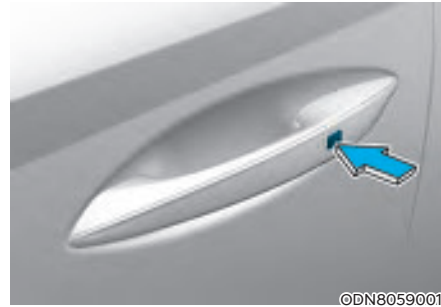

To lock :

1. Close all doors, engine hood and tailgate.
2. Carry the smart key.
3. Either press the door handle button or press the Door Lock button (1) on the smart key.
4. The hazard warning lights will blink and the chime will sound once.
5. Make sure the doors are locked by pulling the outside door handle.

**Locking your vehicle (Touch sensor type) (if equipped)**

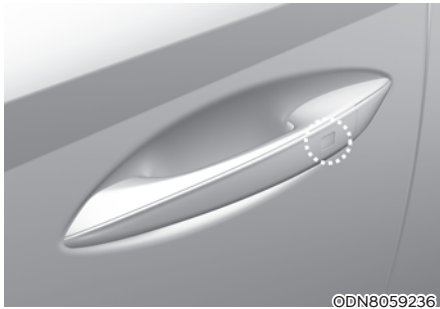

1. Make sure that all doors are closed.
2. While having the Smart Key in your possession, touch the outer part of the door handle on or near the handle detent for about 1 second or until you hear the door locks actuate.
3. The doors will be locked. If the tailgate was open, then when the tailgate is closed it will be locked also.

The chime will sound once and the hazard warning lights will blink.

- The door handle button will only operate when the smart key is within 28-40 inches (0.7-1 m) from the outside door handle.
- Make sure the doors are locked by pulling the door handle. If you locked the door with the touch sensor on the door handle, the doors cannot be unlocked with the sensor within 3 seconds.

Note that if you press the outside door handle to lock the doors using the touch sensor, the doors will not lock under the following circumstances:

- The Smart Key is in the vehicle
- The Engine Start/Stop button is in the ACC or ON position
- Any of the doors are open (except for the tailgate)

If this occurs, then a chime will sound for about 3 seconds. Check the vehicle before attempting to lock the car again.



**CAUTION**

**Before you leave your vehicle with the Smart Key, verify that your vehicle is locked. When using the touch sensor on the front door handle, listen to hear that the lock has actuated, and then pull the handle within 3 seconds to confirm the doors are locked.**

**(if it has been longer than 3 seconds, verify the doors are locked by pressing the lock button on the Smart Key. You will hear a single beep.)**



**WARNING**

**Do not leave the Smart Key in your vehicle with children that are unattended or unsupervised.**

**Children could inadvertently press the Engine Start/Stop button or could operate the power windows or other vehicle controls or even cause the vehicle to move. This could result in serious injury or death.**

### Unlocking your vehicle(When the Two Press Unlock feature is off)

#### ■ Button type

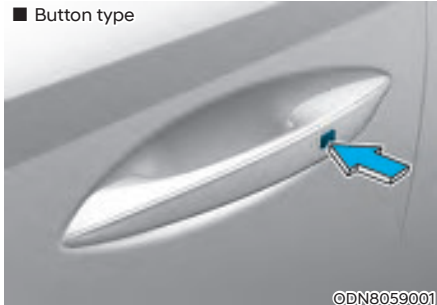

©DN8059001

#### ■ Touch sensor type

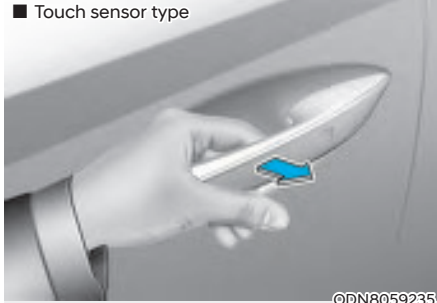

©DN8059235

1. Make sure you have the smart key in your possession.
2. Press the Door Unlock button (2) on the smart key, press the button on the front door handle or touch the door unlock sensor inside of the front door handle to unlock the doors.
3. All of the doors will unlock. When the doors unlock, the hazard warning lights will blink two times.
  - The door handle button will only operate when the smart key is within 28-40 inches (0.7-1 m) from the outside door handle.
  - If you do not open the door after unlocking within 30 seconds, it will return to the lock mode.
  - If you unlocked the door with the door handle, the doors cannot be locked with the sensor for up to 2 seconds.

### Unlocking your vehicle(When the Two Press Unlock feature is on)

1. Make sure you have the smart key in your possession.
2. Press the Door Unlock button (2) on the smart key, press the button on the front door handle or touch the door unlock sensor inside of the front door handle to unlock the doors.
3. The driver's door will unlock.
4. If you press the button on the front door handle or touch the door unlock sensor inside of the front door handle to unlock the doors within 4 seconds, all of the doors unlock. When the doors unlock, the hazard warning lights will blink two times.
  - The door handle button will only operate when the smart key is within 28-40 inches (0.7-1 m) from the outside door handle.
  - If you do not open the door after unlocking within 30 seconds, it will return to the lock mode.
  - The factory default setting is in off mode so you should set in the User's Settings mode.
  - If you unlocked the door with the door handle, the doors cannot be locked with the sensor for up to 2 seconds.

### *Two Press Unlock Feature*

The priority for unlocking the driver door only, or unlocking all the doors with one press may be adjusted in the User Settings mode in the cluster LCD display.

The Two Press Unlock feature, when enabled, will require the user to press the door unlock button once for driver door only and twice for unlocking all the doors.

Select or Deselect the Two Press Unlock feature in the User Settings mode in the cluster LCD display. The option can be found under the following menu:

User Settings → Door → Two Press Unlock

The Two Press Unlock feature can also be enabled or disabled by pressing the door lock and unlock buttons simultaneously on the Key FOB:

Press and hold both the Door Lock button and the Door Unlock button simultaneously until the hazard warning lights blink.

This will enable or disable the Two Press Unlock feature. Repeat this procedure to enable/disable the mode again.

### **Opening or Unlocking the Tailgate**

To open the tailgate:

1. If your vehicle has a Smart Key, make sure you have the Smart Key in your possession.
2. Press either the tailgate open/close button on the vehicle or press and hold the tailgate open button on the smart key for more than one second. The hazard warning lights will blink twice and the tailgate will be unlocked. Press the tailgate release button to open the tailgate.

### **Remotely starting vehicle (if equipped)**

You can start the vehicle using the Remote Start button on the smart key.

To start the vehicle remotely:

1. Before you can use remote start your vehicle, the door lock button must be pressed. Press the door lock button on the Smart Key. You must be within about 32 feet (10m) from your vehicle.
2. Press and hold the remote start button on your Smart Key. You must press the button within 4 seconds from when you pressed the door lock button to activate the remote start.
3. The hazard warning lights will blink and the engine will start.
4. To turn off the remote start function, press the Remote Start button once.

**i** Information

- The vehicle must be in P (Park) for the remote start function to start.
- If the engine is started using the remote start function, the engine will turn off if you enter the vehicle without having the smart key in your possession.
- The engine turns off if you do not get on the vehicle within 10 minutes after remotely starting the vehicle.
- The Remote Start button may not operate if the smart key is not within 32 feet (10 m).
- All doors must be locked and the hood must be closed in order for the remote start to operate.
- Do not idle the engine for a long period.

**Panic alarm**

The horn sounds and the hazard warning lights blink for about 30 seconds if this button is pressed for more than 1 second. To stop the horn and lights, press any button on the transmitter.

**Push Button Start/Stop (if equipped)**

Some models are equipped with a push button start instead of a key cylinder. You can leave your Smart Key in your pocket or purse when you start your vehicle.

For more details, refer to the “Engine Start/Stop Button” section in chapter 6.

**i** Information

If the smart key is not moved for some time, the detection function for smart key operation will pause. Lift the smart key to activate the detection again.

**NOTICE**

To prevent damaging the smart key:

- Keep the smart key in a cool, dry place to avoid damage or malfunction. Exposure to moisture or high temperature may cause the internal circuit of the smart key to malfunction which may not be covered under warranty.
- Avoid dropping or throwing the smart key.
- Protect the smart key from extreme temperatures.

### **Mechanical key**

If the Smart Key does not operate normally, you can lock or unlock the driver's door by using the mechanical key.

To remove the mechanical key from the smart key FOB:



OFE048007

Press and hold the release button (1) and remove the mechanical key (2). Insert the mechanical key into the key hole on the door.

### **Key Cylinder (Driver Door)**

A key cylinder is located on the driver side door handle hidden behind a plastic cover. Using the mechanical key, push and hold the key cylinder cover release button located on the underside of the door handle.

Use the mechanical key inserted into the release button slot to pry the cover outward. Once the cover is off, the mechanical key can be inserted into the key cylinder to lock or unlock the vehicle.

To reinstall the mechanical key into the key FOB, put the key into the key FOB hole and push inward until a click sound is heard.

### **Loss of a smart key**

A maximum of two smart keys can be registered to a single vehicle. If you happen to lose your smart key, you should immediately take the vehicle and remaining key to your authorized HYUNDAI dealer or tow the vehicle, if necessary.

### **Smart key precautions**

The smart key may not work if any of the following occur:

- The smart key is close to a radio transmitter such as a radio station or an airport which can interfere with normal operation of the transmitter.
- The smart key is near a mobile two way radio system or a mobile phone.
- Another vehicle's smart key is being operated close to your vehicle.
- The vehicle battery is discharged.

If the smart key does not work correctly, open and close the door with the mechanical key. If you have a problem with the smart key, contact an authorized HYUNDAI dealer.

If the smart key is in close proximity to your mobile phone, the signal could be blocked by your mobile phone's normal operational signals. This is specifically relevant when the phone is active such as making and receiving calls, text messaging, and/or sending/receiving emails. When possible, avoid keeping the smart key and your mobile phone in the same location such as a pants or jacket pocket in order to avoid interference between the two devices.



### **i** Information

This device complies with Part 15 of the FCC rules.

Operation is subject to the following three conditions:

1. This device may not cause harmful interference.
2. This device must accept any interference received, including interference that may cause undesired operation.
3. Changes or modifications not expressly approved by the party responsible for compliance could void the user's authority to operate the device.

### **NOTICE**

- Keep the smart key away from electromagnetic materials that blocks electromagnetic waves to the key surface.
- Always have the smart key with you when leaving the vehicle. If the smart key is left near the vehicle, the vehicle battery may be discharged.

### **Battery replacement**

If the Smart Key is not working properly, try replacing the battery with a new one.

Battery Type: CR2032

To replace the battery:



Battery Type: CR2032

To replace the battery:

1. Remove the mechanical key.
2. Use a slim tool or utility blade to pry open the cover of the smart key. Use caution not to damage the smart key.
3. Remove the old battery and insert the new battery. Make sure the battery position is correct.
4. Reinstall the rear cover of the smart key.

If you suspect your smart key might have sustained some damage, or you feel your smart key is not working correctly, contact an authorized HYUNDAI dealer.

### **i** Information



An inappropriately disposed battery can be harmful to the environment and human health. Dispose of the battery according to your local law(s) or regulations.

### Immobilizer System

The immobilizer system helps protect your vehicle from theft. If an improperly coded key (or other device) is used, the engine's fuel system is disabled.

When the ignition switch is turned on (or the Engine Start/Stop button is pressed to the on position), the immobilizer system indicator should come on briefly, then go off. If the indicator starts to blink, the system does not recognize the coding of the key.

Turn the ignition switch to the Lock position, then turn the ignition switch to the ON position again. (For remote key)

Press the Engine Start/Stop button to the OFF position, then press the Engine Start/Stop button to the ON position again. (For smart key)

The system may not recognize your key's coding if another immobilizer key or other metal object (for example, key chain) is near the key. The engine may not start because the metal may interrupt the transponder signal from transmitting normally.

If the system repeatedly does not recognize the coding of the key, contact your HYUNDAI dealer.

Do not attempt to alter this system or add other devices to it. Electrical problems could result that may make your vehicle inoperable.

### WARNING

**In order to prevent theft of your vehicle, do not leave spare keys anywhere in your vehicle. Your immobilizer password is a customer unique password and should be kept confidential.**

### **NOTICE**

**The transponder in your key is an important part of the immobilizer system. It is designed to give years of trouble-free service, however you should avoid exposure to moisture, static electricity and rough handling. Immobilizer system malfunction could occur.**

### Information

**This device complies with Part 15 of the FCC rules.**

**Operation is subject to the following three conditions:**

- 1. This device may not cause harmful interference.**
- 2. This device must accept any interference received, including interference that may cause undesired operation.**
- 3. Changes or modifications not expressly approved by the party responsible for compliance could void the user's authority to operate the device.**

## HYUNDAI DIGITAL KEY (IF EQUIPPED)

### **Digital Key Application**

To use Hyundai Digital Key mobile app, you should install the Hyundai Digital Key app on your Android phone. Search 'Hyundai digital key' in the Google Play Store and download the app. Please refer to the detailed manual of the digital key app. The option can be found under the following app menu:

#### **Menu → Application Info → Tutorial**

Please review the contents of the manual before using the app.

- \* This service is only available for Android smartphones. Please confirm supported/compatible devices on our website.



### **WARNING**

#### **Delete Digital Key Settings When Purchasing a Used Vehicle**

**If any of the digital key (smartphone key or card key) is already registered when you press ON button after unlocking the doors, the message 'Digital key(s) active' appears on the instrument cluster once. If you sell your vehicle or purchase a used Hyundai vehicle equipped with the Digital Key feature, you should confirm the message and delete the registered smartphone key and card key. For more information, please contact the Hyundai Customer Care Center. If the card key does not work properly, please delete the card key and register the smartphone key and re-register the card key.**

### **For vehicle maintenance**

If you need to have your Digital Key System repaired or replaced please ensure your Smartphone Key is still active. You may have to pair your phone again.

In some instances you may have to re-initialize your Digital Keys using the Hyundai Digital Key mobile app.

### **Digital key (smartphone) NFC function**

In order to use the Digital Key feature on your Android smartphone, you must first enable the NFC (Near Field Communication) setting on your phone.

To enable NFC, go to Settings on your smartphone.

In addition, your smartphone screen should be unlocked when using the Digital Key feature.

- \* To enable the user settings for NFC on your smartphone, go to the Settings app on your phone. For further assistance, refer to your smartphone manual.

### Digital key (smartphone)

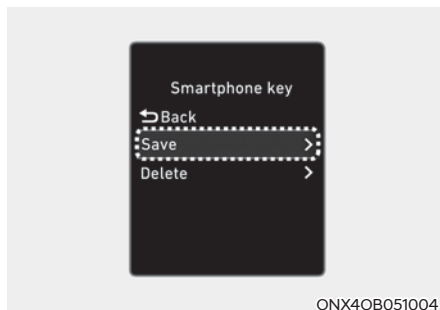
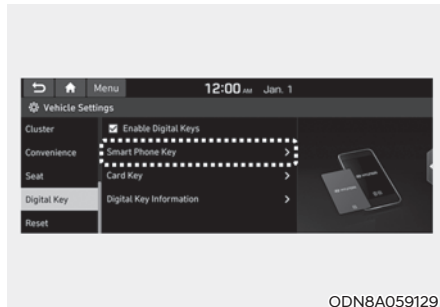

#### Hyundai Digital Key (Smartphone) Pairing

1. Turn the vehicle on with the Smart key and make sure to keep the smart key inside the vehicle during digital key registration.
2. Select the vehicle to save on your Digital key application and activate the save mode.
  - \* Save mode is available only on the vehicle owner's Digital key application.
3. Place your smartphone on the wireless charging pad. The charging pad also functions as a vehicle authentication pad. The vehicle will recognize the smartphone within a few seconds.

### **i** Information

The [Save] button will be disabled if the digital key (Smartphone key) is already saved.

Please refer to “Digital Key Delete” in this manual and follow the digital key delete procedure in your car before Digital key save.

Please refer to the ‘Tutorial’ on your Digital key app and delete the previous saved key in your smartphone before save.

4. Register your Digital key from the vehicle user setting menu as follows.
  - \* With Navigation screen :  
From the infotainment screen menu, go to [Setup] - [Vehicle] - [Digital Key] - [Smart Phone Key] then select the [Save] from submenu.
  - \* Without navigation screen :  
From cluster menu, go to [Digital Key] - [Smart Phone Key] and select [Save].
5. Once the digital key save is complete, a message will be shown on the infotainment screen or cluster.
6. Remove the smartphone from the pad and complete the saving process.



[A] : Wireless Charging Pad (In-vehicle Authentication Pad)

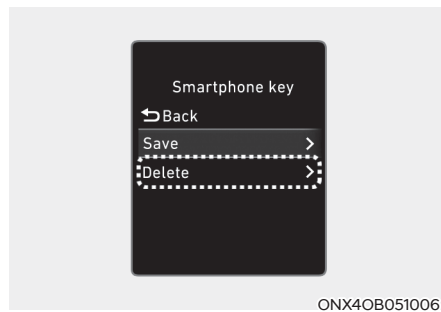
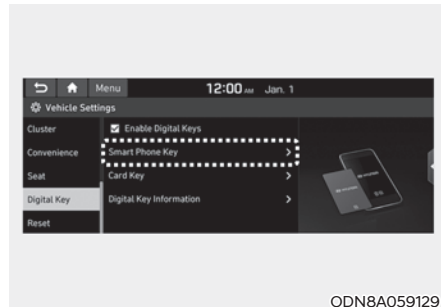

### Hyundai Digital Key (Smartphone Key) Deletion

1. Turn the vehicle on with the Smart key and make sure to keep the smart key inside the vehicle during delete process.
2. Delete your Digital key from the vehicle user setting menu as follows.
  - \* With Navigation screen :  
From the infotainment screen menu, go to [Setup] - [Vehicle] - [Digital Key] - [Smart Phone Key] then select the [Delete] from submenu.
  - \* Without navigation screen :  
From cluster menu, go to [Digital Key] - [Smart Phone Key] and select [Delete].

### **i** Information

The [Delete] button will be disabled if there is no digital key (Smartphone key) saved.

3. Once the digital key delete is complete, a message will be shown on the infotainment screen or cluster.
4. Go to [Initialize Digital Key] menu on the digital key application and select the vehicle to delete the digital key information.
  - Open the Hyundai Digital Key app → Menu → Initialize Digital Key
  - \* If the saved digital key information in your car is deleted due to vehicle maintenance, the digital key in your smartphone should be deleted as well.
  - \* For more information, please refer to the 'Tutorial' on your Digital key app.

### **!** CAUTION

- If the smartphone is removed from the interior authentication pad during enrollment, the saving process will be cancelled.
- If the infotainment or instrument cluster screen is changed during enrollment, the saving process will be cancelled.
- If the vehicle is turned off during enrollment, the saving process will be cancelled.
- If the gear is shifted, the saving process will be cancelled.
- If you try to save the smartphone which is not logged in with the vehicle owner's ID or if you try to save the Card key, the saving process will not begin.
- If the NFC setting on your smartphone is off, the saving process will not begin.
- If the smartphone screen is changed to off or locked status, the saving process will be cancelled.
- If there is no Smart key during the save process, the saving process will not begin.

### Set up main vehicle

You can manage multiple digital keys from the Digital key app. From the list of digital keys you own, select the vehicle you want to make your priority vehicle.

**For more information, please refer to the 'Tutorial' on your Digital key app.**



[A] : Door handle authentication pad,  
[B]: NFC Antenna

### NFC door lock/unlock

To unlock your vehicle using the smartphone Digital Key, position your phone near the door handle NFC touch sensor of either the driver side or passenger side door. Hold your phone near the touch sensor area for about 2 seconds. You will hear the doors lock or unlock.

If you unlock your vehicle from the passenger side door handle, then all the doors will unlock. If you unlock your vehicle from the driver side door handle, then either the driver door only or all the doors will unlock depending on the setting of the Two Press Unlock feature. Refer to User Settings to change the Driver Door unlock mode.

To lock your vehicle using the smartphone Digital Key, position your phone near the door handle NFC touch sensor of either the driver side or passenger side door.

Before you leave your vehicle, verify that your vehicle is locked. When using your smartphone Digital Key on the front door handle, listen to hear that the door lock has actuated, and then pull the handle within 3 seconds to confirm the doors are locked.

Note that you will not be able to lock your vehicle using your smartphone Digital Key under the following circumstances:

- The Proximity / Smart Key is in the vehicle.
- The POWER button is in ACC or ON position.
- Any of the doors, hood and trunk is opened.
- The vehicle battery is discharged

If the smartphone Digital Key does not work properly, try again by removing the smartphone away from the door handle (more than 4 inches) and try it again.

Note that when the doors have been unlocked using the smartphone Digital Key, the Lock/Unlock switch on the driver door may not be immediately available.

(If you attempt to lock the doors using the driver door lock switch, the doors will lock and then immediately unlock when you close the door.)

### Start-up with Digital Key

1. After placing your registered smartphone onto the authentication pad (same location as the wireless charging pad), step on the brake and press the Engine Start/Stop button.
2. After the engine has started, you can remove your smartphone from the authentication pad. If you would like to charge your phone using the wireless charger, leave your phone on the pad. Wireless charging should begin automatically after about 5 to 20 seconds. Note that all the doors must be closed before to enable the wireless charging feature.



[A] : Wireless Charging Pad (In-vehicle Authentication Pad)

### **i** Information

After reconnecting the vehicle battery power supply or charging the battery, it may take time to operate due to remote renewal of security information. In this case, when you lock or unlock the doors using your smartphone Digital Key, it may take a little longer for the vehicle to authenticate. Hold your smartphone near the NFC door handle sensor for a few seconds or until you hear the door locks actuate.

**Note that if your vehicle is parked in an area where cell coverage is weak, the smartphone Digital Key can still be used on for a limited number of times to unlock and start your vehicle.**

**After starting your vehicle, to leave your smartphone on the wireless charging pad until cell phone service is stronger and digital key authentication can occur.**

**Once authentication is complete, the wireless charger will turn on (wireless charging LED will illuminate).**

### **⚠ CAUTION**

**The engine can be turned on if the registered smartphone or card key is placed on the interior authentication pad (wireless charger). Do not leave children unattended in the vehicle when using the smartphone Digital Key. Serious injury or death can occur.**

**Do not leave anyone in the vehicle without knowledge of the Digital Key system when using the smartphone Digital Key. Always have the registered digital key (smartphone) or card key with you to prevent vehicle theft when leaving the vehicle.**

**For more information, refer to the Engine Start/Stop button in chapter 6.**

### Remote Features from Your Smartphone with the Digital Key App

To use the remote features from your smartphone with the Digital Key app, make sure Bluetooth is enabled.

#### *Connecting Your Vehicle with Digital Key*

1. Open the Hyundai Digital Key app on your smartphone and select your vehicle within the app.
2. Approach your vehicle with your smartphone in hand. Be sure that your phone is unlocked and the app is running. If your vehicle does not automatically connect, you can press the connect button on the app. Remote features on the Digital Key app will be available as soon as your vehicle is connected.

#### *Remote Features Using Digital Key*

You can perform several vehicle functions using the Digital Key app, including door lock/unlock, panic ON/OFF, remote engine start/stop and opening the tailgate. The icon for each function is shown in the Digital Key app, and will be highlighted when the operation is performed. Haptic feedback from your phone will occur when the icon is selected.

Note that you cannot lock your vehicle using the Hyundai digital key app if any of the following occurs:

- The POWER button is in ACC or ON position.
- Any doors are open.

When the smartphone and the vehicle are connected by the Bluetooth function but the remote control command cannot be received over 5 minutes, the remote control connection is cancelled automatically.



### CAUTION

- If metallic window tint was applied to your vehicle, it may cause bad Bluetooth connection or performance degradation of the digital key.
- If multiple users operate the remote control function simultaneously, the connection between the digital key and the vehicle might result in failed commands. Please connect and operate the remote control function only the necessary user.
- When using the remote control operation, the driver (the remote control user) should leave the vehicle after confirming the door lock (the chime sounds once and the hazard warning lights blink).
- The remote functions of the Digital Key app enables the vehicle to be controlled from a set distance. If the digital key or the vehicle goes beyond the operable distance, the remote control function might be disconnected or cancelled.
- If the digital key (smartphone) is connected with the vehicle for the remote control, the driver with the key goes far away from the vehicle, the function might not work.
- If the remote control operation is executed where the mobile connection is weak, Bluetooth connection is poor due to several Bluetooth devices or there is an object such as metal or concrete, it might be delayed or the operable distance might decrease. You should not cover the smartphone with your hand or place other devices which can cause frequency interference. It may result in poor performance.
- If the remote control function is not available, please use NFC function to lock or unlock the doors.



#### *Remote Start with Digital Key*

- Using the Hyundai Digital Key app on your phone, press the Door Lock button and then press the Remote Start button (buttons must be pressed within about 4 seconds). If all the doors of your vehicle are closed (including the hood and the tailgate), the engine will be automatically started.

Note that when the remote start feature is activated, the hazard warning lights will blink two times and a chime will sound before engine startup. Also note the following:

- The climate control system will come on using the same settings from when you last used the vehicle
- To turn off the engine, press the Remote Engine Stop button within the Hyundai Digital Key app.
- The engine will remain running for approximately 10 minutes, and then engine will automatically shut OFF.
- To keep the engine running, access the vehicle and place the smartphone on the wireless charging pad (authentication pad) while the engine is still in remote engine-ON mode.

**For more information, refer to the Engine Start/Stop button in chapter 6.**

#### *Vehicle information Display*

The digital key application displays the vehicle information such as driving or door conditions through the communication with the vehicle.

- How to check : Select the vehicle what you want to check and touch the vehicle image, then vehicle information display page will be shown.
- Contents : accumulated odometer, latest fuel economy, driving range, fuel remaining, tire pressure, doors lock/unlock status and last data updated time.
- \* Note that displayed vehicle data may be slightly different from the current vehicle condition
- \* **For more information, please refer to the 'Tutorial' on your Digital key app.**

### Getting a new smartphone / Changing your smartphone / App deletion

If you change your smartphone or delete the Hyundai Digital Key App, please refer to the following to set up your Digital Key:

#### *Using Digital Key on a New Smartphone*

If you change to a new smartphone, the registered digital key app on your previous smartphone may not be used. Refer to the following procedure to set up digital key on your new phone.

1. Install the digital key application and log in.
2. If you are the owner, retry the Digital key save process.
3. If you are using a shared digital key, you will need to obtain a new shared digital key from the owner.

#### *App delete & reinstall/ Delete App data*

You can re-download the digital key from server in these cases as follow procedure.

1. Reinstall the application and log in.
2. Input the PIN number for user verification.
3. If PIN is correct, digital key data will be re-downloaded to your smartphone and you can use it without any further registration or sharing.

#### *Smartphone operability with Digital Key*

The digital key application may not be available to old type smartphones. Please check the available smartphone models with your dealer. NFC antenna position on the smartphone can be confirmed on each smartphone's manual or contact to customer service center of the smartphone manufacture.



### CAUTION

- Do not leave the registered digital key (smartphone) and card key in your vehicle. Please carry around your keys all the times.
- If you happen to lose your digital key (smartphone) or card key registered as a main user's key, you should immediately delete the key on the vehicle's key menu. For more information, refer to the Digital Key Deletion in this chapter.
- If you registered your digital key (smartphone) or card key in the vehicle, a message appears on the instrument cluster and let you know the key is registered. (Message: Digital key(s) active.)
- If you buy a used vehicle, you should confirm the message and delete the registered smartphone key and card key. In this case, you should carry your smart key.
- If you keep place the NFC card of the digital key on the interior authentication pad (wireless charger) while driving, it may cause a malfunction of the NFC card.
- You should remove your NFC card of the digital key on the interior authentication pad after turning on the engine.

- Hyundai digital key app may not work properly when the NFC or Bluetooth communication between smartphone and car is not good.
- If the remote control operation is executed where the mobile connection is weak, Bluetooth connection is poor due to lots of Bluetooth devices or there is an object such as metal or concrete, it might be delayed or the operable distance might decrease. Especially, you should not cover the smartphone with your hand or place other devices which can cause frequency interference. It may result in poor performance.
- If the remote control function is not activated, please use NFC function to lock or unlock the doors
- You should be careful not to press the remote control button on the digital key (smartphone) accidentally.
- If the digital key (smartphone) is discharged or defective or you cannot use the digital key since the vehicle battery is discharged, use the inside door lock button to lock all of the doors.



#### CAUTION

- Hyundai digital key app on the smartphone and card key may not work if any of the following occurs:
  - Hyundai digital key app on the smartphone is deleted. (Required to reinstall the app)
  - Account log in information of Hyundai digital key app is expired. (Required to re-log in)
  - When you try to log in to another smartphone instead of the registered smartphone with same user account.
  - Smartphone rooting or app hacking is detected.
  - Smartphone battery or the vehicle battery is discharged.
  - Smartphone's screen is off or locked.
  - NFC or Bluetooth is turned off on the smartphone settings.
  - Smartphone's mobile network setting is off or airplane mode is activated.
  - A credit card is overlapped in the back of your smartphone or metal or thick case is used.
  - Use the card key with insert it into the wallet or card holder or overlapping with other cards.
  - If you use a smart phone cover that uses wireless communication or is made of metal, the digital key NFC function may not work properly. Remove the smart phone cover before using the digital key NFC function.

- The vehicle may not be controlled by the smartphone if any of the following occurs:
  - Basic and necessary functions of the smartphone manufacturer are operating. (General call, urgent call, audio or NFC payment)
  - Wireless earphone is operating. (General call, urgent call or audio)
  - The digital key app function such as basic setting or app launching is limited by prior policy according to the manufacturer while using a smartphone produced by domestic and foreign manufactures.
- \* If you change the smartphone number, you should modify the user account information on the HYUNDAI customer web site to use the digital key app.
- \* If the vehicle owner changes the smartphone device, the new smartphone should be registered in the car after deleting the registered digital key (smartphone).
- \* If a sharer changes or reset the smartphone, the key should be re-shared from owner.
- \* Some of the old smartphone may not work properly. Please check the available smartphone models with your dealer.
- \* NFC antenna position on the smartphone can be confirmed on each smartphone's manual or contact to customer service center of the smartphone manufacture.

### Digital Key Card Key (Optional feature)

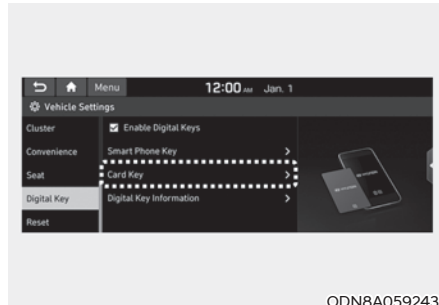

ODN8A059243



ODN8A059131

#### Digital key (Card key) save

1. Install Hyundai digital key app in main user's smartphone and register the digital key (smartphone). Please refer to the registration method of the digital key (smartphone).
  2. Using the [Pair Card Key] menu on the digital key application, you can activate the Card Key registration mode.
- \* NFC authentication : enter the NFC authentication menu and contact the smartphone on the outside door handle.
  - \* Bluetooth authentication : enter the Bluetooth authentication menu and press the [OK] button for activation.
- If you activate the registration mode, you should complete the Card saving process within 5 minutes.

- \* If you have not registered the digital key (smartphone), please register the digital key (card key) with two smart keys.
- 3. Place the NFC card key onto the interior authentication pad (wireless charger). The saving process will begin automatically.
- 4. Register the NFC card key on the User's Settings menu after turning on the vehicle.
  - \* With Navigation screen : From the infotainment screen menu, go to [Setup] - [Vehicle] - [Digital Key] - [Card Key] then select the [Save] from submenu.
  - \* Without navigation screen : From cluster menu, go to [Digital Key] - [Card Key] and select [Save].

The [Save] button will be disabled if the digital key (Card key) is already saved.

Please refer to "Digital Key Delete" in this manual and follow the digital key delete procedure in your car before Digital key save.
- 5. If the key is enrolled, the message will be displayed on the infotainment screen or instrument cluster.

### **i** Information

- **Once the card key registration mode is activated, the process should be completed within 5 minutes. After then, you should reactivate once again for registration.**
- **For the digital key(card key) saving, the smart key(fob) must be exist inside of vehicle.**
- **Once a Card key is registered, it cannot be reuse onto another vehicle.**

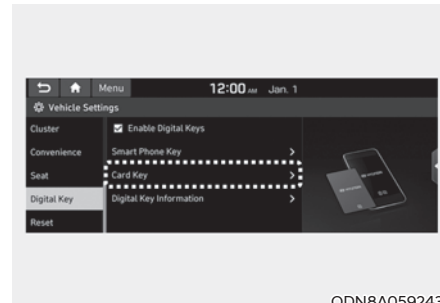

ODN8A059243



ODN8A059132

### Digital key (Card key) deletion

Note that the remote Smart Key must be in your possession and inside the vehicle in order to delete the Digital Key Card.

1. Access the vehicle using the Smart Key.
2. Start the vehicle and then access the Digital Key Card Key functions in the User Settings menu in either the LCD display or from the Navigation infotainment screen (on some models.)
  - \* With Navigation screen : From the infotainment screen menu, go to [Setup] - [Vehicle] - [Digital Key] - [Card Key] then select the [Delete] from submenu.
  - \* Without navigation screen : From cluster menu, go to [Digital Key] - [Card Key] and select [Delete].

If there is no saved digital key(card key), [Delete] menu will not be activated.

## Convenient Features

---

- To delete the saved digital key card, you must have the Smart Key in your possession and be inside the vehicle
- Note that if the digital key card is deleted, it can be re-registered to the same vehicle as long as a new card has not already been registered
- If you try to register a new digital key card, the previously registered card will no longer be active and cannot be re-registered

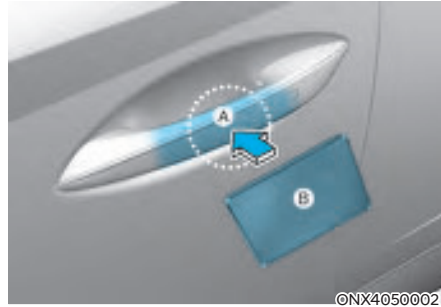

[A] : Door handle authentication pad,  
[B]: NFC Antenna

### NFC door lock/unlock

To unlock your vehicle using the NFC card key, touch the card key near the door handle NFC touch sensor of either the driver side or passenger side door. Hold the card key near the touch sensor area for about 2 seconds. You will hear the doors lock or unlock.

If you unlock your vehicle from the passenger side door handle, then all the doors will unlock. If you unlock your vehicle from the driver side door handle, then either the driver door only or all the doors will unlock depending on the setting of the Two Press Unlock feature. Refer to User Settings to change the Driver Door unlock mode.

To lock your vehicle using the NFC card key, touch the card key near the door handle NFC touch sensor of either the driver side or passenger side door.

Before you leave your vehicle, verify that your vehicle is locked. When using your NFC card key on the front door handle, listen to hear that the door lock has actuated, and then pull the handle within 3 seconds to confirm the doors are locked.

*Inoperable condition*

When using the NFC card key to lock or unlock your vehicle, be sure to touch the card key near the center of the door handle to enable the sensor to activate.

Note that you must take the card out of your wallet or purse to use the card key correctly. If the card key is not touching the door handle sensor or is in close proximity to other NFC-enabled cards, it may not work.

Note that if you attempt to use the NFC card key to lock the doors, the doors will not lock under the following circumstances:

- The Smart Key is in the vehicle
- The Engine Start/Stop button is in the ACC or ON position
- Any of the doors are open (except for the tailgate)

If this occurs, then a chime will sound for about 3 seconds. Check the vehicle before attempting to lock the car again.

If you have difficulty locking or unlocking the vehicle using the NFC card key, remove the card key away from the door handle sensor for a few seconds (card key must be more than 4 inches away) and then retry.

If the card key is damaged or bent, the sensor on the door handle may not properly detect the card key. If this occurs contact your authorized Hyundai dealer for a card key replacement.

Be careful not to damage the card key or expose the card key to extreme temperatures or direct sunlight for long periods of time.

Note that when the doors have been unlocked using the NFC digital card key, the Lock/Unlock switch on the driver door may not be immediately available.

(If you attempt to lock the doors using the driver door lock switch, the doors will lock and then immediately unlock when you close the door.)

**Start-up with Card key**

After placing your registered card key onto the interior authentication pad (wireless charger), step on the brake and press the Engine Start/Stop button.

**WARNING**

- **If you do not place the digital key (card key) onto the center of the interior authentication pad (wireless charger) exactly, the card key may not be recognized. If the engine is not turned on, adjust and place the key again.**
- **If you overlap and use the key with NFC-enabled cards such as transportation card or credit card, the card key may not be recognized.**
- **If the digital key (card key) does not work, please detach the key around 4 inches (0.1 m) from the handle authentication pad and retry to contact.**
- **The card key may be damaged due to impact. It would not work properly if the key is damaged. You should buy a new card and register again.**

**For more information, refer to the Engine Start/Stop button in chapter 6.**

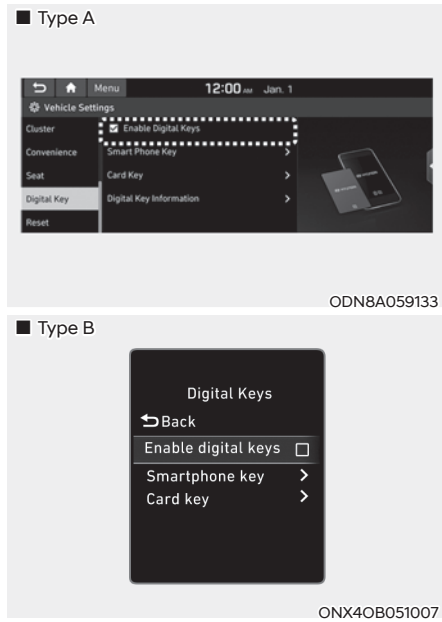

### Enabling or disabling the digital key feature

If you want to temporarily disable the digital key feature (smartphone app and NFC card key), you can do so in the user settings menu.

- \* With Navigation screen :  
From the infotainment screen menu, go to [Setup] - [Vehicle] - [Digital Key] - [Enable Digital Keys] (deselect)
- \* Without navigation screen :  
From cluster menu, go to [Digital Key] - [Enable Digital Keys] (deselect)

### **i** Information

**In order to disable the digital key feature in the user settings menu, you must have the smart key in your possession inside the car.**

### **⚠** CAUTION

If you uncheck **Enable digital keys**, it is impossible to lock or unlock the doors or start up the vehicle with digital keys such as smartphone and card key. If you check **Enable digital keys** again, the registered digital keys (smartphone and card key) are available. Even though you stop the digital key function, the registered keys (smartphone and card key) are not deleted.

### **Personalized profile and vehicle settings**

You have the ability to set the registered digital key with one of two personalized profiles. Then, when you use the digital card key or the Digital Key App, the vehicle will be set to the user-defined personalized profile (which includes such items as driver settings, audio preferences, etc.).

There are two profile connections and personalization settings available for Driver 1 and Driver 2.



### Connecting a profile to your digital key app

#### Linking a Profile

1. Select Setup → User Profile → Profile Settings → Link Digital Key on the infotainment screen menu.
2. Make sure your smartphone is unlocked. Place your smartphone on the wireless charger authentication pad. Once your smartphone is detected the profile link process will be enabled.
3. A pop-up message will be displayed on the screen requesting if you would like to link the user profile to your digital key smartphone.
4. If you select link, the digital key smartphone and the user profile will be linked.
5. A message will be displayed confirming the link process.

#### Unlinking your profile

Select Digital Key Information from the Vehicle Settings menu on the infotainment screen. If a profile is linked, you'll see an option to unlink your profile.

### Information

**If you connect both Driver 1 and Driver 2 with a single smartphone, the smartphone digital key always works as Driver 1.**

**If you unlink the Driver 1, personalization function will operate as Driver 2.**

#### Linking Profiles - Some Tips when you link or unlink a profile to your digital key, note the following:

- Linking a profile with your digital key must be enabled in the user settings menu.
- The profile link information remains even if you disable the digital key feature in the user settings menu.
- The profile link feature works only when the smartphone and the digital key app are already registered to the vehicle.
- While performing the user profile link process to your smartphone digital key, if you remove the smartphone from the authentication pad before the process is complete, the profile link will be cancelled.
- To unlink the profile, the smart phone does not need to be on the wireless charger.

**Vehicle personalization operation**

The personalization function linked with digital key works as following conditions:

- Contact the driver’s door handle with the profile linked smart phone to lock or unlock the doors (Personalization does not operate when locking or unlocking the front passenger door.)
- Remote door unlock with the profile linked smartphone digital key app.

The profile linked with digital key can be changed manually in the infotainment system setup screen.

**Precaution for digital key profile link and unlink**

Profile operation according to door lock/unlock system is as follows.

Item	Personalization Operation
Initial value	Guest
Profile linked smart phone key	Linked profile
Profile unlinked smart phone key	Recently activated profile
NFC card key	
Smart key	

- The personalization function using the digital key can be operated after linking the digital key on the infotainment system profile menu.
- Personalization function can be used while vehicle is stopped for you and your vehicle’s safety.

### Vehicle personalization with digital key

The available personalization function in the vehicle is as follows.

System	Personalization Item	
User's Setting Mode	Lamp	Blink number of one-touch signal lamps
	Cluster	Information display on the cluster, Voice volume, Welcome sound
	Door	Automatic door lock/unlock, Two Press Unlock
Infotainment system	Navigation	Preferred volume of the navigation system, Recent destination
	User preset	My menu list settings, Radio preset
	Phone connectivity	Bluetooth preferential connect CarPlay/Android Auto On/Off
Air conditioning	Operating condition	Latest operation setup of the following functions: Temperature, AUTO, air flow direction, air volume, air conditioner, air intake control, SYNC, Front windshield defroster, OFF

For more information of personalization, refer to the infotainment system manual.



### CAUTION

If you leave the digital key after locking or unlocking the doors or starting up the vehicle with the smart key, the doors can be locked by the central door lock. Please carry around the digital key all the time.

## DOOR LOCKS

### Operating Door Locks From Outside the Vehicle

#### **Mechanical key**

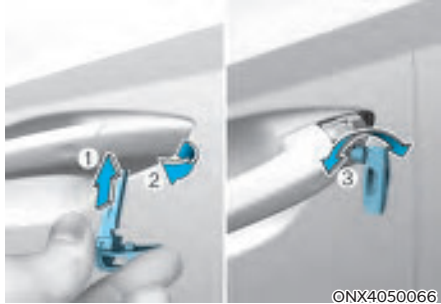

1. Pull out the door handle.
2. Press the release button (1) located inside the bottom part of the cover with a mechanical key or flat-head screwdriver.
3. Carefully pull outward on the cover while continuing to press the release button to remove the cover and expose the key cylinder.
4. Insert the mechanical key into the key cylinder and rotate clockwise to unlock the vehicle and counterclockwise to lock the vehicle.

Once the doors are unlocked, they may be opened by pulling the door handle.

When closing the door, push the door by hand. Make sure that doors are closed securely.

#### **i Information**

Be careful when locking the door by mechanical key operation, only the driver's door can be locked/unlocked.

#### **i Information**

- Avoid scratching or breaking the plastic material. Do not lose the key cylinder cover.
- In the case of trying to remove the key cylinder cover in cold climate or freezing temperatures, use extra caution. If the key cylinder cover freezes and cannot be removed easily, lightly tap on the cover or try to warm the cover by placing your hands around it and blowing warm air, etc.
- Do not apply excessive force to the door and door handle. It may be damaged.

### Remote key



To lock the doors, press the Door Lock button (1) on the remote key.

To unlock the doors, press the Door Unlock button (2) on the remote key.

Once the doors are unlocked, they may be opened by pulling the door handle.

When closing the door, push the door by hand. Make sure that doors are closed securely.

### Smart key



Press the button on the driver's outside door handle or touch the touch sensor on the door handle (the engraved part) while carrying the smart key with you or press the Door Unlock button on the Smart Key, the driver's door will unlock. If you press the button on the front passenger's outside door, all doors will unlock.

Once the doors are unlocked, they may be opened by pulling the door handle. When closing the door, push the door by hand. Make sure that doors are closed securely.

### **i** Information

- **In cold and wet climates, door lock and door mechanisms may not work properly due to freezing conditions.**
- **If the door is locked/unlocked multiple times in rapid succession with either the vehicle key or door lock switch, the system may stop operating temporarily in order to protect the circuit and prevent damage to system components.**

### ***In case of an emergency***



If the electrical power door lock switch is not operating (ex. dead car battery) the only way to lock the door(s) is with the mechanical key from the outside key hole.

Doors without an outside key hole can be locked as follows:

1. Open the door.
2. Insert the key into the emergency door lock hole and turn the key horizontally to lock.
3. Close the door securely.

### ***i* Information**

If the electrical power to door lock switch is not operating (ex. dead car battery) and the trunk is closed, you will not be able to open the trunk until power is restored.

### **Operating Door Unlocks from Inside the Vehicle**

#### ***With the door inside handle***



#### **Driver door & Passenger door**

If the inner door handle is pulled when the door is locked, the door will unlock and open.

#### **Rear Door - Two Pull Operation**

If the inner door handle is pulled once when the door is locked, the door will unlock. If the inner door handle is pulled once more, the door will open.

### ***i* Information**

If a power door lock ever fails to function while you are in the vehicle try one or more of the following techniques to exit:

- Operate the door unlock feature repeatedly (both electronic and manual) while simultaneously pulling on the door handle.
- Operate the other door locks and handles.
- Lower a front window and use the mechanical key to unlock the door from outside.

### With the driver door lock/unlock switch

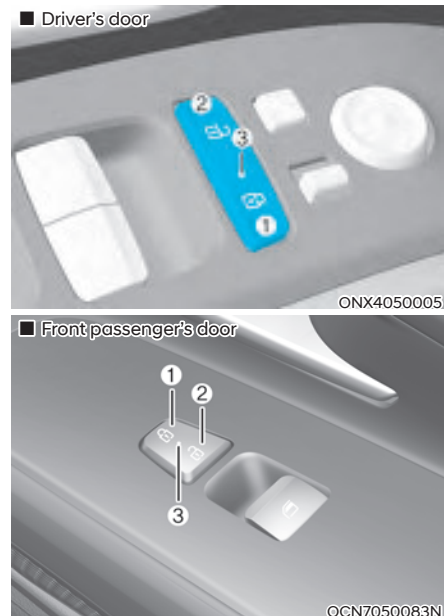

When pressing the (🔒) portion (1) on the switch, all vehicle doors will lock.

- If any door is opened, the doors will not lock even though the lock button (1) of the driver door lock switch is pressed.
- If the smart key is in the vehicle and any door is opened, the doors will not lock even though the lock button (1) of the driver door lock switch is pressed.

When pressing the (🔓) portion (2) on the switch, all vehicle doors will unlock.

When all vehicle doors are locked, the indicating lights (3) on the driver's door and passenger's door will turn on. If any door is unlocked, the indicator will turn off.

### WARNING

- The doors should always be fully closed and locked while the vehicle is in motion. If the doors are unlocked, the risk of being thrown from the vehicle in a crash is increased.
- Do not pull the inner door handle of the driver's or passenger's door while the vehicle is moving.

### WARNING

Do not leave children or animals unattended in your vehicle. An enclosed vehicle can become extremely hot, causing death or serious injury to unattended children or animals who cannot escape the vehicle. Children might operate features of the vehicle that could injure them, or they could encounter other harm, possibly from someone gaining entry to the vehicle.

### WARNING

Always secure your vehicle.

Leaving your vehicle unlocked increases the potential risk to you or others from someone hiding in your vehicle.

To secure your vehicle, while depressing the brake, shift the gear to the P (Park) position, engage the parking brake, and place the ignition switch to the LOCK/OFF position, close all windows, lock all doors, and always take the key with you.



### CAUTION

Opening a door when something is approaching may cause damage or injury. Be careful when opening doors and watch for vehicles, motorcycles, bicycles or pedestrians approaching the vehicle in the path of the door.



### WARNING

If you stay in the vehicle for a long time while the weather is very hot or cold, there are risks of injuries or danger to life. Do not lock the vehicle from the outside when someone is in the vehicle.

### Auto Door Lock/Unlock Features *Impact sensing door unlock system*

All doors will be automatically unlocked when an impact causes the air bags to deploy.

### Child-protector Rear Door Locks



The child safety lock is provided to help prevent children seated in the rear from accidentally opening the rear doors. The rear door safety locks should be used whenever children are in the vehicle.

The child safety lock is located on the edge of each rear door. When the child safety lock is in the lock position, the rear door will not open if the inner door handle is pulled.

To lock the child safety lock, insert a small flat blade tool (like a screwdriver or similar) (1) into the slot and turn it to the lock position as shown.

To allow a rear door to be opened from inside the vehicle, unlock the child safety lock.



### WARNING

If children accidentally open the rear doors while the vehicle is in motion, they could fall out of the vehicle. The rear door safety locks should always be used whenever children are in the vehicle.



## THEFT-ALARM SYSTEM

This system helps to protect your vehicle and valuables. The horn will sound and the hazard warning lights will blink continuously if any of the following occur:

- A door is opened without using the remote key or smart key.
- The tailgate is opened without using the remote key or smart key.
- The engine hood is opened.

The alarm continues for 30 seconds, then the system resets. To turn off the alarm, unlock the doors with the remote key or smart key.

The Theft Alarm System automatically sets 30 seconds after you lock the doors and the tailgate. For the system to activate, you must lock the doors and tailgate from outside the vehicle by doing one of the following:

- Using the remote key or smart key
- Pressing the button on the outside of the door handle with the smart key in your possession (available with button type)
- Touching the touch sensor on the outside of the door handle with the smart key in your possession (available with touch sensor type)

The hazard warning lights will blink and the chime will sound once to indicate the system is armed.

Once the security system is set, opening any door, the tailgate, or the hood without using the remote key or smart key will cause the alarm to activate.

The Theft Alarm System will not set if the hood, the tailgate, or any door is not fully closed. If the system will not set, check the hood, the tailgate, or the doors are fully closed.

Do not attempt to alter this system or add other devices to it.

### **i** Information

- **Do not lock the doors until all passengers have left the vehicle. If the remaining passenger leaves the vehicle when the system is armed, the alarm will be activated.**
- **If the vehicle is not disarmed with the remote key or smart key, open the doors by using the mechanical key and place the ignition switch in the ON position (for remote key) or start the engine (for smart key) by directly pressing the Engine Start/Stop button with the smart key.**
- **If the system is disarmed by unlocking the vehicle, but neither a door or the tailgate is opened within 30 seconds, the doors will relock and the system will rearm automatically.**

### **i** Information



Vehicles equipped with a theft alarm system will have a label attached to the vehicle with the following words:

1. **WARNING**
2. **SECURITY SYSTEM**

## REAR OCCUPANT ALERT (ROA) (IF EQUIPPED)

Rear Occupant Alert is provided to prevent a driver from leaving a vehicle with a rear passenger left in the vehicle.

### Rear Occupant Alert Operation

When you turn off the engine and open the driver's door after opening and closing the rear door or tailgate, the 'Check rear seats' warning message appears on the cluster.



### WARNING

Rear Occupant Alert provides information to the driver to check the rear seats but it does not detect whether there is an object or passenger. Always check the rear seats when leaving the vehicle.



### Information

The open and close history of the rear doors are initialized if the driver turns off the engine and lock vehicle doors.

However, the alarm may sound again whenever the driver's door is opened if the previous history of the rear doors are not initialized.



### WARNING

Even if your vehicle is equipped with Rear Occupant Alert (ROA), always make sure to check the rear seat before you leave the vehicle. Rear Occupant Alert (ROA) may not operate when:

- Movement does not continue for a certain period of time or the movement is small.
- A child is not seated in a child restraint system.
- Movement is detected in areas other than the rear seats.
- The rear passenger is covered with a fabric containing metallic substance such as a blanket.
- An object in the vehicle blocks the sensor.
- The sensor is contaminated by foreign material.
- An animal at the rear seat or luggage compartment is not large enough to be detected by the sensor or there is hardly any movement.
- Attaching objects or modifying the interior ceiling, or the interior ceiling is deformed or damaged.
- There are electronic interference around the vehicle.
- Other environmental reasons that may affect the system.

## STEERING WHEEL

### Electric Power Steering (EPS)

The electric power steering system assists you with steering the vehicle. If the vehicle is turned off or if the power steering system becomes inoperative, you may still steer the vehicle, but it will require increased steering effort.

Should you notice any change in the effort required to steer during normal vehicle operation, have the system checked by an authorized HYUNDAI dealer.



#### CAUTION

If Electric Power Steering does not operate normally, the  warning light and the message 'Check motor driven power steering' will illuminate on the instrument cluster. You may steer the vehicle, but it will require increased steering efforts. Take your vehicle to an authorized HYUNDAI dealer or to a service station and have the system checked as soon as possible.

### Information

The following symptoms may occur during normal vehicle operation:

- The steering effort may be high immediately after placing the ignition switch in the ON position.  
This happens as the system performs the EPS system diagnostics. When the diagnostics are completed, the steering wheel effort will return to its normal condition.
- When the battery voltage is low, you might have to put more steering effort. However, it is a temporary condition so that it will return to normal condition after charging the battery.
- A click noise may be heard from the EPS relay after the ignition switch is in the ON or LOCK/OFF position.
- Motor noise may be heard when the vehicle is at a stop or at a low driving speed.
- When you operate the steering wheel in low temperatures, abnormal noise may occur. If the temperature rises, the noise will disappear. This is a normal condition.
- When an error is detected from EPS, the steering effort assist function will not be activated in order to prevent fatal accidents. Instrument cluster warning lights may be on or the steering effort may be high. If these symptoms occur, drive the vehicle to a safe area as soon as it is safe to do so. Have the system checked by an authorized HYUNDAI dealer as soon as possible.

### Tilt / Telescopic Steering

When adjusting the steering wheel to a comfortable position, adjust the steering wheel so that it points toward your chest, not toward your face. Make sure you can see the instrument cluster warning lights and gauges. After adjusting, push the steering wheel both up and down to be certain it is locked in position.

Always adjust the position of the steering wheel before driving.



#### WARNING

**NEVER** adjust the steering wheel while driving. This may cause loss of vehicle control resulting in an accident.



To adjust the steering wheel angle and height:

1. Pull down the lock-release lever (1).
2. Adjust the steering wheel to the desired angle (2) and distance forward/back (3).
3. Pull up the lock-release lever to lock the steering wheel in place.



#### CAUTION

**While adjusting the steering wheel angle and height, please do not push or pull it hard since the fixture can be damaged.**



#### Information

Sometimes the lock release lever may not engage completely. This may occur when the gears of the locking mechanism do not completely mesh. If this occurs, pull down on the lock-release lever, readjust the steering wheel again, and then pull back up on the release lever to lock the steering wheel in place.

### Heated Steering Wheel (if equipped)



When the ignition switch is in the ON position or when the engine is running, press the heated steering wheel button to warm the steering wheel.

The indicator on the button will illuminate.

To turn the heated steering wheel off, press the button again. The indicator on the button will turn off.

- Automatic Controls for the Driver Based on Climate Control System Settings (if equipped)
  - The Automatic Comfort Control feature can control the steering wheel heater operation according to the ambient temperature and the set climate control temperature while the engine is running. If the heated steering wheel switch is pressed while the Automatic Comfort Control feature is operating, then the heated steering wheel operation will be controlled manually. The Auto Comfort Control feature is enabled from the Vehicle Settings menu on the navigation infotainment screen.
  - The heated steering wheel defaults to the OFF position whenever the ignition switch is ON. However, if the Auto Comfort Control function is ON, the heated steering wheel will turn on and off depending on the ambient temperature and the set climate control temperature.

**For more details, contact an authorized HYUNDAI dealer.**

### **i** Information

**The heated steering wheel will turn off automatically approximately 30 minutes after the heated steering wheel is turned on.**

### **NOTICE**

**Do not install any cover or accessory on the steering wheel. This cover or accessory could cause damage to the heated steering wheel system.**

### Horn



To sound the horn, press the area indicated by the horn symbol on your steering wheel (see illustration). The horn will operate only when this area is pressed.

### **NOTICE**

**Do not strike the horn severely to operate it, or hit it with your fist. Do not press on the horn with a sharp-pointed object.**

## MIRRORS

### Inside Rearview Mirror

Before driving your vehicle, check to see that your inside rearview mirror is properly positioned. Adjust the rearview mirror so that the view through the rear window is properly centered.

#### **WARNING**

**Make sure your line of sight is not obstructed. Do not place objects in the rear seat, cargo area, or behind the rear headrests which could interfere with your vision through the rear window.**

#### **WARNING**

**To prevent serious injury during an accident or deployment of the air bag, do not modify the rearview mirror and do not install a wide mirror.**

#### **WARNING**

**NEVER adjust the mirror while driving. This may cause loss of vehicle control resulting in an accident.**

#### **NOTICE**

**When cleaning the mirror, use a paper towel or similar material dampened with glass cleaner. Do not spray glass cleaner directly on the mirror as this may cause the liquid cleaner to enter the mirror housing.**

### *Day/night rearview mirror (if equipped)*

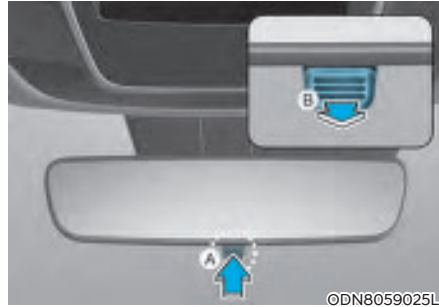

[A]: Day, [B]: Night

Make this adjustment before you start driving and while the day/night lever is in the day position.

Pull the day/night lever towards you to reduce glare from the headlamps of the vehicles behind you during night driving.

Remember that you lose some rearview clarity in the night position.

### **Electrochromic Mirror with Homelink System (if equipped)**

Your vehicle may be equipped with a Gentex Automatic-Dimming Mirror with an Integrated HomeLink® Wireless Control System.

During nighttime driving, this feature will automatically detect and reduce rearview mirror glare. The HomeLink® Universal Transceiver allows you to activate your garage door(s), electric gate, home lighting, etc.

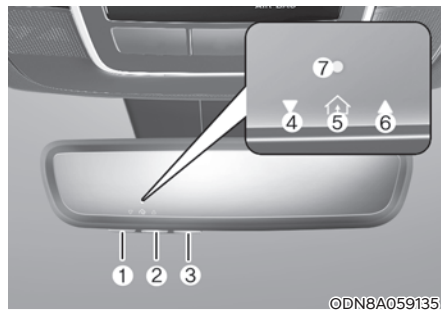

- (1) HomeLink Channel 1
- (2) HomeLink Channel 2
- (3) HomeLink Channel 3
- (4) Garage Door Opener Status Indicator: Closing or Closed
- (5) HomeLink Operation Indicator
- (6) Garage Door Opener Status Indicator: Opening or Opened
- (7) HomeLink User Interface Indicator

### **Integrated HomeLink® Wireless Control System**

The HomeLink® Wireless Control System provides a convenient way to replace up to three hand held radio-frequency transmitters used to activate compatible devices such as gate operators, garage door openers, entry door locks, security systems, and home lighting.

#### **NOTICE**

HomeLink® operates while the ignition switch is in the ACC or ON position for safety reasons. It is to prevent unintentional security problems from happening when the vehicle is parked outside the garage.



#### **WARNING**

Before programming HomeLink® to a garage door opener or gate operator, make sure people and objects are out of the way of the device to prevent potential harm or damage. Do not use the HomeLink® with any garage door opener that lacks the safety stop and reverse features required by U.S. federal safety standards (this includes any garage door opener model manufactured before April 1, 1982). A garage door that cannot detect an object - signaling the door to stop and reverse - does not meet current U.S. federal safety standards. Using a garage door opener without these features increases the risk of serious injury or death.

For more information, contact HomeLink® at [www.homelink.com](http://www.homelink.com), or call Home-Link customer support at 1-800-355-3515.

It is also recommended that a new battery be replaced in the handheld transmitter of the device being trained to HomeLink® for quicker training and accurate transmission of the radio frequency.

### 1. Programming HomeLink®

The following steps show how to program HomeLink. If you have any questions or are having difficulty programming your HomeLink buttons, refer to the HomeLink website or call the HomeLink customer support toll-free number. Do this before going back to the dealer who sold you the car.

- Visit the HomeLink website at: [www.homelink.com](http://www.homelink.com). Then at the top of the page, choose your vehicle make. Then watch the YouTube video, and/or access additional website information.
- If you choose to access the website via your cell phone, scan the QR code.



- Or call HomeLink customer support at 1-800-355-3515 (Please have the vehicle make/model and the opener device make/model readily available.)

### 1) Programming Preparation

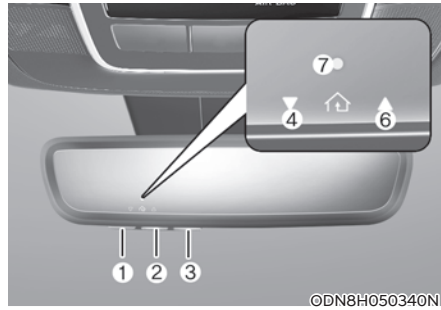

1. When programming a garage door opener, it is advised to park the vehicle outside of the garage.
2. It is recommended that a new battery be placed in the handheld transmitter of the device being programmed to HomeLink for quicker training and accurate transmission of the radio-frequency signal.
3. Place the ignition switch to the ACC (Accessory) position for programming of HomeLink.



## 2) Programming a New HomeLink®



1. Press and release the HomeLink button (1), (2) or (3), you would like to program. The HomeLink indicator light (7) will flash orange slowly (if not, perform the steps of “Erasing HomeLink Buttons” section, and start over).



2. Position the garage door opener remote 1 – 3 inches (2 – 8cm) away from the HomeLink buttons.
3. While the HomeLink indicator light (7) is flashing orange, press and hold the hand-held remote button. Continue pressing the handheld remote button until the HomeLink indicator light (7) changes from orange to green. You may now release the handheld remote button.

4. Wait until your garage door comes to a complete stop, regardless of position, before proceeding to the next steps.
5. Press and release the HomeLink button you are programming and observe the indicator light.
  - If the indicator light remains solid green, your device should operate when the HomeLink button is pressed. At this point, if your device operates, programming is complete.
  - If the indicator light rapidly flashes green, firmly press, hold for two seconds and release the HomeLink button up to three times in a row slowly to complete the programming process. Do not press the HomeLink button rapidly. At this point if your device operates, programming is complete. If the device does not operate, continue with step 6.
6. At the garage door opener motor, (security gate motor, etc.) locate the “Learn”, “Smart”, “Set” or “Program” button. This can usually be found where the hanging antenna wire is attached to the motor-head unit (see the device’s manual to identify this button). The name and color of the button may vary by manufacturer.

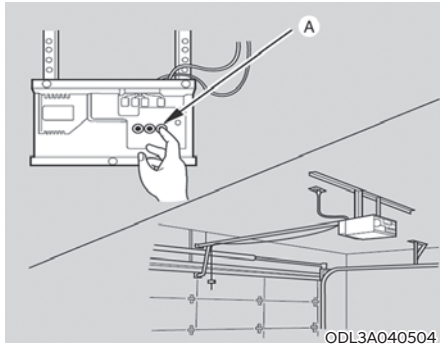

- \* A ladder and/or second person may simplify the following steps.
- 7. Firmly press and release the “Learn”, “Smart”, “Set” or “Program” button. You now have up to 30 seconds in which to complete the next step.
- 8. Return to the vehicle and firmly press, hold for two seconds and release, the HomeLink button up to three times in a row slowly. Do not press the HomeLink button rapidly. As soon as you see the garage door start to move, stop pressing any buttons until a few seconds after the garage door has come to a complete stop, regardless of position. At this point, programming is complete and your device should operate when the HomeLink button is pressed and released.

### 3) Two-Way Communication Programming (For select garage door openers)

If your garage door opener has the ‘myQ’ logo on its side, your opener likely has Two-Way Communication capability. HomeLink has the capability to establish Two-Way Communication with your garage door opener. HomeLink can receive and display “closing” or “opening” status messages from compatible garage door openers. At any time, Home-Link can also recall and display the last recorded status communicated by the garage door opener to indicate your garage door being “closed” or “opened”.

To check if your garage door opener is compatible with this feature, refer to [www.homelink.com/compatible/Two-way-Communication](http://www.homelink.com/compatible/Two-way-Communication). If your garage door opener has this functionality, AND the Two-Way Communication indicators (4), (6) in the mirror appear while the garage door is opening/closing, then no further steps are needed. Two-Way Communication Programming is already complete. However, if your garage door opener has this functionality, AND the Two-Way Communication indicators (4), (6) in the mirror DO NOT appear while the garage door is opening/closing, use the following instructions to enable this functionality.

1. In your vehicle, press and hold the programmed HomeLink button for 2 seconds, then release. Confirm that the garage door is moving. AFTER it stops, you will have one minute to complete the following steps:

- \* A ladder and/or second person may simplify the following steps.

2. On your garage door opener in your garage, locate the “Learn” button (usually near where the hanging antenna wire is attached to the garage door opener). If there is difficulty locating this button, reference the device’s owner’s manual.
3. Press and release the “Learn” button.
4. A light on your garage door opener may flash, and your Two-Way Communication indicators (4), (6) in your vehicle may flash, confirming completion of the process.
5. Return to the vehicle and firmly press and release the programmed HomeLink button to activate your garage door. The Two-Way Communication indicators (4), (6) flash in orange when the door is moving. Do not make any additional button presses until AFTER the garage door has come to a complete stop.
6. Your Two-Way Communication programming is now complete.

#### Information

**If your garage door opener has Two-Way Communication functionality, it is possible for HomeLink to stop functioning the garage door shortly after initial programming, IF the Two-Way Communication Programming wasn’t properly completed. This usually happens after the first 10 times a programmed HomeLink button is pressed. If you experience this, completing the “Programming a New HomeLink Button” and “Two-Way Communication Programming” will restore door operation.**

#### 4) Canadian Programming

Canadian radio-frequency laws require transmitter remote signals to “time-out” (or quit) after a couple seconds of transmission, which may not be long enough for HomeLink to pick up the signal during programming.

If you live in Canada or you are having difficulties programming a gate operator or garage door opener by using the programming procedures, replace “Programming a New HomeLink Button” step 3 with the following:

While the HomeLink indicator light (7) is flashing orange, press and release (“cycle”) your device’s handheld remote every two seconds until the HomeLink indicator light (7) changes from orange to green. You may now release the hand-held remote button. Then proceed with “Programming a New HomeLink Button” step 4.

## 2. Operating HomeLink®

### 1) Operating HomeLink®



1. Press and release the desired programmed HomeLink button (1, 2 or 3).

### **i** Information

The HomeLink indicator (7) should light green, solid or flashing, and your programmed device should operate. If your device does not operate, the HomeLink programming was not successful, and you'll need to reprogram the button.

### 2) Two-Way Communication Display Behavior



1. Press and release one of the programmed HomeLink buttons (1, 2 or 3).



2. The indicator (4) and (6) operates as below, if your garage door opener has Two-Way Communication functionality.
  - If the indicator (4) flashes in Orange, it indicates that the garage door is "Closing".
  - The indicator (4) turns solid green once the garage door has closed.
  - If the indicator (6) flashes in Orange, it indicates that the garage door is "Opening".
  - The indicator (6) turns solid green once the garage door has fully opened.
  - If the indicator (4) or (6) does not turn to green, it indicates that the last status of garage door was not received properly. The HomeLink mirror tries to receive the last known status of the garage door for a few seconds.

### 3) Recalling Garage Door Status

HomeLink mirror with Two-Way Communication provides a way to view the last stored message from the garage door opener. In order to recall the last known status of the last activated device, press the buttons “1 and 2” OR “2 and 3” simultaneously.

- If the indicator (4) appears solid Green, it indicates that the last activated device was “closed” properly.
- If the indicator (6) appears solid Green, it indicates that the last activated device was “open” properly.

### 3. Erasing HomeLink® Buttons

#### 1) Erasing and Reprogramming a Single HomeLink® Button:

1. Press and hold the desired HomeLink button you want to re-program. DO NOT release the button.
2. The HomeLink indicator light (7) will illuminate solid green. Release the button as soon as the HomeLink indicator light (7) begins to flash orange, usually about 20 seconds.
3. Proceed with the steps in the “Programming a New HomeLink Button” section.

#### **i** Information

**If you do not complete the re-programming of a new device to the button, it will revert to the previously stored programming.**

#### 2) The following instructions will erase ALL HomeLink® programming from ALL buttons:



1. Press and hold the buttons (1) and (3) simultaneously.
2. The HomeLink indicator light (7) will illuminate solid Orange for about 10 seconds.
3. Release the buttons once the HomeLink indicator light (7) changes to Green and flashes rapidly.
4. Now all three HomeLink buttons (1), (2) and (3) are cleared of any programming.

#### **i** Information

**HomeLink® and the HomeLink® House logo are registered trademarks of Gentex Corporation.**

**The myQ logo is a registered trademark of The Chamberlain Group, Inc.**

### **FCC (USA) and ISED (Canada)**

This device complies with FCC rules part 15 and Innovation, Science, and Economic Development Canada RSS-210. Operation is subject to the following two conditions: (1) This device may not cause harmful interference, and (2) This device must accept any interference that may be received including interference that may cause undesired operation. **WARNING:** The transmitter has been tested and complies with FCC and ISED rules. Changes or modifications not expressly approved by the party responsible for compliance could void the user's authority to operate the device.

This equipment complies with FCC and ISED radiation exposure limits set forth for an uncontrolled environment. End Users must follow the specific operating instructions for satisfying RF exposure compliance. This transmitter must be at least 20cm from the user and must not be co-located or operating in conjunction with any other antenna or transmitter.

### **FCC (Etats-Unis) et ISED (Canada)**

Cet appareil est conforme aux règlements de la FCC, section 15, et au CNR-210 d'Innovation, Sciences et Développement économique Canada. Le fonctionnement est assujéti aux deux conditions suivantes : (1) cet appareil ne doit pas causer d'interférences nuisibles et (2) cet appareil doit accepter toute interférence reçue, y compris celle qui pourrait entraîner un dysfonctionnement. **MISE EN GARDE :** L'émetteur a subi des tests et est conforme aux règlements de la FCC et d'ISDE. Les changements ou modifications non approuvés explicitement par la partie responsable de la conformité pourraient rendre caduque l'autorisation de l'utilisateur de se servir du dispositif.

Cet appareil est conforme aux limites d'exposition aux radiations de la FCC et d'ISDE établies pour un environnement non contrôlé. Les utilisateurs finaux doivent respecter les instructions d'utilisation spécifiques pour satisfaire aux exigences de conformité aux expositions de RF. L'émetteur doit se trouver à 20 cm au minimum de l'utilisateur et ne doit pas être situé au même endroit que tout autre émetteur ou antenne ni fonctionner avec un autre émetteur ou antenne.

### **Méjico**

La operación de este equipo está sujeta a las siguientes dos condiciones: (1) es posible que este equipo o dispositivo pueda no causar interferencia dañina, y (2) este dispositivo o dispositivos deben aceptar cualquier interferencia, que incluye la interferencia que puede causar su operación no deseada.

HomeLink 5 Programing Flow Chart

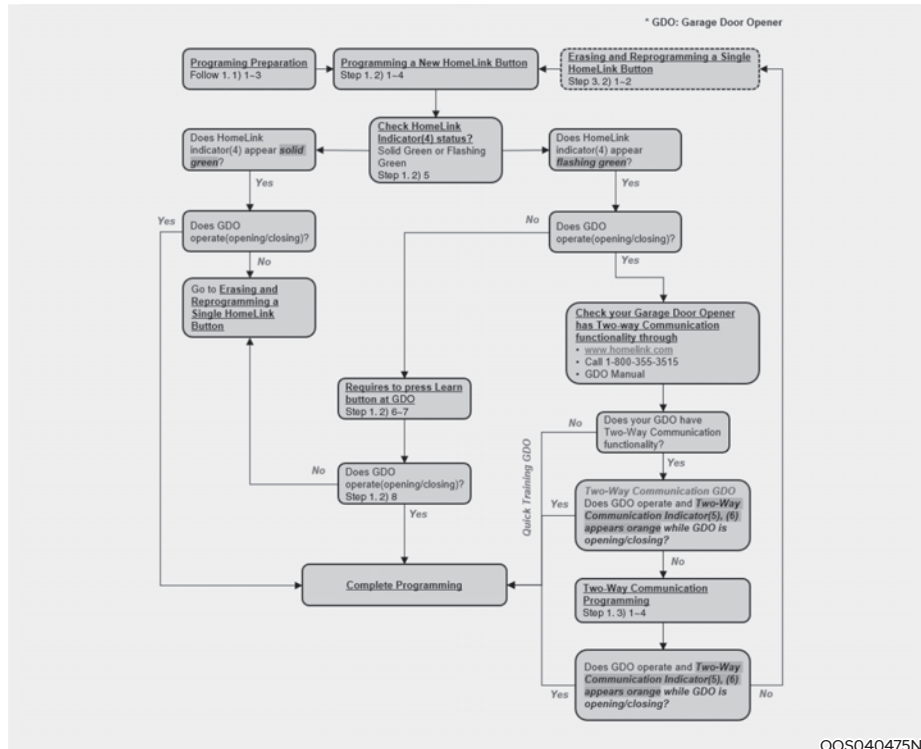

## Side View Mirrors



Your vehicle is equipped with both left-hand and right-hand side view mirrors. The mirrors can be adjusted remotely with the mirror adjustment control switch. The side view mirrors can be folded manually to help prevent damage when going through an automatic car wash or when passing through a narrow street.

The right side view mirror is convex. Objects seen in the mirror are closer than they appear.

Use the inside rear view mirror or look back directly to determine the actual distance of other vehicles prior to changing lanes.

Make sure to adjust the side view mirrors to your desired position before you begin driving.

### **WARNING**

Do not adjust or fold the side view mirrors while driving. This may cause loss of vehicle control resulting in an accident.

### **NOTICE**

- Do not scrape ice off the mirror face; this may damage the surface of the glass.
- If the mirror is jammed with ice, do not adjust the mirror by force. Use an approved spray de-icer (not radiator antifreeze) spray, or a sponge or soft cloth with very warm water, or move the vehicle to a warm place and allow the ice to melt.
- Do not clean the mirror with harsh abrasives, fuel or other petroleum based cleaning products.



### ***Adjusting the side view mirrors***



1. Move the lever (1) either to the L (left side) or R (right side) to select the side view mirror you would like to adjust.
2. Use the mirror adjustment control (2) to position the selected mirror up, down, left or right.
3. After adjustment, move the lever (1) to the middle to prevent inadvertent adjustment.

### ***Folding the side view mirror***



To fold the side view mirror, grasp the housing of the mirror and then fold it toward the rear of the vehicle.

## WINDOWS

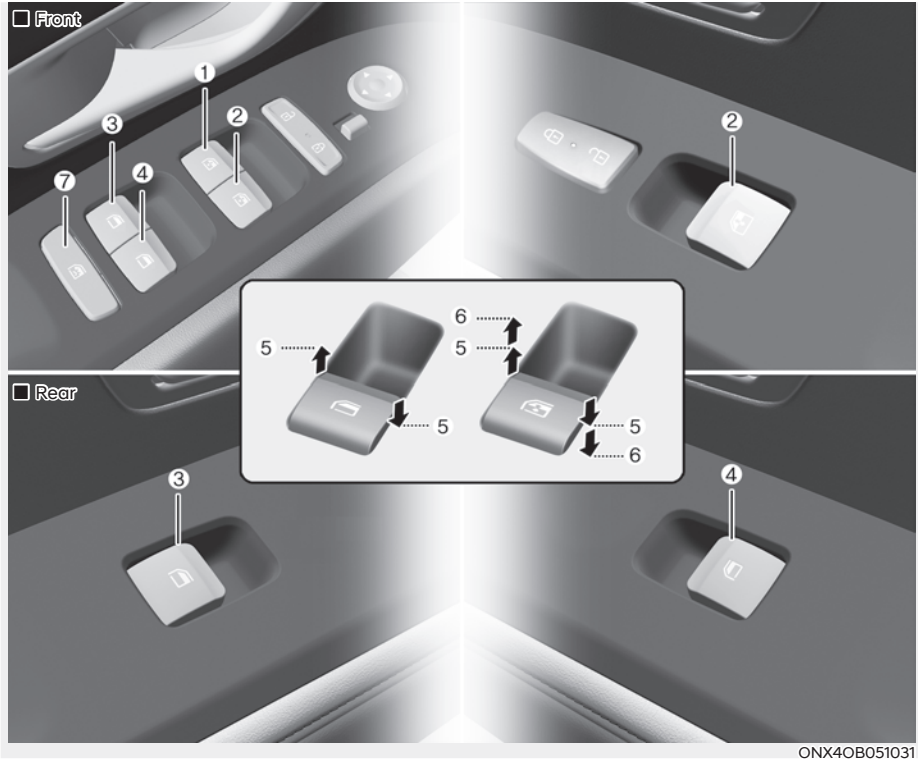

- (1) Driver's door power window switch
  - (2) Front passenger's door power window switch
  - (3) Rear door (left) power window switch
  - (4) Rear door (right) power window switch
  - (5) Window opening and closing
  - (6) Automatic power window\*
  - (7) Power window lock switch
- \* : if equipped

## Power Windows

The ignition switch must be in the ON position to be able to raise or lower the windows. Each door has a Power Window switch to control that door's window. The driver has a Power Window Lock switch which can block the operation of passenger windows. The power windows will operate for about 3 minutes after the ignition is turned OFF or if the ignition is placed in the ACC position, as long as the front doors remain closed.

If the front doors are opened, battery power is turned OFF and the Power Windows will not operate.

### Window opening and closing



To open:

Press the window switch down to the first detent position (5). Release the switch when you want the window to stop.

To close:

Pull the window switch up to the first detent position (5). Release the window switch when you want the window to stop.

### Auto down window (if equipped)

Pressing the power window switch momentarily to the second detent position (6) completely lowers the window even when the switch is released.

To stop the window at the desired position while the window is in operation, pull up or press down and release the switch.

### Auto up/down window (if equipped)

Pressing or pulling up the power window switch momentarily to the second detent position (6) completely lowers or lifts the window even when the switch is released. To stop the window at the desired position while the window is in operation, pull up or press down and release the switch.

### Resetting the power windows

If the power windows do not operate normally, the automatic power window system must be reset as follows:

1. Press the ignition switch to the ON position.
2. Close the window and continue pulling up on the power window switch for at least one second.

If the power windows do not operate properly after resetting, have the system checked by an authorized HYUNDAI dealer.

**Automatic reverse (if equipped)**



If a window senses any obstacle while it is closing automatically, it will stop and lower approximately 12 in. (30 cm) to allow the object to be cleared.

If the window detects the resistance while the power window switch is pulled up continuously, the window will stop upward movement then lower approximately 1 in. (2.5 cm).

If the power window switch is pulled up continuously again within 5 seconds after the window is lowered by the automatic window reverse feature, the automatic window reverse will not operate.

***i* Information**

The automatic reverse feature is only active when the “Auto Up” feature is used by fully pulling up the switch to the second detent.

**NOTICE**

Do not install any accessories on the windows. The automatic reverse feature may not operate.

** WARNING**

**Make sure body parts or other objects are safely out of the way before closing the windows to avoid injuries or vehicle damage.**

**Objects less than 0.16 in (4 mm) in diameter caught between the window glass and the upper window channel may not be detected by the automatic reverse window and the window will not stop and reverse direction.**

### Power window lock button



The driver can disable the power window switches on the rear passenger doors by pressing the power window lock button.

When the power window lock button is pressed:

- The driver's master control can operate all the power windows.
- The front passenger's control can operate the front passenger's power window.
- The rear passenger's control cannot operate the rear passengers' power window.

### **WARNING**

Do not allow children to play with the power windows. Keep the driver's door power window lock button in the **LOCK** position. Serious injury or death can result from unintentional window operation by a child.

### **NOTICE**

- To prevent possible damage to the power window system, do not open or close two windows or more at the same time. This will also ensure the longevity of the fuse.
- Never try to operate the main switch on the driver's door and the individual door window switch in opposite directions at the same time. If this is done, the window will stop and cannot be opened or closed.

### Rear Sliding Window (if equipped)

Your vehicle is equipped with a rear sliding window behind the rear seats.

#### ***Opening the rear sliding window***

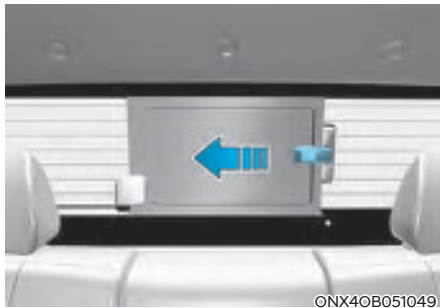

Push the lock release lever and slide the rear sliding window to the left.

#### ***Closing the rear sliding window***

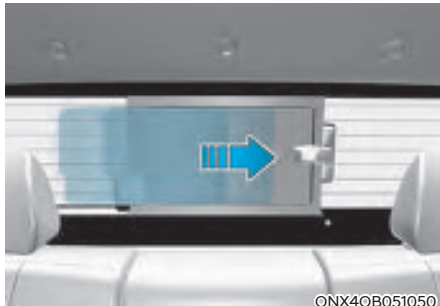

Slide the rear sliding window to the right until it is securely locked.

### **WARNING**

- Make sure heads, hands, arms or any other body parts or objects are out of the way before closing the rear sliding window.
- Close the rear sliding window to prevent theft when leaving the vehicle.
- Keep the rear sliding window closed while driving. If the rear sliding window is opened, luggage may be unexpectedly thrown out and cause an accident. Also, exhaust gases may enter the vehicle. This could result in serious injury or death.

## SUNROOF (IF EQUIPPED)

If your vehicle is equipped with a sunroof, you can slide or tilt your sunroof with the sunroof switch located on the overhead console.



The sunroof can only be operated when the ignition switch or Engine Start/Stop button is in the ON or START position.

The sunroof can be operated for approximately 3 minutes after the ignition switch or Engine Start/Stop button is in the ACC or LOCK/OFF position. However, if the front door is open, the sunroof cannot be operated even within the 3 minute period.

### WARNING

- Never adjust the sunroof or sunshade while driving. This could result in loss of control and an accident that may cause injury, or property damage.
- Do not leave the engine running and the key in your vehicle with unsupervised children. Unattended children could operate the sunroof, which could result in serious injury.
- Do not sit on the top of the vehicle. It may cause injury or vehicle damage.

### NOTICE

Do not operate the sunroof when roof bars are installed on the vehicle or when there is luggage on the roof.

## Sunshade



Use the sunshade to block direct sunlight coming through the sunroof glass.

Open or close the sunshade by hand.

### Information

The sunshade opens automatically when the sunroof glass is opened, but the sunshade does not close automatically when the sunroof glass is closed. Also, only the sunshade cannot be closed when the sunroof glass is opened.

### NOTICE

Do not pull the sunshade up or down, or apply excessive force as such action may damage the sunshade or cause it to malfunction.

### Tilt Open/Close

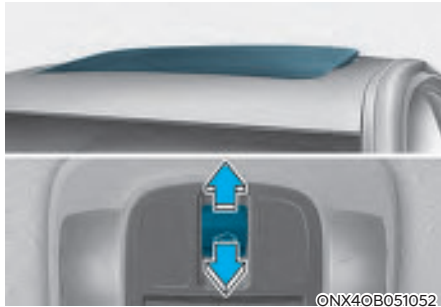

- Push the sunroof switch upward, the sunroof glass tilts open.
- Push the sunroof switch forward when the sunroof glass is tilt opened, the sunroof glass closes.

To stop the sunroof movement at any point, push the sunroof switch in any direction.

#### **i** Information

**The sunroof glass cannot slide open and tilt open at the same time. You cannot tilt the sunroof glass open while the sunroof glass is slide open. Also, you cannot slide the sunroof glass open while the sunroof is tilt open. Slide open or tilt open with the sunroof glass when the sunroof glass is completely closed.**

### Slide open/close

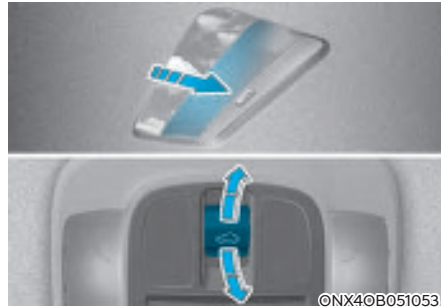

- Push the sunroof switch rearward, the sunshade and sunroof glass slide open.
- Push the sunroof switch forward, only the sunroof glass closes.
- Push the sunroof switch forward or rearward to the first detent position, the sunroof glass moves until the switch is released.
- Push the sunroof switch forward or rearward to the second detent position, the sunroof glass operates automatically (auto slide feature).
- To stop the sunroof movement at any point, push the sunroof switch in any direction.

#### **i** Information

**To reduce wind noise while driving, we recommend that you drive at the recommended position before the maximum slide open position.**



### Automatic Reversal

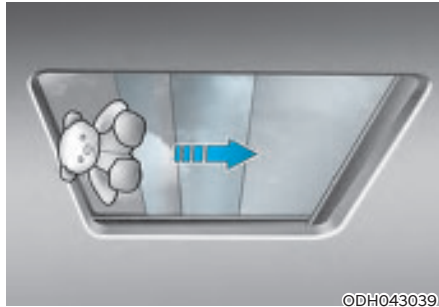

If the sunroof glass senses any obstacle while it is closing automatically, it will reverse direction then stop at a certain position.

The auto reverse function may not work if an object thin or soft is caught between the sliding sunroof glass and sunroof sash.



#### **WARNING**

Make sure heads, hands, arms or any other body parts or objects are out of the way before operating the sunroof. Body parts or objects may get caught causing injuries or vehicle damage.

Never deliberately use your body parts to test the automatic reversal function. The sunroof glass may reverse direction, but there is a risk of injury.

#### **NOTICE**

- Do not continue to push the sunroof switch after the sunroof is fully opened, closed, or tilted. Damage to the sunroof motor could occur.
- Continuous operations such as slide open/close, tilt open/close, etc. may cause the motor or sunroof system to malfunction.
- Regularly remove any accumulated dust on the sunroof rail.
- Dust accumulated between the sunroof and roof panel can make noise. Open the sunroof and remove dust regularly using a clean cloth.
- Do not try to open the sunroof when the temperature is below freezing or when the sunroof is covered with snow or ice. The sunroof may not work properly and may break if opened by force.
- Do not open or drive with the sunroof glass open immediately after rain or washing the vehicle. Water may wet the interior of the vehicle.
- Do not extend any luggage outside the sunroof while driving. Vehicle damage may occur if the vehicle suddenly stops.



#### **WARNING**

Do not extend your head, arms, body parts or objects outside the sunroof while driving. Injuries may occur if the vehicle suddenly stops.

### Resetting the sunroof



In some circumstances resetting the sunroof operation may need to be performed. Some instances where resetting the sunroof may be required include:

- When the 12-volt battery is either disconnected or discharged
- When the sunroof fuse is replaced
- If the sunroof one-touch AUTO OPEN/CLOSE operation is not functioning properly

Sunroof resetting procedure:

1. It is recommended to perform the reset procedure with the vehicle engine running. Start the vehicle in P (Park).
2. Make sure the sunroof glass is in the fully closed position. If the sunroof glass is open, push the switch forward until the sunroof glass is fully closed.
3. Release the switch when the sunroof glass is fully closed.
4. Push the switch forward until the sunroof glass moves slightly. Then release the switch.
5. Once again push and hold the sunroof switch forward until the sunroof glass slides open and close. Do not release the switch until the operation is completed. If you release the switch during operation, start the procedure again from step 2.

#### Information

**If the sunroof is not reset when the vehicle battery is disconnected or discharged, or the sunroof fuse is blown, the sunroof may not operate normally.**

### Sunroof Open Warning



If the driver turns off the engine when the sunroof is not fully closed, the warning chime will sound for several seconds and the sunroof open warning will appear on the cluster LCD display.

Close the sunroof securely when leaving your vehicle.



#### **CAUTION**

**Make sure the sunroof is closed fully when leaving your vehicle.**

**If the sunroof is left open, rain or snow may wet the interior of the vehicle. Also, leaving the sunroof open when the vehicle is unattended may invite theft.**

## EXTERIOR FEATURES

### Hood

#### Opening the hood



1. Park the vehicle and set the parking brake.
2. Pull the release lever to unlatch the hood. The hood should pop open slightly.

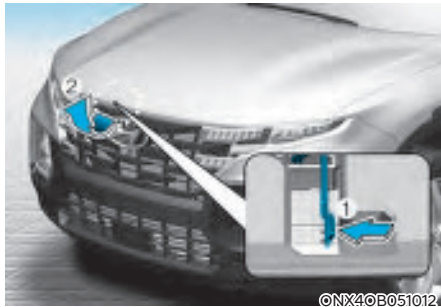

3. Go to the front of the vehicle, raise the hood slightly, push up the secondary latch (1) inside of the hood center and lift the hood.



4. Pull up on the hood support rod.
5. Install the end of the hood support rod into the slot located on the hood (3).

#### **WARNING**

- Grasp the hood support rod in the area wrapped in rubber when the engine is hot. The rubber portion will insulate the heat and protect you from burn or injury.
- The end of the hood support rod must be inserted fully into the hood slot whenever you inspect the engine compartment. This will prevent the hood from falling and possibly injuring you.

### Closing the hood

1. Before closing the hood, check in and around the engine compartment to ensure the following:
  - Any tools or other loose objects are removed from the engine room area or hood opening area
  - All glove, rags, or other combustible material is removed from the engine compartment
  - All filler caps are tightly and correctly installed
2. Return the hood support rod to its clip to prevent it from rattling.
3. Lower the hood until it is about 30 cm (12in.) above the closed position and let it drop. Make sure that it locks into place.
4. Check that the hood has engaged properly. If the hood can be raised slightly, it is not properly engaged. Open it again and close it with a little more force.



### WARNING

- Before closing the hood, ensure all obstructions are removed from around the hood opening.
- Always double check to be sure that the hood is firmly latched before driving away. Check there is no hood open warning light or message displayed on the instrument cluster. Driving with the hood opened may cause a total loss of visibility, which might result in an accident.
- Do not move the vehicle with the hood in the raised position, as vision is obstructed, which might result in an accident, and the hood could fall or be damaged.

### Tailgate

#### Opening the tailgate



©NX4OB051013

Make sure the vehicle is in P (Park) and set the parking brake.

Then do one of the following:

Open the tailgate by pressing the button on the tailgate handle or by pressing the button on the remote key or smart key.

The tailgate is damped and the support cables will hold the tailgate in the open position.

### Closing the tailgate



Close the tailgate by lifting upward and ensure that both latches are properly engaged. This can be checked by pulling back on the gate.

#### **WARNING**

Always keep the tailgate completely closed while the vehicle is in motion.

#### **NOTICE**

To prevent damage to the tailgate support struts and the attached hardware, always close the tailgate before driving.

#### **CAUTION**

Be careful not to put your hands between the tailgate and the pickup bed area when closing the tailgate.

#### **Information**

In cold and wet climates, the tailgate lock mechanism may not operate properly in extreme cold temperatures.

#### **WARNING**



- Ensure that both cables are properly connected and secured before using the tailgate or applying any load on it.
- Do not drive with the tailgate down even at low speeds. This may result in death or personal injury.
- Before opening either by with the handle or remote key or smart key check that no one is in its path of travel.
- When removing the tailgate ensure that the tailgate is placed face up so that no damage can occur to the rear camera.

#### **WARNING**

- Allowing passengers to ride in the pickup bed or on tailgate can result in death or serious injury in a crash. Make sure all passengers ride in a seat and wear a seat belt properly.
- Your vehicle should be kept locked and keys should be kept out of the reach of children. Parents should teach their children about the dangers of playing in luggage compartments.

### Removing the tailgate

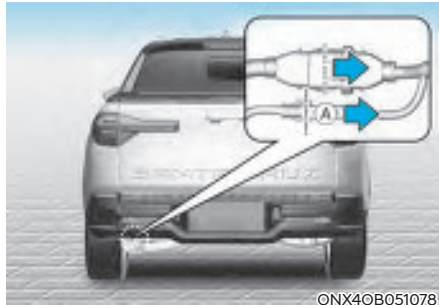

[A] : rear camera connector (If equipped)

1. Disconnect connectors located on the bottom side of the tailgate.

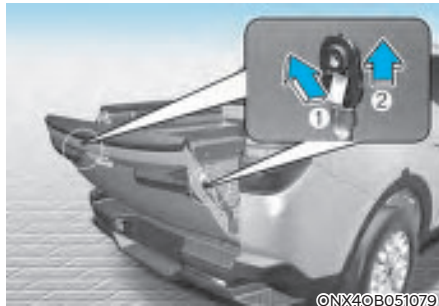

2. Disconnect both support cable. And tilt the tailgate to roughly 45 degrees from the full open position.



3. Pull up the tail gate and out disconnecting the right hand side hinge.



4. Slide the tailgate to the right disconnecting the left hand side hinge. While sliding the tailgate to the right be mindful to avoid potential contact with the rear bumper.

### WARNING

When the connector is disconnected to remove the tailgate, cover the connector with the connector cover enclosed with the owner's manual to prevent moisture infow.

### Rear Bumper Steps



1. Center Step
2. Top Step
3. Corner Step

Use the rear bumper steps shown for easier access to the pickup bed.

#### **NOTICE**

To prevent damage to the rear bumper steps:

- Do not apply more than 330.7lbs. (150 kgf) of weight onto each step.
- Do not jump or bounce on the steps of the bumper.
- Do not allow more than one person to stand on the rear bumper at a time.



#### **CAUTION**

Do not allow others to step or ride on the rear bumper while vehicle is in motion.

### Fuel Filler Door

#### **Opening the fuel filler door**



1. Turn the engine off.
2. Ensure Driver's door is unlocked.
3. Press the rear center edge of the fuel filler door.



4. Pull the fuel filler door (1) outward to access the fuel tank cap.
5. To remove the fuel tank cap (2), turn it counterclockwise. You may hear a hissing noise as the pressure inside the tank equalizes.
6. Place the cap on the fuel filler door.



**i Information**

The fuel filler door will unlock when Driver's door is unlocked.

To unlock fuel filler door:

- Press the unlock button on your remote key or smart key
- Press the Central Door unlock button on armrest trim of driver's door

The fuel filler door will lock when Driver's door is locked.

To lock fuel filler door:

- Press the lock button on your remote key or smart key
- Press the Central Door lock button on armrest trim of driver's door

\* All doors will automatically lock after the vehicle speed exceeds 9 mph. Fuel filler door is also locked when vehicle speed exceeds 9 mph.

**i Information**

If the fuel filler door does not open because ice has formed around it, tap lightly or push on the door to break the ice and release the door. Do not pry on the door. If necessary, spray around the door with an approved deicer fluid (do not use radiator antifreeze) or move the vehicle to a warm place and allow the ice to melt.

**Closing the fuel filler door**

1. To install the fuel tank cap, turn it clockwise until it "clicks" one time.
2. Close the fuel filler door until it is latched securely.

**i Information**

To lock the fuel filler door, make sure the fuel filler door is completely closed. Press the LOCK button on the remote key or smart key to lock your vehicle. The fuel filler door will also lock.

Note that if the fuel filler door is not completely closed when the vehicle is locked, the fuel filler door will not be locked.

**CAUTION**

Make sure the fuel filler door is completely closed before driving through a car wash or operating a high pressure spray washer.

**WARNING**

Automotive fuel is highly flammable and explosive. Failure to follow these guidelines may result in **SERIOUS INJURY** or **DEATH**:

- Read and follow all warnings posted at the gas station.
- Before refueling, note the location of the Emergency Gasoline Shut-Off, if available, at the gas station.
- Before touching the fuel nozzle, you should eliminate the potential build-up of static electricity by touching a metal part of the vehicle, a safe distance away from the fuel filler neck, nozzle, or other gas source, with your bare hand.
- Do not use mobile phones while refueling. Electric current and/or electronic interference from cellular phones can potentially ignite fuel vapors and cause a fire.

- Do not get back into a vehicle once you have begun refueling. You can generate a buildup of static electricity by touching, rubbing or sliding against any item or fabric capable of producing static electricity. Static electricity discharge can ignite fuel vapors causing a fire. If you must re-enter the vehicle, you should once again eliminate potentially dangerous static electricity discharge by touching a metal part of the vehicle, away from the fuel filler neck, nozzle or other fuel source, with your bare hand.
- When using an approved portable fuel container, be sure to place the container on the ground prior to refueling. Static electricity discharge from the container can ignite fuel vapors causing a fire.

Once refueling has begun, contact between your bare hand and the vehicle should be maintained until the filling is complete.

- Use only approved portable plastic fuel containers designed to carry and store fuel.
- When refueling, always shift the gear to the P (Park) position, set the parking brake, and place the ignition switch to the LOCK or Engine Start/ Stop button to OFF position. Sparks produced by electrical components related to the engine can ignite fuel vapors causing a fire.
- Do not use matches or a lighter and do not smoke or leave a lit cigarette in your vehicle while at a gas station, especially during refueling.

- Do not over-fill or top-off your vehicle tank, which can cause gasoline spillage.
- If a fire breaks out during refueling, leave the vicinity of the vehicle, and immediately contact the manager of the gas station and then contact the local fire department. Follow any safety instructions they provide.
- If pressurized fuel sprays out, it can cover your clothes or skin and thus subject you to the risk of fire and burns. Always remove the fuel cap carefully and slowly. If the cap is venting fuel or if you hear a hissing sound, wait until the condition stops before completely removing the cap.
- Always check that the fuel cap is installed securely to prevent fuel spillage in the event of an accident.

### Information

Make sure to refuel your vehicle according to the “Fuel Requirements” section in suggested in chapter 1.

### **NOTICE**

- Do not spill fuel on the exterior surfaces of the vehicle. Any type of fuel spilled on painted surfaces may damage the paint.
- If the fuel filler cap requires replacement, use only a genuine HYUNDAI cap or the equivalent specified for your vehicle. An incorrect fuel filler cap can result in a serious malfunction of the fuel system or emission control system.

## LIGHTING

### Exterior Lights

#### Lighting control

To operate the lights, turn the knob at the end of the control lever to one of the following positions:



ONX4OB051032

1. OFF position
2. AUTO headlamp position
3. Position lamp position
4. Headlamp position

#### Daytime Running Light (DRL)

The Daytime Running Lights (DRL) can make it easier for others to see the front of your vehicle during the day, especially after dawn and before sunset. The Daytime Running Lights (DRL) should be illuminated whenever you are driving during daylight hours. The DRL system will be ON when the headlamp stalk is in the OFF or the AUTO Position (when daylight is detected) and the Electronic Parking Brake (EPB) is released.

The DRL system will turn off when:

- The headlamps are ON.
- The parking brake is applied.
- The vehicle is turned off.

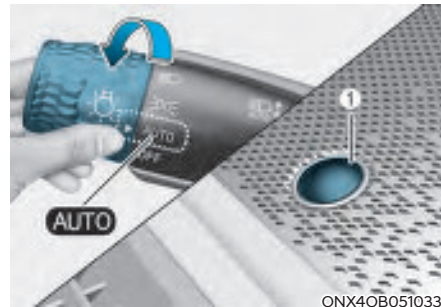

ONX4OB051033

#### AUTO headlamp position

The position lamp and headlamp will be turned ON or OFF automatically depending on the amount of daylight as measured by the ambient light sensor (1) at the upper end of the dash board.

Even with the AUTO headlamp feature in operation, it is recommended to manually turn ON the headlamps when driving at night or in a fog, driving in the rain, or when you enter dark areas, such as tunnels and parking facilities.

#### NOTICE

- **Do not cover or spill anything on the sensor (1) located at the upper end of the dash board.**
- **Do not clean the sensor using a window cleaner, the cleanser may leave a light film which could interfere with sensor operation.**
- **If your vehicle has window tint or other types of metallic coating on the front windshield, the AUTO headlamp system may not work properly.**



ONX4OB051034

**Position lamp position (☞☞)**

The position lamp, license plate lamp and instrument panel lamp are turned ON.



ONX4OB051035

**Headlamp position (☞☞)**

The headlamp, position lamp, license plate lamp and instrument panel lamp are turned ON.

**i Information**

The ignition switch must be in the ON position to turn on the headlamp.

**High beam operation**



ONX4OB051036

To turn on the high beam headlamp, push the lever away from you. The lever will return to its original position.

The high beam indicator will light when the headlamp high beams are switched on.

To turn off the high beam headlamp, pull the lever towards you. The low beams will turn on.

**⚠ WARNING**

Do not use high beam when there are other vehicles approaching you. Using high beam could obstruct the other driver's vision.



ONX4OB051037

To flash the high beam headlamp, pull the lever towards you, then release the lever. The high beams will remain ON as long as you hold the lever towards you.

### Turn signals and lane change signals

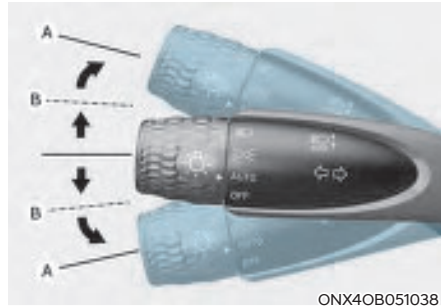

To signal a turn, push down on the lever for a left turn or up for a right turn in position (A).

If an indicator stays on and does not flash or if it flashes abnormally, one of the turn signal bulbs may be burned out and will require replacement.

#### One touch turn signal

To use One Touch Turn Signal push the turn signal lever up or down to position (B) and then release it.

The lane change signals will blink 3, 5 or 7 times.

You can enable the One Touch Turn Signal function or choose the number of blinking by selecting 'Setup → User Settings → Lights → One Touch Turn Signal → Off/3 flashes/5 flashes/7 flashes' in the instrument panel LCD cluster.

### Battery saver function

The purpose of this feature is to prevent the battery from being discharged.

The system automatically turns off the position lamp when the driver turns the vehicle off and opens the driver-side door.

With this feature, the position lamps will turn off automatically if the driver parks on the side of road at night.

However, the position lamps stay ON even when the driver-side door is opened if the headlamp switch is turned to the position lamp or AUTO (if equipped) position after the engine is turned off.

If necessary, to keep the lamps on turn the position lamps OFF and ON again using the headlamp switch on the steering column after the engine is turned off.

### ***Headlamp delay function***

If you place the ignition switch to the ACC position or the OFF position with the headlamps ON, the headlamps (and/or position lamps) remain on for about 5 minutes. However, if the driver's door is opened and closed, the headlamps are turned off after 15 seconds. Also, with the vehicle off if the driver's door is opened and closed, the headlamps (and/or position lamps) are turned off after 15 seconds.

The headlamps (and/or position lamps) can be turned off by pressing the lock button on the remote key or smart key twice or turning the headlamp switch to the OFF or AUTO position.

You can enable the headlamp delay function by selecting 'Setup → User Settings → Lights → Headlight Delay.

### **NOTICE**

**If the driver exits the vehicle through another door besides the driver door, the battery saver function does not operate and the headlamp delay function does not turn OFF automatically.**

**This may cause the battery to discharge. To avoid battery discharge, turn OFF the headlamps manually from the headlamp switch before exiting the vehicle.**

## HIGH BEAM ASSIST (HBA)



ODN8059206

High Beam Assist will automatically switch between high beam and low beam depending on the detected brightness from the lamps of oncoming vehicles or vehicles in front.

### Detecting sensor



©NX40B051017

[1] : Front view camera

The front view camera is used as a detecting sensor to detect ambient light and brightness while driving.

Refer to the picture above for the detailed location of the detecting sensor.

### NOTICE

- Always keep the front view camera in good condition to maintain optimal performance of High Beam Assist.
- For more details on the precautions of the front view camera, refer to “Forward Collision-Avoidance Assist (FCA)” section in chapter 7.

### High Beam Assist Settings

With the engine on, select 'Lights → High Beam Assist' from the Settings menu to turn on High Beam Assist and deselect to turn off the function.



### WARNING

For your safety, change the Settings after parking the vehicle at a safe location.

## High Beam Assist Operation

### Display and control

- After selecting 'High Beam Assist' in the Settings menu, High Beam Assist will operate by following the procedure below.
  - Place the headlamp switch in the AUTO position and push the headlamp lever towards the instrument cluster. The High Beam Assist (AUTO) indicator light will illuminate on the cluster and the function will be enabled.
  - When the function is enabled, high beam will turn on when vehicle speed is above 25mph (40km/h). When vehicle speed is below 15 mph (25 km/h), high beam will turn off.
  - The High Beam (H) indicator light will illuminate on the cluster when high beam is on.
- When High Beam Assist is operating, if the headlamp lever or switch is used, the function operates as follow:
  - If the headlamp lever is pulled towards you when the high beam is off, the high beam will turn on without High Beam Assist canceled. When you let go of the headlamp lever, the lever will move to the middle and the high beam will turn off.
  - If the headlamp lever is pulled towards you when the high beam is on by High Beam Assist, low beam will turn on and the function will turn off.
  - If the headlamp switch is placed from AUTO to another position (headlamp/position/off), High Beam Assist will turn off and the corresponding lamp will turn on.
- When High Beam Assist is operating, high beam switches to low beam if any of the following conditions occur:
  - When the headlamp of an oncoming vehicle is detected.
  - When the tail lamp of a vehicle in front is detected.
  - When the headlamp or tail lamp of a motorcycle or a bicycle is detected.
  - When the surrounding ambient light is bright enough that high beams are not required.
  - When streetlights or other lights are detected.

### Information

- **The images and colors in the cluster may differ depending on the cluster type or theme selected from the cluster.**



## High Beam Assist Malfunction and Limitations

### High Beam Assist malfunction

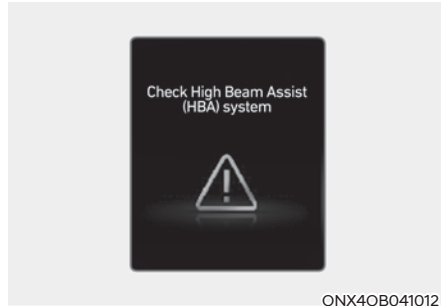

When High Beam Assist is not working properly, the 'Check High Beam Assist (HBA) system' warning message will appear and  warning light will illuminate on the cluster. Have the vehicle inspected by an authorized HYUNDAI dealer.

### Limitations of High Beam Assist

High Beam Assist may not work properly in the following situations:

- Light from an oncoming or front vehicle is not detected because of lamp damage, or because it is hidden from sight, etc.
- Head lamp of an oncoming or front vehicle is covered with dust, snow or water.
- An oncoming or front vehicle's headlamps are off but the fog lamps are on, etc.
- There is a lamp that has a similar shape as a vehicle's lamp.
- Headlamps have been damaged or not repaired properly.
- Headlamps are not aimed properly.
- Driving on a narrow curved road, curved road, rough road, uphill or downhill.
- Vehicle in front is partially visible on a crossroad or curved road.
- There is a traffic light, reflecting sign, flashing sign or mirror ahead.
- There is a temporary reflector or flash ahead (construction area).
- The road conditions are bad such as being wet, iced or covered with snow.
- A vehicle suddenly appears from a curve.
- The vehicle is tilted from a flat tire or is being towed.
- Light from an oncoming or front vehicle is not detected due to obstacles in the air such as exhaust fume, smoke, fog, snow, or water spray or blizzard on the road, or fogging in the lamp, etc.

### Information

For more details on the limitations of the front view camera, refer to "Forward Collision-Avoidance Assist (FCA)" section in chapter 7.

### WARNING

- **At times, High Beam Assist may not work properly. It is the responsibility of the driver for safe driving practices and always check the road conditions for your safety.**
- **When High Beam Assist does not operate normally, change the headlamp position manually between high beam and low beam.**

## INTERIOR LIGHTS

### WARNING

Do not use the interior lights when driving in the dark. The interior lights may obscure your view and cause an accident.

### NOTICE

Do not use the interior lights for extended periods when the vehicle is turned off or the battery will discharge.

### Interior Lamp AUTO OFF

The interior lamps will automatically go off approximately 10 minutes after the vehicle is turned off and the doors are closed. If a door is opened, the lamp will go off 40 minutes after the vehicle is turned off. If the doors are locked by the smart key and the vehicle enters the armed stage of the theft alarm system, the lamps will go off five seconds later.

## Front Lamps



### 1. Front map lamp ( ):

Touch either lenses to turn the map lamp on or off. This light produces a spot beam for convenient use as a map lamp at night or as a personal lamp for the driver and the front passenger.

### 2. Door lamp ():

The front or rear room lamps come on when the front or rear doors are opened. When doors are unlocked by the smart key, the front and rear lamps come on for approximately 30 seconds as long as any door is not opened. The front and rear room lamps go out gradually after approximately 30 seconds when the door is closed. However, if the ignition switch or the Engine Start/Stop button is in the ON position or all doors are locked, the front and rear lamps will turn off. If a door is opened with the ignition switch in the ACC position or the OFF position, the front and rear lamps will stay on for about 20 minutes.

### 3. Room lamp ()

Press the button to turn ON the room lamp for the front/rear seats.

## Rear Lamps

■ Type A



■ Type B



### Rear room lamp switch :

Press this button to turn the room lamp on and off.

## Vanity Mirror Lamp



Push the switch to turn the light on or off.

- ☀️ : The lamp will turn on if this button is pressed.
- ○ : The lamp will turn off if this button is pressed.

### Glove Box Lamp (if equipped)

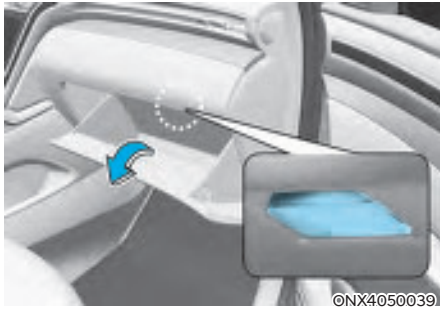

The glove box lamp turns on when the glove box is opened.

### Welcome System (if equipped)



Welcome system helps keep the driver visible by turning on vehicle lights when the driver approaches the vehicle.

### Door Handle Lamp (if equipped)

When all the doors are closed and locked, the door handle lamp will turn on for approximately 15 seconds if any of the below is performed.

- If 'Convenience → Welcome mirror/light → On door unlock' is selected in the User Settings mode on the LCD display,
  - the lamps will turn on when the door lock button is pressed on the smart key.
  - the lamps will turn on when the button of the outside door handle is pressed with the smart key in possession. (available with button type)
  - the lamps will turn on when the touch sensor on the outside door handle is touched with the smart key in possession. (available with touch sensor type)
- If both 'Convenience → Welcome mirror/light → On door unlock' and 'Convenience → Welcome mirror/light → On driver approach' is selected in the User Settings mode on the LCD display, the lamps will turn on when the vehicle is approached with the smart key in possession.

You can activate or deactivate Welcome Light function from the User Settings mode on the LCD display.

**Headlamp and position lamp**

When the headlamp (lamp switch in the headlamp or AUTO position) is on and all doors (and tailgate) are locked and closed, the position lamp and headlamp will come on for 15 seconds when the door unlock button is pressed on the remote key or smart key.

At this time, if you press the door lock or unlock button, the position lamp and headlamp will turn off immediately.

**Interior lamp**

When the interior lamp switch is in the  position and all doors (and tailgate) are closed and locked, the room lamp will come on for 30 seconds if any of the below is performed.

- When the door unlock button is pressed on the remote key or smart key.
- When you put your hand in the outside door handle while carrying the smart key.

At this time, if you press the door lock or unlock button on the smart key the lamps will turn off immediately.

**Top mounted bed lamp and Side mounted bed lamp (if equipped)**

Lamps will be activated when a button in cabin is pressed once. (Indicator on button will illuminate when lamps are on.) Or when underbed storage lid is opened.

Lamps will turn Off if any of the following occur:

- After 10 minutes of being activated.
- When remote key or smart key lock button is pressed twice.
- When underfloor storage lid is closed securely.

**NOTICE**

**Bed lamps can only be activated when vehicle is in Park (P) or Neutral (N) with the vehicle speed is below 3.1 mph (5 km/h).**

## WIPERS AND WASHERS



- A. Wiper speed control
- MIST – Single wipe
  - OFF – Off
  - INT – Intermittent wipe
  - AUTO – Auto control wipe (if equipped)
  - LO– Low wiper speed
  - HI – High wiper speed
- B. Intermittent control wipe time adjustment
- C. Wash with brief wipes

### Windshield Wipers

Operates as follows when the ignition switch is turned ON.

**MIST :** For a single wiping cycle, move the lever up and release it. The wipers will operate continuously if the lever is held in this position.

**OFF :** Wipers are not in operation.

**INT :** Wipers operate intermittently at the same wiping intervals. Use this mode in light rain or mist. To vary the speed setting, turn the speed control knob.

**LO :** The wiper runs at a lower speed.

**HI :** The wiper runs at a higher speed.

### **i** Information

**If there is heavy accumulation of snow or ice on the windshield, defrost the windshield for about 10 minutes, or until the snow and/or ice is removed before using the windshield wipers to ensure proper operation.**

**If you do not remove the snow and/or ice before using the wiper and washer, it may damage the wiper and washer system.**

**AUTO Wiper Control (if equipped)**

The rain sensor located on the upper end of the windshield glass senses the amount of rainfall and controls the wiping cycle for the proper interval.

The wiper operation time will be automatically controlled depends on rainfall.

When the rain stops, the wiper stops.

To vary the sensitivity setting, turn the sensitivity control knob.

If the wiper switch is set in AUTO mode when the ignition switch is in the ON position, the wiper will operate once to perform a self-check of the system. Set the wiper to the OFF position when the wiper is not in use.

**⚠ WARNING**

To avoid personal injury from the windshield wipers, when the engine is running and the windshield wiper switch is placed in the AUTO mode:

- Do not touch the upper end of the windshield glass facing the rain sensor.
- Do not wipe the upper end of the windshield glass with a damp or wet cloth.
- Do not put pressure on the windshield glass.

**NOTICE**

- When washing the vehicle, set the wiper switch in the OFF position to stop the auto wiper operation. The wiper may operate and be damaged if the switch is set in the AUTO mode while washing the vehicle.
- Do not remove the sensor cover located on the upper end of the passenger side windshield glass. Damage to system components could occur and may not be covered by your vehicle warranty.
- Because of using a photo sensor, temporary malfunction could occur according to sudden ambient light change made by stone and dust while driving.

## Windshield Washers



In the OFF position, pull the lever gently toward you to spray washer fluid on the windshield and to run the wipers 1-3 cycles. The spray and wiper operation will continue until you release the lever. If the washer does not work, you may need to add washer fluid to the washer fluid reservoir.

### **WARNING**

When the outside temperature is below freezing, **ALWAYS** warm the windshield using the defroster to help prevent the washer fluid from freezing on the windshield and obscuring your vision which could result in an accident and serious injury or death.

### **NOTICE**

- To prevent possible damage to the washer pump, do not operate the washer when the fluid reservoir is empty.
- To prevent possible damage to the wipers or windshield, do not operate the wipers when the windshield is dry.
- To prevent damage to the wiper arms and other components, do not attempt to move the wipers manually.
- To prevent possible damage to the wipers and washer system, use anti-freezing washer fluids in the winter season or cold weather.



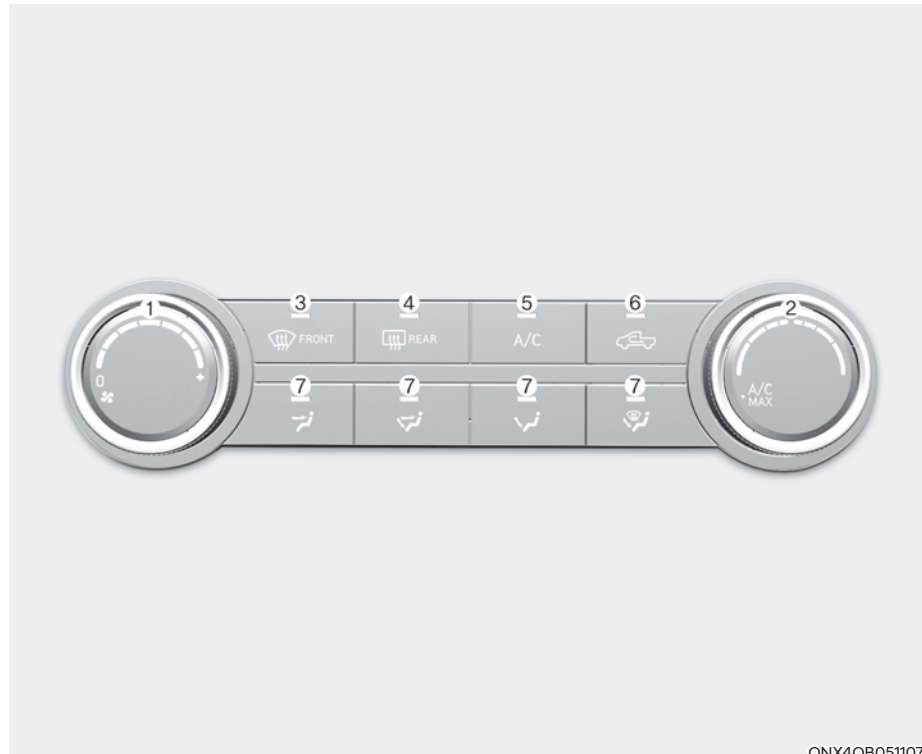

**MANUAL CLIMATE CONTROL SYSTEM (IF EQUIPPED)**

1. Fan speed control knob
2. Temperature control knob
3. Front windshield defroster button
4. Rear window defroster button
5. A/C (air conditioning) button
6. Air intake control button
7. Mode selection button

### Heating and Air Conditioning

1. Start the engine.
2. Set the mode to the desired position.

To improve the effectiveness of heating and cooling, select:

- Heating: 
- Cooling: 

3. Set the temperature control to the desired position.
4. Set the air intake control to the outside (fresh) air position.
5. Set the fan speed control to the desired speed.
6. If air conditioning is desired, turn the air conditioning system on.

### Mode selection

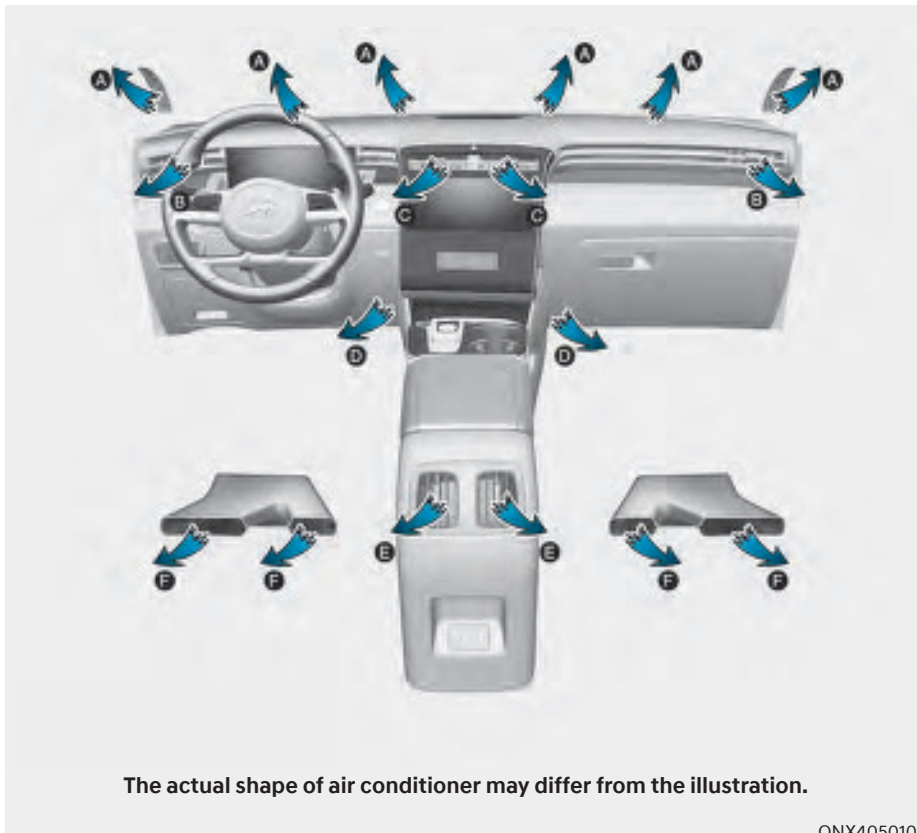

ONX4050102

The mode selection button controls the direction of the air flow through the ventilation system.

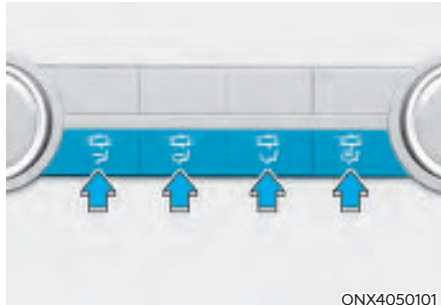

ONX4050101

**Face-Level (B, C, E)**

Air flow is directed toward the upper body and face. Additionally, each outlet can be controlled to direct the air discharged from the outlet.

**Bi-Level (B, C, D, E, F)**

Air flow is directed towards the face and the floor.

**Floor-Level (A, B, D, E, F)**

Most of the air flow is directed to the floor, with a small amount of the air being directed to the windshield and side window defrosters.

**Floor/Defrost-Level (A, B, D, E, F)**

Most of the air flow is directed to the floor and the windshield with a small amount directed to the side window defrosters.

**Front defroster (A, B)**

Most of the air flow is directed to the windshield with a small amount of air directed to the side window defrosters.

**MAX A/C-Level (B, C, E)**

ONX4E050153

The MAX A/C mode is used to cool the inside of the vehicle faster. Air flow is directed toward the upper body and face.

In this mode, the air conditioning and the recirculated air position is selected. Turn the fan speed mode to adjust.

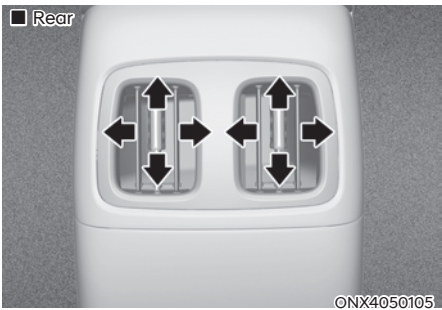
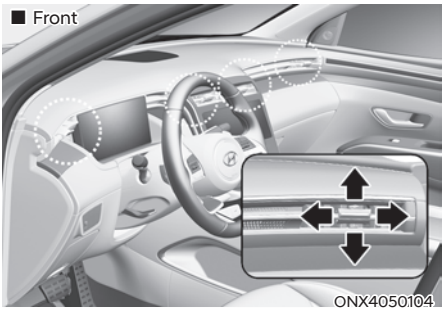

**Instrument panel vents**

The instrument panel vent air flow can be directed up/down or left/right using the vent adjustment lever. The air flow can also be CLOSED using the vent adjustment lever.

**Temperature control**



The temperature will increase by turning the knob to the right. The temperature will decrease by turning the knob to the left.

**Air intake control**

This is used to select outside (fresh) air position or recirculated air position. To change the air intake control position, press the control button.

**Recirculated air position**



With the recirculated air position selected, air from the passenger compartment will be drawn through the heating system and heated or cooled according to the function selected.

**Outside (fresh) air position**



With the outside (fresh) air position selected, air enters the vehicle from outside and is heated or cooled according to the function selected.

### **i** Information

Using the system in the fresh air position is recommended.

Prolonged operation of the heater in the recirculated air position (without air conditioning selected) can cause fogging of the windshield and side windows and the air within the passenger compartment will become stale.

In addition, prolonged use of the air conditioning with the recirculated air position selected will result in excessively dry air in the passenger compartment.

### **!** WARNING

- Continued climate control system operation in the recirculated air position may allow humidity to increase inside the vehicle which may fog the glass and obscure visibility.
- Do not sleep in a vehicle with the air conditioning or heating system on. It may cause serious harm or death due to a drop in the oxygen level and/or body temperature.
- Continued climate control system operation in the recirculated air position can cause drowsiness or sleepiness, and loss of vehicle control. Set the air intake control to the outside (fresh) air position as much as possible while driving.

### *Fan speed control*



Turn the knob to the right to increase the fan speed and airflow. Turn the knob to the left to decrease fan speed and airflow.

Setting the fan speed control knob to the "0" position turns off the fan.

### **NOTICE**

Operating the fan speed when the ignition switch is in the ON position could cause the battery to discharge. Operate the fan speed when the engine is running.

### *Air conditioning (A/C) (if equipped)*



Press the A/C button to turn the air conditioning system on (indicator light will illuminate). Press the button again to turn the air conditioning system off.



### System Operation

#### Ventilation

1. Set the mode to the  position.
2. Set the air intake control to the outside (fresh) air position.
3. Set the temperature control to the desired position.
4. Set the fan speed control to the desired speed.

#### Heating

1. Set the mode to the  position.
2. Set the air intake control to the outside (fresh) air position.
3. Set the temperature control to the desired position.
4. Set the fan speed control to the desired speed.
5. If desired, turn the air conditioning ON with the temperature control knob set to heat in order to dehumidify the air before it enters into the cabin.

If the windshield fogs up, set the mode to the  or  position.

#### Operation Tips

- To help keep dust or unpleasant fumes from entering the vehicle through the ventilation system, temporarily set the air intake control to the recirculated air position. Be sure to return the control to the fresh air position when the irritation has passed to keep fresh air in the vehicle. This will help keep the driver alert and comfortable.
- To prevent interior fog on the windshield, set the air intake control to the fresh air position and fan speed to the desired position, turn on the air conditioning system, and adjust the temperature control to the desired temperature.

#### Air conditioning

HYUNDAI Air Conditioning Systems are filled with R-1234yf refrigerant.

1. Start the vehicle.
2. Press the air conditioning button.
3. Set the mode to the Face Level  mode.
4. Set the air intake control to Recirculation mode temporarily to allow the cabin to cool quickly. When the desired temperature in the cabin is reached, change the air intake control back to Fresh mode.
5. Adjust the fan speed control and temperature control to maintain maximum comfort.

When maximum cooling is desired, set the temperature control to the lowest position, then set the fan speed control to the highest setting.

#### NOTICE

- **When using the air conditioning system, monitor the engine temperature gauge closely while driving up hills or in heavy traffic when outside temperatures are high. Air conditioning system operation when climbing a steep grade or in high outside ambient temperatures can cause engine overheating. Continue to use the fan, but turn the air conditioning system off if the engine temperature gauge indicates engine overheating.**
- **The air conditioning evaporator (cooling coil) shall never be repaired or replaced with one removed from a used or salvaged vehicle and new replacement MAC evaporators shall be certified (and labeled) as meeting SAE Standard J2842.**

#### Air conditioning system operation tips

- If the vehicle has been parked in direct sunlight during hot weather, open the windows for a short time to let the hot air inside the vehicle escape.
- After sufficient cooling has been achieved, switch back from the recirculated air to the fresh outside air position.
- To help reduce moisture inside of the windows on rainy or humid days, decrease the humidity inside the vehicle by operating the air conditioning system with the windows and sunroof closed.
- Use the air conditioning system every month for a few minutes to ensure maximum system performance.
- If you operate the air conditioner excessively, the difference between the temperature of the outside air and that of the windshield could cause the outer surface of the windshield to fog up, causing loss of visibility. In this case, set the mode selection knob to the  position and set the fan speed control knob to the lowest speed setting.

#### System Maintenance

##### Cabin air filter

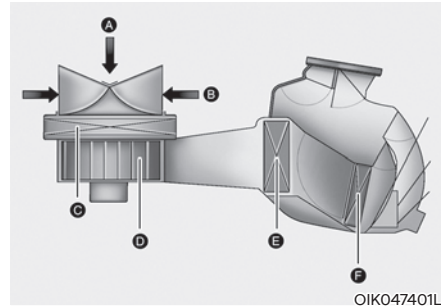

[A] : Outside air, [B] : Recirculated air  
 [C] : Cabin air filter, [D] : Blower  
 [E] : Evaporator core, [F] : Heater core

The cabin air filter is installed behind the glove box. It filters the dust or other pollutants that enter the vehicle through the heating and air conditioning system.

Have the cabin air filter replaced by an authorized HYUNDAI dealer according to the maintenance schedule.

If the vehicle is being driven in severe conditions such as dusty or rough roads, more frequent climate control filter inspections and changes are required.

If the air flow rate suddenly decreases, the system should be checked at an authorized HYUNDAI dealer.

### **Air Conditioning Performance and Maintenance at Your HYUNDAI Dealer**

When the amount of refrigerant is low, the performance of the air conditioning is reduced. Overfilling also reduces the performance of the air conditioning system. Therefore, if abnormal operation is found, have the system inspected by an authorized HYUNDAI dealer.

#### **NOTICE**

**It is important that the correct type and amount of oil and refrigerant is used. Otherwise, damage to the compressor and abnormal system operation may occur. To prevent damage, the air conditioning system in your vehicle should only be serviced by trained and certified technicians.**



#### **WARNING**

Vehicles equipped with R-1234yf



**Since the refrigerant is mildly flammable and operated at high pressure, the air conditioning system should only be serviced by trained and certified technicians. It is important that the correct type and amount of oil and refrigerant are used.**

**All refrigerants should be reclaimed with proper equipment. Venting refrigerants directly to the atmosphere is harmful to individuals and environment. Failure to heed these warnings can lead to serious injuries.**



#### **Air Conditioning refrigerant label**

You can find out which air conditioning refrigerant is applied to your vehicle on the label located inside of the hood.

#### **Example**

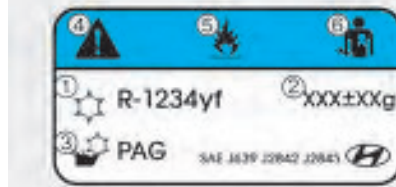

OHYK059001

Each symbol and specification on the air conditioning refrigerant label is represented as below:

1. Classification of refrigerant
2. Amount of refrigerant
3. Classification of compressor lubricant
4. Caution
5. Flammable refrigerant
6. To require registered technician to service air conditioning system



## AUTOMATIC CLIMATE CONTROL SYSTEM (IF EQUIPPED)

### ■ Type A



### ■ Type B



The actual shape of air conditioner may differ from the illustration.

ONX4OB051100/ONX4OB051101

- |   |  |
|---|--|
| 1. Driver's temperature control button/<br>knob   | 7. A/C (air conditioning) button       |
| 2. Passenger's temperature control<br>button/knob | 8. Fan speed control button            |
| 3. AUTO (automatic control) button                | 9. Mode selection button               |
| 4. Air intake control button                      | 10. Multi Air Mode button              |
| 5. OFF button                                     | 11. Rear window defroster button       |
| 6. Front windshield defroster button              | 12. SYNC button                        |
|   | 13. Climate control information screen |

## Automatic Heating and Air Conditioning

The Automatic Climate Control System is controlled by setting the desired temperature.

1. Press the AUTO button.

The modes, fan speeds, air intake and air-conditioning will be controlled automatically by the temperature setting you select.

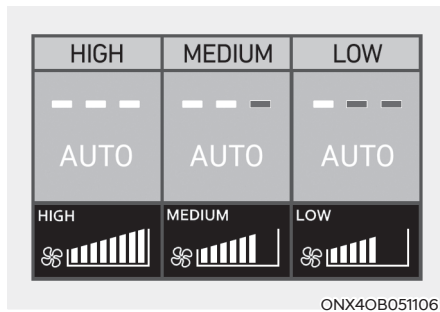

You can control the fan speed in three stages by pushing the AUTO button during automatic operation.

- HIGH : Provide rapid air conditioning and heating with maximum fan speed setting
- MEDIUM : Provide air conditioning and heating with mid-level fan speed setting
- LOW : Fan speed is set to the lowest setting range

2. Turn the temperature control button/knob to set the desired temperature. If the temperature is set to the lowest setting (Lo), the air conditioning system will operate continuously. After the interior has cooled sufficiently, adjust the button/knob to a higher temperature set point whenever possible.

To turn the automatic operation off, select any button of the following:

- Mode selection button
  - Front windshield defroster button (Press the button one more time to deselect the front windshield defroster function. The 'AUTO' sign will illuminate on the information display once again.)
  - Fan speed control button
- The selected function will be controlled manually while other functions operate automatically.

For your convenience and to improve the effectiveness of the climate control, use the AUTO button and set the temperature to 72°F (22°C).



**i** Information

Never place anything near the sensor to ensure better control of the heating and cooling system.

### Manual Heating and Air Conditioning

1. Start the engine.
2. Set the mode to the desired position.  
For improving the effectiveness of heating and cooling, select:
  - Heating:
  - Cooling:
3. Set the temperature control to the desired position.
4. Set the air intake control to the outside (fresh) air position.
5. Set the fan speed control to the desired speed.
6. If air conditioning is desired, turn the air conditioning system on.
7. Press the AUTO button to convert to full automatic control of the system.

**Mode selection (12)**

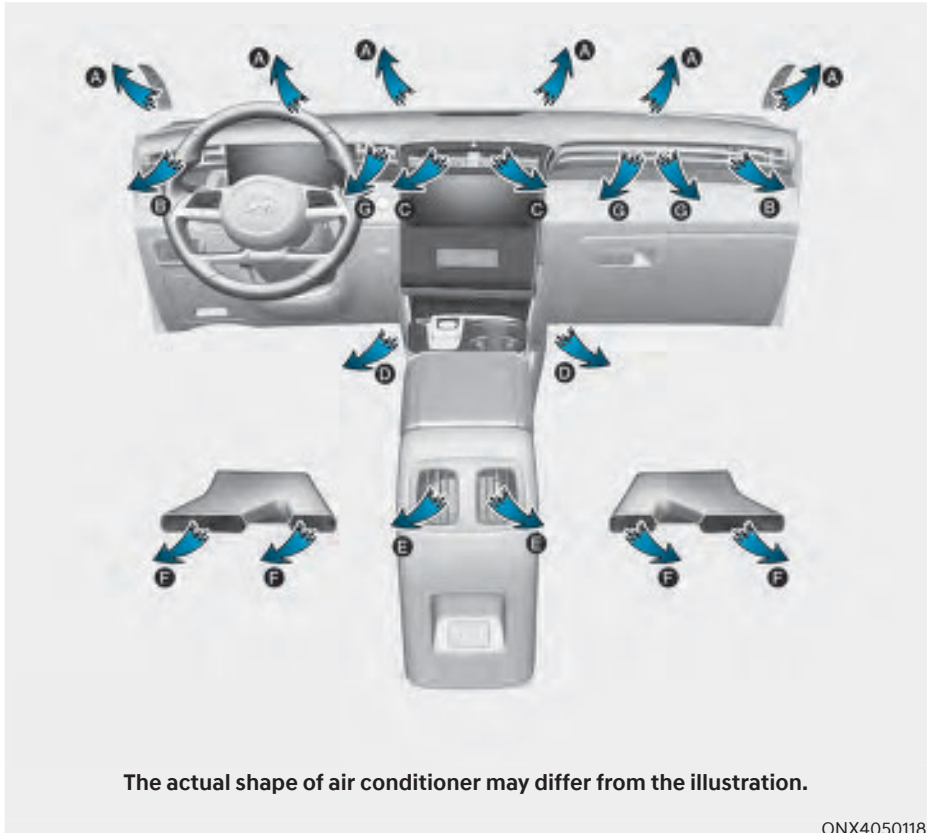

ONX4050118

The mode selection button controls the direction of the air flow through the ventilation system.



The air flow outlet direction is cycled as follows:



#### Face-Level (B, C, E)

Air flow is directed toward the upper body and face. Additionally, each outlet can be controlled to direct the air discharged from the outlet.

#### Bi-Level (B, C, D, E, F)

Air flow is directed towards the face and the floor.

#### Floor-Level (A, B, D, E, F)

Most of the air flow is directed to the floor, with a small amount of the air being directed to the windshield and side window defrosters.

#### Floor/Defrost-Level (A, B, D, E, F)

Most of the air flow is directed to the floor and the windshield with a small amount directed to the side window defrosters.

#### FRONT Defrost-Level (A, B)

Most of the air flow is directed to the windshield with a small amount of air directed to the side window defrosters.

#### Multi air mode (B, C, D, E, F, G) DIFFUSE

Gentle breezes come out the outlet vents.

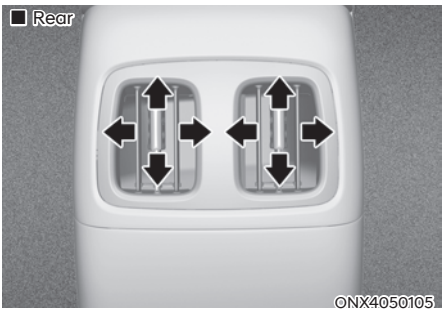
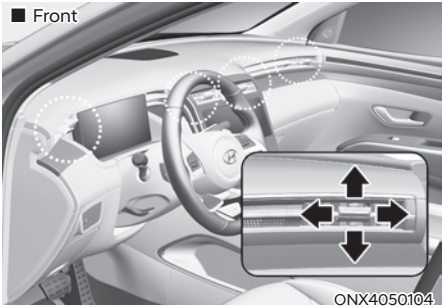

**Instrument panel vents**

The instrument panel vent air flow can be directed up/down or left/right using the vent adjustment lever. The air flow can also be CLOSED using the vent adjustment lever.

**Temperature control**

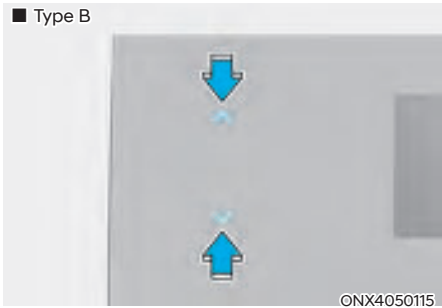

The temperature setting will increase when you toggle up or touch the UP arrow on the touchscreen (if equipped). The temperature setting will decrease when you toggle down or touch the DOWN arrow on the touchscreen (if equipped).



#### Adjusting the temperature equally

Press the SYNC button (indicator light ON) to adjust the driver and passenger side and the rear seat's temperature equally.

#### Adjusting the temperature and individually

Press the SYNC button (indicator light OFF) again to adjust the driver and passenger side and the rear seat's temperature individually.

#### Temperature conversion

If the battery has been discharged or disconnected, the temperature mode display will reset to Fahrenheit.

To change the temperature unit from °C to °F or °F to °C :

- Instrument cluster or infotainment system screen

Go to Setup→ Unit → Temperature unit

The temperature unit on both the cluster LCD display and the climate control screen will change.

#### Air intake control

The air intake control button is used to select either Fresh mode (outside air) or Recirculation mode (cabin air).

#### Recirculated air position



With the recirculated air position selected, air from the passenger compartment will be drawn through the heating system and heated or cooled according to the function selected.

#### Outside (fresh) air position



With the outside (fresh) air position selected, air enters the vehicle from outside and is heated or cooled according to the function selected.

**i** Information

Using the system in the fresh air position is recommended.

Prolonged operation of the heater in the recirculated air position (without air conditioning selected) can cause fogging of the windshield and side windows and the air within the passenger compartment will become stale.

In addition, prolonged use of the air conditioning with the recirculated air position selected will result in excessively dry air in the passenger compartment.

**⚠** WARNING

- Continued climate control system operation in the recirculated air position may allow humidity to increase inside the vehicle which may fog the glass and obscure visibility.
- Do not sleep in a vehicle with the air conditioning or heating system on. It may cause serious harm or death due to a drop in the oxygen level and/or body temperature.
- Continued climate control system operation in the recirculated air position can cause drowsiness or sleepiness, and loss of vehicle control. Set the air intake control to the outside (fresh) air position as much as possible while driving.

**Fan speed control**



ONX4050124

The fan speed can be set as desired by pushing the fan speed control button. Increased air flow is delivered with higher fan speeds. Pressing the OFF button turns off the fan.

**NOTICE**

Operating the fan when the ignition switch is in the ON position could cause the battery to discharge. Operate the fan when the engine is running.

**Air conditioning**



Push the A/C button to turn the air conditioning system on (indicator light will illuminate).

Push the button again to turn the air conditioning system off.

**OFF mode**



Push the OFF button to turn the climate control system off. However, you can still operate the mode and air intake buttons as long as the ignition switch is in the ON position.



### Multi Air Mode (if equipped)

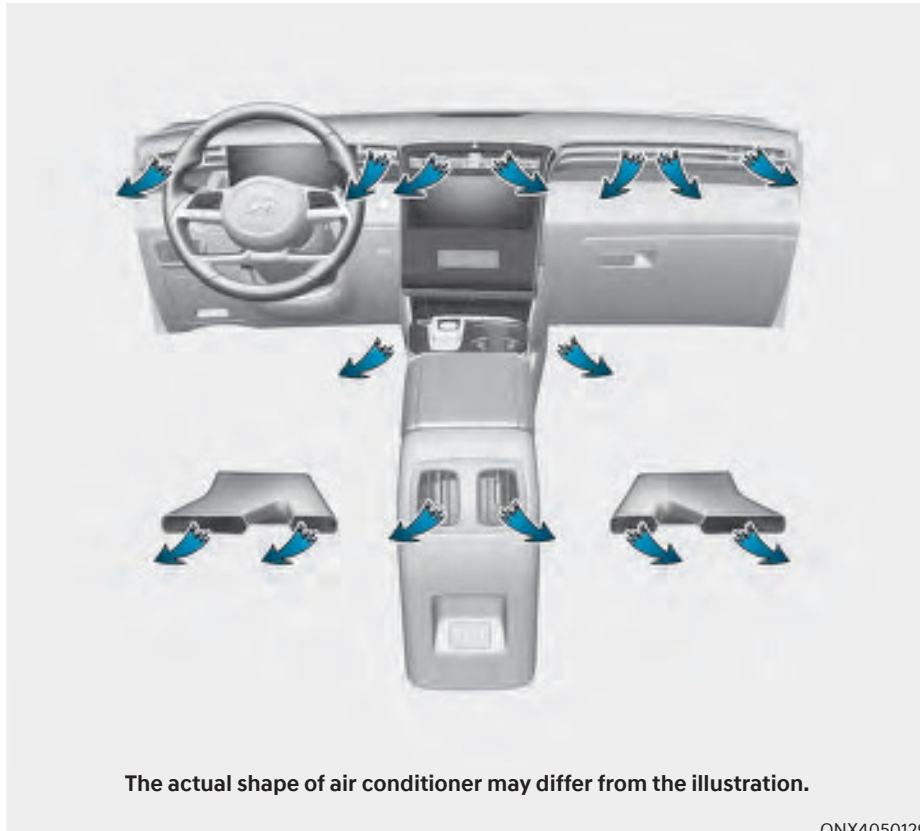



### **ON**

When the Multi-Air mode button is pressed, air flow is directed to the face level and floor level and through perforated sections along the instrument panel for the driver and passenger. The multi-air mode LED indicator will be illuminated. If the multi air mode button is pressed when the air volume is beyond level 4, it decreases to Level 3.

### **OFF**

If you press the multi-air button again, the indicator will turn OFF and the directed air flow will be according to the previous setting before multi-air mode was enabled.

If you press the MODE selection button, the airflow will change based on the MODE selected.

## System Operation

### **Ventilation**

1. Set the mode to the  position.
2. Set the air intake control to the outside (fresh) air position.
3. Set the temperature control to the desired position.
4. Set the fan speed control to the desired speed.

### **Heating**

1. Set the mode to the  position.
2. Set the air intake control to the outside (fresh) air position.
3. Set the temperature control to the desired position.
4. Set the fan speed control to the desired speed.
5. If desired, turn the air conditioning ON with the temperature control knob set to heat in order to dehumidify the air before it enters into the cabin.

If the windshield fogs up, set the mode to the  or  position.

### Operation Tips

- To help keep dust or unpleasant fumes from entering the vehicle through the ventilation system, temporarily set the air intake control to the recirculated air position. Be sure to return the control to the fresh air position when the irritation has passed to keep fresh air in the vehicle. This will help keep the driver alert and comfortable.
- To prevent interior fog on the windshield, set the air intake control to the fresh air position and fan speed to the desired position, turn on the air conditioning system, and adjust the temperature control to the desired temperature.

1. Start the vehicle.
2. Press the air conditioning button.
3. Set the mode to the Face Level  mode.
4. Set the air intake control to Recirculation mode temporarily to allow the cabin to cool quickly. When the desired temperature in the cabin is reached, change the air intake control back to Fresh mode.
5. Adjust the fan speed control and temperature control to maintain maximum comfort.

When maximum cooling is desired, set the temperature control to the lowest position, then set the fan speed control to the highest setting.

### NOTICE

- **When using the air conditioning system, monitor the engine temperature gauge closely while driving up hills or in heavy traffic when outside temperatures are high. Air conditioning system operation when climbing a steep grade or in high outside ambient temperatures can cause engine overheating. Continue to use the fan, but turn the air conditioning system off if the engine temperature gauge indicates engine overheating.**
- **The air conditioning evaporator (cooling coil) shall never be repaired or replaced with one removed from a used or salvaged vehicle and new replacement MAC evaporators shall be certified (and labeled) as meeting SAE Standard J2842.**

#### Air conditioning system operation tips

- If the vehicle has been parked in direct sunlight during hot weather, open the windows for a short time to let the hot air inside the vehicle escape.
- After sufficient cooling has been achieved, switch back from the recirculated air to the fresh outside air position.
- To help reduce moisture inside of the windows on rainy or humid days, decrease the humidity inside the vehicle by operating the air conditioning system with the windows and sunroof closed.
- Use the air conditioning system every month for a few minutes to ensure maximum system performance.
- If you operate the air conditioner excessively, the difference between the temperature of the outside air and that of the windshield could cause the outer surface of the windshield to fog up, causing loss of visibility. In this case, set the mode selection button to the  position and set the fan speed control knob to the lowest speed setting.

#### System Maintenance

##### Cabin air filter

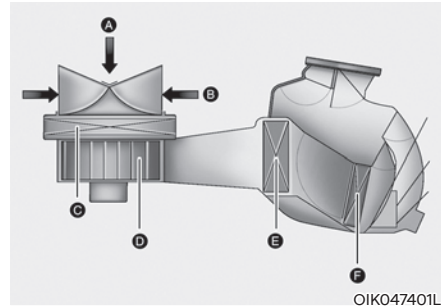

[A] : Outside air, [B] : Recirculated air  
[C] : Cabin air filter, [D] : Blower  
[E] : Evaporator core, [F] : Heater core

The cabin air filter is installed behind the glove box. It filters the dust or other pollutants that enter the vehicle through the heating and air conditioning system.

Have the cabin air filter replaced by an authorized HYUNDAI dealer according to the maintenance schedule. If the vehicle is being driven in severe conditions such as dusty or rough roads, more frequent climate control filter inspections and changes are required.

If the air flow rate suddenly decreases, the system should be checked at an authorized HYUNDAI dealer.

### ***Air Conditioning Performance and Maintenance at Your HYUNDAI Dealer***

When the amount of refrigerant is low, the performance of the air conditioning is reduced. Overfilling also reduces the performance of the air conditioning system.

Therefore, if abnormal operation is found, have the system inspected by an authorized HYUNDAI dealer.

#### **NOTICE**

**It is important that the correct type and amount of oil and refrigerant is used. Otherwise, damage to the compressor and abnormal system operation may occur. To prevent damage, the air conditioning system in your vehicle should only be serviced by trained and certified technicians.**



#### **WARNING**

Vehicles equipped with R-1234yf



Since the refrigerant is mildly flammable and operated at high pressure, the air conditioning system should only be serviced by trained and certified technicians. It is important that the correct type and amount of oil and refrigerant are used.

**All refrigerants should be reclaimed with proper equipment. Venting refrigerants directly to the atmosphere is harmful to individuals and environment. Failure to heed these warnings can lead to serious injuries.**



#### **Air Conditioning refrigerant label**

You can find out which air conditioning refrigerant is applied to your vehicle on the label located inside of the hood.

#### ■ Example

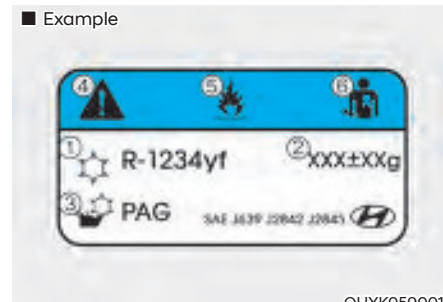



Each symbol and specification on the air conditioning refrigerant label is represented as below:

1. Classification of refrigerant
2. Amount of refrigerant
3. Classification of compressor lubricant
4. Caution
5. Flammable refrigerant
6. To require registered technician to service air conditioning system

## WINDSHIELD DEFROSTING AND DEFOGGING

### WARNING

#### Windshield heating

Do not use the  position during cooling operation in extremely humid weather. The difference between the temperature of the outside air and that of the windshield could cause the outer surface of the windshield to fog up, causing loss of visibility could cause an accident resulting in serious injury or death. In this case, set the mode selection button to the  position and fan speed control knob to a lower speed.



- For maximum defrost performance, set the temperature control to the highest temperature setting and the fan speed control to the highest setting.
- If warm air to the floor is desired while defrosting or defogging, set the mode to the floor-defrost position.
- Before driving, clear all snow and ice from the windshield, rear window, side view mirrors, and all side windows.
- Clear all snow and ice from the hood and air inlet in the cowl grill to improve heater and defroster efficiency and to reduce the probability of fogging up the inside of the windshield.

### **NOTICE**

If the engine temperature is still cold after starting, then a brief engine warm up period may be required for the vented air flow to become warm or hot.

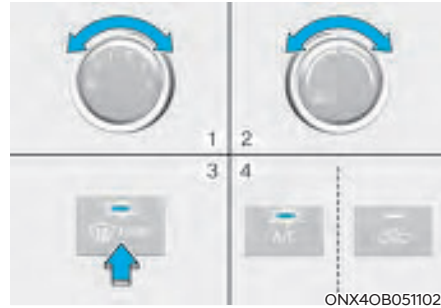
### Manual Climate Control System *To defog inside windshield*



1. Select any fan speed except "0" position.
2. Select the desired temperature.
3. Press the defroster button (.
4. The outside (fresh) air will be selected automatically. Additionally, the air conditioning (if equipped) will automatically operate if the mode is selected to the  position.

If the air conditioning and outside (fresh) air position are not selected automatically, press the corresponding button manually.

**To defrost outside windshield**

1. Set the fan speed to the highest (extreme right) position.
2. Set the temperature to the extreme hot position.
3. Press the defroster button (☀️).
4. The outside (fresh) air and air conditioning (if equipped) will be selected automatically.

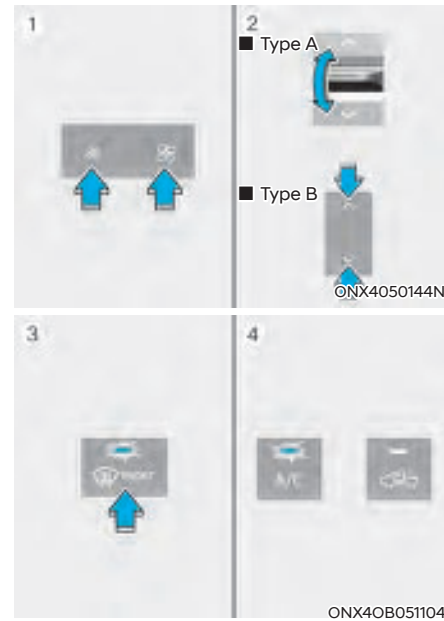
**Automatic Climate Control System****To defog inside windshield**

1. Select the desired fan speed.
2. Select the desired temperature.
3. Press the defroster button (☀️).
4. The air-conditioning will turn on according to the detected ambient temperature, outside (fresh) air position and higher fan speed will be selected automatically.

If the air-conditioning, outside (fresh) air position and higher fan speed are not selected automatically, adjust the corresponding button or knob manually.

If the ☀️ position is selected, lower fan speed is controlled to higher fan speed.

### To defrost outside windshield

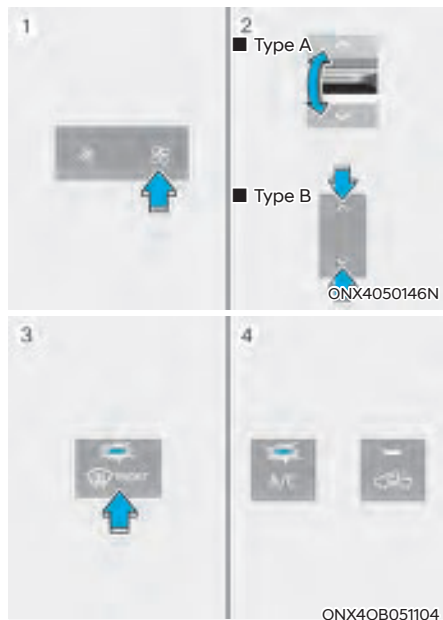

1. Set fan speed to the highest position.
2. Set temperature to the extreme hot (HI) position.
3. Press the defroster button (☀️).
4. The air-conditioning will turn on according to the detected ambient temperature and outside (fresh) air position will be selected automatically.

If the ☀️ position is selected, lower fan speed is controlled to higher fan speed.

### Rear window defroster

#### NOTICE

To prevent damage to the rear window defroster conducting elements bonded to the inside surface of the rear window, never use sharp instruments or window cleaners containing abrasives to clean the window.



The defroster heats the window to remove frost, fog and thin ice from the interior and exterior of the rear window, while the engine is running.

- To activate the rear window defroster, press the rear window defroster button located in the center control panel. The indicator on the rear window defroster button illuminates when the defroster is ON.
- To turn off the defroster, press the rear window defroster button again.

#### i Information

- If there is heavy accumulation of snow on the rear window, brush it off before operating the rear defroster.
- The rear window defroster automatically turns off after approximately 20 minutes or when the ignition switch is in the OFF position.



## CLIMATE CONTROL ADDITIONAL FEATURES

### Auto Defogging System on Models with Automatic Temperature Control (if equipped)



Auto defogging helps reduce the possibility of fogging up the inside of the windshield by automatically sensing the moisture on inside the windshield.

The auto defogging system operates when the heater or air conditioning is on.

#### **i** Information

The auto defogging system may not operate normally, when the outside temperature is below 14°F (10°C).



When the Auto Defogging System operates, the indicator will illuminate.

If a high amount of humidity is detected in the vehicle, the Auto Defogging System will be enabled. The following steps will be performed automatically:

- Step 1) Air conditioning will turn ON.
- Step 2) Air intake control will change to Fresh mode.
- Step 3) Mode will change to defrost to direct airflow to the windshield.
- Step 4) Fan speed will be set to MAX.

If the air conditioning is off or recirculation mode is manually selected while Auto Defogging System is ON, the Auto Defogging System indicator will blink 3 times to signal that the manual operation has been canceled.

### **Turning the Auto Defogging System ON or OFF**

#### **Climate control system**

Press the front windshield defroster button for 3 seconds when the ignition switch or the Engine Start/Stop button is in the ON position. When the Auto Defogging System is turned off, the ADS OFF symbol will blink 3 times and ADS OFF will be displayed on the climate control information screen.

When the Auto Defogging System is turned on, the ADS OFF symbol will blink 6 times without a signal.

#### **Infotainment system**

Auto Defogging System can be turned on and off by selecting 'Setup → Vehicle Settings → Climate → Defog/Defrost Options → Auto Defog' from the infotainment system screen.

**For detailed information, refer to the separately supplied infotainment system manual.**

### **Information**

- When the air conditioning is turned on by Auto Defogging System, if you try to turn off the air conditioning, the indicator will blink 3 times and the air conditioning will not be turned off.
- To maintain the effectiveness and efficiency of the Auto Defogging System, do not select Recirculation mode while the system is operating.
- When Auto Defogging System is operating, fan speed adjustment, temperature adjustment, and air intake control selection are all disabled.

### **NOTICE**

**Do not remove the sensor cover located on the upper end of the windshield glass.**

**Damage to system parts could occur and may not be covered by your vehicle warranty.**

5-110

### **Auto Dehumidify (if equipped)**

To increase cabin air quality and reduce windshield misting, recirculation mode switches off automatically after about 5 to 30 minutes, depending on the outside temperature, and the air intake will change to fresh mode.

### **Turning Auto Dehumidify ON or OFF**

#### **Climate control system**

To turn the Auto Dehumidify feature on or off, select Face level (👤) mode and while holding down the A/C icon, press the air intake control (🌬️) button at least five times within three seconds. When Auto Dehumidify is turned on, the air intake control button indicator will blink 6 times. When turned off, the indicator will blink 3 times.

#### **Infotainment system**

Auto Dehumidify can be turned on and off by selecting 'Setup → Vehicle Settings → Climate → Automatic Ventilation → Auto Dehumidify' from the infotainment system screen.

**For detailed information, refer to the separately supplied infotainment system manual.**

### Recirculating Air when washer fluid is used (if equipped)

Recirculation mode automatically activates to reduce any objectionable scent of the washer fluid from entering the cabin when the windshield washer is used.

When it is shifted to the recirculation mode, the unpleasant scent may flow into the vehicle.

However, in cold weather to prevent the windshield from fogging up, the recirculation mode may not be selected.

### Turning Activate upon Washer Fluid Use ON or OFF

#### Climate control system

To turn the Activate upon Washer Fluid Use feature on or off, select Floor level (🚶) mode, and then press the air intake control (🌬️) button four times within two seconds while pressing the A/C icon.

When Activate upon Washer Fluid Use ON is turned on, the air intake control button indicator will blink 6 times. When turned off, the indicator will blink 3 times.

#### Infotainment system

Activate upon Washer Fluid Use can be turned on and off by selecting 'Setup → Vehicle Settings → Climate → Recirculate Air → Activate upon Washer Fluid Use (or Interlocking washer fluid)' from the infotainment system screen.

**For detailed information, refer to the separately supplied infotainment system manual.**

### Sunroof Inside Air Recirculation (if equipped)

When the sunroof is opened, fresh mode will be automatically selected. At this time, if you press the air intake control button, recirculation mode will be selected but will change back to fresh mode after 3 minutes. When the sunroof is closed, the air intake position will return to the original position that was selected.

### Automatic Controls for the Driver Based on Climate Control System Settings

The temperature of the driver's seat warmer, air ventilated seat and heated steering wheel is automatically controlled depending on the inside and outside temperature of the vehicle when the engine is running.

To use these features, it must be enabled from the Settings menu in the infotainment system screen. Select:

- Setup → Vehicle Settings → Seat → Heated/Ventilated Features → Heated/Ventilated Features → Auto. Controls That Use Climate Control Settings

**For more details on Auto Comfort Control, refer to "Seat Warmers" and "Air ventilation seats" section in chapter 3 and "Heated Steering Wheel" section in chapter 5.**

## STORAGE COMPARTMENT

### WARNING

Never store cigarette lighters, propane cylinders, or other flammable/explosive materials in the vehicle. These items may catch fire and/or explode if the vehicle is exposed to hot temperatures for extended periods.

### WARNING

**ALWAYS** keep the storage compartment covers closed securely while driving. Items inside your vehicle are moving as fast as the vehicle. If you have to stop or turn quickly, or if there is a crash, the items may fly out of the compartment and may cause an injury if they strike the driver or a passenger.

### **NOTICE**

To avoid possible theft, do not leave valuables in the storage compartments.

## Center Console Storage



To open:  
Press the button.

### Glove Box



To open:  
Pull the lever.

#### **WARNING**

**ALWAYS** close the glove box door after use.

An open glove box door can cause serious injury to the passenger in an accident, even if the passenger is wearing a seat belt.

### Storage Box Under the Rear Seat

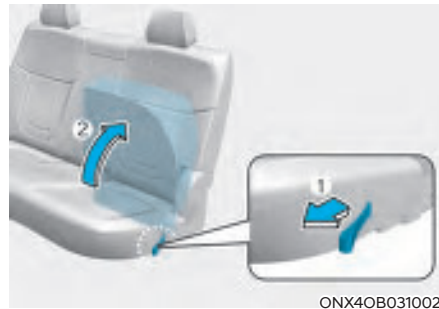

Lift and fold up the rear seat.

#### **WARNING**

Do not sit on the storage box. It may damage the storage box or cause serious injury in the event of sudden braking collision.

## LUGGAGE COMPARTMENT FEATURES

### Tonneau Cover (if equipped)

#### Locking the tonneau cover

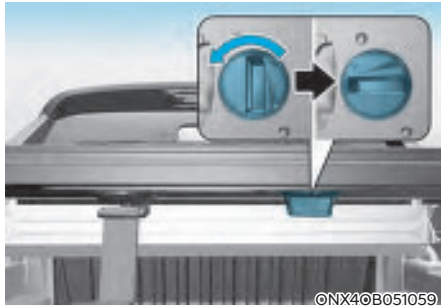

Turn lock knob 90 degrees counter-clockwise to lock the tonneau cover.

#### Unlocking the tonneau cover

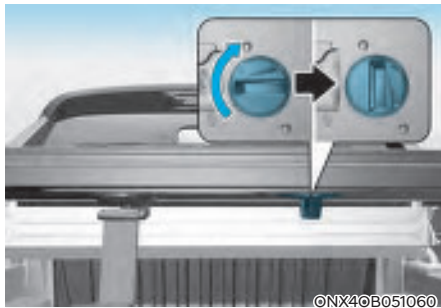

Turn lock knob 90 degrees clockwise to unlock the tonneau cover.

#### Emergency release

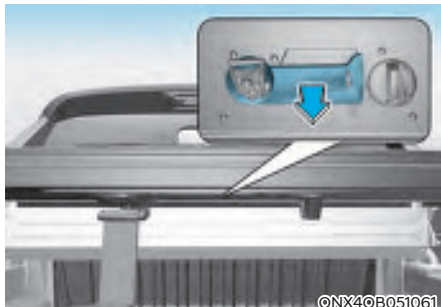

Push emergency release lever.

#### Fully opening tonneau cover

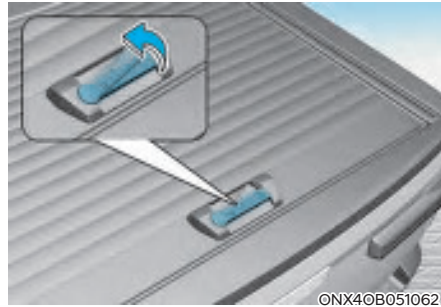

1. Make sure that tonneau cover is unlocked.
2. Push tonneau handle forward until unlatched. Handle will stay in "unlatched" position.



3. Tonneau cover will retract and fully.

#### **i** Information

The purpose of tonneau cover is to cover the bed from rain and dirt:

- Designed to withstand rain water, some water ingress may occur. In the tailgate area there will be water ingress due to lack of sealing.
- Dust can enter the compartment through various gaps around the tailgate area, other sealings etc.

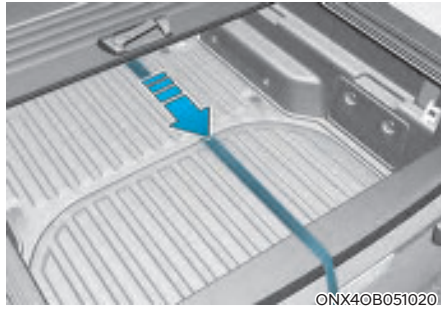
**Fully closing tonneau cover**

1. Use strap to pull tonneau cover until handle can be reached.



2. Return handle to "latched" position.
3. Pull tonneau cover rearward until it latches against the tailgate.

**Half opening tonneau cover (from open)**

1. Pull strap 45 degrees to the left to return handle to "latched" position.

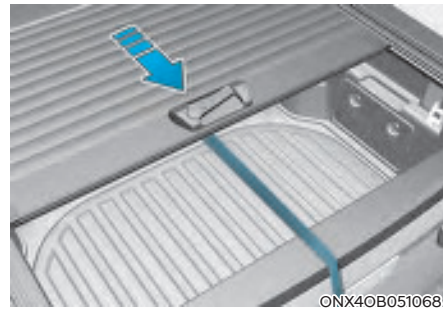

2. Use strap to close tonneau past half open position, then release. latch pins will make audible click.

**Half opening tonneau cover (from closed)**

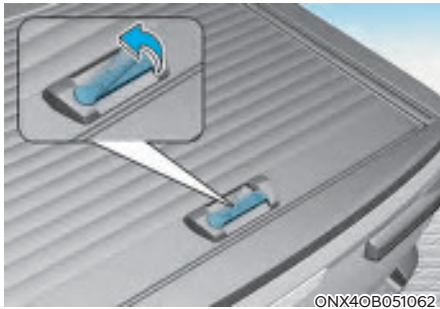

1. Push tonneau handle forward until unlatched. (Handle will stay in “unlatched” position)

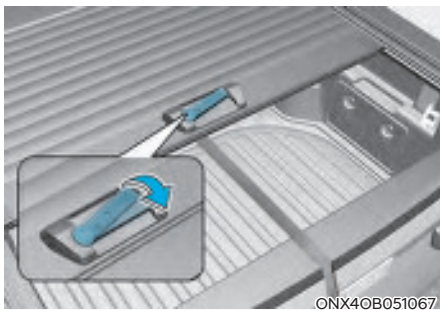

2. Return handle to “latched” position.
3. Tonneau cover will open and stop at halfway position.

**NOTICE**

- Tonneau cover is made of aluminium profiles which heats up and cools down relatively quick according to weather conditions. This can cause condensation on the inside of the profiles and the panels.
- The pull strap has been designed only for opening and closing the Roll cover. The carabineer and ring will be damaged in case of excessive load.
- Goods in the pickup bed must be secured during transportation to prevent damage on the structural parts of tonneau cover (especially the canister.)
- If the tonneau cover is closed and has water, snow, ice or dirt on the cover, it might enter into the pickup bed as the cover retracts. To avoid this, clean off the top surface of the cover prior to opening.
- When opening the cover, the opening should be careful and controlled using the pull strap to prevent the cover from hitting the front with full speed, which it has NOT been designed for.

 **CAUTION**

- The Roll cover is not designed for loading although it can support normal snow loads. No part of it can support any load from cargo or persons and the product might be damaged if somebody stands on it.





### WARNING

- Do not drive with persons under the tonneau cover.
- Do not allow persons or animals to stay in the pickup bed when the cover is closed.
- Temperatures can be very high under the cover when closed.
- The pull strap should not be used to tie down cargo.
- Do not disassemble the main shaft from the canister without relieving the spring tension completely.
- Remove fingers from lamellas when opening and closing.
- We do not recommend washing the tonneau cover in a brushless carwash, as the coating may be damaged due to use of chemicals.
- Wash the Roll cover regularly using normal car shampoo and a soft, lint free cloth or brush.
- If washed in any carwash, or if any chemicals are used on the roll cover, please ensure a max PH value of 8 is used.
- 

### Sidewall Molded in Features

Commonly sold lumber items to be added to the pickup bed, allowing users to customize.

#### 2x6 cross pickup bed support shelf



©NX4OB051073

Cut two 2"x6" pieces of standard lumber to ~52" lengths and inset into forming's provided on the sidewalls.



©NX4OB051074

A 4'x4' sheet of plywood can be placed on top of the 2x6 supports to form a shelf within the pickup bed.

### **Plywood carrying shelf**

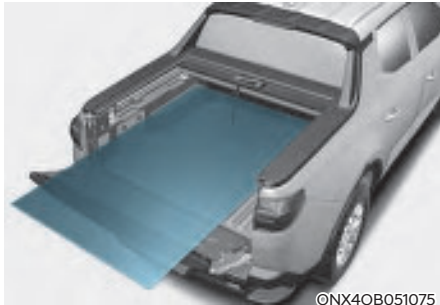

Steps to put tailgate in plywood position:

1. Detach both left and right support cables.
2. Lift tailgate upward to 20 degrees from full open position.
3. Connect both cables just below.

### **⚠️ WARNING**

- Close the tonneau cover securely before driving.
- Cargo should not be interfered with tonneau cover latching and completely closing.
- When the tonneau cover is fully opened, make sure that the buckle is secure by pulling on the storage strap.
- Be careful not to get your hands pinched between the tonneau cover and the deck when opening and closing the tonneau cover, or between the panels when folding.
- Make sure that all latches are securely locked by pulling it upwards.
- Do not stand or sit on the tonneau cover.
- Do not install the tonneau cover backwards, or in any other orientation than indicated.

### **⚠️ WARNING**

- Allowing passengers to ride in the pickup bed or on the tailgate can result in death or serious injury in a crash. Make sure all passengers ride in a seat and wear a seat belt properly.
- Never let passengers ride in the pickup bed, in the trunk space, or on the bed rails. This could cause very serious injuries or death. No one should ride in any position on your vehicle that is not equipped with seats and seat belts.
- Exceeding load limits or improperly loading cargo on the vehicle can cause a crash in which you can be seriously injured or killed.
- Load the cargo securely before starting to drive.

## Underbed Storage

The underbed storage area is water resistant and can be locked and unlocked using the remote key or smart key.

### Opening underbed storage

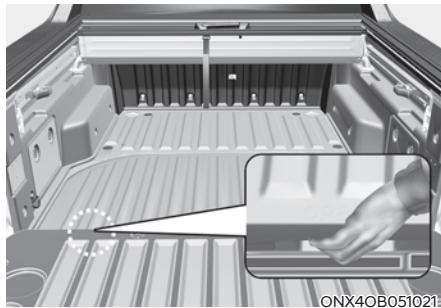

The underbed storage can be unlocked and opened by the following methods:

Vehicles equipped with remote key:

- Unlocking all doors using the main unlock button in the vehicle or by pressing the unlock button on the remote key.

Vehicles equipped with Smart key:

- Unlocking all the doors using the main unlock button in the vehicle or by pressing the unlock button on the smart key.
- Having the smart key in your possession, opening the tailgate, and then simply pressing the underfloor storage release button.

### Closing underbed storage



To close the underbed storage lid, pull the lid downward.

Note that if the underbed storage lid is not fully closed, the LED bed lamps will remain on and a warning message may appear in the LCD cluster display.

### **i** Information

**It is common for the underfloor storage bin to have a scent when the vehicle is new. This scent is normal, safe, and will be reduced over time, similar to any new car smell.**

### **!** CAUTION

- **Underbed storage should be dried before closing the lid to prevent mold growth.**
- **Take care to keep water channel and sealing surface clear of debris.**
- **Do not store the valuable items underbed storage area.**
- **Do not apply water directly to the underbed storage bin latch. It may cause latch damage.**

 **WARNING**



- Do not go into the underbed storage.
- If someone is locked inside the bin, push the emergency release lever (1).

***How to open underbed storage lid manually***

If there is an electrical failure that prevents the bed underbed storage lid from opening, the latch can be mechanically released using the following steps:

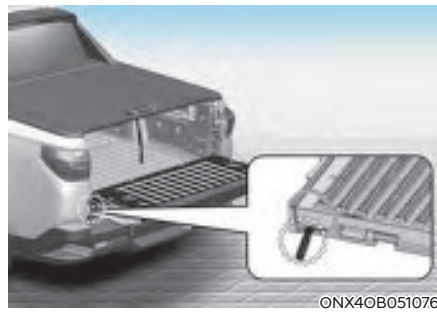

1. Remove the tailgate assembly from its hinges.



2. Insert a ridged hook or tool between the lid and floor, locating the release cable with the tool.
3. Provide an even downward force to release the latch.

### Sidewall Side Storage

#### Opening/Closing sidewall side storage



Turn the two knobs to open/close the lid

#### Power Outlet (if quipped)

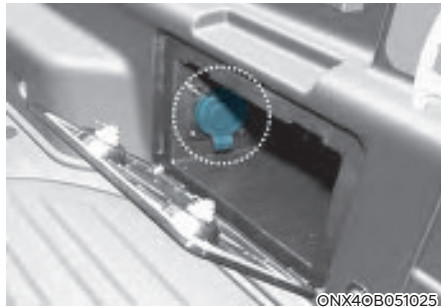

Power outlet is located in the passenger side sidewall side storage bin.

#### To use the power outlet

1. Turn the two knobs to the left to open the lid.
2. Open the cover and plug in the appliance slightly.

#### CAUTION

- Do not use the power outlet for electrical appliances that require high initial peak wattage, such as cathode-ray tube type televisions, refrigerators, electric pumps, etc. It is not suitable for devices that process precise data, such as medical equipment, and that require an extremely stable power supply, such as microcomputer-controlled electric blankets, touch sensor lamps, etc.
- When the power outlet is not in use, close the cover to prevent any small foreign objects from getting into the power outlet.

#### WARNING

- Continued use of any electrical appliance/device exceeding these ratings may result in damage to the appliance/device.
- Make sure that no moisture is trapped in a bin when closed to prevent mold growth.

## Tie Down

### Tie Down Locations

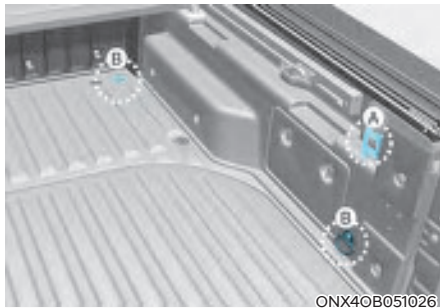

[A] Fixed Tie Down

[B] D-Ring

You can secure cargo to the vehicle using hooks, ropes and straps with heavy duty tie downs from various location on the pickup bed.

- Fixed Tie Down also acts as a Cleat for looping rope.
- D-Ring can be rotated about the bolt and the bracket.
- D-Ring and Fixed Tie Down can be hooked through their openings.

### **i** Information

- **Put cargo evenly on the pickup bed. Place the heaviest items on the bottom and as far forward as possible of the rear axle. Tie down and secure all items that could be thrown out of the vehicle during a crash or sudden stop.**
- **If you stack items higher than the bed sides, tailgate, or back window, secure them with a net or cover. This will reduce the risk of items being thrown out of the pickup bed during a crash or sudden stop.**

### **⚠** CAUTION

- Load the cargo securely before starting to drive.

### **⚠** WARNING

- Do not exceed 440 lbs. (200 kgf) load on a tie down.

### **⚠** WARNING

- Allowing passengers to ride in the pickup bed or on the tailgate can result in death or serious injury in a crash. Make sure all passengers ride in a seat and wear a seat belt properly
- Never let passengers ride in the pickup bed, in the trunk space, or on the bed rails. This could cause very serious injuries or death. No one should ride in any position on your vehicle that is not equipped with seats and seat belts.
- Exceeding load limits or improperly loading cargo on the vehicle can cause a crash in which could result in serious injury or death.
- Load the cargo carefully before starting to drive.

## Rail and cleat system (If equipped)

### *Rail and cleat Locations*

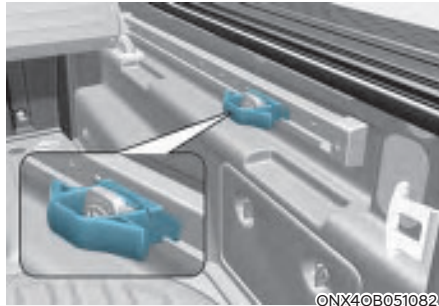

You can secure cargo with adjustable heavy duty cleat tie downs, repositioning the tie downs to suit the exact needs. Cleat can be used with ropes, hooks, and straps. It can be hooked through the center or wrapped around the cleats.

### *To use the cleat*

1. Pull and Twist on Cleat Knob until Knob is fully disengaged and locked.
2. Slide the Cleat to desired position.
3. Unlock the Knob by twisting the knob in the opposite direction.
4. Slide the Cleat until the plunger is locked into a detent.



### **WARNING**

- **Do not exceed 250 lbs. (113 kgf) load on a tie down.**
- **Do not load the cleat above or below 45 degrees from the horizontal.**
- **Do not apply a load to an unlocked cleat.**

## INTERIOR FEATURES

### Cup Holder

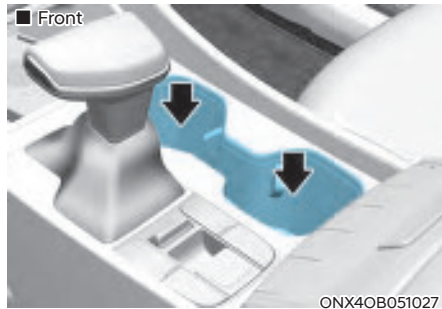

Cups or small beverages cups may be placed in the cup holders.

#### **WARNING**

- Avoid abrupt starting and braking when the cup holder is in use to prevent spilling your drink. If hot liquid spills, you could be burned. Such a burn to the driver could cause loss of vehicle control resulting in an accident.
- Do not place uncovered or unsecured cups, bottles, cans, etc., in the cup holder containing hot liquid while the vehicle is in motion. Injuries may result in the event of a sudden stop or collision.
- Only use soft cups in the cup holders. Hard objects can injure you in an accident.

#### **WARNING**

Keep cans or bottles out of direct sun light and do not put them in a hot vehicle. It may explode.

#### **NOTICE**

- Keep your drinks sealed while driving to prevent spilling your drink. If liquid spills, it may get into the vehicle's electrical/electronic system and damage electrical/electronic parts.
- When cleaning spilled liquids, do not use hot air to blow out or dry the cup holder. This may damage the interior.



## Sunvisor

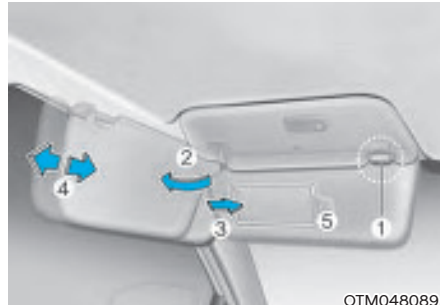

To use the sunvisor, pull it downward.

To use the sunvisor to block the sun from the side window, pull it downward, release it from the bracket (1) and swing it to the side (2) towards the window.

To use the vanity mirror, pull down the sunvisor and slide the mirror cover (3).

Adjust the sunvisor forward or backward (4) as needed (if equipped). Use the ticket holder (5) to hold tickets.

Close the vanity mirror cover securely and return the sunvisor to its original position after use.



### WARNING

For your safety, do not block your view when using the sunvisor.

### NOTICE

The tab (5) adjacent to the vanity mirror on the sunvisor can be used for toll road tickets or self parking tickets. Use caution when inserting tickets into the ticket holder to avoid damage. Refrain from putting several tickets in the ticket holder as this could also damage the retaining tab.

## Power Outlet



The power outlet is designed to provide power for mobile telephones or other devices designed to operate with vehicle electrical systems. The devices should draw less than 180 watts with the engine running.



### WARNING

Avoid electrical shocks. Do not place your fingers or foreign objects (pin, etc.) into a power outlet or touch the power outlet with a wet hand.

 **CAUTION**

To prevent damage to the power outlets:

- Use the power outlet only when the engine is running and remove the accessory plug after use. Using the accessory plug for prolonged periods of time with the engine off could cause the battery to discharge.
- Only use 12 volts electric accessories which are less than 180 watts in electric capacity.
- Adjust the air-conditioner or heater to the lowest operating level when using the power outlet.
- Close the cover when not in use.
- Some electronic devices can cause electronic interference when plugged into a vehicle's power outlet. These devices may cause excessive audio static and malfunctions in other electronic systems or devices used in your vehicle.
- Push the plug in as far as it will go. If good contact is not made, the plug may overheat and the fuse may open.
- Plug in battery equipped electrical/electronic devices with reverse current protection. The current from the battery may flow into the vehicle's electrical/electronic system and cause system malfunction.

### USB Charger

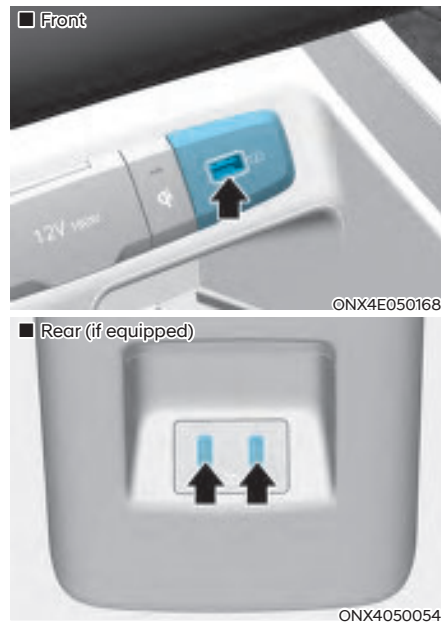

The USB charger is designed to recharge batteries of small size electrical devices using a USB cable.

The electrical devices can be recharged when the ignition switch is in the ACC or ON (or START) position.

The battery charging state may be monitored on the electrical device.

Disconnect the USB cable from the USB port after use.

- A smart phone or a tablet PC may get warmer during the re-charging process. It does not indicate any malfunction with the charging system.
- A smart phone or a tablet PC, which adopts a different re-charging method, may not be properly re-charged. In this case, use an exclusive charger of your device.
- The charging terminal is only to recharge a device. Do not use the charging terminal either to turn ON an audio or to play media in the infotainment system.

### Wireless Smart Phone Charging System (if equipped)

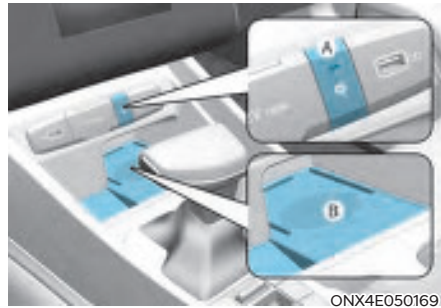

[A] : Indicator light, [B] : Charging pad

On certain models, the vehicle comes equipped with a wireless smart phone charger.

The system is available when all doors are closed, and when the ignition switch or the Engine Start/Stop button is in the ON (or START) position.

#### **To charge a cellular phone**

The wireless smart phone charging system charges only the Qi-enabled smart phones (☑). Read the label on the smart phone accessory cover or visit your smart phone manufacturer's website to check whether your smart phone supports the Qi technology.

The wireless charging process starts when you put a Qi-enabled smart phone on the wireless charging unit.

1. Remove other items, including the smart key, from the wireless charging unit. If not, the wireless charging process may be interrupted. Place the smart phone on the center of the charging pad.
2. The indicator light is orange when the smart phone is charging. The indicator light will turn blue when phone charging is complete.
3. You can turn ON or OFF the wireless charging function from the Settings menu on the instrument cluster. Select:
  - Setup → User settings → Convenience → Wireless Charging

If your smart phone is not charging:

- Slightly change the position of the smart phone on the charging pad.
- Make sure the indicator light is orange.

The indicator light will blink orange for 10 seconds if there is a malfunction in the wireless charging system.

In this case, temporarily stop the charging process, and re-attempt to charge your smart phone again.

The system warns you with a message on the LCD display if the smart phone is still on the wireless charging unit after the vehicle is turned OFF and the front door is opened.

For some manufacturer's smart phones, the system may not warn you even though the smart phone is left on the wireless charging unit. This is due to the particular characteristic of the smart phone and not a malfunction of the wireless charging.

### Information

**For some manufacturers' cellular phones, the system may not warn you even though the cellular phone is left on the wireless charging unit. This is due to the particular characteristic of the cellular phone and not a malfunction of the wireless charging.**

### **NOTICE**

- **The wireless smart phone charging system may not support certain smart phones, which are not verified for the Qi specification (Qi).**
- **When placing your smart phone on the charging pad, position the phone in the middle of the mat for optimal charging performance. If your smart phone is off to the side, the charging rate may be less and in some cases the smart phone may experience higher heat conduction.**
- **In some cases, the wireless charging may stop temporarily when the smart key is used, either when starting the vehicle or locking/unlocking the doors, etc.**
- **When charging certain smart phones, the charging indicator may not change to blue when the smart phone is fully charged.**
- **The wireless charging process may temporarily stop, when temperature abnormally increases inside the wireless smart phone charging system. The wireless charging process restarts when temperature falls to a certain level.**
- **The wireless charging process may temporarily stop when there is any metallic item, such as a coin, between the wireless smart phone charging system and smart phone.**

- When charging some smart phones with a self-protection feature, the wireless charging speed may decrease and the wireless charging may stop.
- If the smart phone has a thick cover, the wireless charging may not be possible.
- If the smart phone is not completely contacting the charging pad, wireless charging may not operate properly.
- Some magnetic items like credit cards, phone cards or rail tickets may be damaged if left with the smart phone during the charging process.
- When any smart phone without a wireless charging function or a metallic object is placed on the charging pad, a small noise may sound. This small sound is due to the vehicle discerning compatibility of the object placed on the charging pad. It does not affect your vehicle or the smart phone in any way.

### Information

If the Ignition switch is in the OFF position, the charging also stops.

### Information

This device complies with Part 15 of the FCC rules. Operation is subject to the following three conditions:

1. This device may not cause harmful interference, and
2. This device must accept any interference received, including interference that may cause undesired operation.
3. Changes or modifications not expressly approved by the party responsible for compliance could void the user's authority to operate the device.

### Clock

The clock can be set from the infotainment system.

For detailed information, refer to the separately supplied infotainment system manual.

### WARNING

Do not attempt to adjust the clock while driving. Doing so may result in distracted driving which may lead to an accident involving personal injury or death.

### Coat Hook



These hooks are not designed to hold large or heavy items.

#### **WARNING**



Do not hang other objects such as hangers or hard objects except clothes. Also, do not put heavy, sharp or breakable objects in the clothes pockets. In an accident or when the curtain air bag is inflated, it may cause vehicle damage or personal injury.

### Floor Mat Anchor(s)

ALWAYS use the Floor Mat Anchors to attach the front floor mats to the vehicle. The anchors on the front floor carpet keep the floor mats from sliding forward.

#### **WARNING**

Do not overlay additional mats or liners over the floor mats. If using All Weather mats, remove the carpeted floor mats before installing them. Only use floor mats designed to connect to the anchors.

#### **WARNING**

The following must be observed when installing ANY floor mat to the vehicle.

- Ensure to remove a protective film attached on the carpet before attaching a floor mat on the front floor carpet. Otherwise, the floor mat may move freely on the protective film and it could result in unintentional braking or accelerating.
- Ensure that the floor mats are securely attached to the vehicle's floor mat anchor(s) before driving the vehicle.
- Do not use ANY floor mat that cannot be firmly attached to the vehicle's floor mat anchors.
- Do not stack floor mats on top of one another (for example, all-weather rubber mat on top of a carpeted floor mat). Only a single floor mat should be installed in each position.

**IMPORTANT** - Your vehicle was manufactured with driver's side floor mat anchors that are designed to securely hold the floor mat in place. To avoid any interference with pedal operation, HYUNDAI recommends that the HYUNDAI floor mat designed for use in your vehicle be installed.

## EXTERIOR FEATURES

### Roof Rack (if equipped)



Your vehicle may come equipped with roof rack rails. If your vehicle is equipped with roof rack rails, you may be able to add roof rack crossbars as an accessory (not shown).

#### NOTICE

If the vehicle is equipped with a sunroof, be sure not to position cargo onto the roof side rails in such a way that it could interfere with sunroof operation.

#### NOTICE

- When carrying cargo on the roof side rails, take the necessary precautions to make sure the cargo does not damage the roof of the vehicle.
- When carrying large objects on the roof side rails, make sure they do not exceed the overall roof length or width.

#### WARNING

- The following specification is the maximum weight that can be loaded onto the roof side rails. Distribute the load as evenly as possible onto the roof side rails and secure the load firmly.

Loading cargo or luggage in excess of the specified weight limit on the roof side rails may damage your vehicle.

ROOF SIDE RAILS	220 lbs. (100 kg) EVENLY DISTRIBUTED
-----------------	---

- The vehicle center of gravity will be higher when items are loaded onto the roof side rails. Avoid sudden starts, braking, sharp turns, abrupt maneuvers or high speeds that may result in loss of vehicle control or rollover resulting in an accident.
- Always drive slowly and turn corners carefully when carrying items on the roof side rails. Severe wind updrafts, caused by passing vehicles or natural causes, can cause sudden upward pressure on items loaded on the roof side rails. This is especially true when carrying large, flat items such as wood panels or mattresses. This could cause the items to fall off the roof side rails and cause damage to your vehicle or others around you.
- To prevent damage or loss of cargo while driving, check frequently before or while driving to make sure the items on the roof side rails are securely fastened.

## INFOTAINMENT SYSTEM

### NOTICE

- If you install an aftermarket HID head lamp, your vehicle's audio and electronic devices may not function properly.
- Prevent chemicals such as perfume, cosmetic oil, sun cream, hand cleaner, and air freshener from contacting the interior parts because they may cause damage or discoloration.

### USB Port



You can use a USB cable to connect audio devices to the vehicle USB port.

### **i** Information

When using a portable audio device connected to the power outlet, noise may occur during playback. If this happens, use the portable audio device's power source.

### Antenna

#### *Shark fin antenna*

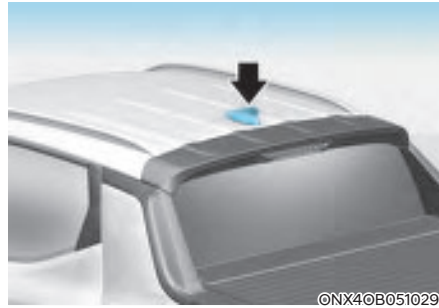

The roof antenna transmits and receives wireless signals such as AM/FM, SXM, GNSS, LTE, etc.

### **i** Information

The signals which the antenna can transmit and receive vary by vehicle option.



## Steering Wheel Remote Controls

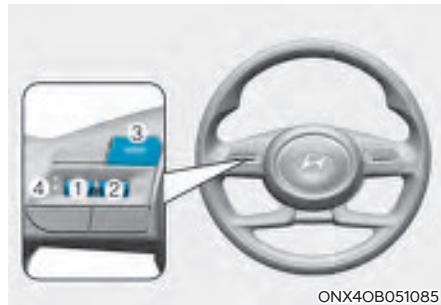

### NOTICE

Do not operate multiple audio remote control buttons simultaneously.

### VOLUME (VOL + / VOL -) (1)

- Rotate the VOLUME scroll up to increase volume.
- Rotate the VOLUME scroll down to decrease volume.

### SEEK/PRESET (^ / v) (2)

If the SEEK/PRESET switch is pressed up or down and held for 0.8 second or more, it will function in the following modes:

- **RADIO mode**  
It will function as the AUTO SEEK select button. It will SEEK until you release the button.
- **MEDIA mode**  
It will function as the FF/RW button.

If the SEEK/PRESET switch is pressed up or down, it will function in the following modes:

- **RADIO mode**  
It will function as the PRESET STATION UP/DOWN button.
- **MEDIA mode**  
It will function as the TRACK UP/DOWN button.

### MODE (3)

Press the MODE button to toggle through Radio or Media modes.

### MUTE (M) (4)

- Press the MUTE button to mute the sound.
- Press the MUTE button again to activate the sound.

### **i** Information

See additional information in supplied Infotainment Manual.

### Infotainment System (if equipped)

For detailed information, refer to the separately supplied infotainment system manual.

### Voice Recognition

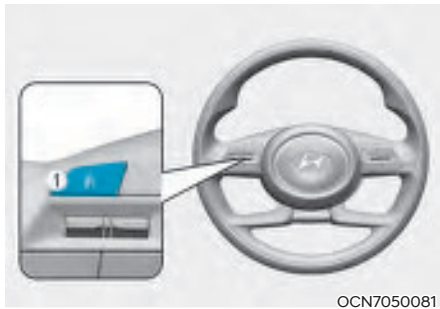

For detailed information, refer to the separately supplied infotainment system manual.

### Bluetooth® Wireless Technology

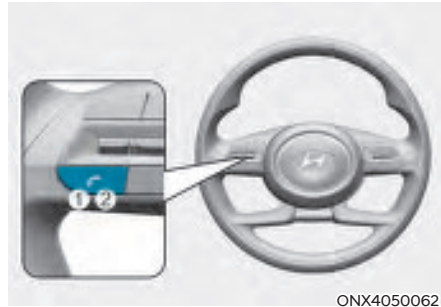

- (1) Call / Answer button
- (2) Call end button
- (3) Microphone

For detailed information, refer to the separately supplied infotainment system manual.



### CAUTION

To avoid driver distractions, do not excessively operate the device while driving the vehicle which may lead to an accident.

## How Vehicle Radio Works

### FM reception

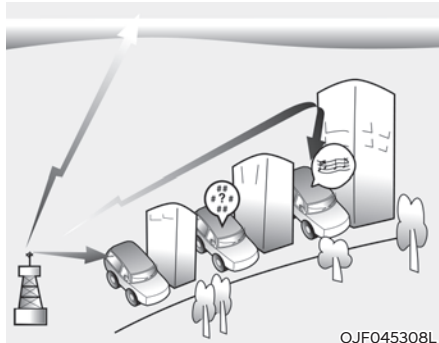

AM and FM radio signals are broadcast from transmitter towers located around your city. They are intercepted by the radio antenna on your vehicle. This signal is then received by the radio and sent to your vehicle speakers.

When a strong radio signal has reached your vehicle, the precise engineering of your audio system ensures the best possible quality reproduction. However, in some cases the signal coming to your vehicle may not be strong and clear.

This can be due to factors, such as the distance from the radio station, closeness of other strong radio stations or the presence of buildings, bridges or other large obstructions in the area.

### AM (MW, LW) reception

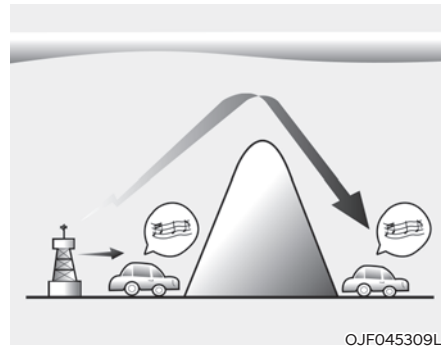

AM broadcasts can be received at greater distances than FM broadcasts. This is because AM radio waves are transmitted at low frequencies. These long, low frequency radio waves can follow the curvature of the earth rather than travelling straight out into the atmosphere.

In addition, they curve around obstructions so that they can provide better signal coverage.

**FM radio station**

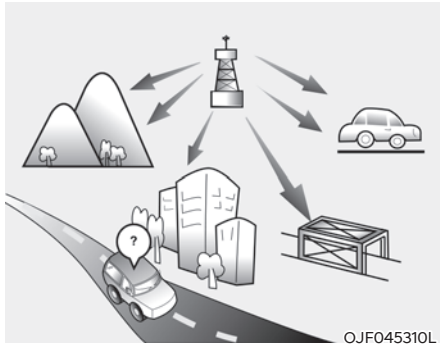

FM broadcasts are transmitted at high frequencies and do not bend to follow the earth's surface. Because of this, FM broadcasts generally begin to fade at short distances from the station. Also, FM signals are easily affected by buildings, mountains, or other obstructions. These can result in certain listening conditions which might lead you to believe a problem exists with your radio.

The following conditions are normal and do not indicate radio trouble :

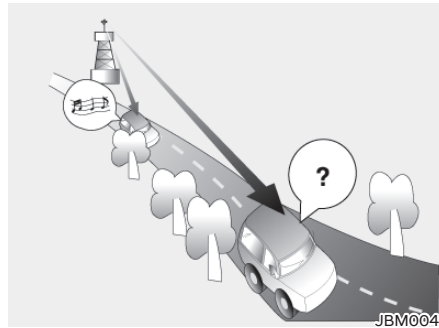

- Fading - As your vehicle moves away from the radio station, the signal will weaken and sound will begin to fade. When this occurs, we suggest that you select another stronger station.
- Flutter/Static - Weak FM signals or large obstructions between the transmitter and your radio can disturb the signal causing static or fluttering noises to occur. Reducing the treble level may lessen this effect until the disturbance clears.

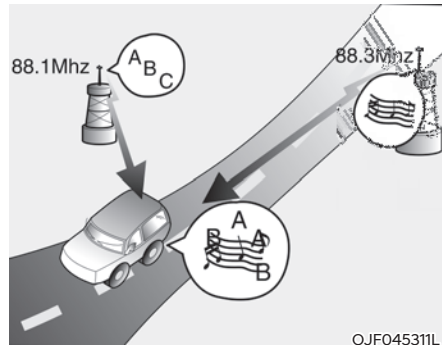

OJF04531L

- Station Swapping - As a FM signal weakens, another more powerful signal near the same frequency may begin to play. This is because your radio is designed to lock onto the clearest signal. If this occurs, select another station with a stronger signal.
- Multi-Path Cancellation - Radio signals being received from several directions can cause distortion or fluttering. This can be caused by a direct and reflected signal from the same station, or by signals from two stations with close frequencies. If this occurs, select another station until the condition has passed.

### ***Using a cellular phone or a twoway radio***

When a cellular phone is used inside the vehicle, noise may be produced from the audio system. This does not mean that something is wrong with the audio equipment. In such a case, use the cellular phone at a place as far as possible from the audio equipment.

#### **NOTICE**

**When using a communication system such as a cellular phone or a radio set inside the vehicle, a separate external antenna must be fitted. When a cellular phone or a radio set is used with an internal antenna alone, it may interfere with the vehicle's electrical system and adversely affect safe operation of the vehicle.**



#### **WARNING**

**Do not use a cellular phone while driving. Stop at a safe location to use a cellular phone.**



## 6. Driving Your Vehicle

Before Driving .....	6-4
Before Entering the Vehicle.....	6-4
Before Starting .....	6-4
Ignition Switch .....	6-5
Key Ignition Switch.....	6-5
Engine Start/Stop Button .....	6-8
Remote Start.....	6-12
Vehicle Auto-Shut Off .....	6-12
Automatic Transmission .....	6-14
Automatic Transmission Operation.....	6-14
Using the Paddle Shifters .....	6-19
Good Driving Practices .....	6-20
Dual Clutch Transmission.....	6-21
Dual Clutch Transmission Operation .....	6-21
Parking .....	6-27
Good Driving Practices .....	6-28
Braking System .....	6-29
Power-assist Brakes .....	6-29
Disc Brakes Wear Indicator.....	6-29
Electronic Parking Brake (EPB) .....	6-30
Auto Hold .....	6-34
Anti-lock Brake System (ABS).....	6-38
Electronic Stability Control (ESC) .....	6-39
Vehicle Stability Management (VSM) .....	6-42
Trailer Stability Assist (TSA) .....	6-43
Hill-Start Assist Control (HAC) .....	6-44
Downhill Brake Control (DBC) .....	6-44
Good Braking Practices .....	6-47
Drive Mode Integrated Control System .....	6-48
All Wheel Drive (AWD) .....	6-51
AWD Operation.....	6-52
Emergency Precautions.....	6-55

---

---

Special Driving Conditions.....	6-57
Hazardous Driving Conditions .....	6-57
Rocking the Vehicle .....	6-57
Smooth Cornering.....	6-58
Driving at Night .....	6-58
Driving in the Rain.....	6-58
Driving in Flooded Areas.....	6-59
Highway Driving.....	6-59
Reducing the Risk of a Rollover .....	6-59
Winter Driving .....	6-60
Snow or Icy Conditions .....	6-60
Winter Precautions.....	6-62
Trailer Towing .....	6-64
Trailer Towing - Important Information .....	6-65
Trailer Towing Equipment .....	6-68
Driving with a Trailer .....	6-69
Maintenance when Towing a Trailer .....	6-72
Vehicle Load Limit .....	6-73
The Loading Information Label .....	6-74



**WARNING**

**Carbon monoxide (CO) gas is toxic. Breathing CO can cause unconsciousness and death.**

Engine exhaust contains carbon monoxide which cannot be seen or smelled.

**Do not inhale engine exhaust.**

If at any time you smell engine exhaust inside the vehicle, open the windows immediately. Exposure to CO can cause unconsciousness and death by asphyxiation.

**Be sure the exhaust system does not leak.**

The exhaust system should be checked whenever the vehicle is raised to change the oil or for any other purpose. If you hear a change in the sound of the exhaust or if you drive over something that strikes the underneath side of the vehicle, have the exhaust system checked as soon as possible by an authorized HYUNDAI dealer.

**Do not run the engine in an enclosed area.**

Letting the engine idle in your garage, even with the garage door open, is a hazardous practice. Run the engine only long enough to start the engine and to move the vehicle out of the garage.

**Avoid idling the engine for prolonged periods with people inside the vehicle.**

If it is necessary to idle the engine for a prolonged period with people inside the vehicle, be sure to do so only in an open area with the air intake set at "Fresh" and fan control set to high so fresh air is drawn into the interior.

**Keep the air intakes clear.**

To assure proper operation of the ventilation system, keep the ventilation air intakes located in front of the windshield clear of snow, ice, leaves, or other obstructions.

**WARNING****CALIFORNIA PROPOSITION 65 WARNING**

**Engine exhaust and a wide variety of automobile components including components found in the interior furnishings in a vehicle, contain or emit harmful chemicals known to the State of California to cause cancer and birth defects and reproductive harm. In addition, certain fluids contained in vehicles and certain products of components contain or emit chemicals known to the State of California to cause cancer and birth defects or other reproductive harm.**

## BEFORE DRIVING

### Before Entering the Vehicle

- Be sure all windows, outside mirror(s), and outside lights are clean and unobstructed.
- Remove frost, snow, or ice.
- Visually check the tires for uneven wear and damage.
- Check under the vehicle for any sign of leaks.
- Be sure there are no obstacles behind you if you intend to back up.

### Before Starting

- Make sure the hood and all doors are securely closed and locked. Unless absolutely necessary for hauling cargo, etc. close the tailgate before driving your vehicle.
- If you are driving with the tailgate down use extra caution when backing up.
- Adjust the position of the seat and steering wheel.
- Adjust the inside and side view mirrors.
- Verify all the lights work.
- Fasten your seat belt. Check that all passengers have fastened their seat belts.
- Check the gauges and indicators in the instrument panel and the messages on the instrument display when the ignition switch is in the ON position.
- Check that any items you are carrying are stored properly or fastened down securely.

### WARNING

To reduce the risk of **SERIOUS INJURY** or **DEATH**, take the following precautions:

- **ALWAYS** wear your seat belt. All passengers must be properly belted whenever the vehicle is moving. For more information, refer to “Seat Belts” section in chapter 3.
- Always drive defensively. Assume other drivers or pedestrians may be careless and make mistakes.
- Stay focused on the task of driving. Driver distraction can cause accidents.
- Leave plenty of space between you and the vehicle in front of you.

### WARNING

**NEVER** drink or take drugs and drive.

Drinking or taking drugs and driving is dangerous and may result in an accident and **SERIOUS INJURY** or **DEATH**.

Drunk driving is the number one contributor to the highway death toll each year. Even a small amount of alcohol will affect your reflexes, perceptions and judgment. Just one drink can reduce your ability to respond to changing conditions and emergencies and your reaction time gets worse with each additional drink.

Driving while under the influence of drugs is as dangerous or more dangerous than driving under the influence of alcohol.

You are much more likely to have a serious accident if you drink or take drugs and drive. If you are drinking or taking drugs, don't drive. Do not ride with a driver who has been drinking or taking drugs. Choose a designated driver or call a taxi.

## IGNITION SWITCH

### WARNING

To reduce the risk of **SERIOUS INJURY** or **DEATH**, take the following precautions:

- **NEVER** allow children or any person who is unfamiliar with the vehicle to touch the ignition switch or related parts. Unexpected and sudden vehicle movement can occur.
- **NEVER** reach through the steering wheel for the ignition switch, or any other control, while the vehicle is in motion. The presence of your hand or arm in this area may cause a loss of vehicle control resulting in an accident.

### Key Ignition Switch (if equipped)

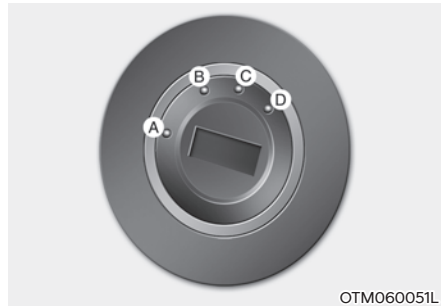

[A] : LOCK, [B] : ACC  
[C] : ON, [D] : START

Whenever the front door is opened, the ignition switch will illuminate, provided the ignition switch is not in the ON position. The light will go off immediately when the ignition switch is turned on or go off after about 30 seconds when the door is closed. (if equipped)

### WARNING

- **NEVER** turn the ignition switch to the LOCK or ACC position while the vehicle is in motion except in an emergency.

This will result in the engine turning off and loss of power assist for the steering and brake systems. This may lead to loss of directional control and braking function, which could cause an accident.

- Before leaving the driver's seat, always make sure the shift lever is in P (Park, for automatic transmission vehicle) position, apply the parking brake, and turn the ignition switch to the LOCK position.

Unexpected vehicle movement may occur if these precautions are not followed.

### **NOTICE**

Never use aftermarket keyhole covers. This may generate start-up failure due to communication failure.

**Key ignition switch positions**

Switch Position	Action	Notes
<b>LOCK</b>	To turn the ignition switch to the LOCK position, push the key in at the ACC position and turn the key towards the LOCK position. The ignition key can be removed in the LOCK position. The steering wheel locks to protect the vehicle from theft. (if equipped)	
<b>ACC</b>	Some electrical accessories are usable. The steering wheel unlocks.	If difficulty is experienced turning the ignition switch to the ACC position, turn the key while turning the steering wheel right and left to release.
<b>ON</b>	This is the normal key position when the engine has started. All features and accessories are usable. The warning lights can be checked when you turn the ignition switch from ACC to ON.	Do not leave the ignition switch in the ON position when the engine is not running to prevent the battery from discharging.
<b>START</b>	To start the engine, turn the ignition switch to the START position. The switch returns to the ON position when you let go of the key.	The engine will crank until you release the key.

### Starting the engine



#### WARNING

- Always wear appropriate shoes when operating your vehicle. Unsuitable shoes, such as high heels, ski boots, sandals, flip-flops, etc., may interfere with your ability to the accelerator and/or brake pedal.
  - Do not start the vehicle with the accelerator pedal depressed.
  - Keep your foot on the brake when shifting out of P (Park). Make sure the engine rpm is at idle before shifting. The vehicle may move suddenly when the brake pedal is released if the engine RPM is high.
1. Make sure the Electronic Parking Brake (EPB) is applied.
  2. Make sure the shift lever is in P (Park).
  3. Depress the brake pedal.
  4. Turn the ignition switch to the START position. Hold the key (maximum of 10 seconds) until the engine starts and release it.

#### Information

- Do not wait for the engine to warm up while the vehicle remains stationary. Start driving at moderate engine speeds. (Avoid hard acceleration when the engine is still cold.)
- Always start the vehicle with your foot on the brake pedal. Do not depress the accelerator while starting the vehicle. Do not race the engine while warming it up.

#### NOTICE

To prevent damage to the vehicle:

- Do not hold the ignition key in the START position for more than 10 seconds. Wait 5 to 10 seconds before trying again.
- Do not turn the ignition switch to the START position with the engine running. It may damage the starter.
- If traffic and road conditions permit, you may put the shift lever in the N (Neutral) position while the vehicle is still moving and turn the ignition switch to the START position in an attempt to restart the engine.
- Do not push or tow your vehicle to start the engine.

### Engine Start/Stop Button (if equipped)



Whenever the front door is opened, the Engine Start/Stop button will illuminate and will go off 30 seconds after the door is closed.

#### **WARNING**

To turn the vehicle off in an emergency: Press and hold the Engine Start/Stop button for more than two seconds **OR** Rapidly press and release the Engine Start/Stop button three times (within three seconds).

If the vehicle is still moving, you can restart the vehicle without depressing the brake pedal by pressing the Engine Start/Stop button with the gear in the N (Neutral) position.

#### **WARNING**

- **NEVER** press the Engine Start/Stop button while the vehicle is in motion except in an emergency. This will result in the vehicle turning off and loss of power assist for the steering and brake systems. This may lead to loss of directional control and braking function, which could cause an accident.
- Before leaving the driver's seat, always make sure the gear is in the P (Park) position, set the parking brake, press the Engine Start/Stop button to the OFF position, and take the Smart Key with you. Unexpected vehicle movement may occur if these precautions are not followed.
- **NEVER** reach through the steering wheel for the Engine Start/Stop button or any other control while the vehicle is in motion. The presence of your hand or arm in this area may cause a loss of vehicle control resulting in an accident.

**Engine stop/start button positions**

Button Position	Action	Notes
<b>OFF</b>	To turn off the engine, press the Engine Start/Stop button with the vehicle shifted to P (Park). Note if the Engine Start/Stop button is pressed with the vehicle shifted to D (Drive) or R (Reverse), the gear will automatically shift to P (Park). If the Engine Start/Stop button is pressed with the gear shifted to N (Neutral), the Engine Start/Stop button will change to the ACC position. The steering wheel locks to protect the vehicle from theft.	If the steering wheel is not locked properly when you open the driver's door, the warning chime will sound.
<b>ACC</b>	Press the Engine Start/Stop button when the button is in the OFF position without depressing the brake pedal. Some of the electrical accessories are usable. The steering wheel unlocks.	<ul style="list-style-type: none"> <li>• If you leave the Engine Start/Stop button in the ACC position for more than one hour, the battery power will turn off automatically to prevent the battery from discharging.</li> <li>• If the steering wheel doesn't unlock properly, the Engine Start/Stop button will not work. Press the Engine Start/Stop button while turning the steering wheel right and left to release.</li> </ul>
<b>ON</b>	Press the Engine Start/Stop button while it is in the ACC position without depressing the brake pedal. The warning lights can be checked before the engine is started.	Do not leave the Engine Start/Stop button in the ON position when the engine is not running to prevent the battery from discharging.
<b>START</b>	To start the engine, depress the brake pedal and press the Engine Start/ Stop button with the gear shifted to the P (Park) or the N (Neutral) position. For your safety, start the engine with the gear shifted to the P (Park) position.	If you press the Engine Start/Stop button without depressing the brake pedal, the engine does not start and the Engine Start/Stop button changes as follows: <b>OFF → ACC → ON → OFF or ACC</b>

### Starting the engine



#### WARNING

- **Always wear appropriate shoes when operating your vehicle. Unsuitable shoes, such as high heels, ski boots, sandals, flipflops, etc., may interfere with your ability to use the brake and accelerator pedals.**
- **Do not start the vehicle with the accelerator pedal depressed.**
- **Keep your foot on the brake when shifting out of P (Park). Make sure the engine rpm is at idle before shifting. The vehicle may move suddenly when the brake pedal is released if the engine RPM is high.**



#### Information

- **The vehicle will start by pressing the Engine Start/Stop button, only when the smart key is in the vehicle.**
- **Even if the smart key is in the vehicle, and when it is far away from the driver, the engine may not start.**
- **When the Engine Start/Stop button is in the ACC or ON position, if any door is open, the system checks for the smart key. When the smart key is not in the vehicle, the “” indicator will blink and the warning 'Key not in vehicle' will come on. When all doors are closed, the chime will also sound for about 5 seconds. Keep the smart key in the vehicle.**

1. Always carry the smart key with you.
2. Make sure the parking brake is applied.
3. Make sure the shift lever is in P(Park).
4. Depress the brake pedal.
5. Press the Engine Start/Stop button.



#### Information

- **Do not wait for the engine to warm up while the vehicle remains stationary. Start driving at moderate engine speeds. (Avoid hard acceleration when the engine is still cold.)**
- **Always start the vehicle with your foot on the brake pedal. Do not depress the accelerator while starting the vehicle. Do not race the engine while warming it up.**



**NOTICE**

To prevent damage to the vehicle:

- If the engine stalls while you are in motion, do not attempt to shift the gear to the P (Park) position.

If traffic and road conditions permit, you may put the gear in N (Neutral) while the vehicle is still moving and press the Engine Start/Stop button in an attempt to restart the engine.

- Do not push or tow your vehicle to start the vehicle.

**NOTICE**

To prevent damage to the vehicle:

Do not press the Engine Start/Stop button for more than 10 seconds except when the stop lamp fuse is blown.

When the stop lamp fuse is blown, you cannot normally start the engine. Replace the fuse with a new one. If you are not able to replace the fuse, you can start the engine by pressing and holding the Engine Start/Stop button for 10 seconds with the Engine Start/Stop button in the ACC position.

For your safety always depress the brake pedal before starting the vehicle.

**i Information**

If the smart key battery is weak or the smart key does not work correctly, you can start the vehicle by pressing the Engine Start/Stop button with the smart key in the direction of the picture above.

**Turning off the engine**

1. Stop the vehicle and depress the brake pedal fully.
2. Make sure the shift lever/button is in P(Park).
3. Press the Engine Start/Stop button to the OFF position and apply the parking brake.

### Remote Start (if equipped)



You can start the vehicle using the Remote Start button of the smart key.

To start the vehicle remotely:

1. Press the door lock button within 32 feet (10 m) from the vehicle.
  2. Press and hold the remote start button (⓪<sub>HOLD</sub>) within 4 seconds after pressing the Door Lock button on the remote.
  3. To turn off the remote start function, press the remote start (⓪<sub>HOLD</sub>) button once.
- The remote start (⓪<sub>HOLD</sub>) button may not operate if the smart key is not within 32 feet (10 m).
  - The vehicle will not remotely start if the engine hood or tailgate is opened.
  - The vehicle must be in P (Park) for the remote start function to start.
  - The engine turns off if you get in the vehicle without a registered smart key.
  - The engine turns off if you do not get in the vehicle within 10 minutes after remotely starting the vehicle.
  - Do not idle the engine for a long period.

### Vehicle Auto-Shut Off

If your vehicle is parked and the engine is left on for a long period of time, the engine will turn off automatically to help reduce fuel consumption and prevent accidents caused by carbon dioxide poisoning.

#### **Operating conditions vehicle auto-shut off timer operates**

when all the following conditions are satisfied:

- Vehicle speed is below 1.8 mph (3 km/h), and the gear is shifted to P (Park)
- The brake pedal and accelerator pedal are not depressed
- The driver's seat belt is unfastened  
The passenger seat is empty
- The infotainment system is being updated

#### **Deactivating conditions**

Vehicle Auto-Shut Off timer turns off when one of the situation occur:

- Vehicle speed is above 1.8 mph (3km/h)
- The gear is shifted to R (Reverse), D(Drive) or N (Neutral)
- The brake pedal or accelerator pedalis depressed
- The driver's seat belt is fastened
- A passenger is in the passenger's seat

### **System operation**

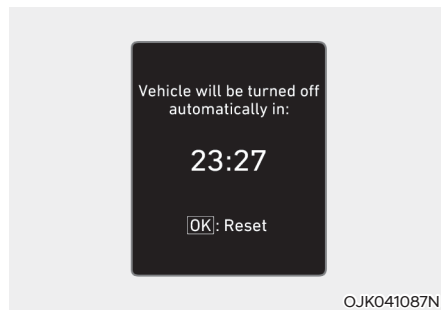

When all the conditions are satisfied, the Vehicle Auto-Shut Off operates and turns the engine off automatically after 60 minutes.

A timer appears on the instrument cluster 30 minutes before vehicle shut off.

### **Resetting cluster timer**

To reset the cluster timer, do one of the following:

- Release the accelerator pedal or brake pedal after Vehicle Auto-Shut Off is complete.
- Press the OK button on the steering wheel while the timer appears on the instrument cluster.



### **CAUTION**

**Do not leave a passenger or a pet in the vehicle in hot weather since the air conditioning system turns off when the engine is off.**

## AUTOMATIC TRANSMISSION

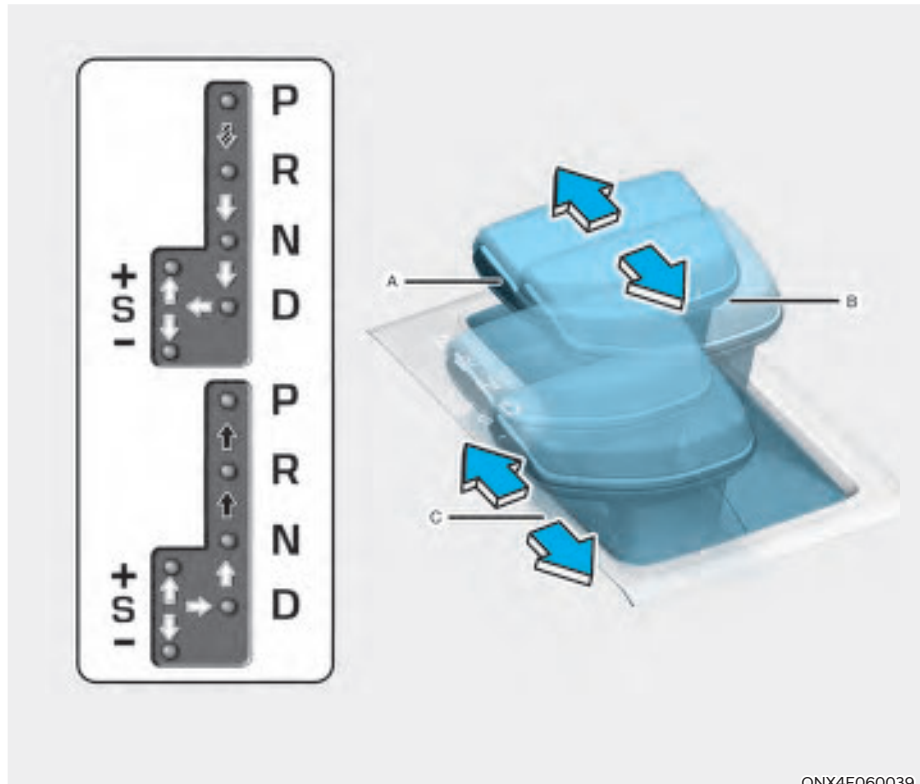

ONX4E060039

[A] : Shift lever, [B] : Shift release button, [C] : Manual shift mode

▨ Depress the brake pedal and press the Shift release button while moving the shift lever.

➡ Press the Shift release button while moving the shift lever.

⇨ The shift lever can freely operate.

### Automatic Transmission Operation

The automatic transmission has eight forward speeds and one reverse speed.

The individual speeds are selected automatically in the D (Drive) position.

The indicator in the instrument cluster displays the shift lever position when the ignition switch is in the ON position.



### WARNING

To reduce the risk of serious injury or death:

- **ALWAYS** check the surrounding areas near your vehicle for people, especially children, before shifting a vehicle into D (Drive) or R (Reverse).
- Before leaving the driver's seat, always make sure the shift lever is in the P (Park) position, then set the parking brake, and place the ignition switch in the LOCK/OFF position. Unexpected and sudden vehicle movement can occur if these precautions are not followed.
- When using the paddle shifter (manual shift mode), do not use engine braking (shifting from a high gear to lower gear) rapidly on slippery roads. The vehicle may slip causing an accident.

### **P (Park)**

Always come to a complete stop before shifting into P (Park).

To shift the vehicle from P (Park), make sure to depress firmly on the brake pedal and also make sure your foot is completely off the accelerator pedal.

**If you have done all of the above and still cannot shift the lever out of P (Park), see "Shift-Lock Release" in this chapter.**

The shift lever must be in P (Park) before turning the engine off.



### WARNING

- Shifting into P (Park) while the vehicle is in motion may cause you to lose control of the vehicle.
- After the vehicle has stopped, always make sure the shift lever is in P (Park), apply the parking brake, and turn the engine off.
- When parking on an incline, shift the gear to P (Park) and apply the parking brake to prevent the vehicle from rolling downhill.
- Do not use the P (Park) position in place of the parking brake.

### **R (Reverse)**

Use this position to drive the vehicle backward.

### **NOTICE**

Always come to a complete stop before shifting into or out of R (Reverse); you may damage the transmission if you shift into R (Reverse) while the vehicle is in motion.

Also note that when the vehicle is in D (Drive) or R (Reverse) and you open the driver's door, a warning will chime and a warning message "Shift to Park" will appear in the LCD cluster display.

### ***N (Neutral)***

The wheels and transmission are not engaged.

Use N (Neutral) if you need to restart a stalled engine, or if it is necessary to stop with the engine ON. Shift into P (Park) if you need to leave your vehicle for any reason.

Always depress the brake pedal when you are shifting from N (Neutral) to another gear.



### **WARNING**

**Make sure your foot is firmly depressing on the brake pedal when shifting into gear. Also, keep your foot off of the accelerator pedal when shifting into gear. Shifting when the engine rpm is high can cause the vehicle to move suddenly. You could lose control of the vehicle and serious injury could occur.**

### ***D (Drive)***

This is the normal driving position. The transmission will automatically shift through an 8-gear sequence, providing the best combination of fuel economy and power.

For extra power when passing another vehicle or driving uphill, continue to depress the accelerator pedal. You may notice the transmission downshift to the next lower gear or multiple gears as needed for the vehicle to accelerate sufficiently.

The DRIVE MODE switch, located on the shift lever console, allows the driver to switch between NORMAL mode, SPORT mode, or SMART mode.

**For more Details, refer to "Drive Mode Integrated Control System" later in this chapter.**

### Manual shift mode

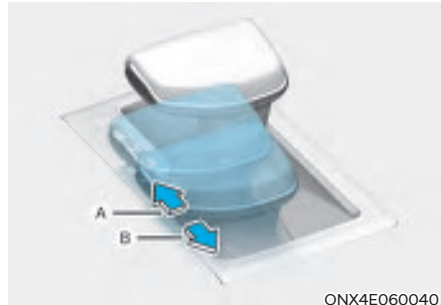

ONX4E060040

[A] : + (Up), [B] : - (Down)

Manual shift mode may be selected by simply toggling the shift lever to the left (toward the driver) into the manual shift gate. If your vehicle is currently in D (Drive), then the gear shift display in the instrument cluster will change from 'D' to the number of the current gear.

In manual shift mode, moving the shift lever backwards and forwards will allow you to select the desired range of gears for the current driving conditions.

+ (Up) : Push the lever forward once to shift up one gear.

- (Down) : Pull the lever backwards once to shift down one gear.

### **i** Information

- Only the eight forward gears can be selected. To reverse or park the vehicle, move the shift lever to the R (Reverse) or P (Park) position as required.
- Downshifts are made automatically when the vehicle slows down. When the vehicle stops, 1st gear is automatically selected.
- When the engine RPM approaches the red zone the transmission will upshift automatically.
- If the driver presses the lever to + (Up) or - (Down) position, the transmission may not make the requested gear change if the next gear is outside of the allowable engine RPM range. The driver must execute upshifts in accordance with road conditions, taking care to keep the engine RPMs below the red zone.
- When driving on a slippery road, push the shift lever forward into the + (Up) position. This causes the transmission to shift into the 2nd gear which is better for smooth driving on a slippery road. Push the shift lever to the - (Down) side to shift back to the 1st gear.

### **Shift-lock release**

If the shift lever cannot be moved from the P (Park) position into R (Reverse) position with the brake pedal depressed, continue depressing the brake, and then do the following:

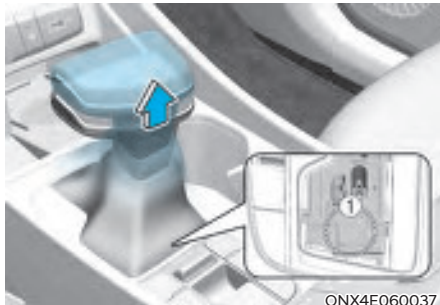

1. Place the ignition switch in the LOCK/OFF position.
2. Apply the parking brake.
3. Carefully remove the shift lever boots.
4. Move the Shift lever while holding the release button (1) with a tool (for example, flathead screw-driver).

If you need to use the shift-lock release, have your vehicle inspected by an authorized HYUNDAI dealer immediately.

### **Shift-lock system**

For your safety, the automatic transmission has a shift-lock system which prevents shifting the transmission from P (Park) into R (Reverse) unless the brake pedal is depressed.

To shift the transmission from P (Park) into R (Reverse):

1. Depress and hold the brake pedal.
2. Start the engine or place the ignition switch in the ON position.
3. Move the shift lever

### **Ignition key interlock system**

The ignition key cannot be removed unless the shift lever is in the P (Park) position.

### **Parking**

Always come to a complete stop and continue to depress the brake pedal. Move the shift lever into the P (Park) position, apply the parking brake, and place the ignition switch in the LOCK/OFF position. Take the Key with you when exiting the vehicle.



### **WARNING**

**When you stay in the vehicle with the engine running, be careful not to depress the accelerator pedal for a long period of time. The engine or exhaust system may overheat and start a fire.**

**The exhaust gas and the exhaust system are very hot. Keep away from the exhaust system components.**

**Do not stop or park over flammable materials, such as dry grass, paper or leaves. They may ignite and cause a fire.**



### Using the Paddle Shifters (if equipped)

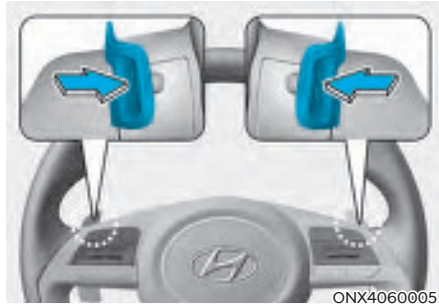

The paddle shifter is available when the shift lever is in the D (Drive) position or the manual shift mode.

#### With the shift lever in the D position

The paddle shifter will operate when the vehicle speed is more than 6mph.

Pull back on the [+] paddle (right side) to upshift or the [-] paddle (left side) to downshift. You will see the gear change in the LCD cluster display.

When using the paddle shifters and you wish to return from manual shift mode to 'D' Drive mode, do one of the following:

- Pull back on the [+] paddle (right side) for more than one second.
- Toggle the gear shift lever from 'D' (Drive) to the manual gate on the left side (towards the driver) and then toggle it back to the normal 'D' position.

The vehicle will automatically revert from paddle shifting manual shift mode to 'D' Drive mode if one of the following situations occur:

- When the accelerator pedal is gently depressed for more than 6 seconds while driving
- When the vehicle stops

#### **i** Information

**If the [+] and [-] paddle shifters are pulled at the same time, gear shift may not occur.**

### Good Driving Practices

- Never move the shift lever from P (Park) or N (Neutral) to any other position with the accelerator pedal depressed.
- Never move the shift lever into P (Park) when the vehicle is in motion. Be sure the vehicle is completely stopped before you attempt to shift into R (Reverse) or D (Drive).
- Do not move the shift lever to N (Neutral) when driving. Doing so may result in an accident because of a loss of engine braking and the transmission could be damaged.
- Driving uphill or downhill, shift to D (Drive) to drive forward or R (Reverse) to drive backwards, and check the gear position indicated on the cluster before driving. If the vehicle is moving in the opposite direction of the selected gear, the engine may stop and a serious accident may occur. Never attempt to select a gear that is opposite to the direction of the vehicle motion. Stop the vehicle before changing to the desired gear.
- Do not drive with your foot resting on the brake pedal. Even light, but consistent pedal pressure can result in the brakes overheating, brake wear and possibly even brake failure.
- When driving with shifter paddles, slow down before shifting to a lower gear. Otherwise, the lower gear may not be engaged if the engine RPMs are outside of the allowable range.
- Always apply the parking brake when leaving the vehicle. Do not depend on placing the transmission in P (Park) to keep the vehicle from moving.
- Exercise extreme caution when driving on a slippery surface. Be especially careful when braking, accelerating or shifting gears. On a slippery surface, an abrupt change in vehicle speed can cause the drive wheels to lose traction and may cause loss of vehicle control resulting in an accident.
- Optimum vehicle performance and economy is obtained by smoothly depressing and releasing the accelerator.



### WARNING

To reduce the risk of **SERIOUS INJURY** or **DEATH**:

- **ALWAYS wear your seatbelt. In a collision, an unbelted occupant is significantly more likely to be seriously injured or killed than a properly belted occupant.**
- **Avoid high speeds when cornering or turning.**
- **Do not make quick steering wheel movements, such as sharp lane changes or fast, sharp turns.**
- **The risk of rollover is greatly increased if you lose control of your vehicle at highway speeds.**
- **Loss of control often occurs if two or more wheels drop off the roadway and the driver over steers to reenter the roadway.**
- **In the event your vehicle leaves the roadway, do not steer sharply. Instead, slow down before pulling back into the travel lanes.**
- **HYUNDAI recommends you follow all posted speed limits.**

## DUAL CLUTCH TRANSMISSION (IF EQUIPPED)

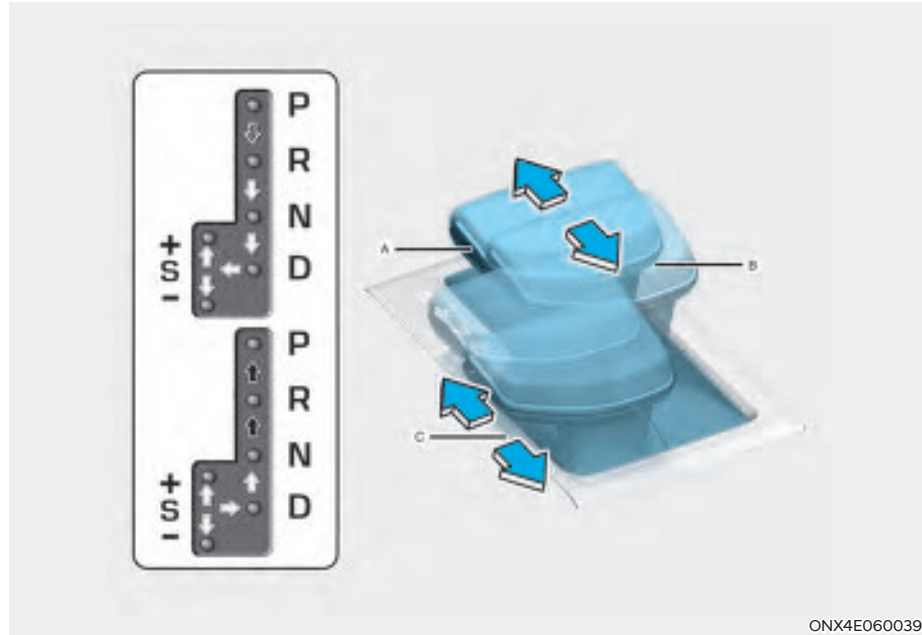

- Depress the brake pedal and press the shift button ahead of the shift lever while moving the shift lever.
- ➡ Press the shift button while moving the shift lever.
- ⇨ The shift lever can freely operate.

### Dual Clutch Transmission Operation

The dual clutch transmission has eight forward speeds and one reverse speed.

The individual speeds are selected automatically when the shift lever is in the D (Drive) position.

- The advanced wet-clutch dual clutch transmission in your vehicle can be thought of as an automatically shifting manual transmission. It gives the driving feel of a manual transmission, yet provides the ease of a fully automatic transmission.
- When D (Drive) is selected, the transmission will automatically shift through the gears similar to a conventional automatic transmission. With a wet-type dual clutch transmission, however, the engine torque that is transmitted directly from the engine to the transmission is transferred by a clutch pack that is lubricated in oil. The oil's primary purpose is to cool the clutch, and because of lubricating properties of the oil and this cooling effect, gear shifts are smooth as well as direct.
- The wet-type dual clutch transmission allows for better acceleration performance and increased fuel efficiency while driving. But it differs from a conventional automatic transmission because it does not incorporate a torque converter. Instead, the transition from one gear to the next is managed by clutch slip, especially at lower speeds.

As a result, shifts are sometimes more noticeable, and a light vibration can be felt as the transmission shaft speed is matched with the engine shaft speed. This is a normal condition of the dual clutch transmission.
- The wet-type clutch transfers torque more directly and provides a direct drive feeling which may feel different from a conventional automatic transmission. This may be more noticeable when launching the vehicle from a stop or when traveling at low, stop-and-go vehicle speeds.
- When rapidly accelerating from a lower vehicle speed, the engine rpm may increase dramatically as a result of clutch slip as the dual clutch transmission selects the correct gear. This is a normal condition.
- When accelerating from a stop on an incline, press the accelerator smoothly and gradually to avoid any shudder feeling or jerkiness.
- When traveling at a lower vehicle speed, if you release the accelerator pedal quickly, you may feel engine braking before the transmission changes gears. This engine braking feeling is similar to operating a manual transmission at low speed.
- When driving downhill, you may wish to move the gear shift lever to Manual Shift mode and downshift to a lower gear in order to control your speed without using the brake pedal excessively.
- When you turn the engine on and off, you may hear clicking sounds as the system goes through a self-test. This is a normal sound for the dual clutch transmission.
- During the first 1000 miles (1,500km), you may feel that the vehicle may not be smooth when accelerating at low speed. During this break-in period, the shift quality and performance of your new vehicle is continuously optimized.

### WARNING

To reduce the risk of serious injury or death:

- **ALWAYS** check the surrounding areas near your vehicle for people, especially children, before shifting a vehicle into D (Drive) or R (Reverse).
- Before leaving the driver's seat, always make sure the shift lever is in the P (Park) position, then set the parking brake, and place the ignition switch in the LOCK/OFF position. Unexpected and sudden vehicle movement can occur if these precautions are not followed.
- Do not use aggressive engine braking (shifting from a higher gear to a lower gear) on slippery roads. This could cause the tires to slip and may result in an accident.

### **NOTICE**

- Always come to a complete stop before shifting into D (Drive) or R (Reverse).
- Do not put the shift lever in N (Neutral) while driving.

### WARNING

Due to transmission failure, you may not continue to drive and the position indicator and the position indicator (D, P) on the instrument cluster will blink. Contact authorized HYUNDAI dealer and have the system checked.

### **DCT warning messages**

This warning message is displayed when vehicle is driven slowly on a grade and the vehicle detects that the brake pedal is not applied.

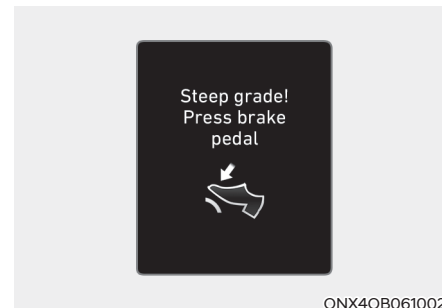

#### **Steep grade! Press brake pedal**

Driving up hills or on steep grades:

- To hold the vehicle on an incline use the foot brake or the parking brake.
- When in stop-and-go traffic on an incline, allow a gap to form ahead of you before moving the vehicle forward. Then hold the vehicle on the incline with the foot brake.
- If the vehicle is held or creeping forward on an incline by applying the accelerator pedal, the clutch and transmission may overheat which can result in damage. At this time, a warning message will appear on the LCD display.
- If the LCD warning is active, the foot brake must be applied.
- Ignoring the warnings can lead to damage to the transmission.



#### Transmission high temperature

- Under certain conditions, such as repeated stop-and-go launches on steep grades, sudden take off or acceleration, or other harsh driving conditions, the transmission clutch temperatures will increase excessively.
- When the clutch temperatures are too high, the “Transmission temp. is high! Stop safely” warning message will appear on the LCD display, a chime will sound, and the transmission shifting may not be smooth.
- If this occurs, pull over to a safe location, stop the vehicle with the engine running, apply the brakes and shift the vehicle to P (Park), and allow the transmission to cool.
- If you ignore this warning, the driving condition may become worse. You may experience abrupt shifts, frequent shifts, or jerkiness. To return to the normal driving condition, stop the vehicle and shift into P (Park). Then allow the transmission to cool for a few minutes with engine on before driving off.
- When possible, drive the vehicle smoothly.

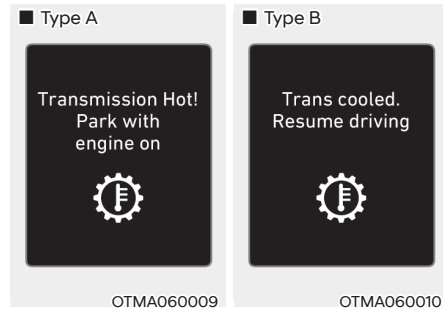

#### Transmission overheated

- If the vehicle continues to be driven and the clutch temperatures reach the maximum temperature limit, the “Transmission Hot! Park with engine on” warning will be displayed. When this occurs the clutch is disabled until the clutch cools to normal temperatures.
- The warning will display a time to wait for the transmission to cool.
- If this occurs, pull over to a safe location, stop the vehicle with the engine running, apply the brakes and shift the vehicle to P (Park), and allow the transmission to cool.
- When the message “Trans cooled. Resume driving” appears you can continue to drive your vehicle.
- When possible, drive the vehicle smoothly.

If any of the warning messages in the LCD display continue to blink, for your safety, contact an authorized HYUNDAI dealer and have the system checked.

### **Transmission ranges**

The indicator in the instrument cluster displays the shift lever position when the ignition switch is in the ON position.

#### **P (Park)**

Always come to a complete stop before shifting into P (Park).

To shift from P (Park), you must depress firmly on the brake pedal and make sure your foot is off the accelerator pedal.

**If you have done all of the above and still cannot shift the lever out of P (Park), see “Shift-Lock Release” in this chapter.**

The shift lever must be in P (Park) before turning the engine off.



#### **WARNING**

- **Shifting into P (Park) while the vehicle is in motion may cause you to lose control of the vehicle.**
- **After the vehicle has stopped, always make sure the shift lever is in P (Park), apply the parking brake, and turn the engine off.**
- **When parking on an incline, place the shift lever in P (Park) and apply the parking brake to prevent the vehicle from rolling downhill.**
- **For safety, always engage the parking brake with the shift lever in the P (Park) position except for the case of emergency parking.**

#### **R (Reverse)**

Use this position to drive the vehicle backward.

#### **NOTICE**

**Always come to a complete stop before shifting into or out of R (Reverse); you may damage the transmission if you shift into R (Reverse) while the vehicle is in motion.**

#### **N (Neutral)**

The wheels and transmission are not engaged.

Use N (Neutral) if you need to restart a stalled engine, or if it is necessary to stop with the engine ON. Shift into P (Park) if you need to leave your vehicle for any reason.

Always depress the brake pedal when you are shifting from N (Neutral) to another gear.



#### **WARNING**

**Do not shift into gear unless your foot is firmly on the brake pedal. Shifting into gear when the engine is running at high speed can cause the vehicle to move very rapidly. You could lose control of the vehicle and hit people or objects.**

### D (Drive)

This is the normal driving position. The transmission will automatically shift through a 8-gear sequence, providing the best fuel economy and power.

For extra power when passing another vehicle or driving uphill, depress the accelerator fully. The transmission will automatically downshift to the next lower gear (or gears, as appropriate).

The DRIVE MODE switch, located on the shift lever console, allows the driver to switch from NORMAL mode to SPORT mode.

**For more details, refer to “Drive Mode Integrated Control System” later in this chapter.**

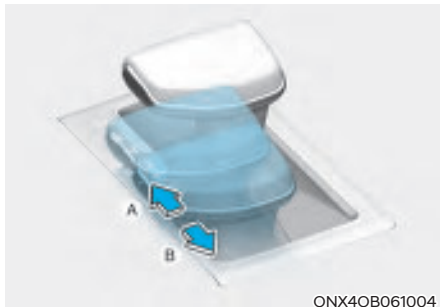

### Manual shift mode

Whether the vehicle is stationary or in motion, manual shift mode is selected by pushing the shift lever from the D (Drive) position into the manual gate. To return to D (Drive) range operation, push the shift lever back into the main gate.

In Manual Shift mode, moving the shift lever backwards (B) and forwards (A) will allow you to select the desired range of gears for the current driving conditions.

+ (Up) : Push the lever forward (A) once to shift up one gear.

- (Down) : Pull the lever backwards (B) once to shift down one gear.

### **i** Information

- **Only the eight forward gears can be selected in Manual Shift Mode. To reverse or park the vehicle, move the shift lever to the R (Reverse) or P (Park) position as required.**
- **Downshifts are made automatically when the vehicle slows down. When the vehicle stops, 1st gear is automatically selected.**
- **When the engine rpm approaches the red zone the transmission will upshift automatically.**
- **If the driver presses the lever to + (Up) or - (Down) position, the transmission may not make the requested gear change if the next gear is outside of the allowable engine rpm range. The driver must execute upshifts in accordance with road conditions, taking care to keep the engine rpms below the red zone.**

### **Shift-lock system**

For your safety, the dual clutch transmission has a shift-lock system which prevents shifting the transmission from P (Park) to R (Reverse) unless the brake pedal is depressed.

To shift the transmission from P (Park) into R (Reverse):

1. Depress and hold the brake pedal.
2. Start the engine or place the ignition switch in the ON position.
3. Move the shift lever to R (Reverse).



### Shift-lock release

If the shift lever cannot be moved from the P (Park) position into R (Reverse) position with the brake pedal depressed, continue depressing the brake, and then do the following:



1. Place the ignition switch in the LOCK/OFF position.
2. Apply the parking brake.
3. Carefully remove the shift lever boots.
4. Move the Shift lever while holding the release button (1) with a tool (for example, flathead screw-driver).

If you need to use the shift-lock release, we recommend that the system be inspected by an authorized HYUNDAI dealer immediately.

### Parking

Always come to a complete stop and continue to depress the brake pedal. Move the shift lever into the P (Park) position, apply the parking brake, and place the ignition switch in the LOCK/OFF position. Take the key with you when exiting the vehicle.

### Moving up a steep grade from a standing start

To move up a steep grade from a standing start, depress the brake pedal, shift the shift lever to D (Drive). Depress the accelerator pedal gradually while releasing the brake pedal.



### WARNING

**When you stay in the vehicle with the engine running, be careful not to depress the accelerator pedal for a long period of time. The engine or exhaust system may overheat and start a fire.**

**The exhaust gas and the exhaust system are very hot. Keep away from the exhaust system components.**

**Do not stop or park over flammable materials, such as dry grass, paper or leaves. They may ignite and cause a fire.**

### Good Driving Practices

- Never move the shift lever from P (Park) or N (Neutral) to any other position with the accelerator pedal depressed.
  - Never move the shift lever into P (Park) when the vehicle is in motion. Be sure the vehicle is completely stopped before you attempt to shift into R (Reverse) or D (Drive).
  - Do not move the shift lever to N (Neutral) when driving. Doing so may result in an accident because of a loss of engine braking and the transmission could be damaged.
  - Driving uphill or downhill, always shift to D (Drive) when driving forward or to R (Reverse) when driving backwards, and check the gear position indicated on the cluster before driving. If you drive in the opposite direction of the selected gear, the engine will turn off and a serious accident might be occurred due to the degraded brake performance.
  - Do not drive with your foot resting on the brake pedal. Even light, but consistent pedal pressure can result in the brakes overheating, brake wear and possibly even brake failure.
  - Depressing both accelerator and brake pedals at the same time can trigger logic for engine power reduction to assure vehicle deceleration. Vehicle acceleration will resume after the brake pedal is released.
  - When driving in Manual Shift mode, slow down before shifting to a lower gear. Otherwise, the lower gear may not be engaged if the engine rpms are outside of the allowable range.
  - When driving with shifter paddles, slow down before shifting to a lower gear. Otherwise, the lower gear may not be engaged if the engine rpms are outside of the allowable range.
- Always apply the parking brake when leaving the vehicle. Do not depend on placing the transmission in P (Park) to keep the vehicle from moving.
  - Exercise extreme caution when driving on a slippery surface. Be especially careful when braking, accelerating or shifting gears. On a slippery surface, an abrupt change in vehicle speed can cause the drive wheels to lose traction and may cause loss of vehicle control resulting in an accident.
  - Optimum vehicle performance and economy is obtained by smoothly depressing and releasing the accelerator.



### WARNING

To reduce the risk of **SERIOUS INJURY** or **DEATH**:

- **ALWAYS wear your seatbelt. In a collision, an unbelted occupant is significantly more likely to be seriously injured or killed than a properly belted occupant.**
- **Avoid high speeds when cornering or turning.**
- **Do not make quick steering wheel movements, such as sharp lane changes or fast, sharp turns.**
- **The risk of rollover is greatly increased if you lose control of your vehicle at highway speeds.**
- **Loss of control often occurs if two or more wheels drop off the roadway and the driver over steers to reenter the roadway.**
- **In the event your vehicle leaves the roadway, do not steer sharply. Instead, slow down before pulling back into the travel lanes.**
- **HYUNDAI recommends you follow all posted speed limits.**

## BRAKING SYSTEM

### Power-assist Brakes

Your vehicle has power-assisted brakes that adjust automatically through normal usage.

If the engine is not running or is turned off while driving, the power assist for the brakes will not work. You can still stop your vehicle by applying greater force to the brake pedal than typical. The stopping distance, however, will be longer than with power brakes.

When the engine is not running, the reserve brake power is partially depleted each time the brake pedal is applied. Do not pump the brake pedal when the power assist has been interrupted.



### WARNING

Take the following precautions:

- **Do not drive with your foot resting on the brake pedal. This will create abnormal high brake temperatures, excessive brake lining and pad wear, and increased stopping distances.**
- **When descending a long or steep hill, use the paddle shifter and manually downshift to a lower gear in order to control your speed without using the brake pedal excessively. Applying the brakes continuously will cause the brakes to overheat and could result in a temporary loss of braking performance.**

- **Wet brakes may impair the vehicle's ability to safely slow down; the vehicle may also pull to one side when the brakes are applied. Applying the brakes lightly will indicate whether they have been affected in this way. Always test your brakes in this fashion after driving through deep water. To dry the brakes, lightly tap the brake pedal to heat up the brakes while maintaining a safe forward speed until brake performance returns to normal. Avoid driving at high speeds until the brakes function correctly.**

### Disc Brakes Wear Indicator

When your brake pads are worn and new pads are required, you will hear a high pitched warning sound from your front or rear brakes. You may hear this sound come and go or it may occur whenever you depress the brake pedal.

Note that some driving conditions or climates may cause a brake squeal when you first apply (or lightly apply) the brakes. This is normal and does not indicate a problem with your brakes.

### NOTICE

**To avoid costly brake repairs, do not continue to drive with worn brake pads.**



### Information

**Always replace brake pads as complete front or rear axle sets.**

## Electronic Parking Brake (EPB) Applying the parking brake

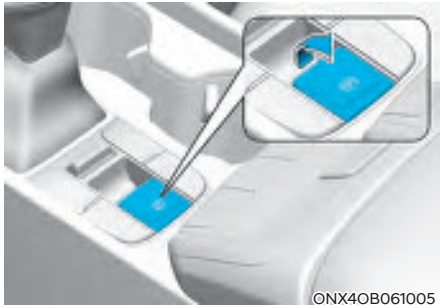

To apply EPB (Electronic Parking Brake):

1. Depress and hold the brake pedal.
2. Pull up the EPB switch.

Make sure the Parking Brake warning light comes on.

EPB (Electronic Parking Brake) may be automatically applied when:

- Requested by other systems
- The driver turns the vehicle off while Auto Hold is operating.

### Emergency braking

If there is a problem with the brake pedal while driving, emergency braking is possible by pulling up and holding the EPB switch. Braking is possible only while you are holding the EPB switch. However, braking distance will be longer than normal.

### **WARNING**

To reduce the risk of **SERIOUS INJURY** or **DEATH**, do not operate the EPB while the vehicle is moving except in an emergency situation. It could damage the brake system and lead to an accident.

### **Information**

During emergency braking, the Parking Brake warning light will illuminate to indicate that the system is operating.

### **NOTICE**

If you continuously notice a noise or burning smell when the EPB is used for emergency braking, have the system checked by an authorized HYUNDAI dealer.

### Releasing the parking brake

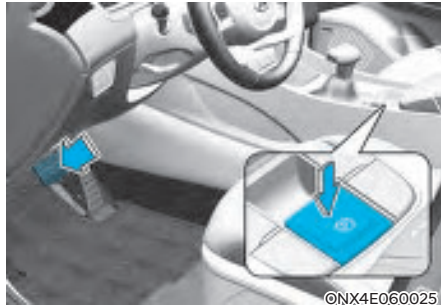

#### To release EPB (Electronic Parking Brake):

1. Press the Engine Start/Stop button to the ON or START position.
2. Press the EPB switch while depressing the brake pedal.

Make sure the Parking Brake warning light goes off.

#### To release EPB (Electronic Parking Brake) automatically:

- Gear in P (Park)

With the engine running depress the brake pedal and shift out of P (Park) to R (Reverse) or D (Drive).

- Gear in N (Neutral)

With the engine running depress the brake pedal and shift out of N (Neutral) to R (Reverse) or D (Drive).

- Satisfy the following conditions

1. Ensure the doors, hood and tailgate are closed.
2. With the engine running, depress the brake pedal and shift out of P (Park) to R (Reverse), D (Drive) or Manual shift mode.
3. Depress the accelerator pedal.  
Make sure the Parking Brake warning light goes off.

### **i** Information

- For your safety, you can engage EPB even though the Engine Stop/Start button is in the OFF position (only if battery power is available), but you cannot release it.
- For your safety, depress the brake pedal and release the parking brake manually with the EPB switch when you drive downhill or when backing up the vehicle.

### **NOTICE**

- If the Parking Brake warning light is still on even though the EPB has been released, have the system checked by an authorized HYUNDAI dealer.
- Do not drive your vehicle with EPB applied. It may cause excessive brake pad and brake rotor wear.

### Warning messages

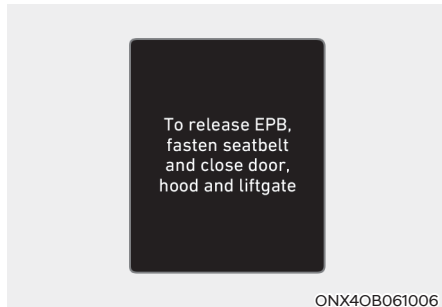

To release EPB, fasten seatbelt and close door, hood and tailgate

- If you try to drive with EPB applied, a warning will sound and a message will appear.
- If the driver's seat belt is unfastened and the engine hood or tailgate is opened, a warning will sound and a message will appear.
- If there is a problem with the vehicle, a warning may sound and a message may appear.

If the situation occurs, depress the brake pedal and release EPB by pressing the EPB switch.

### WARNING

- **Whenever leaving the vehicle or parking, always come to a complete stop and continue to depress the brake pedal.**  
**Shift the gear into P (Park), pull up the EPB switch, and press the Engine Start/Stop button to the OFF position. Take the Key with you when leaving the vehicle.**  
**Vehicles not fully engaged in P (Park) with the parking brake set are at risk for moving inadvertently and causing injury to yourself or others.**

- **NEVER** allow anyone who is unfamiliar with the vehicle to touch the EPB switch. If EPB is released unintentionally, serious injury may occur.
- Only release EPB when you are seated inside the vehicle with your foot firmly on the brake pedal.

### NOTICE

- Do not apply the accelerator pedal while the parking brake is engaged. If you depress the accelerator pedal with EPB engaged, a warning will sound and a message will appear. Damage to the parking brake may occur.
- Driving with the parking brake on can overheat the braking system and cause premature wear or damage to brake parts. Make sure EPB is released and the Parking Brake warning light is off before driving.

### Information

- A clicking sound may be heard while operating or releasing the EPB. These conditions are normal and indicate that EPB is functioning properly.
- When leaving your keys with a parking attendant or assistant, make sure to inform him/her how to operate EPB.

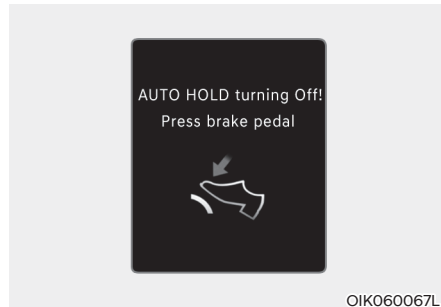

#### **AUTO HOLD turning Off! Press brake pedal**

When the conversion from Auto Hold to EPB is not working properly a warning will sound and a message will appear.

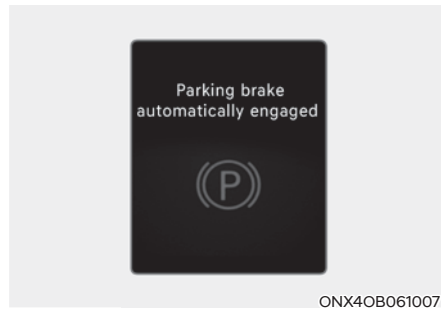

#### **Parking brake automatically engaged**

When EPB is applied while Auto Hold is activated, a warning will sound and a message will appear.

#### **EPB malfunction**

Electronic Parking Brake (EPB) warning light illuminates if the Engine Start/Stop button is pressed to the ON position and goes off in approximately 3 seconds if the system is operating normally.

If the EPB warning light remains on, comes on while driving, or does not come on when the Engine Start/Stop button is pressed to the ON position, this indicates that the EPB may have malfunctioned.



If this occurs, have the system checked by an authorized HYUNDAI dealer.

The EPB warning light may illuminate when the ESC indicator comes on to indicate that ESC is not working properly, but it does not indicate a malfunction of EPB.

#### **NOTICE**

- **If the EPB warning light is still on, have the system checked by an authorized HYUNDAI dealer.**
- **If the Parking Brake warning light does not illuminate or blinks even though the EPB switch was pulled up, EPB may not be applied.**
- **If the Parking Brake warning light blinks when the EPB warning light is on, press the switch, and then pull it up. Repeat this one more time. If the EPB warning does not go off, have the system checked by an authorized HYUNDAI dealer.**

### **Parking brake warning light**

  Check the Parking Brake warning light by pressing the Engine Stop/Start button to the ON position.

This light will be illuminated when the parking brake is applied with the ignition switch in the START or ON position.

Before driving, be sure the parking brake is released and the Parking Brake warning light is OFF.

If the Parking Brake warning light remains on after the parking brake is released while the engine is running, there may be a malfunction in the brake system. Immediate attention is necessary.

If at all possible, cease driving the vehicle immediately. If that is not possible, use extreme caution while operating the vehicle and only continue to drive the vehicle until you can reach a safe location.

### **Electronic Parking Brake (EPB) Malfunction**

If the Electronic Parking Brake (EPB) does not release normally, DO NOT DRIVE THE VEHICLE. Have your vehicle inspected at an authorized HYUNDAI dealer.

It is recommended to have your vehicle towed on a flatbed tow truck if the EPB malfunction occurs.

### **Auto Hold**

Auto Hold maintains the vehicle in a standstill even though the brake pedal is not depressed after the driver brings the vehicle to a complete stop by depressing the brake pedal.

#### **To apply:**



1. With the driver's door and engine hood closed, press the AUTO HOLD switch. The white AUTO HOLD indicator will come on and the system will be in the standby position.





2. When you stop the vehicle completely by depressing the brake pedal, Auto Hold maintains the brake pressure to hold the vehicle stationary. The indicator changes from white to green.
3. The vehicle will remain stationary even if you release the brake pedal.
4. If EPB is applied, Auto Hold will be released.

#### To release:

- If you depress the accelerator pedal with the gear in D(Drive) or Manual shift mode or R(vehicle equipped with shift button), the Auto Hold will be released automatically and the vehicle will start to move. The AUTO HOLD indicator changes from green to white.
- If the vehicle is restarted using the +/- switch operation while Auto Hold and Smart Cruise Control or Highway Driving Assist is operating, Auto Hold will be released regardless of accelerator pedal operation. The AUTO HOLD indicator changes from green to white.

#### **WARNING**

When Auto Hold is automatically released by depressing the accelerator pedal, always take a look around your vehicle.

Slowly depress the accelerator pedal for a smooth start.

#### To cancel:



1. Depress and hold the brake pedal.
  2. Press the AUTO HOLD switch.
- The AUTO HOLD indicator will turn off.

#### **WARNING**

To prevent, unexpected and sudden vehicle movement, **ALWAYS** press your foot on the brake pedal to cancel the Auto Hold before you:

- Drive downhill.
- Drive the vehicle in R (Reverse). (vehicle equipped with shift lever)
- Park the vehicle.

**i** Information

- The Auto Hold does not operate when:
  - The driver's door is opened
  - The engine hood is opened
  - The gear is in P (Park)
  - EPB is applied
  - Drive the vehicle in R (Reverse).
- For your safety, the Auto Hold automatically switches to EPB when:
  - The driver's door is opened
  - The engine hood is opened
  - The vehicle is in a standstill for more than 10 minutes
  - The vehicle is standing on a steep slope
  - The vehicle moved several times
  - Drive the vehicle in R (Reverse). (vehicle equipped with shift lever)

In these cases, the Parking Brake warning light comes on, the AUTO HOLD indicator changes from green to white, and a warning sound and a message will appear to inform you that EPB has been automatically engaged. Before driving off again, depress the brake pedal, check the surrounding area near your vehicle and release the parking brake manually with the EPB switch.

- While operating Auto Hold, you may hear mechanical noise. However, it is normal operating noise.

**NOTICE**

If the AUTO HOLD indicator changes to yellow, Auto Hold is not working properly. Contact an authorized HYUNDAI dealer.

**⚠** WARNING

- Depress the accelerator pedal slowly when you start the vehicle.
- For your safety, cancel Auto Hold when you drive downhill, back up the vehicle or park the vehicle.

**NOTICE**

If there is a malfunction with the driver's door or engine hood open detection system, Auto Hold may not work properly.

Contact an authorized HYUNDAI dealer.

### Warning messages

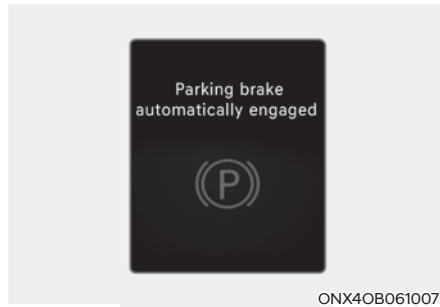

#### **Parking brake automatically engaged**

When EPB is applied while Auto Hold is activated, a warning will sound and a message will appear.

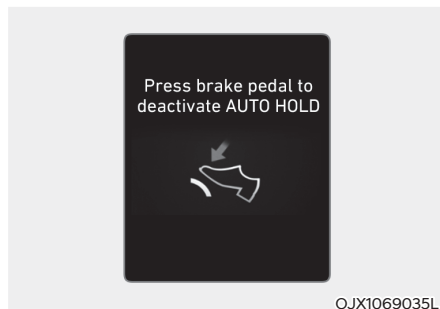

#### **Press brake pedal to deactivate AUTO HOLD**

If you did not apply the brake pedal when you release Auto Hold by pressing the AUTO HOLD switch, a warning will sound and a message will appear.



#### **AUTO HOLD conditions not met. Close door and hood.**

When you press the AUTO HOLD switch, if the driver's door and engine hood are not closed, a warning will sound and a message will appear on the cluster LCD display.

Press the AUTO HOLD switch after closing the driver's door and hood.

## Anti-lock Brake System (ABS)



### WARNING

**Anti-Lock Braking System (ABS) or Electronic Stability Control (ESC) system will not prevent accidents due to improper or dangerous driving maneuvers. Even though vehicle control is improved during emergency braking, always maintain a safe distance between you and objects ahead of you. Vehicle speeds should always be reduced during extreme road conditions. The braking distance for vehicles equipped with ABS or ESC may be longer than for those without these systems in the following road conditions.**

**Drive your vehicle at reduced speeds during the following conditions:**

- **Rough, gravel or snow-covered roads.**
- **On roads where the road surface is pitted or has different surface height.**
- **Tire chains are installed on your vehicle.**

**The safety features of ABS or ESC equipped vehicle should not be tested by high speed driving or cornering. This could endanger the safety of yourself or others.**

ABS is an electronic braking system that helps prevent a braking skid. ABS allows the driver to steer and brake at the same time.

## Using ABS

To obtain the maximum benefit from your ABS in an emergency situation, do not attempt to modulate your brake pressure and do not try to pump your brakes. Depress your brake pedal as hard as possible.

When you apply your brakes under conditions which may lock the wheels, you may hear sounds from the brakes, or feel a corresponding sensation in the brake pedal. This is normal and it means your ABS is active.

ABS does not reduce the time or distance it takes to stop the vehicle.

Always maintain a safe distance from the vehicle in front of you.

ABS will not prevent a skid that results from sudden changes in direction, such as trying to take a corner too fast or making a sudden lane change. Always drive at a safe speed for the road and weather conditions.

ABS cannot prevent a loss of stability. Always steer moderately when braking hard. Severe or sharp steering wheel movement can still cause your vehicle to veer into oncoming traffic or off the road.

On loose or uneven road surfaces, operation of the anti-lock brake system may result in a longer stopping distance than for vehicles equipped with a conventional brake system.

The ABS ((ABS)) warning light will stay on for several seconds after the ignition switch is in the ON position.

During that time, ABS will go through self-diagnosis and the light will go off if everything is normal. If the light stays on, you may have a problem with your ABS. Contact an authorized HYUNDAI dealer as soon as possible.

**⚠ WARNING**

If the ABS ((ABS)) warning light is on and stays on, you may have a problem with the ABS. Your power brakes will work normally. To reduce the risk of serious injury or death, contact your authorized HYUNDAI dealer as soon as possible.

**NOTICE**

When you drive on a road having poor traction, such as an icy road, and apply your brakes continuously, ABS will be active continuously and the ABS ((ABS)) warning light may illuminate. Pull your vehicle over to a safe place and turn the vehicle off.

**Restart the vehicle.** If the ABS warning light is off, then your ABS system is normal.

**Otherwise, you may have a problem with your ABS system. Contact an authorized HYUNDAI dealer as soon as possible.**

**i Information**

When you jump start your vehicle because of a drained battery, the ABS ((ABS)) warning light may turn on at the same time. This happens because of the low battery voltage. It does not mean your ABS is malfunctioning. Have the battery recharged before driving the vehicle.

**Electronic Stability Control (ESC)**

Electronic Stability Control helps to stabilize the vehicle during cornering maneuvers.

ESC checks where you are steering and where the vehicle is actually going. ESC applies braking pressure to any one of the vehicle's brakes and intervenes in the engine management system to assist the driver with keeping the vehicle on the intended path. It is not a substitute for safe driving practices. Always adjust your speed and driving to the road conditions.

**⚠ WARNING**

**Never drive too fast for the road conditions when cornering. ESC will not prevent accidents.**

**Excessive speed in turns, abrupt maneuvers, and hydroplaning on wet surfaces can result in severe accidents.**

### **ESC operation**

#### **ESC ON condition**

When the ignition switch is in the ON position, the ESC and the ESC OFF indicator lights illuminate for approximately three seconds. After both lights go off, the ESC is enabled.

#### **When operating**



When ESC is in operation, the ESC indicator light blinks:

- When you apply your brakes under conditions which may lock the wheels, you may hear sounds from the brakes, or feel a corresponding sensation in the brake pedal. This is normal and it means your ESC is active.
- When ESC activates, the engine may not respond to the accelerator as it does under routine conditions.
- If Cruise Control or Smart Cruise Control was in use when ESC activates, Cruise Control or Smart Cruise Control automatically disengages. Cruise Control or Smart Cruise Control can be reengaged when the road conditions allow. **See "Cruise Control (CC)" or "Smart Cruise Control (SCC)" section in chapter 7 (if equipped).**
- When moving out of the mud or driving on a slippery road, the engine RPM (revolutions per minute) may not increase even if you press the accelerator pedal deeply. This is to maintain the stability and traction of the vehicle and does not indicate a problem.

#### **ESC OFF condition**



To cancel ESC operation:

- **State 1**  
Press the ESC OFF button briefly. The ESC OFF indicator light and/or message 'Traction Control disabled' will illuminate. In this state, the traction control function of ESC (engine management) is disabled, but the brake control function of ESC (braking management) still operates.
- **State 2**  
Press and hold the ESC OFF button continuously for more than 3 seconds. The ESC OFF indicator light and/or message 'Traction & Stability Control disabled' illuminates and a warning chime sounds. In this state, both the traction control function of ESC (engine management) and the brake control function of ESC (braking management) are disabled.  
If the ignition switch is placed to the LOCK/OFF position when ESC is off, ESC remains off. Upon restarting the engine, the ESC will automatically turn on again.

### Indicator lights

- ESC indicator light (blinks)



- ESC OFF indicator light (comes on)



When the Engine Start/Stop button is pressed to the ON position, the ESC indicator light illuminates, then goes off if the ESC system is operating normally.

The ESC indicator light blinks whenever ESC is operating.

If the ESC indicator light stays on, your vehicle may have a malfunction with the ESC system. When this warning light illuminates we recommend that the vehicle be checked by an authorized HYUNDAI dealer as soon as possible.

The ESC OFF indicator light comes on when ESC is turned off.



### WARNING

When ESC is blinking, this indicates ESC is active:

Drive slowly and **NEVER** attempt to accelerate. **NEVER** turn ESC off while the ESC indicator light is blinking or you may lose control of the vehicle resulting in an accident.

### NOTICE

Driving with wheels and tires with different sizes may cause the ESC system to malfunction. Before replacing tires, make sure all four tires and wheels are the same size. Never drive the vehicle with different sized wheels and tires installed.

### ESC OFF usage

#### When Driving

The ESC OFF mode should only be used briefly to help free the vehicle if stuck in snow or mud, by temporarily stopping operation of ESC, to maintain wheel torque.

To turn ESC off while driving, press the ESC OFF button while driving on a flat road surface.

### NOTICE

To prevent damage to the transmission:

- Do not allow wheel(s) of one axle to spin excessively while the ESC, ABS, and Parking Brake warning lights are displayed. The repairs would not be covered by the vehicle warranty. Reduce engine power and do not spin the wheel(s) excessively while these lights are displayed.
- When operating the vehicle on a dynamometer, make sure ESC is turned off (ESC OFF light illuminated).



### Information

Turning ESC off does not affect ABS or standard brake system operation.

## Vehicle Stability Management (VSM)

Vehicle Stability Management is a function of the Electronic Stability Control (ESC) system. It helps the vehicle stay stable when accelerating or braking suddenly on wet, slippery and rough roads where traction over the four tires can suddenly become uneven.



### WARNING

Take the following precautions when using Vehicle Stability Management:

- **ALWAYS** check the speed and the distance to the vehicle ahead. VSM is not a substitute for safe driving practices.
- Never drive too fast for the road conditions. VSM will not prevent accidents. Excessive speed in bad weather, on slippery and uneven roads can result in severe accidents.

## VSM operation

### When operating

When you apply your brakes under conditions which may activate ESC, you may hear sounds from the brakes, or feel a corresponding sensation in the brake pedal. This is normal and it means your VSM is active.



### Information

VSM does not operate when:

- Driving on a banked road such as gradient or incline.
- Driving in reverse.
- The ESC OFF indicator light is on.
- The EPS (Electric power steering) warning light (⚠) is on or blinks.





#### VSM OFF condition

To cancel VSM operation, press the ESC OFF button. ESC OFF  indicator light will illuminate.

To turn on VSM, press the ESC OFF button again. The ESC OFF indicator light will go out.



#### WARNING

If the ESC  indicator light or EPS  warning light stays illuminated or blinks, your vehicle may have a malfunction with the VSM system. When the warning light illuminates have your vehicle checked by an authorized HYUNDAI dealer as soon as possible.

#### NOTICE

Driving with wheels and tires with different sizes may cause the VSM system to malfunction. Before replacing tires, make sure all four tires and wheels are the same size. Never drive the vehicle with different sized tires and wheels installed.

#### Trailer Stability Assist (TSA)

Trailer stability assist is operated as a vehicle stability control system. The Trailer stability assist system stabilizes the vehicle and trailer when the trailer sways or oscillates. Use caution when towing a trailer in high winds, which could cause your trailer to sway excessively. Also, reduce your highway speed while towing a trailer, especially when driving a downhill grade. The weight of the trailer behind your vehicle while driving on a downhill grade could cause the trailer to sway excessively.

Factors that may contribute to excessive trailer sway include:

- Higher vehicle speeds
- Strong crosswinds
- Improper or uneven loading of the trailer
- Sudden movements of the steering wheel in your vehicle
- Uneven or broken road conditions

The trailer stability assist system analyzes the vehicle and trailer condition while driving. If the system detects excessive sway from the trailer, the front brakes may be applied automatically to help stabilize the vehicle. In some cases the brakes may be applied on all wheels and the engine power may be reduced in order to minimize the sway condition.

### Hill-Start Assist Control (HAC)

Hill-Start Assist Control helps prevent the vehicle from rolling backwards when starting a vehicle from a stop on a hill. The system operates the brakes automatically for approximately 2 seconds and releases when the accelerator pedal is depressed.

#### **WARNING**

**Always be ready to depress the accelerator pedal when starting off an incline. Hill-Start Assist Control activates only for approximately 2 seconds.**

#### **Information**

- **Hill-Start Assist Control does not operate when the gear is shifted to P (Park) or N (Neutral).**
- **Hill-Start Assist Control activates even when the ESC (Electronic Stability Control) is off. However, it does not activate, when ESC does not operate normally.**

### Downhill Brake Control (DBC)

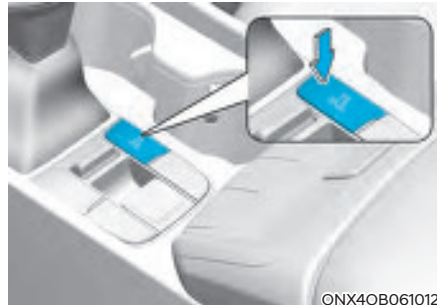





Downhill Brake Control assists the driver to descend down a steep hill without having to depress the brake pedal.

The system automatically applies the brakes to maintain vehicle speed below a certain speed and allows the driver to concentrate on steering the vehicle down hill.

The system is turned off whenever the engine is turned off.

Press the button to turn on the system and press the button again to turn it off.

**System operation**

Mode	Indicator	Description
Standby	 Green light on	Press the Downhill Brake Control button when vehicle speed is under 37 mph (60 km/h). Downhill Brake Control will turn on and enter the standby mode. The system does not turn on if vehicle speed is over 37 mph (60 km/h).
Activated	 Green light blink	In the standby mode, Downhill Brake Control will activate under the following conditions: <ul style="list-style-type: none"> <li>• The hill is steep enough.</li> <li>• The brake pedal or accelerator pedal is not depressed.</li> <li>• Vehicle speed is within 0~25 mph (0~40 km/h) range.</li> </ul> Within the activation speed range 2~25 mph (4~40 km/h), the driver can control the vehicle speed by depressing the brake pedal or accelerator pedal.
Deactivated	 Green light off	Downhill Brake Control will turn off under the following conditions: <ul style="list-style-type: none"> <li>• The Downhill Brake Control button is pressed again.</li> <li>• Vehicle speed is over 37 mph (60 km/h).</li> </ul>
	 Green light on	Downhill Brake Control will be deactivated but maintain the standby mode under the following conditions: <ul style="list-style-type: none"> <li>• The hill is not steep enough.</li> <li>• Vehicle speed is between 25~37 mph (40~60 km/h).</li> </ul>
System malfunction	 Yellow light on	The yellow warning light illuminates when the system may have malfunctioned or may not work properly during activation. If this occurs, Downhill Brake Control is deactivated. Have the system inspected by an authorized HYUNDAI dealer as soon as possible.

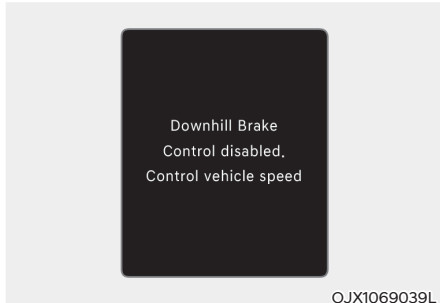

**Downhill Brake Control disabled. Control vehicle speed (manually)**

When Downhill Brake Control is not working properly this warning message will appear on the cluster LCD display and you will hear a warning sound. If this occurs, control vehicle speed by depressing the brake pedal.



**WARNING**

**Always turn off Downhill Brake Control on normal roads. The system might activate inadvertently from the standby mode when driving through speed bumps or making sharp curves.**

***i* Information**

- Downhill Brake Control may not deactivate on steep inclines even though the brake pedal or accelerator pedal is depressed.
- Downhill Brake Control may not always maintain vehicle speed at a certain speed.
- Downhill Brake Control does not operate when:
  - The gear is in P (Park).
  - ESC is activated.
- Noise or vibration may occur from the brakes when Downhill Brake Control is activated.
- The rear stop light comes on when Downhill Brake Control is activated.

## Good Braking Practices



### **WARNING**

**Whenever leaving the vehicle or parking, always come to a complete stop and continue to depress the brake pedal. Shift the gear to the P (Park) position, then apply the parking brake, and place the ignition switch in the LOCK/OFF position.**

**Vehicles parked with the parking brake not applied or not fully engaged may roll inadvertently and may cause injury to the driver and others. ALWAYS apply the parking brake before exiting the vehicle.**

Wet brakes can be dangerous! The brakes may get wet if the vehicle is driven through standing water or if it is washed. Your vehicle will not stop as quickly if the brakes are wet. Wet brakes may cause the vehicle to pull to one side.

To dry the brakes, apply the brakes lightly until the braking action returns to normal. If the braking action does not return to normal, stop as soon as it is safe to do so and call an authorized HYUNDAI dealer for assistance.

DO NOT drive with your foot resting on the brake pedal. Even light, but constant pedal pressure can result in the brakes overheating, brake wear, and possibly even brake failure.

If a tire goes flat while you are driving, apply the brakes gently and keep the vehicle pointed straight ahead while you slow down. When you are moving slowly enough for it to be safe to do so, pull off the road and stop in a safe location.

Keep your foot firmly on the brake pedal when the vehicle is stopped to prevent the vehicle from rolling forward.

## DRIVE MODE INTEGRATED CONTROL SYSTEM

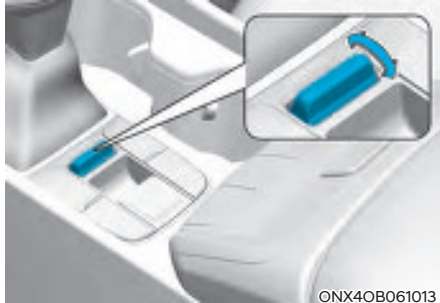

The drive mode may be selected according to the driver's preference or road condition.

The system resets to be in the NORMAL mode, when the engine is restarted.

### **i** Information

**If there is a problem with the instrument cluster, the drive mode will be in NORMAL mode and may not change to SPORT mode.**

The mode changes, as below, whenever the DRIVE MODE button is pressed or toggled.

NORMAL ↔ SPORT ↔ SMART ↔ SNOW (AWD)

NORMAL - SPORT - SMART (2WD)

### ***NORMAL mode***

In NORMAL mode the engine and transmission control logic work together to provide regular daily driving performance with some fuel efficiency.

- When NORMAL mode is selected, it is not displayed on the instrument cluster.

**SPORT mode**

**SPORT** SPORT mode provides sporty but firm riding.

In SPORT mode, the fuel efficiency may decrease.

- When SPORT mode is selected, the SPORT indicator will illuminate on the instrument cluster.
- Whenever the engine is restarted, the drive mode will revert back to NORMAL mode. If SPORT mode is desired, re-select SPORT mode.
- When SPORT mode is activated:
  - The engine RPM will tend to remain raised over a certain length of time even after releasing the accelerator
  - Upshifts are delayed when accelerating

**SMART mode**

**SMART** SMART mode selects the proper driving mode among, NORMAL and SPORT by judging the driver's driving habits (For example, mild or dynamic) from the brake pedal depression or the steering wheel operation.

- Press the DRIVE MODE button to activate SMART mode. When SMART mode is activated, the indicator illuminates on the instrument cluster.
- The vehicle starts in SMART mode, when the engine was turned OFF in SMART mode.
- SMART mode automatically controls gear shifting patterns, engine torque, in accordance with the driver's driving habits.

**SNOW mode**

**SNOW** SNOW mode offers special traction tuning for snow optimizing available traction in adverse conditions. Snow mode adjusts left and right wheel slip control, engine torque and shift patterns according to available traction levels.

**i Information**

- **When your vehicle drive mode is selected to SMART mode, the driving mode varies according to your acceleration pedal input. When your vehicle is in SMART mode and your driving style is such that your acceleration pedal input is gradual, the drive mode will maximize fuel efficiency. Note, however, the actual fuel efficiency may vary according to certain driving conditions (uphill/downhill grade) and vehicle speed.**
- **When your vehicle is in SMART mode and your driving style is more aggressive such that your acceleration pedal input is more abrupt, the drive mode will change to reflect a more SPORT driving characteristic. Note that while you are driving this way, fuel economy may be adversely affected.**

### **Various driving situations, which you may encounter in SMART mode**

- The driving mode automatically changes to SMART SPORT, when you abruptly accelerate the vehicle or repetitively operate the steering wheel (Your driving is categorized to be sporty.). In this mode, your vehicle drives in a lower gear for abrupt accelerating/decelerating and increases the engine brake performance.
- You may still sense the engine braking performance, even when you release the accelerator pedal in SMART SPORT mode. It is because your vehicle remains in lower gear over a certain period of time for next acceleration. Thus, it is a normal driving situation, not indicating any malfunction.
- The driving mode automatically changes to SMART SPORT mode only in harsh driving situations. In most of the normal driving situations, the driving mode sets to be in SMART NORMAL mode.

### **Limitation of SMART mode**

The SMART mode may be limited in following situations. (The OFF indicator illuminates in those situations.)

- The driver manually moves the shift lever : It deactivates SMART mode. The vehicle drives, as the driver manually moves the shift lever.
- The vehicle is driven using the paddle shifter (manual shift mode) : SMART mode is deactivated determining that the driver wants to drive the vehicle manually
- Cruise Control or Smart Cruise Control is activated : Cruise Control or Smart Cruise Control may deactivate the SMART mode. When a higher system is set by Cruise Control or Smart Cruise Control, it starts to control vehicle speed and deactivates SMART mode. (SMART mode is not deactivated just by activating Cruise Control or Smart Cruise Control.)
- The transmission oil temperature is either extremely low or extremely high : The SMART mode can be active in most of the normal driving situations. However, an extremely high/ low transmission oil temperature may temporarily deactivate the SMART mode, because the transmission condition is out of normal operation condition.



## ALL WHEEL DRIVE (AWD) (IF EQUIPPED)

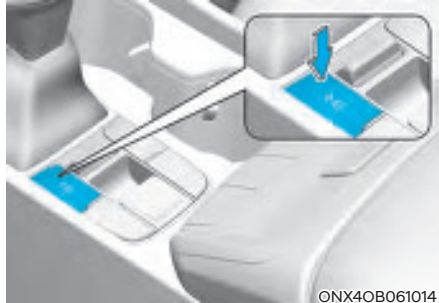

The All Wheel Drive (AWD) System delivers engine power to both the front and rear wheels for maximum traction. AWD is useful when extra traction is required on roads such as slippery, muddy, wet, or snow-covered roads.

Occasional off-road use such as established unpaved roads and trails are OK. It is always important that the driver carefully reduces the speed to a level that does not exceed the safe operating speed for those conditions.

### **WARNING**

To reduce the risk of **SERIOUS INJURY** or **DEATH**:



- Do not drive in conditions that exceed the vehicles intended design such as challenging off-road conditions.
- Avoid high speeds when cornering or turning.
- Do not make quick steering wheel movements, such as sharp lane changes or fast, sharp turns.
- The risk of a rollover is greatly increased if you lose control of your vehicle at highway speeds.
- Loss of control often occurs if two or more wheels drop off the roadway and the driver over steers to reenter the roadway.
- In the event your vehicle leaves the roadway, do not steer sharply. Instead, slow down before pulling back into the travel lanes.

### **NOTICE**



- Do not drive in water if the level is higher than the bottom of the vehicle.
- Check your brake condition once you are out of mud or water. Depress the brake pedal several times as you move slowly until you feel normal braking return.
- Shorten your scheduled maintenance interval if you drive in off-road conditions such as sand, mud or water (see "Maintenance Under Severe Usage Conditions" in chapter 7).
- Always wash your vehicle thoroughly after off road use, especially the bottom of the vehicle.
- Be sure to equip the vehicle with four tires of the same size and type.
- Make sure that a full time AWD vehicle is towed by a flat bed tow truck.

## AWD Operation

### Four Wheel Drive (AWD) mode selection

Transfer mode	Selection button	Indicator light	Description
<p><b>AWD AUTO</b> (AWD LOCK is deactivated)</p>		 (not illuminated)	<ul style="list-style-type: none"> <li>• AWD Auto is used when driving on roads in normal conditions, roads in urban areas, and on highways.</li> <li>• All wheels provide traction when the vehicle travels at a constant speed. But the AWD computer will vary front and rear wheel traction depending on road driving conditions, which will be automatically controlled by the computing system.</li> <li>• When the cluster's AWD Auto display mode is selected, the cluster displays the status of how four wheels' traction forces are distributed.</li> </ul>
<p><b>AWD LOCK</b></p>		 (illuminated)	<ul style="list-style-type: none"> <li>• The main goal of AWD Lock mode is to allow a driver to maximize the vehicle's traction under extreme driving conditions such as unpaved off-road, sandy roads, and muddy roads.</li> <li>• AWD Lock mode is in operation only when a vehicle travels at 37 mph (60 km/h) or less. When traveling at 37 mph (60 km/h) or faster, the mode will switch to AWD Auto.</li> <li>• When AWD Lock mode illuminates, the cluster does not display the front/rear wheel traction force distribution status.</li> <li>• Press the AWD Lock mode switch again to switch back to AWD Auto.</li> </ul>

**WARNING**

If AWD warning light (  ) stays on the instrument cluster, your vehicle may have a malfunction with the AWD system. When the AWD warning light (  ) illuminates have the vehicle checked by an authorized HYUNDAI dealer as soon as possible.

**NOTICE**

- Maintain AWD Auto mode when driving on roads in normal conditions.
- When driving under normal road conditions (especially when cornering) in AWD Lock mode, a driver may find minor mechanical vibration or noise, which is extremely normal phenomenon, not a malfunction. When AWD Lock mode is released, such noise or vibration will be immediately gone.

**CAUTION**

When driving on normal roads, deactivate the AWD LOCK mode by pushing the AWD LOCK button (AWD LOCK indicator light goes off). Driving on normal roads with the AWD LOCK mode, especially, when cornering may cause mechanical noise or vibration. The noise and vibration will disappear when the AWD LOCK mode is deactivated. Prolong driving with the noise and vibration may damage some parts of the power train.

**NOTICE**

When the AWD LOCK mode is deactivated, a sensation may be felt as the driving power is delivered entirely to the front wheels.

**For safe AWD operation****Before driving**

- Make sure all passengers are wearing seat belts.
- Sit upright and closer to the steering wheel than usual. Adjust the steering wheel to a position comfortable for you to drive.

**Driving on snow-covered or icy roads**

- Start off slowly by applying the accelerator pedal gently.
- Use snow tires or tire chains.
- Keep sufficient distance between your vehicle and the vehicle in front of you.
- Use engine braking during deceleration.
- Avoid speeding, rapid acceleration, sudden brake applications, and sharp turns to prevent skids.

**Driving in sand or mud**

- Maintain slow and constant speed.
- Use tire chains driving in mud if necessary.
- Keep sufficient distance between your vehicle and the vehicle in front of you.
- Reduce vehicle speed and always check the road condition.
- Avoid speeding, rapid acceleration, sudden brake applications, and sharp turns to prevent getting stuck.

**CAUTION**

When the vehicle is stuck in snow, sand or mud, place a non-slip material under the drive wheels to provide traction OR Slowly spin the wheels in forward and reverse directions which causes a rocking motion that may free the vehicle. However, avoid running the engine continuously at high RPM. Doing so may damage the AWD system.

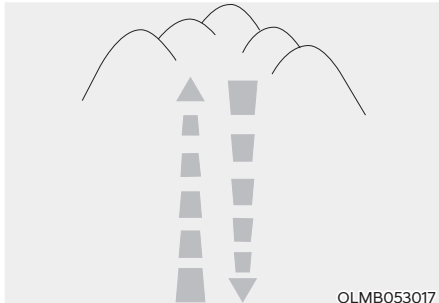

### Driving up or down hills

- Driving uphill
  - Before starting off, check if it is possible to drive uphill.
  - Drive as straight as possible.
- Driving downhill
  - Do not change gear while driving downhill. Select gear before driving downhill.
  - Drive as slowly using engine braking while driving downhill.
  - Drive straight as possible.



### WARNING

**Exercise extreme caution driving up or down steep hills. The vehicle may flip depending on the grade, terrain and water/ mud conditions.**



### WARNING

**Do not drive across the contour of steep hills. A slight change in the wheel angle can destabilize the vehicle, or a stable vehicle may lose stability if the vehicle stops its forward motion. Your vehicle may roll over and lead to a serious injury or death.**

### Driving through water

- Try to avoid driving in deep standing water. It may stall your engine and clog your exhaust pipes.
- If you need to drive in water, stop your vehicle, set the vehicle in AWD LOCK mode and drive under 5 mph (8 km/h).
- Do not change gear while driving in water.

### Additional driving conditions

- Become familiar with the off-road conditions before driving.
- Always pay attention when driving off-road and avoid dangerous areas.
- Drive slowly when driving in heavy wind.
- Reduce vehicle speed when cornering. The center of gravity of AWD vehicles is higher than conventional 2WD vehicles, making them more likely to roll over when you rapidly turn corners.



ONX4E060022

- Always hold the steering wheel firmly when you are driving off-road.

**WARNING**

Do not grab the inside of the steering wheel when you are driving off-road. You may hurt your arm by a sudden steering maneuver or from steering wheel rebound due to an impact with objects on the ground. You could lose control of the steering wheel which may lead to serious injury or death.

**Emergency Precautions****Tires**

Do not use tire and wheel with different size and type from the one originally installed on your vehicle. It can affect the safety and performance of your vehicle, which could lead to steering failure or rollover causing serious injury.

When replacing the tires, be sure to equip all four tires with the tire and wheel of the same size, type, tread, brand and load-carrying capacity. If you equip your vehicle with any tire/wheel combination not recommended by HYUNDAI for off-road driving, you should not use these tires for highway driving.

**WARNING**

Never start or run the engine while a full-time AWD vehicle is raised on a jack. The vehicle can slip or roll off of a jack causing serious injury or death to you or those nearby.

**Towing**

AWD vehicles must be towed with a wheel lift and dollies or flatbed equipment with all the wheels off the ground. For more details, refer to "Towing" in chapter 8.

**Dynamometer testing**

A full-time AWD vehicle must be tested on a special four wheel chassis dynamometer.

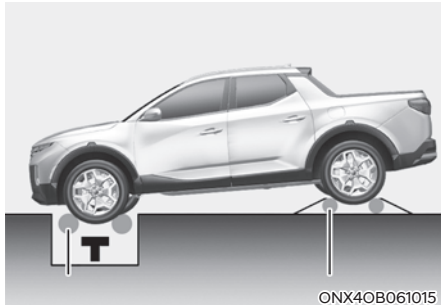

A full-time AWD vehicle should not be tested on a 2WD roll tester. If a 2WD roll tester must be used, perform the following procedure:

1. Check the tire pressures recommended for your vehicle.
2. Place the front wheels on the roll tester for a speedometer test as shown in the illustration.
3. Release the parking brake.
4. Place the rear wheels on the temporary free roller as shown in the illustration.

### CAUTION

- Never engage the parking brake while performing the test.
- When the vehicle is lifted up, do not operate the front and rear wheel separately. All four wheels should be operated.

### WARNING

Keep away from the front of the vehicle while the vehicle is in gear on the dynamometer. The vehicle can jump forward and cause serious injury or death.

## SPECIAL DRIVING CONDITIONS

### Hazardous Driving Conditions

When hazardous driving elements are encountered such as water, snow, ice, mud and sand, take the following precautions:

- Drive cautiously and maintain a longer braking distance.
- Avoid abrupt braking or steering.
- When your vehicle is stuck in snow, mud, or sand, use second gear. Accelerate slowly to avoid unnecessary wheel spin.
- Put sand, rock salt, tire chains or other non-slip materials under the wheels to provide additional traction while the vehicle becomes stuck in ice, snow, or mud.



#### WARNING

Downshifting with an automatic transmission while driving on slippery surfaces can cause an accident. The sudden change in tire speed could cause the tires to skid. Be careful when downshifting on slippery surfaces.

### Rocking the Vehicle

If it is necessary to rock the vehicle to free it from snow, sand, or mud, first turn the steering wheel right and left to clear the area around your front wheels. Then, shift back and forth between R (Reverse) and a forward gear.

Try to avoid spinning the wheels, and do not race the engine.

To prevent transmission wear, wait until the wheels stop spinning before shifting gears. Release the accelerator pedal while shifting, and press lightly on the accelerator pedal while the transmission is in gear. Slowly spinning the wheels in forward and reverse directions causes a rocking motion that may free the vehicle.



#### WARNING

If the vehicle is stuck and excessive wheel spin occurs, the temperature in the tires can increase very quickly. If the tires become damaged, a tire blow out or tire explosion can occur. This condition is dangerous - you and others may be injured. Do not attempt this procedure if people or objects are anywhere near the vehicle.

If you attempt to free the vehicle, the vehicle can overheat quickly, possibly causing an engine compartment fire or other damage. Try to avoid spinning the wheels as much as possible to prevent overheating of either the tires or the engine. **DO NOT** allow the vehicle to spin the wheels above 35 mph (56 km/h).



#### Information

The ESC system must be turned OFF before rocking the vehicle.

**NOTICE**

**If you are still stuck after rocking the vehicle a few times, have the vehicle pulled out by a tow vehicle to avoid engine overheating, possible damage to the transmission, and tire damage. See “Towing” section in chapter 8.**

**Smooth Cornering**

Avoid braking or gear changing in corners, especially when roads are wet. Ideally, corners should always be taken under gentle acceleration.

**Driving at Night**

Night driving presents more hazards than driving in the daylight. Here are some important tips to remember:

- Slow down and keep more distance between you and other vehicles, as it may be more difficult to see at night, especially in areas where there may not be any street lights.
- Adjust your mirrors to reduce the glare from other drivers' headlamps.
- Keep your headlamps clean and properly aimed. Dirty or improperly aimed headlamps will make it much more difficult to see at night.
- Avoid staring directly at the headlamps of oncoming vehicles. You could be temporarily blinded, and it will take several seconds for your eyes to readjust to the darkness.

**Driving in the Rain**

Rain and wet roads can make driving dangerous. Here are a few things to consider when driving in the rain or on slick pavement:

- Slow down and allow extra following distance. A heavy rainfall makes it harder to see and increases the distance needed to stop your vehicle.
- Turn OFF your Cruise Control. (if equipped)
- Replace your windshield wiper blades when they show signs of streaking or missing areas on the windshield.
- Be sure your tires have enough tread. If your tires do not have enough tread, making a quick stop on wet pavement can cause a skid and possibly lead to an accident. **See “Tire Tread” section in chapter 9.**
- Turn on your headlamps to make it easier for others to see you.
- Driving too fast through large puddles can affect your brakes. If you must go through puddles, try to drive through them slowly.
- If you believe your brakes may be wet, apply them lightly while driving until normal braking operation returns.

**Hydroplaning**

If the road is wet enough and you are going fast enough, your vehicle may have little or no contact with the road surface and actually ride on the water. The best advice is SLOW DOWN when the road is wet.

**The risk of hydroplaning increases as the depth of tire tread decreases, refer to “Tire Tread” section in chapter 9.**



### Driving in Flooded Areas

Avoid driving through flooded areas unless you are sure the water is no higher than the bottom of the wheel hub. Drive through any water slowly. Allow adequate stopping distance because brake performance may be reduced.

After driving through water, dry the brakes by gently applying them several times while the vehicle is moving slowly.

### Highway Driving

#### Tires

Adjust the tire inflation, as specified. Under-inflation may overheat or damage the tires.

Do not install worn-out or damaged tires, which may reduce traction or fail the braking operation.

#### Information

**Never over-inflate your tires above the maximum inflation pressure, as specified on your tires.**

#### **Fuel, engine coolant and engine oil**

Driving at higher speeds on the highway consumes more fuel and is less efficient than driving at a slower, more moderate speed. Maintain a moderate speed in order to conserve fuel when driving on the highway.

Be sure to check both the engine coolant level and the engine oil before driving.

#### **Drive belt**

A loose or damaged drive belt may overheat the engine.

### Reducing the Risk of a Rollover

Your multi-purpose passenger vehicle is defined as a Sports Utility Vehicle (SUV). SUV's have higher ground clearance and a narrower track to make them capable of performing in a wide variety of off-road applications. The specific design characteristics give them a higher center of gravity than ordinary vehicles making them more likely to roll over if you make abrupt turns. Utility vehicles have a significantly higher rollover rate than other types of vehicles. Due to this risk, driver and passengers are strongly recommended to buckle their seat belts. In a rollover crash, an unbelted person is significantly more likely to die than a person wearing a seat belt.

There are steps that a driver can make to reduce the risk of a rollover. If at all possible, avoid sharp turns or abrupt maneuvers, do not load your vehicle with heavy cargo on the roof, and never modify your vehicle in any way.

#### WARNING

**Utility vehicles have a significantly higher rollover rate than other types of vehicles. To prevent rollovers or loss of control:**

- **Take corners at slower speeds than you would with a passenger vehicle.**
- **Avoid sharp turns and abrupt maneuvers.**
- **Do not modify your vehicle in any way that you would raise the center of gravity.**
- **Keep tires properly inflated.**
- **Do not carry heavy cargo on the roof.**

#### WARNING

**In a rollover crash, an unbelted person is significantly more likely to die than a person wearing a seat belt. Make sure all passengers are wearing their seat belts.**

## WINTER DRIVING

The severe weather conditions of winter quickly wear out tires and cause other problems. To minimize winter driving problems, you should take the following suggestions:

### Snow or Icy Conditions

You need to keep sufficient distance between your vehicle and the vehicle in front of you.

Apply the brakes gently. Speeding, rapid acceleration, sudden brake applications, and sharp turns are potentially very hazardous practices. During deceleration, use engine braking to the fullest extent. Sudden brake applications on snowy or icy roads may cause the vehicle to skid.

To drive your vehicle in deep snow, it may be necessary to use snow tires or to install tire chains on your tires.

Always carry emergency equipment. Some of the items you may want to carry include tire chains, tow straps or chains, a flashlight, emergency flares, sand, a shovel, jumper cables, a window scraper, gloves, ground cloth, coveralls, a blanket, etc.

### Snow tires



#### WARNING

**Snow tires should be equivalent in size and type to the vehicle's standard tires. Otherwise, the safety and handling of your vehicle may be adversely affected.**

Use snow tires when road temperature is below 45°F (7°C). Refer to the below chart, and mount the recommended snow tire for your vehicle.

If you mount snow tires on your vehicle, make sure to use the same Inflation pressure as the original tires. Mount snow tires on all four wheels to balance your vehicle's handling in all weather conditions. The traction provided by snow tires on dry roads may not be as high as your vehicle's original equipment tires. Check with the tire dealer for maximum speed recommendations.

### Tire chains



ONX40B061017

Since the sidewalls of radial tires are thinner than other types of tires, they may be damaged by mounting some types of tire chains on them. Therefore, the use of snow tires is recommended instead of tire chains. If tire chains must be used, use genuine HYUNDAI Parts and install the tire chain after reviewing the instructions provided with the tire chains. Damage to your vehicle caused by improper tire chain use is not covered by your vehicle manufacturer's warranty.

245/60R18	Fabric-type
245/50R20	

When using tire chains, attach them to the drive wheels as follows.

2WD : Front wheels

AWD : All four wheels

If a full set of chains is not available for an AWD vehicle, chains may be installed on the front wheels only.



### WARNING

The use of tire chains may adversely affect vehicle handling:

- Drive less than 20 mph (30 km/h) or the chain manufacturer's recommended speed limit, whichever is lower.
- Drive carefully and avoid bumps, holes, sharp turns, and other road hazards, which may cause the vehicle to bounce.
- Avoid sharp turns or locked wheel braking.



### Information

- Install tire chains only in pairs and on the front tires. It should be noted that installing tire chains on the tires will provide a greater driving force, but will not prevent side skids.
- Do not install studded tires without first checking local and municipal regulations for possible restrictions against their use.

### Chain Installation

When installing tire chains, follow the manufacturer's instructions and mount them as tightly possible. Drive slowly (less than 20 mph (30 km/h)) with chains installed. If you hear the chains contacting the body or chassis, stop and tighten them. If they still make contact, slow down until the noise stops. Remove the tire chains as soon as you begin driving on cleared roads.

When mounting snow chains, park the vehicle on level ground away from traffic. Turn on the vehicle Hazard Warning Flasher and place a triangular emergency warning device behind the vehicle (if available). Always place the vehicle in P (Park), apply the parking brake and turn off the engine before installing snow chains.

### **NOTICE**

#### When using tire chains:

- **Wrong size chains or improperly installed chains can damage your vehicle's brake lines, suspension, body and wheels.**
- **Use SAE "S" class or wire chains.**
- **If you hear noise caused by chains contacting the body, retighten the chain to prevent contact with the vehicle body.**
- **To prevent body damage, retighten the chains after driving 0.3~0.6 miles (0.5~1.0 km).**
- **Do not use tire chains on vehicles equipped with aluminum wheels. If unavoidable, use a wire type chain.**
- **Use wire chains less than 0.47 in. (12mm) thick to prevent damage to the chain's connection.**

### Winter Precautions

#### Use high quality ethylene glycol coolant

Your vehicle is delivered with high quality ethylene glycol coolant in the cooling system. It is the only type of coolant that should be used because it helps prevent corrosion in the cooling system, lubricates the water pump and prevents freezing. Be sure to replace or replenish your coolant in accordance with the maintenance schedule in chapter 9. Before winter, have your coolant tested to assure that its freezing point is sufficient for the temperatures anticipated during the winter.

#### Check battery and cables

Winter temperatures affect battery performance. **Inspect the battery and cables, as specified in chapter 9.** The battery charging level can be checked by an authorized HYUNDAI dealer or in a service station.

#### Change to "winter weight" oil if necessary

In some regions during winter, it is recommended to use the "winter weight" oil with lower viscosity. In addition, replace the engine oil and filter if it is close to the next maintenance interval. Fresh engine oil ensures optimum engine operation during the winter months. For further information, refer to chapter 2. When you are not sure about a type of winter weight oil, consult an authorized HYUNDAI dealer.

**Check spark plugs and ignition system**

**Inspect the spark plugs, as specified in chapter 8.** If necessary, replace them. Also check all ignition wirings and components for any cracks, wear-out, and damage.

**To prevent locks from freezing**

To prevent the locks from being frozen, spray approved de-icing fluid or glycerin into key holes. When a lock opening is already covered with ice, spray approved de-icing fluid over the ice to remove it. When an internal part of a lock freezes, try to thaw it with a heated key. Carefully use the heated key to avoid an injury.

**Use approved window washer anti-freeze solution in system**

To prevent the window washer from being frozen, add authorized window washer anti-freeze solution, as specified on the window washer container. Window washer anti-freeze solution is available from an authorized HYUNDAI dealer, and most vehicle accessory outlets. Do not use engine coolant or other types of anti-freeze solution, to prevent any damage to the vehicle paint.

**Do not let your parking brake freeze**

Under some conditions your parking brake can freeze in the engaged position. This is most likely to happen when there is an accumulation of snow or ice around or near the rear brakes or if the brakes are wet. When there is the risk that your parking brake may freeze, temporarily apply it with the gear in P (Park). Also, block the rear wheels in advance, so the vehicle may not roll. Then, release the parking brake.

**Do not let ice and snow accumulate underneath**

Under some conditions, snow and ice can build up under the fenders and interfere with the steering. When driving in such conditions during the severe winter, you should check underneath the vehicle on a regular basis, to ensure that the front wheels and the steering components is unblocked.

**Carry emergency equipment**

In accordance with weather conditions, you should carry appropriate emergency equipment, while driving. Some of the items you may want to carry include tire chains, tow straps or chains, flashlight, emergency flares, sand, shovel, jumper cables, window scraper, gloves, ground cloth, coveralls, blanket, etc.

**Do not place objects or materials in the engine compartment**

Putting objects or materials in the engine compartment may cause an engine failure or combustion, because they may block the engine cooling. Such damage will not be covered by the manufacturer's warranty.

## TRAILER TOWING

If you are considering towing with your vehicle, be sure to take extra precautions while driving. Only experienced drivers should consider towing. Plan your trip accordingly as vehicle speed limits for vehicles towing trailers may be different. Always follow posted speed limits for vehicles towing with trailers.

Remember that trailering is different than just driving your vehicle by itself. Trailering means changes in handling, durability, and fuel economy. Successful, safe trailering requires correct equipment, and it has to be used properly. Damage to your vehicle caused by improper trailer towing is not covered by your vehicle manufacturer's warranty.

This section contains time-tested, important trailering tips and safety rules. Many of these are important for your safety and that of your passengers. Please read this section carefully before you pull a trailer.

### WARNING

Take the following precautions:

- **If you don't use the correct equipment and/or drive improperly, you can lose control of the vehicle when you are pulling a trailer. For example, if the trailer is too heavy, the braking performance may be reduced. You and your passengers could be seriously or fatally injured. Pull a trailer only if you have followed all the steps in this section.**
- **Before towing, make sure the total trailer weight, GCW (Gross Combination Weight), GVW (Gross Vehicle Weight), GAW (Gross Axle Weight) and trailer tongue load are all within the limits.**

### Information

Your vehicle can tow a trailer if you carefully observe the load limits, use the proper equipment, and follow the towing guidelines. See the Owner's Manual at <https://owners.hyundaiusa.com> (U.S.) for more information.

## Trailer Towing - Important Information

Here are some important points if you decide to pull a trailer:

- Consider using a trailer hitch that incorporates sway control through the use of anti-sway bars. Consult your trailer hitch dealer about the different types of sway control trailer hitches for your vehicle and trailer.
- Do not do any towing with your vehicle during its first 1,200 miles (2,000 km) in order to allow the engine to properly break in. Failure to heed this caution may result in serious engine or transmission damage.
- When towing a trailer, consult an authorized HYUNDAI dealer for further information on additional requirements such as a towing kit, etc.
- Always drive your vehicle at a moderate speed (less than 60 mph (100 km/h)) or posted towing speed limit.
- On a long uphill grade, do not exceed 45 mph (70 km/h) or the posted towing speed limit, whichever is lower.
- Carefully observe the weight and load limits provided in the following pages.

### Trailer weight

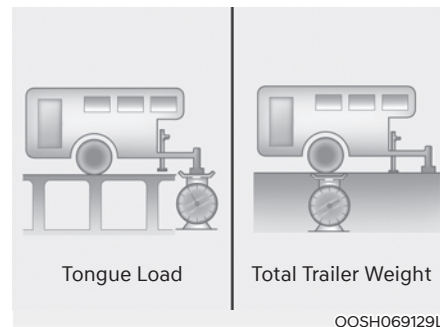

What is the maximum safe weight of a trailer? It should never weigh more than the maximum trailer weight with trailer brakes. But even that can be too heavy. It depends on how you plan to use your trailer. For example, speed, altitude, road grades, outside temperature and how often your vehicle is used to pull a trailer are all important. The ideal trailer weight can also depend on any special equipment that you have on your vehicle.

### Tongue load

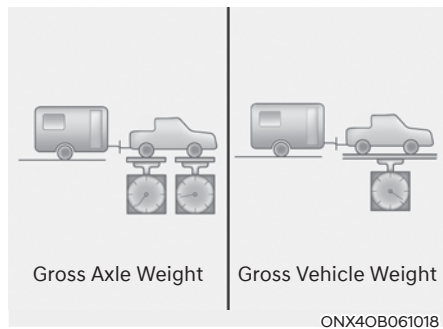

The tongue load is an important weight to measure because it affects the total Gross Vehicle Weight (GVW) of your vehicle. The trailer tongue should weigh a maximum of 10% of the total loaded trailer weight, within the limits of the maximum trailer tongue load permissible.

After you've loaded your trailer, weigh the trailer and then the tongue, separately, to see if the weights are proper. If they aren't, you may be able to correct them simply by moving some items around in the trailer.

### WARNING

Take the following precautions:

- Never load a trailer with more weight in the rear than in the front. The front should be loaded with approximately 60% of the total trailer load; the rear should be loaded with approximately 40% of the total trailer load.
- Never exceed the maximum weight limits of the trailer or trailer towing equipment. Improper loading can result in damage to your vehicle and/or personal injury. Check weights and loading at a commercial scale or highway patrol office equipped with scales.

### Information

With increasing altitude the engine performance decreases. From 3,280ft (1,000 m) above sea level and for every 3,280ft (1,000 m) thereafter 10% of vehicle/trailer weight (trailer weight + gross vehicle weight) must be deducted.



### **Towing a Trailer - Towing Load Limits**

#### **Towing a Trailer - Towing Load Limits**

The table below indicates the maximum trailer weight for your type of vehicle based on the number of vehicle occupants. Do not exceed the maximum allowable trailer weight as shown. The maximum trailer weight includes the weight of the trailer, any cargo in the trailer, and any other equipment or items attached to the trailer. Towing loads in excess of this can seriously affect vehicle handling and performance and can damage the engine and drivetrain.

Number of occupants	Smartstream G2.5 GDI		Smartstream G2.5 TGDI	
	2WD	AWD	2WD	AWD
2	3,500 lbs (1,587 kg)	3,500 lbs (1,587 kg)	3,500 lbs (1,587 kg)	5,000 lbs (2,268 kg)
4	3,200 lb. (1,451 kg)	3,200 lb. (1,451 kg)	3,200 lbs (1,451 kg)	4,700 lbs (2,131 kg)
5	3,050 lbs (1,383 kg)	3,050 lbs (1,383 kg)	3,050 lbs (1,383 kg)	4,550 lbs (2,063 kg)

Note: Weight limit recommendations are calculated based on the following assumptions:

- Occupants fill seats from the front of the vehicle to the back.
- Each occupant weighs 150 lbs (68 kg).
- Each occupant has 15 lbs (7 kg) of cargo in the cargo area.

**Any additional weight, cargo, or accessories reduce the maximum trailer weight and maximum tongue load.**

## Trailer Towing Equipment

### Hitches



#### **i** Information

**The mounting hole for hitches are located on both sides of the underbody behind the rear tires.**

It's important to have the correct hitch equipment. Crosswinds, large trucks going by, and rough roads are a few reasons why you'll need the right hitch. Here are some rules to follow:

- Do you have to make any holes in the body of your vehicle when you install a trailer hitch? If you do, then be sure to seal the holes later when you remove the hitch. If you don't seal them, carbon monoxide (CO) from your exhaust can get into your vehicle, as well as dirt and water.
- The bumpers on your vehicle are not intended for hitches. Do not attach rental hitches or other bumper-type hitches to them. Use only a frame-mounted hitch that does not attach to the bumper.

- Any part of the rear number plate or lighting devices of the vehicle must not be obscured by the mechanical coupling device.

If the rear number plate and/or lighting devices can be obscured partially by any part of the mechanical coupling device, mechanical coupling devices that can not be easily removed or repositioned without use of any tools, except an easily operated (for example, an effort not exceeding 20Nm) release key which is supplied by the manufacturer of the coupling device, are not permitted for use.

Please note that the mechanical coupling device that is fitted and not in use must always be removed or repositioned if the rear number plate and/or rear lighting devices are obscured by any part of the mechanical coupling device.

- A HYUNDAI trailer hitch accessory is available at an authorized HYUNDAI dealer.

#### **⚠ CAUTION**

**If a separate battery is installed on the trailer, the 12 volt battery on the vehicle may discharge.**

### **Safety chains**

You should always attach chains between your vehicle and your trailer.

Instructions about safety chains may be provided by the hitch manufacturer or trailer manufacturer. Follow the manufacturer's recommendation for attaching safety chains. Always leave just enough slack so you can turn with your trailer. And, never allow safety chains to drag on the ground.

### **Trailer brakes**

If your trailer is equipped with a braking system, make sure it conforms to your country's regulations and that it is properly installed and operating correctly.

If your trailer weighs more than the maximum trailer weight without trailer brakes loaded, then it needs its own brakes and they must be adequate. Be sure to read and follow the instructions for the trailer brakes so you'll be able to install, adjust and maintain them properly. Be sure not to modify your vehicle's brake system.



### **WARNING**

**Do not use a trailer with its own brakes unless you are absolutely certain that you have properly set up the brake system. This is not a task for amateurs. Use an experienced, competent trailer shop for this work.**

### **Driving with a Trailer**

Towing a trailer requires a certain amount of experience. Before setting out for the open road, you must get to know your trailer. Acquaint yourself with the feel of handling and braking with the added weight of the trailer. And always keep in mind that the vehicle you are driving is now longer and not nearly as responsive as your vehicle is by itself.

Before you start, check the trailer hitch and platform, safety chains, electrical connector(s), lights, tires and brakes.

During your trip, occasionally check to be sure that the load is secure, and that the lights and trailer brakes are still working.

### **Distance**

Stay at least twice as far behind the vehicle ahead as you would when driving your vehicle without a trailer. This can help you avoid situations that require heavy braking and sudden turns.

### **Passing**

You will need more passing distance up ahead when you're towing a trailer. And, because of the increased vehicle length, you'll need to go much farther beyond the passed vehicle before you can return to your lane.

### ***Backing up***

Hold the bottom of the steering wheel with one hand. Then, to move the trailer to the left, move your hand to the left. To move the trailer to the right, move your hand to the right. Always back up slowly and, if possible, have someone guide you.

### ***Making turns***

When you're turning with a trailer, make wider turns than normal. Do this so your trailer won't strike soft shoulders, curbs, road signs, trees, or other objects. Avoid jerky or sudden maneuvers. Signal well in advance.

### ***Turn signals***

When you tow a trailer, your vehicle has to have a different turn signal flasher and extra wiring. The green arrows on your instrument panel will flash whenever you signal a turn or lane change. Properly connected, the trailer lights will also flash to alert other drivers you're about to turn, change lanes, or stop.

When towing a trailer, the green arrows on your instrument panel will flash for turns even if the bulbs on the trailer are burned out. Thus, you may think drivers behind you are seeing your signals when, in fact, they are not. It's important to check occasionally to be sure the trailer bulbs are still working. You must also check the lights every time you disconnect and then reconnect the wires.



### **WARNING**

**Do not connect a trailer lighting system directly to your vehicle's lighting system. Use an approved trailer wiring harness. Failure to do so could result in damage to the vehicle electrical system and/or personal injury. Consult an authorized HYUNDAI dealer for assistance.**

### ***Driving on hills***

Reduce speed and shift to a lower gear before you start down a long or steep downgrade. If you don't shift down, you might have to use your brakes so much that they would get overheated and may not operate efficiently.

On a long uphill grade, shift down and reduce your speed to around 45 mph (70 km/h) to reduce the possibility of engine and transmission overheating.

If your trailer weighs more than the maximum trailer weight without trailer brakes and you have a automatic transmission, you should drive in D (Drive) when towing a trailer.

Operating your vehicle in D (Drive) when towing a trailer will minimize heat build-up and extend the life of your transmission.

**NOTICE**

To prevent engine and/or transmission overheating:

- When towing a trailer on steep grades (in excess of 6%) pay close attention to the engine coolant temperature gauge to ensure the engine does not overheat. If the needle of the coolant temperature gauge moves towards "H" (HOT), pull over and stop as soon as it is safe to do so, and allow the engine to idle until it cools down. You may proceed once the engine has cooled sufficiently.
- If you tow a trailer with the maximum gross vehicle weight and maximum trailer weight, it can cause the engine or transmission to overheat. When driving in such conditions, allow the engine to idle until it cools down. You may proceed once the engine or transmission has cooled sufficiently.
- When towing a trailer, your vehicle speed may be much slower than the general flow of traffic, especially when climbing an uphill grade. Use the right hand lane when towing a trailer on an uphill grade. Choose your vehicle speed according to the maximum posted speed limit for vehicles with trailers, the steepness of the grade, and your trailer weight.

**Parking on hills**

Generally, if you have a trailer attached to your vehicle, you should not park your vehicle on a hill.

However, if you ever have to park your trailer on a hill, here's how to do it:

1. Pull the vehicle into the parking space.  
Turn the steering wheel in the direction of the curb (right if headed down hill, left if headed up hill).
2. Shift the gear to P (Park).
3. Set the parking brake and shut off the vehicle.
4. Place wheel chocks under the trailer wheels on the down hill side of the wheels.
5. Start the vehicle, hold the brakes, shift to neutral, release the parking brake and slowly release the brakes until the trailer chocks absorb the load.
6. Reapply the brakes and parking brakes.
7. Shift the gear to P (Park) when the vehicle is parked on a uphill grade and in R (Reverse) on a downhill.
8. Shut off the vehicle and release the vehicle brakes but leave the parking brake set.

**WARNING**

To prevent serious or fatal injury:

- Do not get out of the vehicle without the parking brake firmly set. If you have left the engine running, the vehicle can move suddenly. You and others could be seriously or fatally injured.
- Do not apply the accelerator pedal to hold the vehicle on an uphill.

***Driving the vehicle after it has been parked on a hill***

1. With the gear in P (Park), apply your brakes and hold the brake pedal down while you:
  - Start your engine;
  - Shift into gear; and
  - Release the parking brake.
2. Slowly remove your foot from the brake pedal.
3. Drive slowly until the trailer is clear of the chocks.
4. Stop and have someone pick up and store the chocks.

**Maintenance when Towing a Trailer**

Your vehicle will need service more often when you regularly pull a trailer. Important items to pay particular attention to include engine oil, transmission fluid, axle lubricant and cooling system fluid. Brake condition is another important item to frequently check. If you're trailering, it's a good idea to review these items before you start your trip. Don't forget to also maintain your trailer and hitch. Follow the maintenance schedule that accompanied your trailer and check it periodically. Preferably, conduct the check at the start of each day's driving. Most importantly, all hitch nuts and bolts should be tight.

**NOTICE**

**To prevent vehicle damage:**

- **Due to higher load during trailer usage, overheating might occur on hot days or during uphill driving. If the coolant gauge indicates over-heating, switch off the air conditioner and stop the vehicle in a safe area to cool down the engine.**
- **Do not switch off the engine while the coolant gauge indicates over-heating.**  
**(Keep the engine idle to cool down the engine)**
- **When towing check transmission fluid more frequently.**
- **If your vehicle is not equipped with an air conditioner, you should install a condenser fan to improve engine performance when towing a trailer.**

## VEHICLE LOAD LIMIT

Two labels on your driver's door sill show how much weight your vehicle was designed to carry: the Tire and Loading Information Label and the Certification Label.

Before loading your vehicle, familiarize yourself with the following terms for determining your vehicle's weight ratings, from the vehicle's specifications and the Certification Label:

### Base Curb Weight

This is the weight of the vehicle including a full tank of fuel and all standard equipment. It does not include passengers, cargo, or optional equipment.

### Vehicle Curb Weight

This is the weight of your new vehicle when you picked it up from your dealer plus any aftermarket equipment.

### Cargo Weight

This figure includes all weight added to the Base Curb Weight, including cargo and optional equipment.

### GAW (Gross Axle Weight)

This is the total weight placed on each axle (front and rear) - including vehicle curb weight and all payload.

### GAWR (Gross Axle Weight Rating)

This is the maximum allowable weight that can be carried by a single axle (front or rear). These numbers are shown on the Certification Label. The total load on each axle must never exceed its GAWR.

### GVW (Gross Vehicle Weight)

This is the Base Curb Weight plus actual Cargo Weight plus passengers.

### GVWR (Gross Vehicle Weight Rating)

This is the maximum allowable weight of the fully loaded vehicle (including all options, equipment, passengers and cargo). The GVWR is shown on the Certification Label located on the driver's door sill.

## The Loading Information Label

### 18 inch

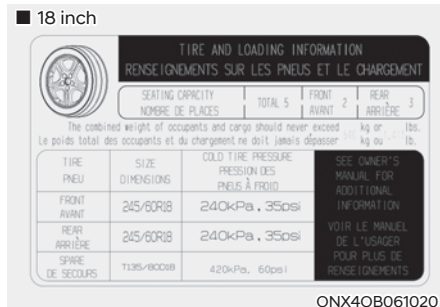

### 20 inch

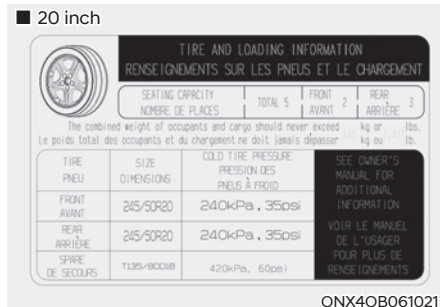

The label located on the driver's door sill gives the original tire size, cold tire pressures recommended for your vehicle, the number of people that can be in your vehicle and vehicle capacity weight.

### Vehicle capacity weight

5 persons : 1,411 lbs (640 kg)

Vehicle capacity weight is the maximum combined weight of occupants and cargo. If your vehicle is equipped with a trailer, the combined weight includes the tongue load.

### Seating capacity

Total : 5 persons (Front seat : 2 persons, Rear seat : 3 persons)

Seating capacity is the maximum number of occupants including a driver, your vehicle may carry. However, the seating capacity may be reduced based upon the weight of all of the occupants, and the weight of the cargo being carried or towed. Do not overload the vehicle as there is a limit to the total weight, or load limit including occupants and cargo, the vehicle can carry.

### Towing capacity

With brake system :

2.5 GDI/ 2.5 T-GDI (2WD) :  
3,500 lbs (1,588 kg)

2.5 T-GDI (AWD) : 5,000 lbs (2,268 kg)

Towing capacity is the maximum trailer weight including its cargo weight, your vehicle can tow.

### Cargo capacity

The cargo capacity of your vehicle will increase or decrease depending on the weight and the number of occupants and the tongue load, if your vehicle is equipped with a trailer.



### **Steps for determining correct load limit**

1. Locate the statement "The combined weight of occupants and cargo should never exceed XXX kg or XXX lbs." on your vehicle's placard.
2. Determine the combined weight of the driver and passengers that will be riding in your vehicle.
3. Subtract the combined weight of the driver and passengers from XXX kg or XXX lbs.
4. The resulting figure equals the available amount of cargo and luggage load capacity. For example, if the "XXX" amount equals 1400 lbs. and there will be five 150 lb passengers in your vehicle, the amount of available cargo and luggage load capacity is 650 lbs. (1400 - 750 (5 x 150) = 650 lbs.)
5. Determine the combined weight of luggage and cargo being loaded on the vehicle. That weight may not safely exceed the available cargo and luggage load capacity calculated in Step 4.
6. If your vehicle will be towing a trailer, load from your trailer will be transferred to your vehicle. Consult this manual to determine how this reduces the available cargo and luggage load capacity of your vehicle.



### **WARNING**

**Do not overload the vehicle as there is a limit to the total weight, or load limit, including occupants and cargo, the vehicle can carry. Overloading can shorten the life of the vehicle. If the GVWR or the GAWR is exceeded, parts on the vehicle can break, and it can change the handling of your vehicle. These could cause you to lose control and result in an accident.**

### **Maximum Load Limit**

Carrying too much cargo or improperly storing it can affect your vehicle's handling, stability, stopping distance, and tires, and make it unsafe.

#### ■ Maximum Load For Your Vehicle







The maximum load for your vehicle type is:

- 2WD : 1,411 lbs (640 kg)
- AWD : 1,411 lbs (640 kg)



### **WARNING**

**The cargo should never exceed 661 lbs. or 300 kg.**

<p><b>Example 1</b></p>	 <p>Vehicle Capacity</p> <p>Maximum Load (1400 lbs.) (635 kg)</p>	<p>≥</p>	 <p>Passenger Weight (150 lbs. × 5 = 750 lbs.) (68 kg × 5 = 340 kg)</p>	<p>+</p>	 <p>Cargo Weight (650 lbs.) (295 kg)</p>
<p><b>Example 2</b></p>	 <p>Vehicle Capacity</p> <p>Maximum Load (1400 lbs.) (635 kg)</p>	<p>≥</p>	 <p>Passenger Weight (172 lbs. × 5 = 860 lbs.) (78 kg × 5 = 390 kg)</p>	<p>+</p>	 <p>Cargo Weight (540 lbs.) (245 kg)</p>

### Certification label



The certification label is located on the driver's door sill at the center pillar and shows the maximum allowable weight of the fully loaded vehicle. This is called the GVWR (Gross Vehicle Weight Rating). The GVWR includes the weight of the vehicle, all occupants, fuel and cargo.

This label also tells you the maximum weight that can be supported by the front and rear axles, called Gross Axle Weight Rating (GAWR).

The total weight of the vehicle, including all occupants, accessories, cargo, and trailer tongue load must not exceed the Gross Vehicle Weight Rating (GVWR) or the Gross Axle Weight Rating (GAWR). To find out the actual loads on your front and rear axles, you need to go to a weigh station and weigh your vehicle. Be sure to spread out your load equally on both sides of the centerline.

### WARNING

#### Overloading

- Never exceed the GVWR for your vehicle, the GAWR for either the front or rear axle and vehicle capacity weight. Exceeding these ratings can affect your vehicle's handling and braking ability, and cause an accident.
- Do not overload your vehicle. Overloading your vehicle can cause heat buildup in your vehicle's tires and possible tire failure, increased stopping distances and poor vehicle handling—all of which may result in a crash.

### **NOTICE**

Overloading your vehicle may cause damage. Repairs would not be covered by your warranty. Do not overload your vehicle.

### WARNING

If you carry items inside your vehicle (for example, suitcases, tools, packages, or anything else), they are moving as fast as the vehicle. If you have to stop or turn quickly, or if there is a crash, the items will keep going and can cause an injury if they strike the driver or a passenger.

- Put items in the cargo area of your vehicle. Try to spread the weight evenly.
- Do not stack items, like suitcases, inside the vehicle above the tops of the seats.
- Do not leave an unsecured child restraint in your vehicle.
- When you carry something inside the vehicle, secure it.



# 7. Driver Assistance System

---

Driving Safety	
Forward Collision-Avoidance Assist (FCA) (Front view camera only) .....	7-2
Forward Collision-Avoidance Assist (FCA) (Sensor fusion) .....	7-14
Lane Keeping Assist (LKA) .....	7-30
Blind-Spot Collision-Avoidance Assist (BCA) .....	7-36
Safe Exit Warning (SEW) .....	7-50
Manual Speed Limit Assist (MSLA) .....	7-56
Intelligent speed limit assist (ISLA) .....	7-59
Driver Attention Warning (DAW) .....	7-64
Blind-Spot View Monitor (BVM).....	7-70
Driving Convenience	
Cruise Control (CC) .....	7-72
Smart Cruise Control (SCC) .....	7-76
Navigation-based Smart Cruise Control (NSCC).....	7-93
Lane Following Assist (LFA).....	7-100
Highway Driving Assist (HDA) .....	7-104
Parking Safety	
Rear View Monitor (RVM) .....	7-111
Surround View Monitor (SVM) .....	7-115
Rear Cross-Traffic Collision-Avoidance Assist (RCCA) .....	7-120
Declaration of Conformity .....	7-131

## FORWARD COLLISION-AVOIDANCE ASSIST (FCA) (FRONT VIEW CAMERA ONLY) (IF EQUIPPED)

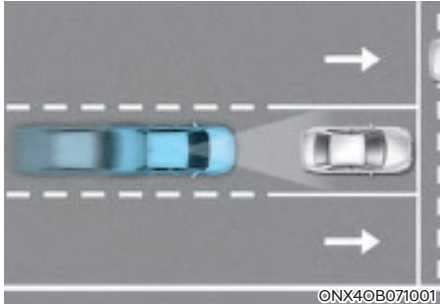

Forward Collision Avoidance Assist is designed to help detect and monitor a vehicle on the roadway ahead or help detect if a pedestrian or cyclist is in the roadway. Forward Collision Avoidance Assist will warn the driver with an audible warning and a message in the LCD cluster if it determines that a collision is imminent. In certain cases, emergency braking may be applied.

### ***Detecting sensor***



[1] : Front view camera

Refer to the picture above for the detailed location of the detecting sensor.



### **CAUTION**

Take the following precautions to maintain optimal performance of the detecting sensor:

- **NEVER** disassemble the detecting sensor or sensor assembly, or cause any damage to it.
- If the detecting sensor has been replaced or repaired, have your vehicle inspected by an authorized HYUNDAI dealer.
- **NEVER** install any accessories or stickers on the front windshield, or tint the front windshield.
- **Pay extreme caution** to keep the front view camera dry.
- **NEVER** place any reflective objects (for example, white paper, mirror) over the dashboard.

## Forward Collision-Avoidance Assist Settings

### Setting features

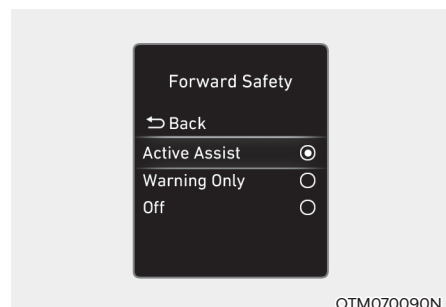

#### Forward Safety

With the engine on, select or deselect 'Driver Assistance → Forward Safety' from the Settings menu to set whether to use each function.

- If 'Active Assist' is selected, Forward Collision-Avoidance Assist warns the driver with a warning message and an audible warning depending on the collision risk levels. Braking assist is applied depending on the collision risk levels.
- If 'Warning Only' is selected, Forward Collision-Avoidance Assist warns the driver with a warning message and an audible warning depending on the collision risk levels. Braking is not assisted. The driver must apply the brake pedal if necessary.
- If 'Off' is selected, Forward Collision-Avoidance Assist turns off. The  warning light illuminates on the cluster.

The driver can monitor Forward Collision-Avoidance Assist On/Off status from the Settings menu. If the  warning light remains on when Forward Collision-Avoidance Assist is on, have the vehicle inspected by an authorized HYUNDAI dealer.

#### WARNING

When the engine is restarted, Forward Collision-Avoidance Assist will always turn on. However, if 'Off' is selected after the engine is restarted, note that Forward Collision Avoidance will not be active. The driver must take extra precaution while driving and always be aware of the vehicle surroundings.

#### CAUTION

If 'Warning Only' is selected, braking is not assisted.

#### Information

Forward Collision-Avoidance Assist will turn off when ESC is turned off by pressing and holding the ESC OFF button. The  warning light illuminates on the cluster.

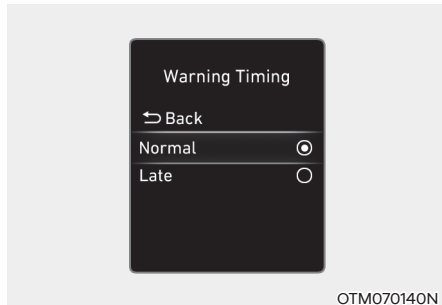

### Warning Timing

With the engine on, select 'Driver Assistance → Warning Timing' from the Settings menu to change the initial warning activation time for Forward Collision-Avoidance Assist.

When the vehicle is first delivered, the Warning Timing is set to 'Normal'. If you change the Warning Timing, the Warning Timing of other Driver Assistance systems may change.

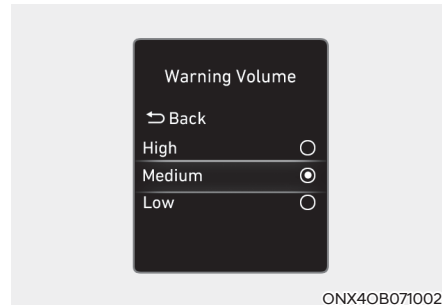

### Warning Volume

With the engine on, select 'Driver Assistance → Warning Volume' from the Settings menu to change the Warning Volume to 'High', 'Medium' or 'Low' for Forward Collision-Avoidance Assist.

If you change the Warning Volume, the Warning Volume of other Driver Assistance systems may change.



### CAUTION

- The setting of the Warning Timing and Warning Volume applies to all functions of Forward Collision-Avoidance Assist.
- Even though, 'Normal' is selected for Warning Timing if the front vehicle suddenly stops, the warning may seem late.
- Select 'Late' for Warning Timing when traffic is light and when driving speed is slow.



### Information

If the engine is restarted, Warning Timing and Warning Volume will maintain the last setting.



## Forward Collision-Avoidance Assist Operation

### Warning and control

The basic function of Forward Collision Avoidance Assist is to help warn the driver and, if necessary, control the vehicle to help mitigate a collision. The following warning messages may be displayed depending on the collision risk level.

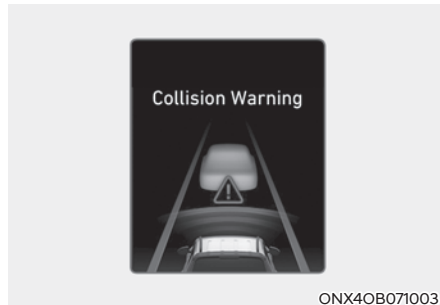

ONX4OB071003

### Collision Warning

- To warn the driver of a collision, the 'Collision Warning' warning message appears on the cluster and an audible warning sounds.
- If a vehicle is detected in front, the function operates when your vehicle speed is between approximately 6-112 mph (10-180 km/h).
- If a pedestrian or cyclist is detected in front, the function operates when your vehicle speed is between approximately 6-37 mph (10-60 km/h).
- If 'Active Assist' is selected, braking may be assisted.

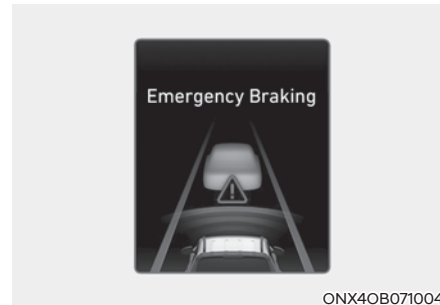

ONX4OB071004

### Emergency Braking

- To warn the driver that emergency braking is assisted, the 'Emergency Braking' warning message appears on the cluster and an audible warning sounds.
- If a vehicle is detected in front, the function operates when your vehicle speed is between approximately 6-37 mph (10-60 km/h).
- If a pedestrian or cyclist is detected in front, the function operates when your vehicle speed is between approximately 6-37 mph (10-60 km/h).
- In emergency braking situation, braking is assisted with strong braking power by the function to help prevent collision with the vehicle, pedestrian or cyclist ahead.



### Stopping vehicle and ending brake control

- When the vehicle is stopped due to emergency braking, the 'Drive carefully' warning message appears on the cluster.  
For your safety, the driver should depress the brake pedal immediately and check the surroundings.
- Brake control ends after the vehicle is stopped by emergency braking for approximately 2 seconds.



### WARNING

Take the following precautions when using Forward Collision-Avoidance Assist:

- For your safety, change the Settings after parking the vehicle at a safe location.
- With 'Active Assist' or 'Warning Only' selected, when ESC is turned off by pressing and holding the ESC OFF button, Forward Collision-Avoidance Assist will turn off automatically. In this case, Forward Collision-Avoidance Assist cannot be set from the Settings menu and the warning light illuminates on the cluster which is normal. If ESC is turned on by pressing the ESC OFF button, Forward Collision-Avoidance Assist will maintain the last setting.
- Forward Collision-Avoidance Assist does not operate in all situations or cannot avoid all collisions.
- The driver should hold the responsibility to control the vehicle. Do not solely depend on Forward Collision-Avoidance Assist. Rather, maintain a safe braking distance, and, if necessary, depress the brake pedal to reduce driving speed or to stop the vehicle.
- Never deliberately operate Forward Collision-Avoidance Assist on people, animal, objects, etc. It may cause serious injury or death.
- Forward Collision-Avoidance Assist may not operate if the driver depresses the brake pedal to avoid collision.
- Depending on the road and driving conditions, Forward Collision-Avoidance Assist may warn the driver late or may not warn the driver.
- During Forward Collision-Avoidance Assist operation, the vehicle may stop suddenly injuring passengers and shifting loose objects. Always have the seat belt on and keep loose objects secured.
- If any other system's warning message is displayed or audible warning is generated, Forward Collision-Avoidance Assist warning message may not be displayed and audible warning may not be generated.
- You may not hear the warning sound of Forward Collision-Avoidance Assist if the surrounding is noisy.
- Forward Collision-Avoidance Assist may turn off or may not operate properly or may operate unnecessarily depending on the road conditions and the surroundings.

### WARNING

- Even if there is a problem with Forward Collision-Avoidance Assist, the vehicle's basic braking performance will operate properly.
- During emergency braking, braking control by Forward Collision-Avoidance Assist will automatically cancel when the driver excessively depresses the accelerator pedal or sharply steers the vehicle.

### CAUTION

Depending on the condition of the vehicle, pedestrian and cyclist in front and the surroundings, the speed range to operate Forward Collision-Avoidance Assist may reduce. Forward Collision-Avoidance Assist may only warn the driver, or it may not operate.



### Information

- In a situation where collision is imminent, braking may be assisted by Forward Collision-Avoidance Assist when braking is insufficient by the driver.
- The images and colors in the cluster may differ depending on the cluster type or theme selected from the cluster.

## Forward Collision-Avoidance Assist Malfunction and Limitations

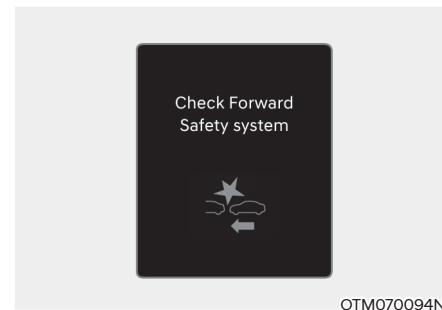
### *Forward Collision-Avoidance Assist malfunction*



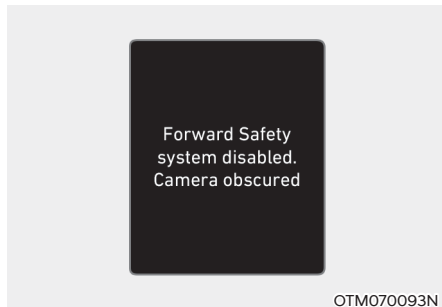

When Forward Collision-Avoidance Assist is not working properly, the 'Check Forward Safety system' warning message appears, and the  and  warning lights illuminate on the cluster. If this occurs, have the vehicle inspected by an authorized HYUNDAI dealer.

### **Forward Collision-Avoidance Assist disabled**



When the front windshield where the front view camera is located or the sensor is covered with foreign material, such as snow or rain, it can reduce the detecting performance and temporarily limit or disable Forward Collision-Avoidance Assist.

If this occurs the 'Forward Safety system disabled. Camera obscured' warning message, and the  and  warning lights illuminate on the cluster.

Forward Collision-Avoidance Assist will operate properly when such snow, rain or foreign material is removed.

If Forward Collision-Avoidance Assist does not operate properly after obstruction (snow, rain, or foreign material) is removed, have the vehicle inspected by an authorized HYUNDAI dealer.

### **WARNING**

- **Even though the warning message or warning light does not appear on the cluster, Forward Collision-Avoidance Assist may not properly operate.**
- **Forward Collision-Avoidance Assist may not properly operate in an area (for example, open terrain), where any objects are not detected after turning ON the engine.**

### **Limitations of Forward Collision-Avoidance Assist**

Forward Collision-Avoidance Assist may not operate properly, or it may operate unexpectedly under the following circumstances:

- The detecting sensor or the surroundings are contaminated or damaged
- The temperature around the front view camera is high or low due to surrounding environment
- The camera lens is contaminated due to tinted, filmed or coated windshield, damaged glass, or sticky foreign material (sticker, bug, etc.) on the glass
- Moisture is not removed or frozen on the windshield
- Washer fluid is continuously sprayed, or the wiper is on
- Driving in heavy rain or snow, or thick fog
- The field of view of the front view camera is obstructed by sun glare
- Street light or light from an oncoming traffic is reflected on the wet road surface, such as a puddle on the road
- An object is placed on the dashboard
- Your vehicle is being towed
- The surrounding is very bright
- The surrounding is very dark, such as in a tunnel, etc.
- The brightness changes suddenly, for example when entering or exiting a tunnel
- The brightness outside is low, and the headlamps are not on or are not bright

- Driving through steam, smoke or shadow
- Only part of the vehicle, pedestrian or cyclist is detected
- The vehicle in front is a bus, heavy truck, truck with an unusually shaped cargo, trailer, etc.
- The vehicle in front has no tail lights, tail lights are located unusually, etc.
- The brightness outside is low, and the tail lamps are not on or are not bright
- The rear of the front vehicle is small or the vehicle does not look normal, such as when the vehicle is tilted, overturned, or the side of the vehicle is visible, etc.
- The front vehicle's ground clearance is low or high
- A vehicle, pedestrian or cyclist suddenly cuts in front
- The vehicle in front is detected late
- The vehicle in front is suddenly blocked by an obstacle
- The vehicle in front suddenly changes lane or suddenly reduces speed
- The vehicle in front is bent out of shape
- The front vehicle's speed is fast or slow
- The vehicle in front steers in the opposite direction of your vehicle to avoid a collision
- With a vehicle in front, your vehicle changes lane at low speed
- The vehicle in front is covered with snow
- You are departing or returning to the lane
- Unstable driving
- You are on a roundabout and the vehicle in front is not detected
- You are continuously driving in a circle
- The vehicle in front has an unusual shape
- The vehicle in front is driving uphill or downhill
- The pedestrian or cyclist is not fully detected, for example, if the pedestrian is leaning over or is not fully walking upright
- The pedestrian or cyclist is wearing clothing or equipment that makes it difficult to detect

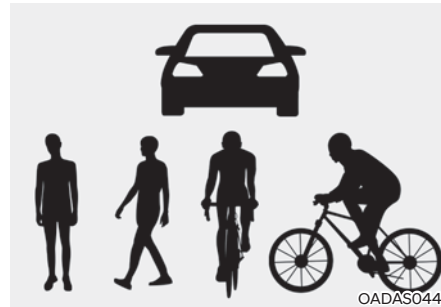

The illustration above shows the image the front view camera is capable of detecting as a vehicle, pedestrian and cyclist.

- The pedestrian or cyclist in front is moving very quickly
- The pedestrian or cyclist in front is short or is posing a low posture
- The pedestrian or cyclist in front has impaired mobility
- The pedestrian or cyclist in front is moving intersected with the driving direction

- There is a group of pedestrians, cyclists or a large crowd in front
- The pedestrian or cyclist is wearing clothing that easily blends into the background, making it difficult to detect
- The pedestrian or cyclist is difficult to distinguish from the similarly shaped structure in the surroundings
- You are driving by a pedestrian, cyclist, traffic sign, structure, etc., near the intersection
- Driving in a parking lot
- Driving through a tollgate, construction area, unpaved road, partial paved road, uneven road, speed bumps, etc.
- Driving on an incline road, curved road, etc.
- Driving through a roadside with trees or streetlights
- The adverse road conditions cause excessive vehicle vibrations while driving
- Your vehicle height is low or high due to heavy loads, abnormal tire pressure, etc.
- Driving through a narrow road where trees or grass are overgrown
- There is interference by electromagnetic waves, such as driving in an area with strong radio waves or electrical noise

### WARNING

- Driving on a curved road

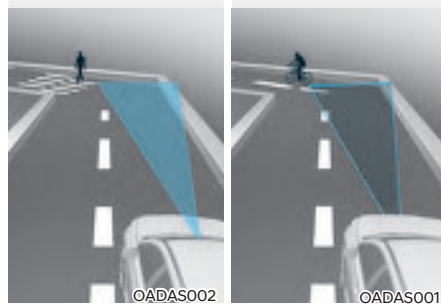
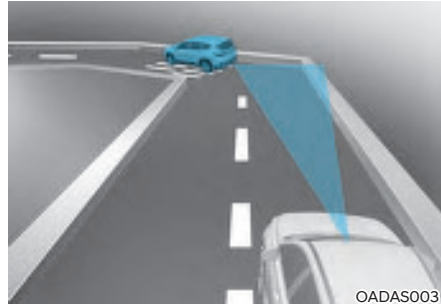

**Forward Collision-Avoidance Assist may not detect other vehicles, pedestrians or cyclists in front of you on curved roads adversely affecting the performance of the sensors. This may result in no warning or braking assist when necessary.**

**When driving on a curved road, you must maintain a safe braking distance, and if necessary, steer the vehicle and depress the brake pedal to reduce your driving speed in order to maintain a safe distance.**

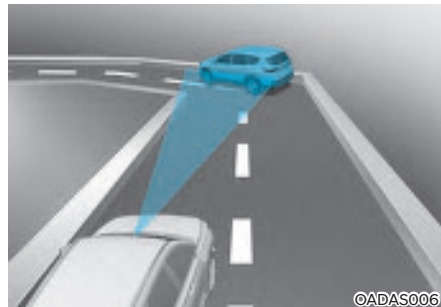

©ADAS006

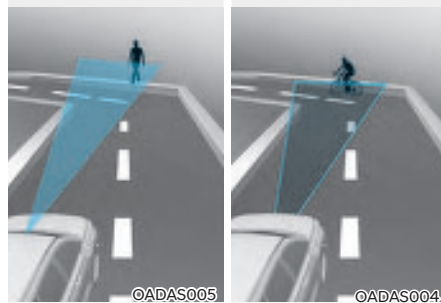

©ADAS005

©ADAS004

**Forward Collision-Avoidance Assist may detect a vehicle, pedestrian or cyclist in the next lane or outside the lane when driving on a curved road.**

**If this occurs, Forward Collision-Avoidance Assist may unnecessarily warn the driver and control the brake. Always check the traffic conditions around the vehicle.**

- **Driving on an inclined road**



©ADAS009

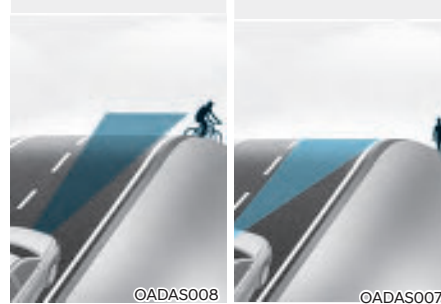

©ADAS008

©ADAS007

**Forward Collision-Avoidance Assist may not detect other vehicles, pedestrians or cyclists in front of you while driving uphill or downhill adversely affecting the performance of the sensors.**

**This may result in unnecessary warning or braking assist, or no warning or braking assist when necessary.**

**Also, vehicle speed may rapidly decrease when a vehicle, pedestrian or cyclist ahead is suddenly detected.**

**Always have your eyes on the road while driving uphill or downhill and if necessary, steer the vehicle and depress the brake pedal to reduce your driving speed in order to maintain a safe distance.**

• Changing lanes

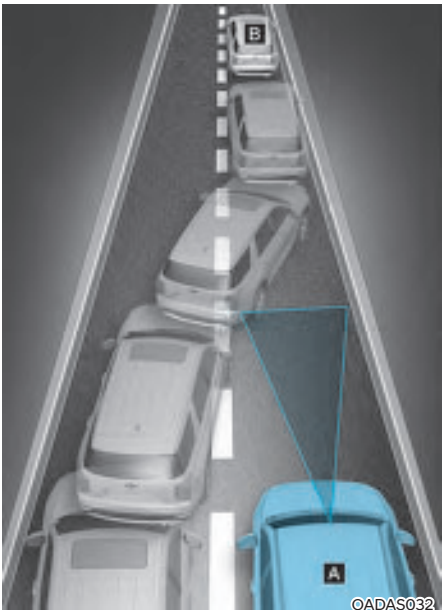

[A] : Your vehicle,  
[B] : Lane changing vehicle

**When a vehicle moves into your lane from an adjacent lane, it cannot be detected by the sensor until it is in the sensor's detection range. Forward Collision-Avoidance Assist may not immediately detect the vehicle when the vehicle changes lanes abruptly. In this case, you must maintain a safe braking distance, and if necessary, steer the vehicle and depress the brake pedal to reduce your driving speed in order to maintain a safe distance.**

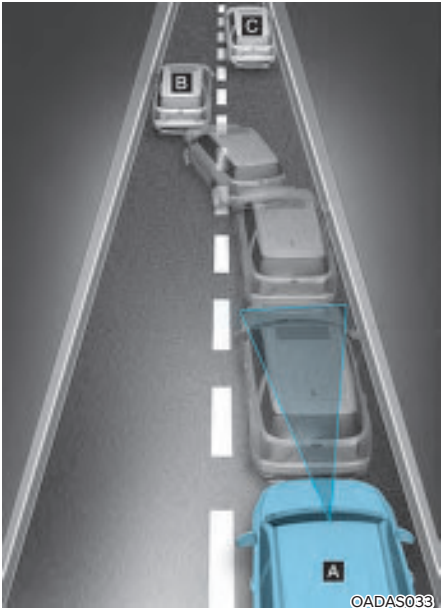

[A] : Your vehicle,  
[B] : Lane changing vehicle,  
[C] : Same lane vehicle

**When a vehicle in front of you merges out of the lane, Forward Collision-Avoidance Assist may not immediately detect the vehicle that is now in front of you.**

**In this case, you must maintain a safe braking distance, and if necessary, steer the vehicle and depress the brake pedal to reduce your driving speed in order to maintain a safe distance.**



- Detecting vehicle

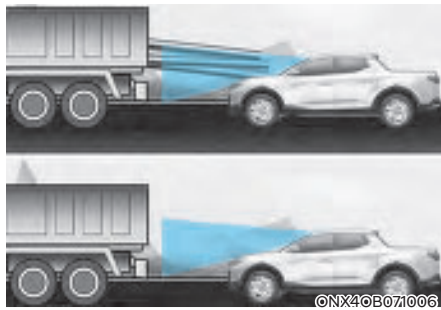

If the vehicle in front of you has cargo that extends rearward from the cab, or when the vehicle in front of you has higher ground clearance, additional special attention is required. Forward Collision-Avoidance Assist may not be able to detect the cargo extending from the vehicle. In these instances, you must maintain a safe braking distance from the rearmost object, and if necessary, steer the vehicle and depress the brake pedal to reduce your driving speed in order to maintain distance.

 **WARNING**

- When you are towing a trailer or another vehicle, we recommend that Forward Collision-Avoidance Assist is turned off due to safety reasons.
- Forward Collision-Avoidance Assist may operate if objects that are similar in shape or characteristics to vehicles, pedestrians and cyclists are detected.
- Forward Collision-Avoidance Assist does not operate on bicycles, motorcycles, or smaller wheeled objects, such as luggage bags, shopping carts, or strollers.
- Forward Collision-Avoidance Assist may not operate properly if interfered by strong electromagnetic waves.
- Forward Collision-Avoidance Assist may not operate for 15 seconds after the vehicle is started, or the front view camera is initialized.

## FORWARD COLLISION-AVOIDANCE ASSIST (FCA) (SENSOR FUSION) (IF EQUIPPED)

### Basic function

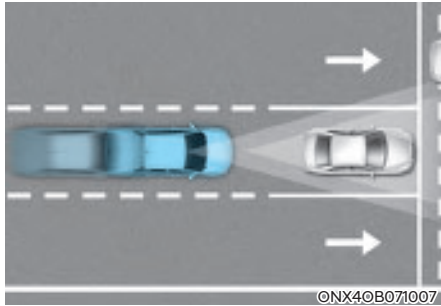

Forward Collision Avoidance Assist is designed to help detect and monitor a vehicle on the roadway ahead or help detect if a pedestrian or cyclist is in the roadway. Forward Collision Avoidance Assist will warn the driver with an audible warning and a message in the LCD cluster if it determines that a collision is imminent. In certain cases, emergency braking may be applied.

### Junction Turning function

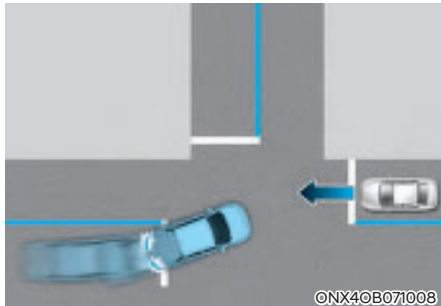

The Junction Turning function can help avoid a collision with an oncoming vehicle when attempting to make a left hand turn at an intersection. If the function detects that a collision is imminent, a warning message occurs and in certain cases, emergency braking may be applied.

### Detecting sensor



[1] : Front view camera,  
[2] : Front radar

Refer to the picture above for the detailed location of the detecting sensors.

**CAUTION**

Take the following precautions to maintain optimal performance of the detecting sensor:

- Never disassemble the detecting sensor or sensor assembly, or cause any damage to it.
- If the detecting sensors have been replaced or repaired, have the vehicle inspected by an authorized HYUNDAI dealer.
- Never install any accessories or stickers on the front windshield, or tint the front windshield.
- Pay extreme caution to keep the front view camera dry.
- Never place any reflective objects (for example, white paper, mirror) over the dashboard.
- Do not apply license plate frame or objects, such as a bumper sticker, film or a bumper guard, near the front radar cover.
- Always keep the front radar and cover clean and free of dirt and debris.

Use only a soft cloth to wash the vehicle. Do not spray pressurized water directly on the sensor or sensor cover.

- If the radar or around the radar has been damaged or impacted in any way, Forward Collision-Avoidance Assist may not properly operate even though a warning message does not appear on the cluster. Have the vehicle inspected by an authorized HYUNDAI dealer.
- Use only genuine parts to repair or replace a damaged front radar cover. Do not apply paint to the front radar cover.

## Forward Collision-Avoidance Assist Settings

### Setting features



#### Forward Safety

With the engine on, select 'Driver Assistance → Forward Safety' from the Settings menu to set whether to use each function.

- If 'Active Assist' is selected, Forward Collision-Avoidance Assist warns the driver with a warning message and an audible warning depending on the collision risk levels. Braking assist is applied depending on the collision risk levels.
- If 'Warning Only' is selected, Forward Collision-Avoidance Assist warns the driver with a warning message and an audible warning depending on the collision risk levels. Braking is not assisted. The driver must apply the brake pedal if necessary.
- If 'Off' is selected, Forward Collision-Avoidance Assist turns off. The  warning light illuminates on the cluster.

The driver can monitor Forward Collision-Avoidance Assist On/Off status from the Settings menu. If the  warning light remains on when Forward Collision-Avoidance Assist is on, have the vehicle inspected by an authorized HYUNDAI dealer.

#### WARNING

**When the engine is restarted, Forward Collision-Avoidance Assist will always turn on. However, if 'Off' is selected after the engine is restarted, note that Forward Collision Avoidance will not be active. The driver must take extra precaution while driving and always be aware of the vehicle surroundings.**

#### CAUTION

- If 'Warning Only' is selected, braking is not assisted.
- The settings for Forward Safety include 'Basic function' and 'Junction Turning' (if equipped).

#### Information

**Forward Collision-Avoidance Assist will turn off when ESC is turned off by pressing and holding the ESC OFF button. The  warning light illuminates on the cluster.**

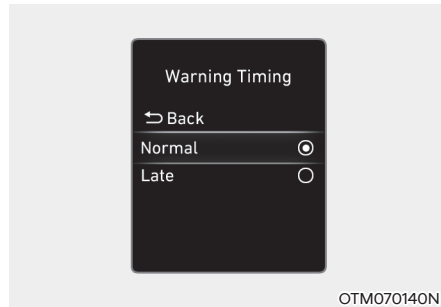

### Warning Timing

With the engine on, select 'Driver Assistance → Warning Timing' from the Settings menu to change the initial warning activation time for Forward Collision-Avoidance Assist.

When the vehicle is first delivered, Warning Timing is set to 'Normal'. If you change the Warning Timing, the Warning Timing of other Driver Assistance systems may change.

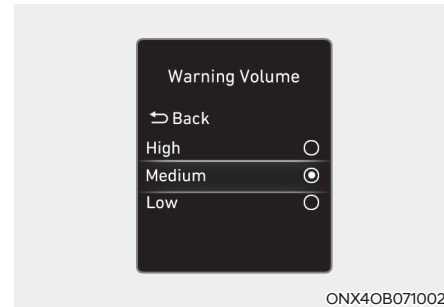

### Warning Volume

With the engine on, select 'Driver Assistance → Warning Volume' from the Settings menu to change the Warning Volume to 'High', 'Medium' or 'Low' for Forward Collision-Avoidance Assist.

If you change the Warning Volume, the Warning Volume of other Driver Assistance systems may change.



### CAUTION

- The setting of the Warning Timing and Warning Volume applies to all functions of Forward Collision-Avoidance Assist.
- Even though 'Normal' is selected for Warning Timing, if the front vehicle suddenly stops, the warning may seem late.
- Select 'Late' for Warning Timing when traffic is light and when driving speed is slow.



### Information

If the engine is restarted, Warning Timing and Warning Volume will maintain the last setting.

## Forward Collision-Avoidance Assist Operation

### Basic function

#### Warning and control

The basic function of Forward Collision Avoidance Assist is to help warn the driver and, if necessary, control the vehicle to help mitigate a collision. The following warning messages may be displayed depending on the collision risk level.



#### Collision Warning

- To warn the driver of a collision, the 'Collision Warning' warning message appears on the cluster and an audible warning sounds.
- If a vehicle is detected in front, the function will operate when your vehicle speed is between approximately 6-112 mph (10-180 km/h).
- If a pedestrian or cyclist is detected in front, the function operates when your vehicle speed is between approximately 6-53 mph (10-85 km/h).
- If 'Active Assist' is selected, braking may be assisted.

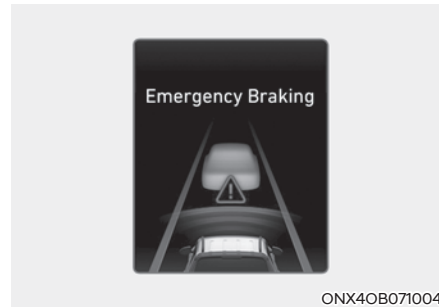

#### Emergency Braking

- To warn the driver that emergency braking is assisted, the 'Emergency Braking' warning message appears on the cluster and an audible warning sounds.
- If a vehicle is detected in front, the function operates when your vehicle speed is between approximately 6-47 mph (10-75 km/h).
- If a pedestrian or cyclist is detected in front, the function operates when your vehicle speed is between approximately 6-40 mph (10-65 km/h).
- In emergency braking situation, braking is assisted with strong braking power by the function to help prevent collision with the vehicle, pedestrian or cyclist ahead.



ONX4OB071005

#### Stopping vehicle and ending brake control

- When the vehicle is stopped due to emergency braking, the 'Drive carefully' warning message appears on the cluster.  
For your safety, the driver should depress the brake pedal immediately and check the surroundings.
- Brake control ends after the vehicle is stopped by emergency braking for approximately 2 seconds.

### Junction Turning function

#### Warning and control

Junction Turning function will warn and help control the vehicle depending on the collision risk level: 'Collision Warning', 'Emergency Braking' and 'Stopping vehicle and ending brake control'



ONX4OB071010

#### Collision Warning

- To warn the driver of a collision, the 'Collision Warning' warning message appears on the cluster and an audible warning sounds.
- The function operates when your vehicle speed is between approximately 6-19 mph (10-30 km/h) and the oncoming vehicle speed is between approximately 19-44 mph (30-70 km/h).
- If 'Active Assist' is selected, braking may be assisted.



**Emergency Braking**

- To warn the driver that emergency braking is assisted, the 'Emergency Braking' warning message appears on the cluster and an audible warning sounds.
- The function operates when your vehicle speed is between approximately 6-19 mph (10-30 km/h) and the oncoming vehicle speed is between approximately 19-44 mph (30-70 km/h).
- In emergency braking situation, braking is assisted with strong braking power by the function to help prevent collision with the oncoming vehicle.



**Stopping vehicle and ending brake control**

- When the vehicle is stopped due to emergency braking, the 'Drive carefully' warning message appears on the cluster.  
For your safety, the driver should depress the brake pedal immediately and check the surroundings.
- Brake control ends after the vehicle is stopped by emergency braking for approximately 2 seconds.



**WARNING**

Take the following precautions when using Forward Collision-Avoidance Assist:

- For your safety, change the Settings after parking the vehicle at a safe location.
- With 'Active Assist' or 'Warning Only' selected, when ESC is turned off by pressing and holding the ESC OFF button, Forward Collision-Avoidance Assist will turn off automatically. In this case, Forward Collision-Avoidance Assist cannot be set from the Settings menu and the warning light illuminates on the cluster which is normal. If ESC is turned on by pressing the ESC OFF button, Forward Collision-Avoidance Assist will maintain the last setting.
- Forward Collision-Avoidance Assist does not operate in all situations or cannot avoid all collisions.
- The driver should hold the responsibility to control the vehicle. Do not solely depend on Forward Collision-Avoidance Assist. Rather, maintain a safe braking distance, and if necessary, depress the brake pedal to reduce driving speed or to stop the vehicle.
- Never deliberately operate Forward Collision-Avoidance Assist on people, animal, objects, etc. It may cause serious injury or death.
- Forward Collision-Avoidance Assist may not operate if the driver depresses the brake pedal to avoid collision.
- Depending on the road and driving conditions, Forward Collision-Avoidance Assist may warn the driver late or may not warn the driver.
- During Forward Collision-Avoidance Assist operation, the vehicle may stop suddenly injuring passengers and shifting loose objects. Always have the seat belt on and keep loose objects secured.
- If any other system's warning message is displayed or audible warning is generated, Forward Collision-Avoidance Assist warning message may not be displayed and audible warning may not be generated.
- You may not hear the warning sound of Forward Collision-Avoidance Assist if the surrounding is noisy.
- Forward Collision-Avoidance Assist may turn off or may not operate properly or may operate unnecessarily depending on the road conditions and the surroundings.

**WARNING**

- Even if there is a problem with Forward Collision-Avoidance Assist, the vehicle's basic braking performance will operate properly.
- During emergency braking, braking control by Forward Collision-Avoidance Assist will automatically cancel when the driver excessively depresses the accelerator pedal or sharply steers the vehicle.

 **CAUTION**

- Depending on the condition of the vehicle and pedestrian in front and the surroundings, the speed range to operate Forward Collision-Avoidance Assist may reduce. Forward Collision-Avoidance Assist may only warn the driver, or it may not operate.
- Forward Collision-Avoidance Assist will operate under certain conditions by judging the risk level based on the condition of the oncoming vehicle, driving direction, speed and surroundings.



 **Information**

- In a situation where collision is imminent, braking may be assisted by Forward Collision-Avoidance Assist when braking is insufficient by the driver.
- The images and colors in the cluster may differ depending on the cluster type or theme selected from the cluster.

**Forward Collision-Avoidance Assist Malfunction and Limitations**

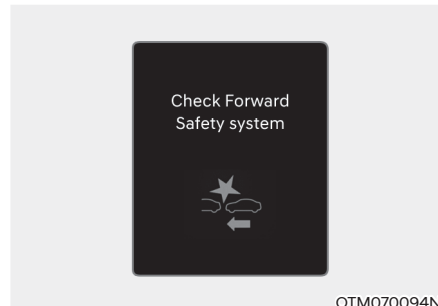
***Forward Collision-Avoidance Assist malfunction***



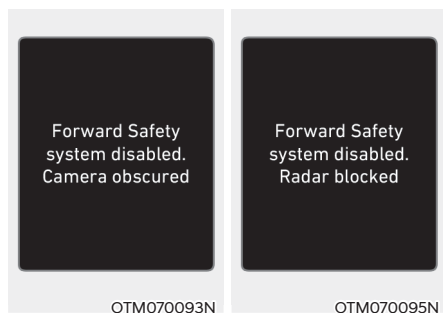

When Forward Collision-Avoidance Assist is not working properly, the 'Check Forward Safety system' warning message appears, and the  and  warning lights illuminate on the cluster. If this occurs, have the vehicle inspected by an authorized HYUNDAI dealer.

### Forward Collision-Avoidance Assist disabled



When the front windshield where the front view camera is located, front radar cover or sensor is covered with foreign material, such as snow or rain, it can reduce the detecting performance and temporarily limit or disable Forward Collision-Avoidance Assist.

If this occurs the 'Forward Safety system disabled. Camera obscured' or the 'Forward Safety system disabled. Radar blocked' warning message, and the  and  warning lights illuminate on the cluster.

Forward Collision-Avoidance Assist will operate properly when when such snow, rain or foreign material is removed.

If Forward Collision-Avoidance Assist does not operate properly after obstruction (snow, rain, or foreign material) is removed, have the vehicle inspected by an authorized HYUNDAI dealer.

### WARNING

- Even though the warning message or warning light does not appear on the cluster, Forward Collision-Avoidance Assist may not properly operate.
- Forward Collision-Avoidance Assist may not properly operate in an area (for example, open terrain), where any objects are not detected after turning ON the engine.

### Limitations of Forward Collision-Avoidance Assist

Forward Collision-Avoidance Assist may not operate properly, or it may operate unexpectedly under the following circumstances:

- The detecting sensor or the surroundings are contaminated or damaged
- The temperature around the front view camera is high or low due to surrounding environment
- The camera lens is contaminated due to tinted, filmed or coated windshield, damaged glass, or sticky foreign material (sticker, bug, etc.) on the glass
- Moisture is not removed or frozen on the windshield
- Washer fluid is continuously sprayed, or the wiper is on
- Driving in heavy rain or snow, or thick fog
- The field of view of the front view camera is obstructed by sun glare
- Street light or light from an oncoming traffic is reflected on the wet road surface, such as a puddle on the road
- An object is placed on the dashboard

- Your vehicle is being towed
- The surrounding is very bright
- The surrounding is very dark, such as in a tunnel, etc.
- The brightness changes suddenly, for example when entering or exiting a tunnel
- The brightness outside is low, and the headlamps are not on or are not bright
- Driving through steam, smoke or shadow
- Only part of the vehicle, pedestrian or cyclist is detected
- The vehicle in front is a bus, heavy truck, truck with an unusually shaped cargo, trailer, etc.
- The vehicle in front has no tail lights, tail lights are located unusually, etc.
- The brightness outside is low, and the tail lamps are not on or are not bright
- The rear of the front vehicle is small or the vehicle does not look normal, such as when the vehicle is tilted, overturned, or the side of the vehicle is visible, etc.
- The front vehicle's ground clearance is low or high
- A vehicle, pedestrian or cyclist suddenly cuts in front
- The bumper around the front radar is impacted, damaged or the front radar is out of position
- The temperature around the front radar is high or low
- Driving through a tunnel or iron bridge
- Driving in large vast where there are few vehicles or structures for example, desert, meadow, suburb, etc.)
- Driving near areas containing metal substances, such as a construction zone, railroad, etc.
- A material is near that reflects very well on the front radar, such as a guardrail, nearby vehicle, etc.
- The cyclist in front is on a bicycle made of material that does not reflect on the front radar
- The vehicle in front is detected late
- The vehicle in front is suddenly blocked by an obstacle
- The vehicle in front suddenly changes lane or suddenly reduces speed
- The vehicle in front is bent out of shape
- The front vehicle's speed is fast or slow
- The vehicle in front steers in the opposite direction of your vehicle to avoid a collision
- With a vehicle in front, your vehicle changes lane at low speed
- The vehicle in front is covered with snow
- You are departing or returning to the lane
- Unstable driving
- You are on a roundabout and the vehicle in front is not detected
- You are continuously driving in a circle
- The vehicle in front has an unusual shape
- The vehicle in front is driving uphill or downhill

- The pedestrian or cyclist is not fully detected, for example, if the pedestrian is leaning over or is not fully walking upright
- The pedestrian or cyclist is wearing clothing or equipment that makes it difficult to detect

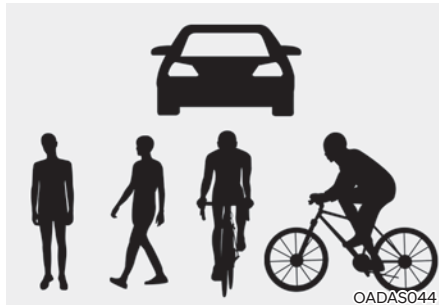

The illustration above shows the image the front view camera and front radar are capable of detecting as a vehicle, pedestrian and cyclist.

- The pedestrian or cyclist in front is moving very quickly
- The pedestrian or cyclist in front is short or is posing a low posture
- The pedestrian or cyclist in front has impaired mobility
- The pedestrian or cyclist in front is moving intersected with the driving direction
- There is a group of pedestrians, cyclists or a large crowd in front
- The pedestrian or cyclist is wearing clothing that easily blends into the background, making it difficult to detect
- The pedestrian or cyclist is difficult to distinguish from the similarly shaped structure in the surroundings
- You are driving by a pedestrian, cyclist, traffic sign, structure, etc., near the intersection
- Driving in a parking lot
- Driving through a tollgate, construction area, unpaved road, partial paved road, uneven road, speed bumps, etc.
- Driving on an incline road, curved road, etc.
- Driving through a roadside with trees or streetlights
- The adverse road conditions cause excessive vehicle vibrations while driving
- Your vehicle height is low or high due to heavy loads, abnormal tire pressure, etc.
- Driving through a narrow road where trees or grass are overgrown
- There is interference by electromagnetic waves, such as driving in an area with strong radio waves or electrical noise



**WARNING**

- Driving on a curved road

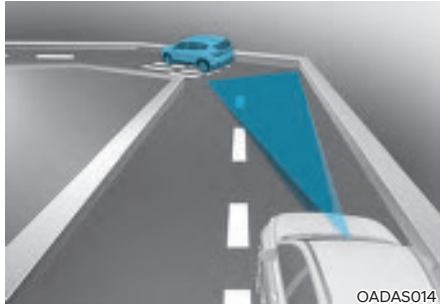

OADAS014

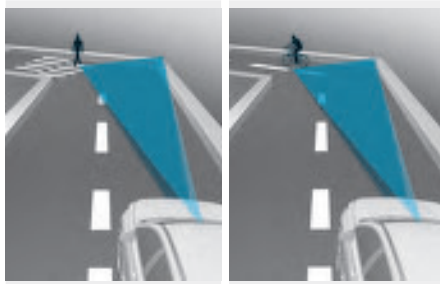

OADAS016

OADAS018

Forward Collision-Avoidance Assist may not detect other vehicles, pedestrians or cyclists in front of you on curved roads adversely affecting the performance of the sensors. This may result in no warning or braking assist when necessary.

When driving on a curved road, you must maintain a safe braking distance, and if necessary, steer the vehicle and depress the brake pedal to reduce your driving speed in order to maintain a safe distance.



OADAS015

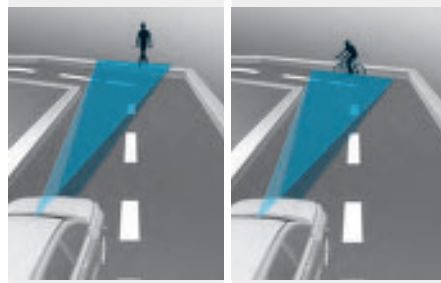

OADAS017

OADAS019

Forward Collision-Avoidance Assist may detect a vehicle, pedestrian or cyclist in the next lane or outside the lane when driving on a curved road.

If this occurs, Forward Collision-Avoidance Assist may unnecessarily warn the driver and control the brake. Always check the traffic conditions around the vehicle.

- Driving on an inclined road

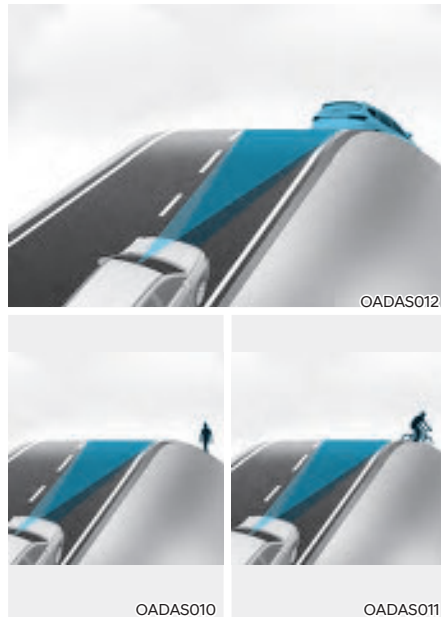

**Forward Collision-Avoidance Assist may not detect other vehicles, pedestrians or cyclists in front of you while driving uphill or downhill adversely affecting the performance of the sensors.**

**This may result in unnecessary warning or braking assist, or no warning or braking assist when necessary.**

**Also, vehicle speed may rapidly decrease when a vehicle, pedestrian or cyclist ahead is suddenly detected.**

**Always have your eyes on the road while driving uphill or downhill and if necessary, steer your vehicle and depress the brake pedal to reduce your driving speed in order to maintain a safe distance.**

- Changing lanes



[A] : Your vehicle,  
[B] : Lane changing vehicle

**When a vehicle moves into your lane from an adjacent lane, it cannot be detected by the sensor until it is in the sensor's detection range. Forward Collision-Avoidance Assist may not immediately detect the vehicle when the vehicle changes lanes abruptly. In this case, you must maintain a safe braking distance, and if necessary, steer your vehicle and depress the brake pedal to reduce your driving speed in order to maintain a safe distance.**

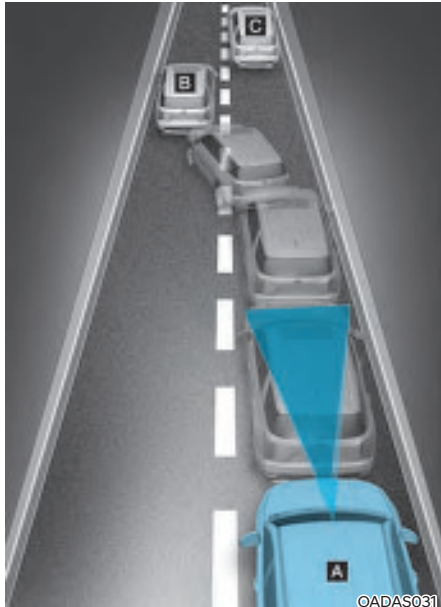

[A] : Your vehicle, [B] : Lane changing vehicle,  
[C] : Same lane vehicle

**When a vehicle in front of you merges out of the lane, Forward Collision-Avoidance Assist may not immediately detect the vehicle that is now in front of you. In this case, you must maintain a safe braking distance, and if necessary, steer your vehicle and depress the brake pedal to reduce your driving speed in order to maintain a safe distance.**

- **Detecting vehicle**

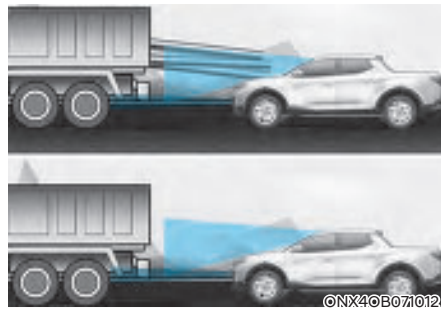

**If the vehicle in front of you has cargo that extends rearward from the cab, or when the vehicle in front of you has higher ground clearance, additional special attention is required. Forward Collision-Avoidance Assist may not be able to detect the cargo extending from the vehicle. In these instances, you must maintain a safe braking distance from the rearmost object, and if necessary, steer your vehicle and depress the brake pedal to reduce your driving speed in order to maintain distance.**



 **WARNING**

- When you are towing a trailer or another vehicle, we recommend that Forward Collision-Avoidance Assist is turned off due to safety reasons.
- Forward Collision-Avoidance Assist may operate if objects that are similar in shape or characteristics to vehicles, pedestrians and cyclists are detected.
- Forward Collision-Avoidance Assist does not operate on bicycles, motorcycles, or smaller wheeled objects, such as luggage bags, shopping carts, or strollers.
- Forward Collision-Avoidance Assist may not operate properly if interfered by strong electromagnetic waves.
- Forward Collision-Avoidance Assist may not operate for 15 seconds after the vehicle is started, or the front view camera is initialized.

 **Information**

This device complies with Part 15 of the FCC rules.

Operation is subject to the following three conditions:

1. This device may not cause harmful interference, and
2. This device must accept any interference received, including interference that may cause undesired operation.
3. Changes or modifications not expressly approved by the party responsible for compliance could void the user's authority to operate the device.

 **Information**

Radio frequency radiation exposure information:

This equipment complies with FCC radiation exposure limits set forth for an uncontrolled environment.

This equipment should be installed and operated with minimum distance of 8 in. (20 cm) between the radiator (antenna) and your body.

This transmitter must not be co-located or operating in conjunction with any other antenna or transmitter.

## LANE KEEPING ASSIST (LKA)

Lane Keeping Assist is designed to help detect lane markings (or road edges) while driving over a certain speed. Lane Keeping Assist will warn the driver if the vehicle leaves the lane without using the turn signal, or will automatically assist the driver's steering to help prevent the vehicle from departing the lane.

### Detecting sensor



[1] : Front view camera

The front view camera is used as a detecting sensor to detect lane markings (or road edges).

Refer to the picture above for the detailed location of the detecting sensor.



### CAUTION

For more details on the precautions of the front view camera, refer to “Forward Collision-Avoidance Assist (FCA)” section in chapter 7.

## Lane Keeping Assist Settings

### Setting features

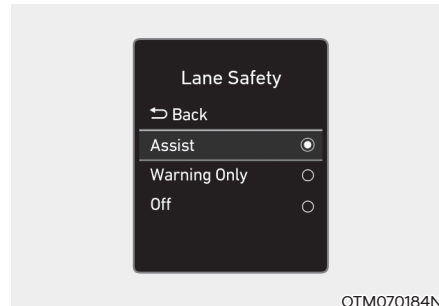

### Lane Safety

With the engine on, select 'Driver Assistance → Lane Safety' from the Settings menu to set whether to use each function.

- If 'Assist' is selected, Lane Keeping Assist will automatically assist the driver's steering when lane departure is detected to help prevent the vehicle from moving out of its lane.
- If 'Warning Only' is selected, Lane Keeping Assist will warn the driver with an audible warning when lane departure is detected. The driver must steer the vehicle.
- If 'Off' is selected, Lane Keeping Assist turns off. The  indicator light turns off on the cluster.



### WARNING

- If 'Warning Only' is selected, steering is not assisted.
- Lane Keeping Assist does not control the steering wheel when the vehicle is driven in the middle of the lane.
- The driver should always be aware of the surroundings and steer the vehicle if 'Off' is selected.

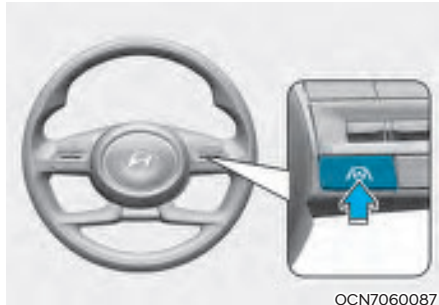

OCN7060087

#### Turning Lane Keeping Assist On/Off (Using the Lane Driving Assist button on the steering wheel)

With the engine on, press and hold the Lane Driving Assist button located on the steering wheel to turn on Lane Keeping Assist. The white  indicator light illuminates on the cluster.

Press and hold the button again to turn off the function.

If the engine is restarted, Lane Keeping Assist will maintain the last setting.

#### Information

The Lane Driving Assist button is used for both the Lane Keeping Assist function and the Lane Following Assist function.

Note that quickly pressing and releasing the button will enable or disable the Lane Following Assist feature, whereas pressing and holding the button will enable or disable the Lane Keeping Assist feature.

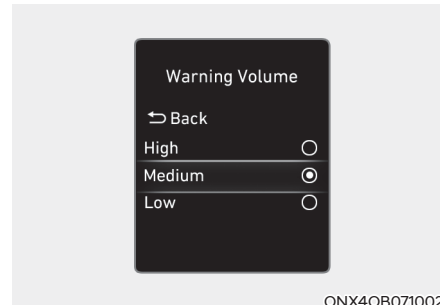

ONX40B071002

#### Warning Volume

With the engine on, select 'Driver Assistance → Warning Volume' from the Settings menu to change the Warning Volume to 'High', 'Medium' or 'Low' for Lane Keeping Assist.

If you change the Warning Volume, the Warning Volume of other Driver Assistance systems may change.

### Lane Keeping Assist Operation *Warning and control*

Lane Keeping Assist will warn and help control the vehicle with Lane Departure Warning and Lane Keeping Assist.



#### Lane Departure Warning

- To warn the driver that the vehicle is departing from the projected lane in front, the green  indicator light will blink on the cluster, the lane line will blink on the cluster depending on which direction the vehicle is veering, and an audible warning will sound.
- Lane Keeping Assist will operate when your vehicle speed is between approximately 40-120 mph (60-200 km/h).

#### Lane Keeping Assist

- To warn the driver that the vehicle is departing from the projected lane in front, the green  indicator light will blink on the cluster, and the steering wheel will make adjustments to keep the vehicle inside the lane.
- Lane Keeping Assist will operate when your vehicle speed is between approximately 40-120 mph (60-200 km/h).

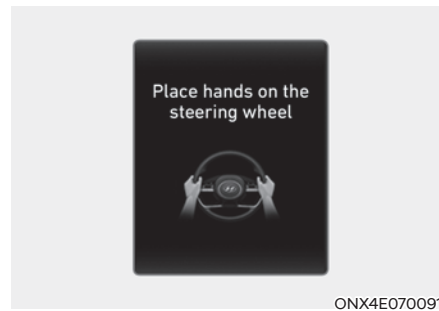

#### Hands-off warning

If the driver takes their hands off the steering wheel for several seconds, the 'Place hands on the steering wheel' warning message appears on the cluster, and an audible warning sounds in stages.

### WARNING

- The Lane Keeping steering wheel effort can be overcome if the steering wheel is held tightly or if the driver steers the vehicle beyond a certain angle.
- Lane Keeping Assist does not operate at all times. It is the responsibility of the driver to safely steer the vehicle and to maintain the vehicle in its lane.
- The hands-off warning message may appear late depending on road conditions. Always have your hands on the steering wheel while driving.
- If the steering wheel is held very lightly, the hands-off warning message may appear because Lane Keeping Assist may not recognize that the driver has their hands on the steering wheel.
- If you attach objects to the steering wheel, the hands-off warning may not work properly.

### Information

- You may change settings from the instrument cluster (User Settings) or infotainment system (Vehicle Settings), whichever option that is provided with your vehicle. For more details, see "User Settings" section in chapter 4, or "Vehicle Settings" section in supplied Infotainment Manual.
- When lane markings (or road edges) are detected, the lane lines on the cluster will change from grey to white and the green  indicator light illuminates.

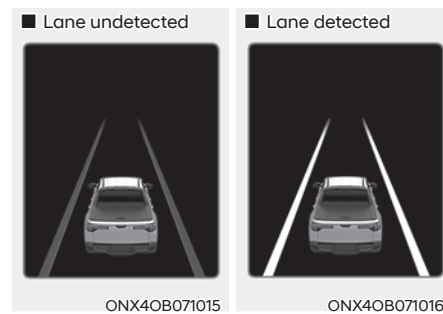

- Even though the steering is assisted by Lane Keeping Assist, the driver may control the steering wheel.
- The steering wheel may feel heavier or lighter when the steering wheel is assisted by Lane Keeping Assist than when it is not.

## Lane Keeping Assist Malfunction and Limitations

### Lane Keeping Assist malfunction



When Lane Keeping Assist is not working properly, the 'Check Lane Keeping Assist (LKA) system' warning message appears and the yellow  indicator light illuminates on the cluster. If this occurs, have the vehicle inspected by an authorized HYUNDAI dealer.

### Limitations of Lane Keeping Assist

Lane Keeping Assist may not operate properly or may operate unexpectedly under the following circumstances:

- The lane is contaminated or difficult to detect because:
  - The lane markings (or road edge) are covered with rain, snow, dirt, oil, etc.
  - The color of the lane marking (or road edge) is not distinguishable from the road
  - There are markings (or road edges) on the road near the lane or the markings (or road edges) on the road look similar to the lane markings (or road edge)
  - The lane marking (or road edge) is indistinct or damaged
  - The shadow is on the lane marking (or road edge) by a median strip, trees, guardrail, noise barriers, etc.
- There are more than two lane markings (or road edges) on the road
- The lane number increases or decreases, or the lane markings (or road edges) are crossing
- The lane markings (or road edges) are complicated or a structure substitutes for the lines, such as a construction area
- There are road markings, such as zigzag lanes, crosswalk markings and road signs
- The lane suddenly disappears, such as at the intersection
- The lane (or road width) is very wide or narrow

- There is a road edge without a lane
- There is a boundary structure in the roadway, such as a tollgate, sidewalk, curb, etc.
- The distance to the front vehicle is extremely short or the vehicle in front is covering the lane marking (or road edge)

### Information

For more details on the limitations of the front view camera, refer to “Forward Collision-Avoidance Assist (FCA)” section in chapter 7.



### WARNING

Take the following precautions when using Lane Keeping Assist:

- The driver should hold the responsibility to safely drive and control the vehicle. Do not solely rely on Lane Keeping Assist and drive dangerously.
- The operation of Lane Keeping Assist can be cancelled or not work properly depending on road conditions and surroundings. Always be cautious while driving.
- Refer to “Limitations of Lane Keeping Assist” if the lane is not detected properly.
- When you are towing a trailer or another vehicle, we recommend that Lane Keeping Assist is turned off due to safety reasons.
- If the vehicle is driven at high speed, the steering wheel will not be controlled. The driver must always follow the speed limit when using Lane Keeping Assist.
- If any other system’s warning message is displayed or audible warning is generated, Lane Keeping Assist warning message may not be displayed and audible warning may not be generated.
- You may not hear the warning sound of Lane Keeping Assist if the surrounding is noisy.
- If you attach objects to the steering wheel, steering may not be assisted properly.
- Lane Keeping Assist may not operate for 15 seconds after the vehicle is started, or the front view camera is initialized.
- Lane Keeping Assist will not operate when:
  - The turn signal or hazard warning flasher is turned on
  - The vehicle is not driven in the center of the lane when Lane Keeping Assist is turned on or right after changing a lane
  - ESC (Electronic Stability Control) or VSM (Vehicle Stability Management) is activated
  - The vehicle is driven on a sharp curve
  - Below 35 mph (55 km/h) or above 130 mph (210 km/h)
  - The vehicle makes sharp lane changes
  - The vehicle brakes suddenly

## BLIND-SPOT COLLISION-AVOIDANCE ASSIST (BCA) (IF EQUIPPED)

Blind-Spot Collision-Avoidance Assist is designed to help detect and monitor approaching vehicles in the driver's blind spot area and warn the driver of a possible collision with a warning message and audible warning.

In addition, if there is a risk of collision when changing lanes or attempting to enter into the flow of traffic from a parallel parking space, Blind-Spot Collision-Avoidance Assist can help avoid a collision by applying the brake.

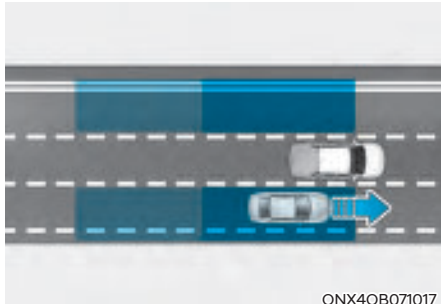

ONX4OB071017

Blind-Spot Collision-Avoidance Assist helps detect and inform the driver that a vehicle is in the blind spot.

### CAUTION

The detecting range may vary depending on the speed of your vehicle. Even if there is a vehicle in the blind spot area, Blind-Spot Collision-Avoidance Assist may not warn you when you pass by at high speeds.

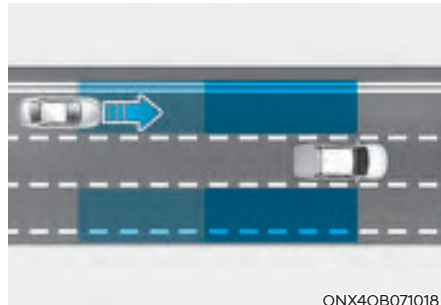

ONX4OB071018

Blind-Spot Collision-Avoidance Assist helps detect and informs the driver that a vehicle is approaching at high speed from the blind spot area.

### CAUTION

Warning timing may vary depending on the speed of the vehicle approaching at high speed.

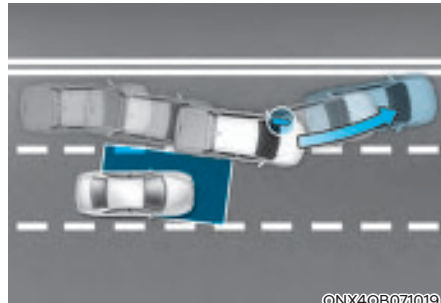

ONX4OB071019

When changing lanes by detecting the lane ahead, if Blind-Spot Collision-Avoidance Assist judges that there is a collision risk with an approaching vehicle in the blind spot, it can help avoid a collision by applying the brake.



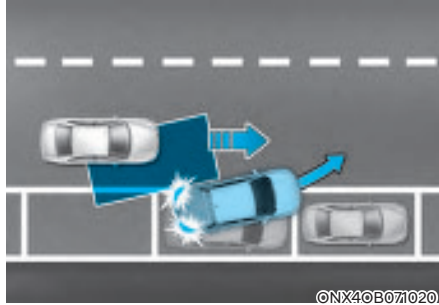

When your vehicle is entering into the flow of traffic from a parallel parking space, if Blind-Spot Collision-Avoidance Assist judges that there is a collision risk with an approaching vehicle in the blind spot, it can help avoid a collision by applying the brake.

### Detecting sensor



[1] : Front view camera,  
[2] : Rear corner radar

Refer to the picture above for the detailed location of the detecting sensors.



### CAUTION

Take the following precautions to maintain optimal performance of the detecting sensor:

- Never disassemble the rear corner radar or radar assembly, or cause any damage to it.
- If the rear corner radar or near the radar has been damaged or impacted in any way, even though the warning message does not appear on the cluster, Blind-Spot Collision-Avoidance Assist may not operate properly. Have the vehicle inspected by an authorized HYUNDAI dealer.
- If the rear corner radars have been replaced or repaired, have the vehicle inspected by an authorized HYUNDAI dealer.
- Use only genuine parts to repair the rear bumper where the rear corner radar is located.
- Do not apply license plate frame or objects, such as a bumper sticker, film or a bumper guard near the rear corner radar.
- Blind-Spot Collision-Avoidance Assist may not work properly if the bumper has been replaced, or the surroundings of the rear corner radar have been damaged or paint has been applied.
- If a trailer, carrier, etc., is installed, it may adversely affect the performance of the rear corner radar or Blind-Spot Collision-Avoidance Assist may not operate.
- For more details on the precautions of the front view camera, refer to “Forward Collision-Avoidance Assist (FCA)” section in chapter 7.

## Blind-Spot Collision-Avoidance Assist Settings

### Setting features

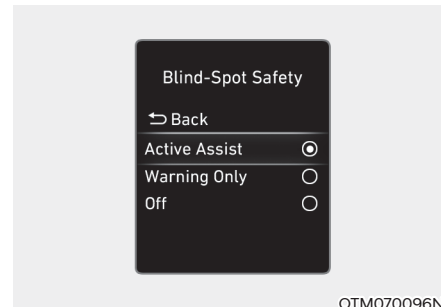

### Blind-Spot Safety

With the engine on, select ‘Driver Assistance → Blind-Spot Safety’ from the Settings menu to set whether to use each function.

- If ‘Active Assist’ is selected, Blind-Spot Collision-Avoidance Assist will warn the driver with a warning message, an audible warning and braking assist will be applied depending on the collision risk levels.
- If ‘Warning Only’ is selected, Blind-Spot Collision-Avoidance Assist will warn the driver with a warning message and an audible warning depending on the collision risk levels. Braking will not be assisted.
- If ‘Off’ is selected, Blind-Spot Collision-Avoidance Assist turns off.



When the engine is restarted with Blind-Spot Collision-Avoidance Assist off, the 'Blind-Spot Safety System is Off' message appears on the cluster.

If you change the setting from 'Off' to 'Active Assist' or 'Warning Only', the warning light on the side view mirror blinks for three seconds.

In addition, if the engine is turned on, when Blind-Spot Collision-Avoidance Assist is set to 'Active Assist' or 'Warning Only', the warning light on the side view mirror blinks for three seconds.



#### WARNING

- If 'Warning Only' is selected, braking is not assisted.
- If 'Off' is selected, the driver should always be aware of the surroundings and drive safely.



#### Information

If the engine is restarted, Blind-Spot Collision-Avoidance Assist will maintain the last setting.

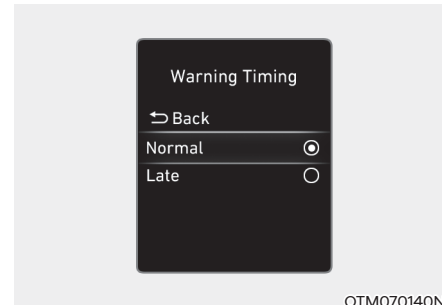

#### Warning Timing

With the engine on, select 'Driver Assistance → Warning Timing' from the Settings menu to change the initial warning activation time for Blind-Spot Collision-Avoidance Assist.

When the vehicle is first delivered, Warning Timing is set to 'Normal'. If you change the Warning Timing, the Warning Timing of other Driver Assistance systems may change.

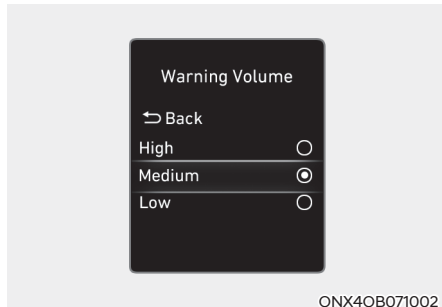

ONX4OB071002

### Warning Volume

With the engine on, select 'Driver Assistance → Warning Volume' from the Settings menu to change the Warning Volume to 'High', 'Medium' or 'Low' for Blind-Spot Collision-Avoidance Assist.

If you change the Warning Volume, the Warning Volume of other Driver Assistance systems may change.



### CAUTION

- **The setting of the Warning Timing and Warning Volume applies to all functions of Blind-Spot Collision-Avoidance Assist.**
- **Even though 'Normal' is selected for Warning Timing, a vehicle approaches at high speed, the warning may seem late.**
- **Select 'Late' for Warning Timing when traffic is light and when driving speed is slow.**

## Blind-Spot Collision-Avoidance Assist Operation

### Warning and control



OPDEN060039

### Vehicle Detection

- To warn the driver a vehicle is detected, the warning light on the side view mirror illuminates.
- Blind-Spot Collision-Avoidance Assist operates when your vehicle speed is above 12 mph (20 km/h) and the speed of the vehicle in the blind spot area is above 7 mph (10 km/h).

### Collision Warning

- Collision warning operates when the turn signal is turned on in the direction of the detected vehicle.
- If 'Warning Only' is selected from the Settings menu, the collision warning operates when your vehicle approaches the lane the blind spot vehicle is detected.
- To warn the driver of a collision, the warning light on the side view mirror blinks. At the same time, an audible warning sounds.
- When the turn signal is turned off or you move away from the lane, the collision warning will be canceled and Blind-Spot Collision-Avoidance Assist will return to vehicle detection state.



### WARNING

- The detecting range of the rear corner radar is determined by a standard road width, therefore, on a narrow road, Blind-Spot Collision-Avoidance Assist may detect other vehicles in two lanes over and warn you. In contrast, on a wide road, Blind-Spot Collision-Avoidance Assist may not be able to detect a vehicle driving in the next lane and may not warn you.
- When the hazard warning flasher is on, the collision warning by the turn signal will not operate.



### Information

If the driver's seat is on the left side, the collision warning may occur when you turn left. Maintain a proper distance with the vehicles in the left lane. If the driver's seat is on the right side, the collision warning may occur when you turn right. Maintain a proper distance with the vehicles in the right lane.

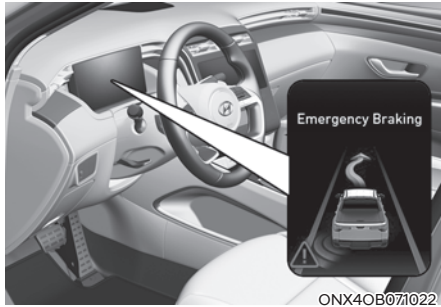

**Collision-Avoidance Assist (while driving)**

- To warn the driver of a collision, the warning light on the side view mirror blinks and a warning message appears on the cluster. At the same time, an audible warning sounds.
- Blind-Spot Collision-Avoidance Assist operates when your vehicle speed is between 40-120 mph (60-200 km/h) and both lane markings of the driving lane are detected.
- Emergency braking is assisted to help prevent collision with the vehicle in the blind spot area.

 **WARNING**

- **Collision-Avoidance Assist is canceled under the following circumstances:**
  - Your vehicle enters the next lane by a certain distance
  - Your vehicle is away from the collision risk
  - The steering wheel is sharply steered
  - The brake pedal is depressed
  - Forward Collision-Avoidance Assist is operating
- **After Blind-Spot Collision-Avoidance Assist operation or lane change, you must drive to the center of the lane. Blind-Spot Collision-Avoidance Assist will not operate if the vehicle is not driven in the center of the lane.**

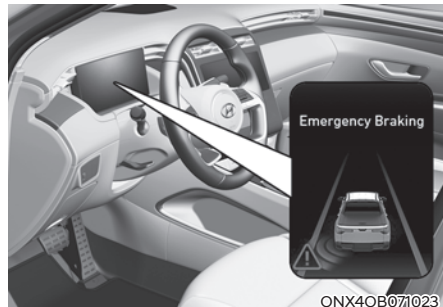

ONX4OB071023

#### Collision-Avoidance Assist (while departing)

- To warn the driver of a collision, the warning light on the side view mirror blinks and a warning message appears on the cluster. At the same time, an audible warning sounds.
- Blind-Spot Collision-Avoidance Assist operates when your vehicle speed is below 2 mph (3 km/h) and the speed of the vehicle in the blind spot area is above 3 mph (5 km/h).
- Emergency braking is assisted to help prevent collision with the vehicle in the blind spot area.



ONX4OB071005

- When the vehicle is stopped due to emergency braking, the 'Drive carefully' warning message appears on the cluster.  
For your safety, the driver should depress the brake pedal immediately and check the surroundings.
- Brake control ends after the vehicle is stopped by emergency braking for approximately 2 seconds.



### WARNING

Take the following precautions when using Blind-Spot Collision- Avoidance Assist :

- For your safety, change the Settings after parking the vehicle at a safe location.
- If any other system's warning message is displayed or audible warning is generated, Blind-Spot Collision- Avoidance Assist's warning message may not be displayed and audible warning may not be generated.
- You may not hear the warning sound of Blind-Spot Collision- Avoidance Assist if the surrounding is noisy.
- Blind-Spot Collision- Avoidance Assist may not operate if the driver applies the brake pedal to avoid collision.
- When Blind-Spot Collision- Avoidance Assist is operating, braking control by the function will automatically cancel when the driver excessively depresses the accelerator pedal or sharply steers the vehicle.
- During Blind-Spot Collision- Avoidance Assist operation, the vehicle may stop suddenly injuring passengers and shifting loose objects. Always have the seat belt on and keep loose objects secured.
- Even if there is a problem with Blind-Spot Collision- Avoidance Assist, the vehicle's basic braking performance will operate properly.
- Blind-Spot Collision- Avoidance Assist does not operate in all situations or cannot avoid all collisions.

- Blind-Spot Collision- Avoidance Assist may warn the driver late or may not warn the driver depending on the road and driving conditions.
- Driver should maintain control of the vehicle at all times. Do not depend on Blind-Spot Collision- Avoidance Assist. Maintain a safe braking distance, and if necessary, depress the brake pedal to reduce driving speed or to stop the vehicle.
- Never operate Blind-Spot Collision- Avoidance Assist on people, animal, objects, etc. It may cause serious injury or death.



### WARNING

The brake control may not operate properly depending on the status of ESC (Electronic Stability Control).

There will only be a warning when:

- The ESC (Electronic Stability Control) warning light is on
- ESC (Electronic Stability Control) is engaged in a different function



## Blind-Spot Collision-Avoidance Assist Malfunction and Limitations

### *Blind-Spot Collision-Avoidance Assist malfunction*

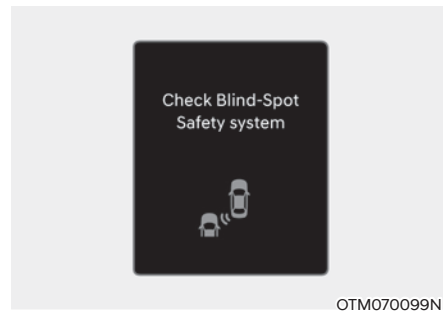

When Blind-Spot Collision-Avoidance Assist is not working properly, the 'Check Blind-Spot Safety system' warning message appears on the cluster for several seconds, and the master (⚠) warning light illuminates on the cluster. If this occurs, have the vehicle inspected by an authorized HYUNDAI dealer.

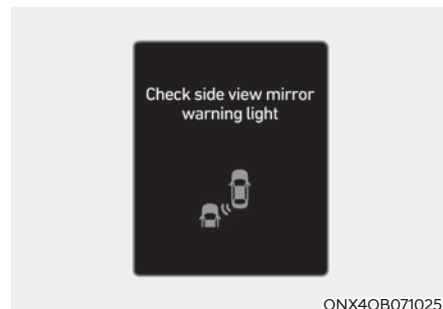

When the side view mirror warning light is not working properly, the 'Check side view mirror warning light' warning message appears on the cluster for several seconds, and the master (⚠) warning light illuminates on the cluster. If this occurs, have the vehicle inspected by an authorized HYUNDAI dealer.

### *Blind-Spot Collision-Avoidance Assist disabled*

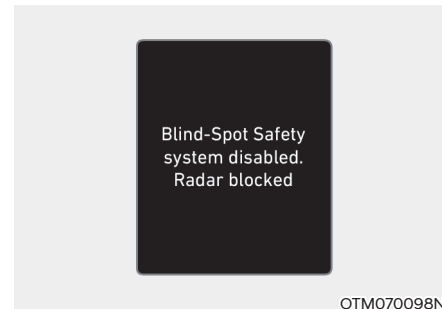

When the rear bumper around the rear corner radar or sensor is covered with foreign material, such as snow or rain, or installing a trailer or carrier, it can reduce the detecting performance and temporarily limit or disable Blind-Spot Collision-Avoidance Assist.

If this occurs, the 'Blind-Spot Safety system disabled. Radar blocked' warning message appears on the cluster.

Blind-Spot Collision-Avoidance Assist will operate properly when such foreign material or trailer, etc., is removed, and then the engine is restarted.

If Blind-Spot Collision-Avoidance Assist does not operate properly after it is removed, have the vehicle inspected by an authorized HYUNDAI dealer.

### **WARNING**

- Even though the warning message does not appear on the cluster, Blind-Spot Collision-Avoidance Assist may not properly operate.
- Blind-Spot Collision-Avoidance Assist may not properly operate in an area (for example, open terrain) where any objects are not detected right after the engine is turned on, or when the detecting sensor is blocked with foreign material right after the engine is turned on.



### CAUTION

**Turn off Blind-Spot Collision-Avoidance Assist to install or remove a trailer, carrier, or another attachment. Turn on Blind-Spot Collision-Avoidance Assist when finished.**

#### ***Limitations of Blind-Spot Collision-Avoidance Assist***

Blind-Spot Collision-Avoidance Assist may not operate properly, or it may operate unexpectedly under the following circumstances:

- There is inclement weather, such as heavy snow, heavy rain, etc.
- The rear corner radar is covered with snow, rain, dirt, etc.
- The temperature around the rear corner radar is high or low
- Driving on a highway ramp
- The road pavement (or the peripheral ground) abnormally contains metallic components (for example, possibly due to subway construction)
- There is a fixed object near the vehicle, such as sound barriers, guardrails, central dividers, entry barriers, street lamps, signs, tunnels, walls, etc. (including double structures)
- Driving in vast areas where there are few vehicles or structures (for example, desert, meadow, suburb, etc.)
- Driving through a narrow road where trees or grass are overgrown
- Driving on a wet road surface, such as a puddle on the road
- The other vehicle drives very close behind your vehicle, or the other vehicle passes by your vehicle in close proximity

- The speed of the other vehicle is very fast that it passes by your vehicle in a short time
- Your vehicle passes by the other vehicle
- Your vehicle changes lane
- Your vehicle has started at the same time as the vehicle next to you and has accelerated
- The vehicle in the next lane moves two lanes away from you, or when the vehicle two lanes away moves to the next lane from you
- A trailer, carrier or other attachment is installed around the rear corner radar
- The bumper around the rear corner radar is covered with objects, such as a bumper sticker, bumper guard, bike rack, etc.
- The bumper around the rear corner radar is impacted, damaged or the radar is out of position
- Your vehicle height is low or high due to heavy loads, abnormal tire pressure, etc.

Blind-Spot Collision-Avoidance Assist may not operate properly, or it may operate unexpectedly when the following objects are detected:

- A motorcycle or bicycle is detected
- A vehicle such as a flat trailer is detected
- A big vehicle such as a bus or truck is detected
- A moving obstacle such as a pedestrian, animal, shopping cart or a baby stroller is detected
- A vehicle with low height such as a sports car is detected

Braking control may not work, driver's attention is required in the following circumstances:

- The vehicle severely vibrates while driving over a bumpy road, uneven road or concrete patch
- Driving on a slippery surface due to snow, water puddle, ice, etc.
- The tire pressure is low or a tire is damaged
- The brake is tuned
- The vehicle makes abrupt lane changes

### **i** Information

For more details on the limitations of the front view camera, refer to “Forward Collision-Avoidance Assist (FCA)” and “Lane Keeping Assist (LKA)” section in chapter 7.

### **⚠** WARNING

- Driving on a curved road



**Blind-Spot Collision-Avoidance Assist may not operate properly when driving on a curved road. The function may not detect the vehicle in the next lane.**

**Always pay attention to road and driving conditions while driving.**



**Blind-Spot Collision-Avoidance Assist may not operate properly when driving on a curved road. The function may recognize a vehicle in the same lane.**

**Always pay attention to road and driving conditions while driving.**

- Driving where the road is merging/dividing

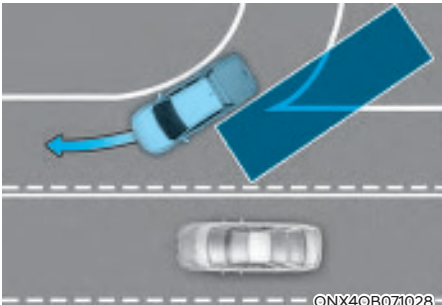

**Blind-Spot Collision-Avoidance Assist** may not operate properly when driving where the road merges or divides. The function may not detect the vehicle in the next lane. Always pay attention to road and driving conditions while driving.

- Driving on an inclined road

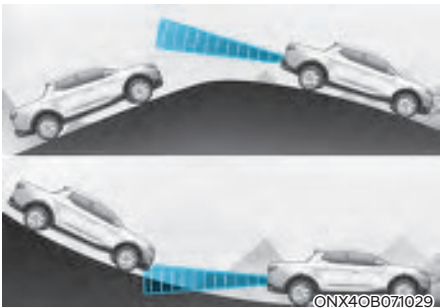

**Blind-Spot Collision-Avoidance Assist** may not operate properly when driving on a slope. The function may not detect the vehicle in the next lane or may incorrectly detect the ground or structure. Always pay attention to road and driving conditions while driving.

- Driving where the heights of the lanes are different

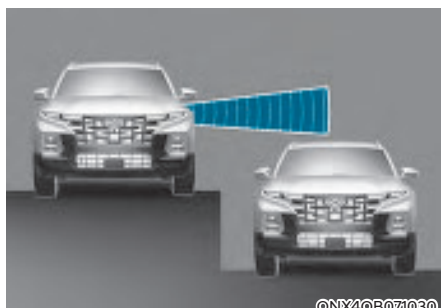

Blind-Spot Collision-Avoidance Assist may not operate properly when driving where the heights of the lanes are different. The function may not detect the vehicle on a road with different lane heights (underpass joining section, grade separated intersections, etc.).

Always pay attention to road and driving conditions while driving.

#### **WARNING**

- When you are towing a trailer or another vehicle, make sure that you turn off Blind-Spot Collision-Avoidance Assist.
- Blind-Spot Collision-Avoidance Assist may not operate properly if interfered by strong electromagnetic waves.
- Blind-Spot Collision-Avoidance Assist may not operate for 3 seconds after the vehicle is started, or the front view camera or rear corner radars are initialized.

#### **Information**

This device complies with Part 15 of the FCC rules.

Operation is subject to the following three conditions:

1. This device may not cause harmful interference, and
2. This device must accept any interference received, including interference that may cause undesired operation.
3. Changes or modifications not expressly approved by the party responsible for compliance could void the user's authority to operate the device.

#### **Information**

Radio frequency radiation exposure information:

This equipment complies with FCC radiation exposure limits set forth for an uncontrolled environment.

This equipment should be installed and operated with minimum distance of 8 in. (20 cm) between the radiator (antenna) and your body.

This transmitter must not be co-located or operating in conjunction with any other antenna or transmitter.

## SAFE EXIT WARNING (SEW) (IF EQUIPPED)

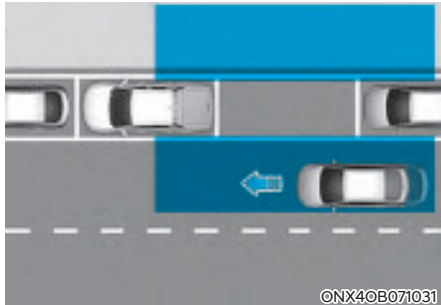

Safe Exit Warning is designed to monitor traffic in an adjacent lane after your vehicle is stopped and parked. If the function detects an approaching vehicle, Safe Exit Warning will warn the driver through an audible alert and a warning message to deter the driver or passenger from opening the door in front of oncoming traffic.



### CAUTION

Warning timing may vary depending on the speed of the approaching vehicle.

### Detecting sensor



[1] : Rear corner radar

Refer to the picture above for the detailed location of the detecting sensors.



### CAUTION

For more details on the precautions of the rear corner radars, refer to “Blind-Spot Collision-Avoidance Assist (BCA)” section in chapter 7.

## Safe Exit Warning Settings

### Setting features



#### Safe Exit Warning

With the engine on, select 'Driver Assistance → Blind-Spot Safety → Safe Exit Warning' from the Settings menu to turn on Safe Exit Warning and deselect to turn off the function.



#### **WARNING**

The driver should always be aware of his or her surroundings. If 'Safe Exit Warning' is deselected, Safe Exit Warning cannot assist you.



#### **Information**

If the engine is restarted, Safe Exit Warning will maintain the last setting.



#### Warning Timing

With the engine on, select 'Driver Assistance → Warning Timing' from the Settings menu to change the initial warning activation time for Safe Exit Warning.

When the vehicle is first delivered, Warning Timing is set to 'Normal'. If you change the Warning Timing, the Warning Timing of other Driver Assistance systems may change.

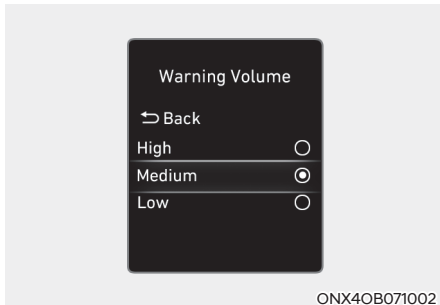

ONX4OB071002

### Warning Volume

With the engine on, select 'Driver Assistance → Warning Volume' from the Settings menu to change the Warning Volume to 'High', 'Medium' or 'Low' for Safe Exit Warning.

If you change the Warning Volume, the Warning Volume of other Driver Assistance systems may change.



### CAUTION

- The setting of the Warning Timing and Warning Volume applies to all functions of the Safe Exit Warning.
- Even though 'Normal' is selected for Warning Timing, if a vehicle approaches at high speed from the rear, the warning may seem late.
- Select 'Late' for Warning Timing when traffic is light and when driving speed is slow.

## Safe Exit Warning Operation

### Safe Exit warning

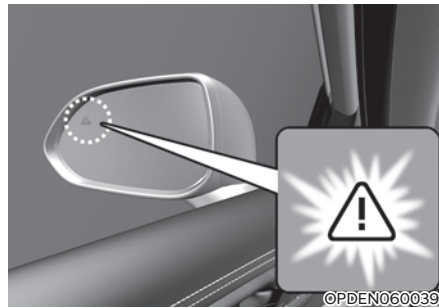

OPDEN060039

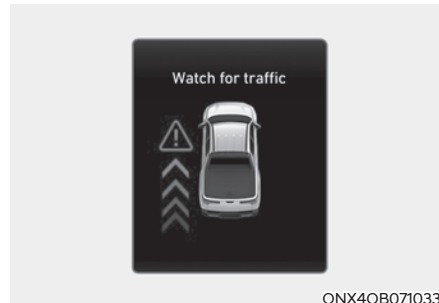

ONX4OB071033

### Collision warning when exiting vehicle

- When an approaching vehicle from the rear is detected at the moment a door is opened, the 'Watch for traffic' warning message appears on the cluster, and an audible warning sounds.
- Safe Exit Warning warns the driver when your vehicle speed is below 2 mph (3 km/h), and the speed of the approaching vehicle from the rear is above 3 mph (5 km/h).





### WARNING

Take the following precautions when using Safe Exit Warning:

- For your safety, change the Settings after parking the vehicle at a safe location.
- If any other function's warning message is displayed or audible warning is generated, Safe Exit Warning's warning message may not be displayed and audible warning may not be generated.
- You may not hear the warning sound of Safe Exit Warning if the surrounding is noisy.
- Safe Exit Warning does not operate in all situations or cannot prevent all collisions.
- Safe Exit Warning may warn the driver late or may not warn the driver depending on the road and driving conditions. Always check vehicle surroundings.

- The driver and passengers are responsible for accidents that occurs while exiting the vehicle. Always check the surroundings before you exit the vehicle.
- Never deliberately operate Safe Exit Warning. Doing so may lead to serious injury or death.
- Safe Exit Warning does not operate if there is a problem with Blind-Spot Collision-Avoidance Assist. The warning message of Blind-Spot Collision-Avoidance Assist appears when:
  - Blind-Spot Collision-Avoidance Assist sensor or the sensor surrounding is polluted or covered
  - Blind-Spot Collision-Avoidance Assist fails to warn passengers or falsely warn passengers



### Information

After the engine is turned off, Safe Exit Warning operates approximately for 3 minutes, but turns off immediately if the doors are locked.

## Safe Exit Warning Malfunction and Limitations

### Safe Exit Warning malfunction



When Safe Exit Warning is not working properly, the 'Check Blind-Spot Safety system' warning message appears on the cluster for several seconds, and the master (⚠) warning light illuminates on the cluster. If this occurs, have the vehicle inspected by an authorized HYUNDAI dealer.

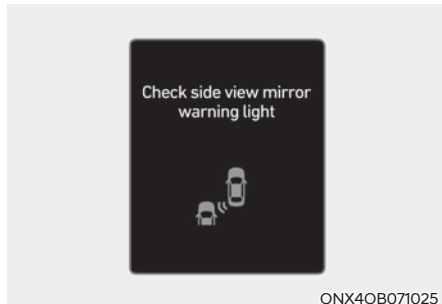

When the side view mirror warning light is not working properly, the 'Check side view mirror warning light' warning message appears on the cluster for several seconds, and the master (⚠) warning light illuminates on the cluster. If this occurs, have the vehicle inspected by an authorized HYUNDAI dealer.

### Safe Exit Warning disabled

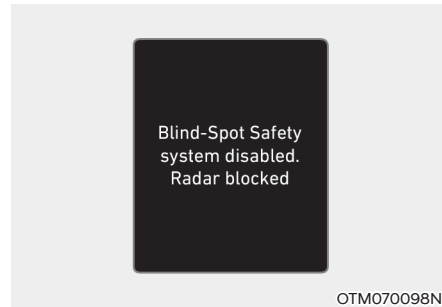

When the rear bumper around the rear corner radar or sensor is covered with foreign material, such as snow or rain, or installing a trailer or carrier, it can reduce the detecting performance and temporarily limit or disable Safe Exit Warning.

If this occurs, the 'Blind-Spot Safety system disabled. Radar blocked' warning message appears on the cluster.

Safe Exit Warning will operate properly when such foreign material or trailer, etc., is removed, and then the engine is restarted.

If Safe Exit Warning does not operate properly after it is removed, have the vehicle inspected by an authorized HYUNDAI dealer.

 **WARNING**

- Even though the warning message does not appear on the cluster, Safe Exit Warning may not properly operate.
- Safe Exit Warning may not properly operate in an area (for example, open terrain) where any objects are not detected right after the engine is turned on, or when the detecting sensor is blocked with foreign material right after the engine is turned on.

 **CAUTION**

Turn off Safe Exit Warning to install or remove a trailer, carrier, or another attachment. Turn on Safe Exit Warning when finished.

**Limitations of Safe Exit Warning**

Safe Exit Warning may not operate properly, or it may operate unexpectedly under the following circumstances:

- Getting out of the vehicle where trees or grass are overgrown
- Getting out of the vehicle where the road is wet
- The approaching vehicle is very fast or very slow

 **Information**

For more details on the limitations of the rear corner radar, refer to “Blind-Spot Collision-Avoidance Assist (BCA)” section in this chapter.

 **WARNING**

- Safe Exit Warning may not operate properly if interfered by strong electromagnetic waves.
- Safe Exit Warning may not operate for 3 seconds after the vehicle is started, or rear corner radars are initialized.

## MANUAL SPEED LIMIT ASSIST (MSLA)

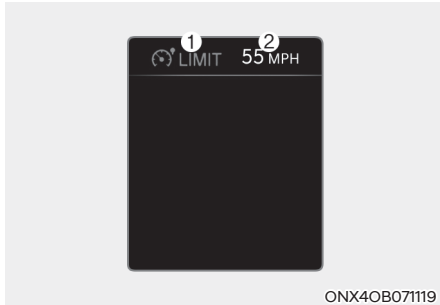

ONX40B071119

(1) Manual Speed Limit Assist enabled indicator

(2) Set speed

You can set the speed limit when you do not want to drive over a specific speed.



If you drive over the preset speed limit, Manual Speed Limit Assist operates (set speed limit will blink and chime will sound) until the vehicle speed returns within the speed limit.

### Manual Speed Limit Assist Operation

#### To set speed limit



ONX4070032

1. Press and hold Driving Assist () button at the desired speed. The Manual Speed Limit Assist enabled () indicator will illuminate on the cluster.

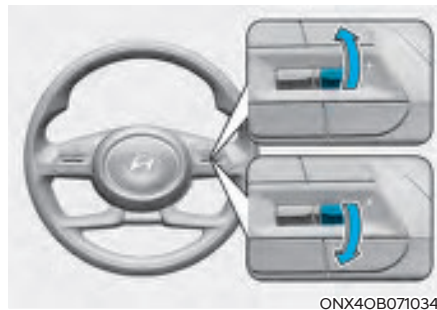

ONX40B071034

2. Push the + switch up or - switch down, and release it at the desired speed. Push the + switch up or - switch down and hold it. The speed will increase or decrease to the nearest multiple of five (multiple of ten in km/h) at first, and then increase or decrease by 5 mph (10 km/h).

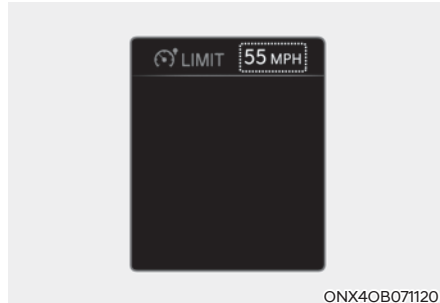

ONX4OB071120

3. The set speed limit is displayed on the cluster.

If you would like to drive over the preset speed limit, depress the accelerator pedal beyond the pressure point to activate the kickdown mechanism.

The set speed limit will blink and chime will sound until you return the vehicle speed within the speed limit.

### **i** Information

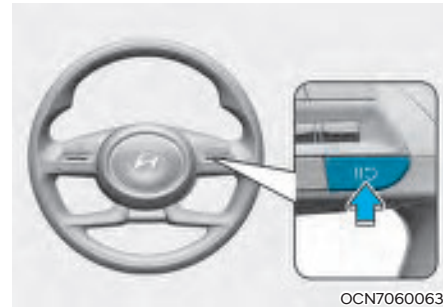

- **When the accelerator pedal is not depressed beyond the pressure point, vehicle speed will maintain within the speed limit.**
- **A clicking sound may be heard from the kickdown mechanism when the accelerator pedal is depressed beyond the pressure point.**

### **To temporarily pause Manual Speed Limit Assist**



OCN7060063

[A] : Type A, [B] : Type B

Push the  switch to temporarily pause the set speed limit. The set speed limit will turn off but the Manual Speed Limit Assist enabled () indicator will stay on.

**To resume Manual Speed Limit Assist**

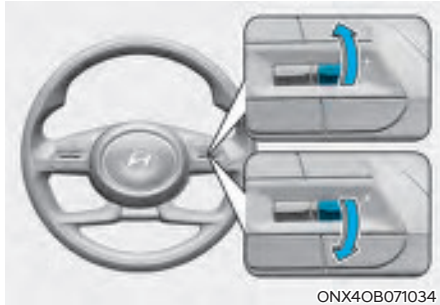

To resume Manual Speed Limit Assist after the function was paused, push the +, -, II (set) switch.

If you push the + switch up or - switch down, vehicle speed will be set to the current speed on the cluster.

If you push the II (set) switch, vehicle speed will resume to the preset speed.

**To turn off Manual Speed Limit Assist**



Press the Driving Assist (car icon) button to turn Manual Speed Limit Assist off. The Manual Speed Limit Assist enabled (LIMIT) indicator will go off.

Always press the Driving Assist (car icon) button to turn Manual Speed Limit Assist off when not in use.

**⚠ WARNING**

Take the following precautions when using Manual Speed Limit Assist:

- Always set the vehicle speed under the speed limit in your country.
- Keep Manual Speed Limit Assist off when the function is not in use, to avoid inadvertently setting a speed. Check that the Manual Speed Limit Assist enabled (LIMIT) indicator is off.
- Manual Speed Limit Assist does not substitute for proper and safe driving. It is the responsibility of the driver to always drive safely and should always be aware of unexpected and sudden situations from occurring. Pay attention to the road conditions at all times.

## INTELLIGENT SPEED LIMIT ASSIST (ISLA) (IF EQUIPPED)

Intelligent Speed Limit Assist uses information from the speed limit signs along the roadway as well as speed limit information in the navigation system to inform the driver and display the speed limit information in the LCD cluster.

On some models, the system works with Smart Cruise Control and can adjust your SET speed based on the speed limit information and user settings.



### CAUTION

- Intelligent Speed Limit Assist may not operate properly if the function is used in other countries.
- If a navigation is applied to your vehicle, the navigation needs to be regularly updated for Intelligent Speed Limit Assist to operate properly.

### Detecting sensor



[1] : Front view camera

Refer to the picture above for the detailed location of the detecting sensor.



### CAUTION

For more details on the precautions of the front view camera, refer to “Forward Collision-Avoidance Assist (FCA)” section in chapter 7.

### Information

If the navigation system is available, the information from the navigation system is used along with the road sign information detected by the front view camera.

### Intelligent Speed Limit Assist Settings

#### Setting features

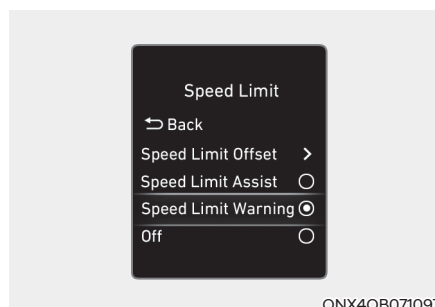

#### Speed limit

With the engine on, select or deselect ‘Driver Assistance → Speed Limit’ from the Settings menu to set whether to use each function.

- If ‘Speed Limit Assist’ is selected, Intelligent Speed Limit Assist informs the driver of speed limit. In addition, Intelligent Speed Limit Assist informs the driver to change set speed of Manual Speed Limit Assist or Smart Cruise Control to help the driver stay within the speed limit.
- If ‘Speed Limit Warning’ is selected, Intelligent Speed Limit Assist informs the driver of speed limit. In addition, Intelligent Speed Limit Assist warns the driver when the vehicle is driven faster than the speed limit.
- If ‘Off’ is selected, Intelligent Speed Limit Assist turns off.



### CAUTION

If ‘Speed Limit Warning’ is selected, Intelligent Speed Limit Assist will not inform the driver to adjust set speed.



### Speed Limit Offset

With the engine on, when 'Driver Assistance → Speed Limit → Speed Limit Offset' is selected, the Speed Limit Offset can be changed. Speed Limit Warning and Speed Limit Assist will operate by applying the Speed Limit Offset setting to the detected speed limit.

### WARNING

- For your safety, change the Settings after parking the vehicle at a safe location.
- Speed Limit Assist function operates based on the Offset setting added to the speed limit. If you want to change the set speed according to the speed limit, adjust the offset to '0'.
- Speed Limit Warning function warns the driver when driving speed exceeds the speed at which the set Offset is added to speed limit. If you want Speed Limit Warning to warn you immediately when the driving speed exceeds the speed limit, adjust the offset to '0'.

### Information

The setting of 'Speed Offset' is not reflected in Navigation-based Smart Cruise Control (NSCC).

## Intelligent Speed Limit Assist Operation

### Warning and control

Intelligent Speed Limit Assist will warn and control the vehicle by 'Displaying speed limit', 'Warning overspeed' and 'Changing set speed'.

### Information

Intelligent Speed Limit Assist warning and control are described based on the Offset adjusted to '0'. For details on Offset setting, refer to the "Intelligent Speed Limit Assist Settings".

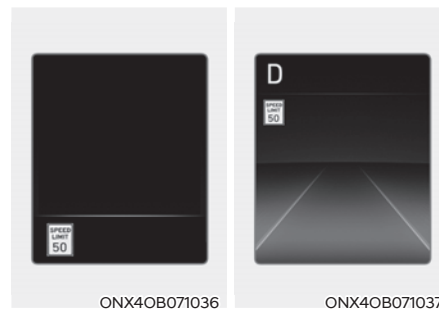

### Displaying speed limit

Speed limit information is displayed on the instrument cluster.

### Information

- If speed limit information of the road cannot be recognized, '---' sign will be displayed. Please refer to "Limitations of Intelligent Speed Limit Assist" if the road signs are difficult to recognize.
- Supplementary sign displayed under the speed limit or overtaking restriction sign means the conditions under which the signs must be followed. If the supplementary sign is not recognized, it will be displayed as blank.
- The images and colors in the cluster may differ depending on the cluster type or theme selected from the cluster.





ONX4OB071036

### Warning overspeed

When driving at a speed higher than the displayed speed limit, the red speed limit indicator blinks.



ONX4OB071038

ONX4OB071039

### Changing set speed

If the speed limit of the road changes during the operation of Manual Speed Limit Assist or Smart Cruise Control, an arrow in the direction of up or down is displayed to inform the driver that the set speed needs to be changed. At this time, the driver can change the set speed according to the speed limit by using the + or - switch on the steering wheel.

### WARNING

- If the Offset is adjusted over '0', the set speed will change to a higher speed than the speed limit of the road. If you want to drive below the speed limit, adjust the Offset under '0' or use the - switch on the steering wheel to lower the set speed.
- Even after changing the set speed according to the speed limit of the road, the vehicle can still be driven over the speed limit. If necessary, depress the brake pedal to reduce your driving speed.
- If the speed limit of the road is under 20 mph (30 km/h), the set speed change function will not work.
- Intelligent Speed Limit Assist operates using the speed unit in the instrument cluster set by the driver. If the speed unit is set to a unit other than the speed unit used in your country, Intelligent Speed Limit Assist may not operate properly.

### Information

- For more details on Manual Speed Limit Assist operation, refer to “Manual Speed Limit Assist (MSLA)” section in chapter 7.
- For more details on Smart Cruise Control operation, refer to “Smart Cruise Control (SCC)” section in chapter 7.

## Intelligent Speed Limit Assist Malfunction and Limitations

### Intelligent Speed Limit Assist malfunction



When Intelligent Speed Limit Assist is not working properly, the 'Check Speed Limit system' warning message appears on the cluster for several seconds, and the master (⚠) warning light illuminates on the cluster. If this occurs, have the vehicle inspected by an authorized HYUNDAI dealer.

### Intelligent Speed Limit Assist disabled

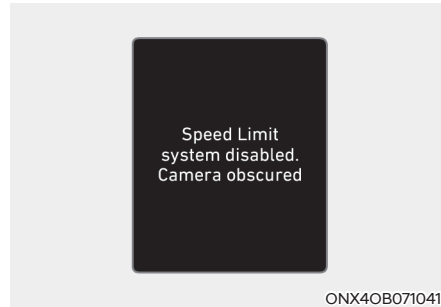

When the front windshield where the front view camera is located is covered with foreign material, such as snow or rain, it can reduce the detecting performance and temporarily limit or disable Intelligent Speed Limit Assist. If this occurs, the 'Speed limit system disabled. Camera obscured' warning message appears on the cluster.

Intelligent Speed Limit Assist will operate properly when snow, rain or foreign material is removed.

If Intelligent Speed Limit Assist does not operate properly after it is removed, have the vehicle inspected by an authorized HYUNDAI dealer.

#### **WARNING**

**Even though the warning message or warning light does not appear on the cluster, Intelligent Speed Limit Assist may not operate properly due to limitations of the function.**

### **Limitations of Intelligent Speed Limit Assist**

Intelligent Speed Limit Assist may not operate or may not provide correct information under the following circumstances:

- The road sign is contaminated or indistinguishable
  - The road sign is difficult to see due to bad weather, such as rain, snow, fog, etc.
  - The road sign is not clear or damaged
  - The road sign is partially obscured by surrounding objects or shadow
- The road signs do not conform to the standard
  - The text or picture on the road sign is different from the standard
  - The road sign is installed between the main line and the exit road or between diverging roads
  - There is no conditional road signs on the road sign located on the exit road
  - A sign is attached to another vehicle
- The distance between the vehicle and the road signs is too far
- The vehicle encounters illuminant road signs
- Intelligent Speed Limit Assist incorrectly recognizes numbers or pictures in the street signs or other signs as the speed limit
- A road sign near the road you are driving is detected
- Multiple signs are installed close together
- The minimum speed limit sign is misrecognized
- The minimum speed limit sign is on the road
- The brightness changes suddenly, for example when entering or exiting a tunnel or passing under a bridge
- Headlamps are not used or the brightness of the headlamps are weak at night or in the tunnel
- Road signs are difficult to recognize due to the reflection of sunlight, street lights, or oncoming vehicles
- The navigation information or GPS information contain errors
- The driver does not follow the guide of the navigation
- The driver is driving on a new road that is not in the navigation system yet
- The field of view of the front view camera is obstructed by sun glare
- Driving on a road that is sharply curved or continuously curved
- Driving through speed bumps, or driving up and down or left to right on steep inclines
- The vehicle is shaking heavily
- Driving on a newly opened road

#### **Information**

For more details on the limitations of the front view camera, refer to “Forward Collision-Avoidance Assist (FCA)” section in chapter 7.

#### **WARNING**

- **Intelligent Speed Limit Assist is a supplemental function that helps the driver to comply with the speed limit on the road, and may not display the correct speed limit or control the driving speed properly.**
- **Always set the vehicle speed under the speed limit in your country.**

## DRIVER ATTENTION WARNING (DAW)

### Basic function

Driver Attention Warning can help determine the driver's attention level by analyzing driving pattern and driving time while the vehicle is driven. Driver Attention Warning will recommend a break when the driver's attention level falls below a certain level.

### Leading Vehicle Departure Alert function

Leading Vehicle Departure Alert function will inform the driver when a detected vehicle in front departs from a stop.

### Detecting sensor



[1] : Front view camera

The front view camera is used to help detect driving patterns and front vehicle departure while vehicle is being driven. Refer to the picture above for the detailed location of the detecting sensor.



### CAUTION

- Always keep the front view camera in good condition to maintain optimal performance of Driver Attention Warning.
- For more details on the precautions of the front view camera, refer to “Forward Collision-Avoidance Assist (FCA)” section in chapter 7.

## Driver Attention Warning Settings

### Setting features

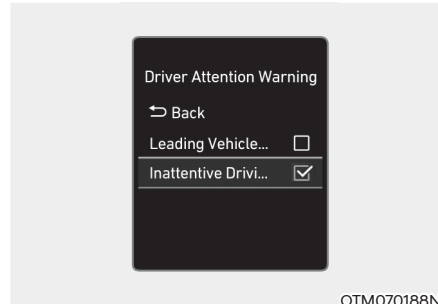

### Driver Attention Warning

With the engine on, select 'Driver Assistance → Driver Attention Warning' from the Settings menu to set whether to use each function.

- If 'Inattentive Driving Warning' is selected, Driver Attention Warning informs the driver of the driver's attention level and will recommend taking a break when the level falls below a certain level.

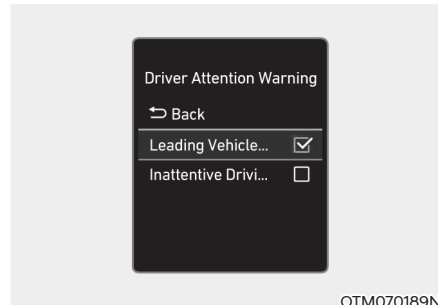

### Leading Vehicle Departure Alert

- If 'Leading Vehicle Departure Alert' is selected, the function informs the driver when a detected vehicle in front departs from a stop.



### Warning Timing

With the engine on, select 'Driver Assistance → Warning Timing' from the Settings menu to change the initial warning activation time for Driver Attention Warning.

When the vehicle is first delivered, Warning Timing is set to 'Normal'. If you change the Warning Timing, the Warning Timing of other Driver Assistance systems may change.

### **i** Information

If the engine is restarted, Driver Attention Warning will maintain the last setting.

## Driver Attention Warning Operation

### Basic function

#### Display and warning

The basic function of Driver Attention Warning is to inform the driver of their 'Attention Level' and to warn the driver to 'Consider taking a break'.

### Attention Level

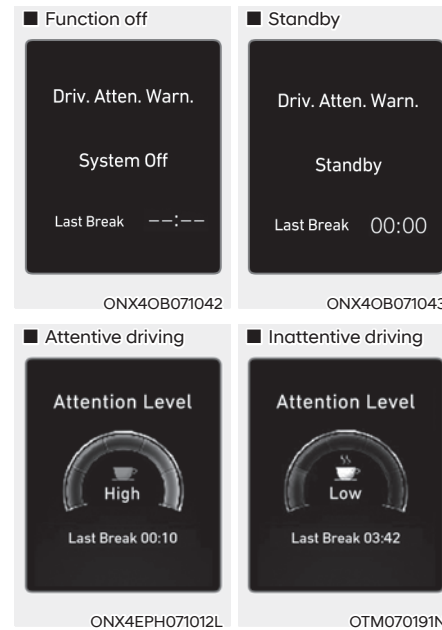

- The driver can monitor his/her driving conditions on the cluster.
  - When the 'Inattentive Driving Warning' is deselected from the Settings menu, 'System Off' is displayed.
  - Driver Attention Warning will operate when vehicle speed is between 0-110 mph (0-180 km/h).
  - When vehicle speed is not within the operating speed, the message 'Standby' will be displayed.

- The driver's attention level is displayed on the scale of 1 to 5. The lower the level is, the more inattentive the driver is.
- The level decreases when the driver does not take a break for a certain period of time.

### Taking a break

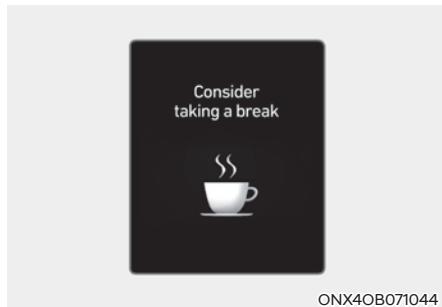

- The 'Consider taking a break' message appears on the cluster and an audible warning sounds to suggest that the driver take a break, when the driver's attention level is below 1.
- Driver Attention Warning will not suggest a break when the total driving time is shorter than 10 minutes or 10 minutes has not passed after the last break was suggested.

### **WARNING**

**For your safety, change the Settings after parking the vehicle at a safe location.**

### **CAUTION**

- **Driver Attention Warning may suggest a break depending on the driver's driving pattern or habits, even if the driver doesn't feel fatigued.**
- **Driver Attention Warning is a supplemental function and may not be able to determine whether the driver is inattentive.**
- **The driver who feels fatigued should take a break at a safe location, even though there is no break suggestion by Driver Attention Warning.**

### **Information**

- **You may change settings from the instrument cluster (User Settings) or infotainment system (Vehicle Settings), whichever option that is provided with your vehicle. For more details, see "User Settings" section in chapter 4, or "Vehicle Settings" section in supplied Infotainment Manual.**
- **Driver Attention Warning resets in the following situations:**
  - **The engine is turned off**
  - **The driver unfastens the seat belt and opens the driver's door**
  - **The vehicle is stopped for more than 10 minutes**

### Leading Vehicle Departure Alert function

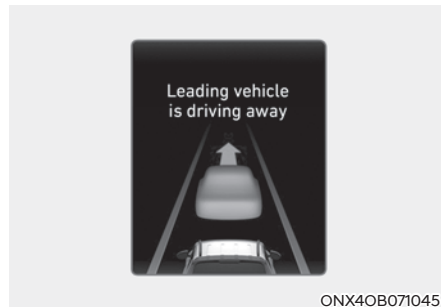

ONX4OB071045

When a detected vehicle in front departs from a stop, Leading Vehicle Departure Alert will inform the driver by displaying the 'Leading vehicle is driving away' message on the cluster and an audible warning will sound.

#### WARNING

- If any other system's warning message is displayed or audible warning is generated, Leading Vehicle Departure Alert's warning message may not be displayed and audible warning may not be generated.
- The driver should hold the responsibility to safely drive and control the vehicle.

#### CAUTION

- Leading Vehicle Departure Alert is a supplemental function and may not alert the driver whenever the front vehicle departs from a stop.
- Always check the front of the vehicle and road conditions before departure.

#### Information

The images and colors in the cluster may differ depending on the cluster type or theme selected from the cluster.

### Driver Attention Warning Malfunction and Limitations

#### Driver Attention Warning malfunction

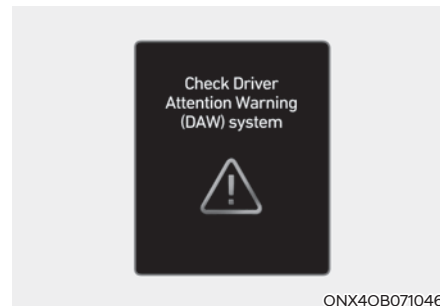

ONX4OB071046

When Driver Attention Warning is not working properly, the 'Check Driver Attention Warning (DAW) system' warning message appears on the cluster for several seconds, and the master () warning light illuminates on the cluster. If this occurs, have the vehicle inspected by an authorized HYUNDAI dealer.

#### Limitations of Driver Attention Warning

Driver Attention Warning may not work properly in the following situations:

- The vehicle is driven violently
- The vehicle intentionally crosses over lanes frequently
- The vehicle is controlled by Driver Assistance system, such as Lane Keeping Assist

**Leading Vehicle Departure Alert feature**

- When the vehicle cuts in

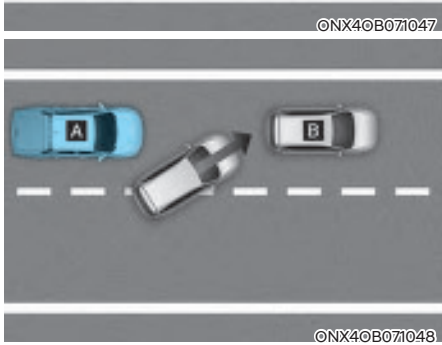
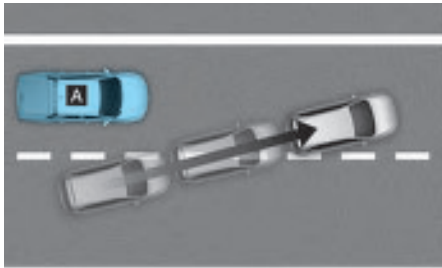

[A] : Your vehicle, [B] : Front vehicle

If a vehicle cuts in front of your vehicle, Leading Departure Alert may not operate properly.

- When the vehicle ahead sharply steers

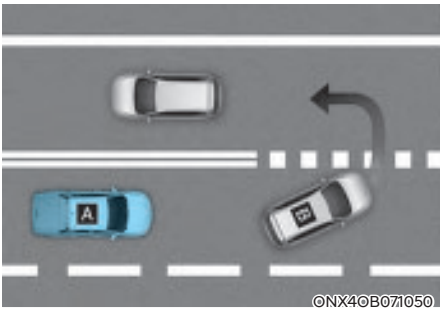

[A] : Your vehicle, [B] : Front vehicle

If the vehicle in front makes a sharp turn, such as to turn left or right or make a U-turn, etc., Leading Vehicle Departure Alert may not operate properly.

- When the vehicle ahead abruptly departs

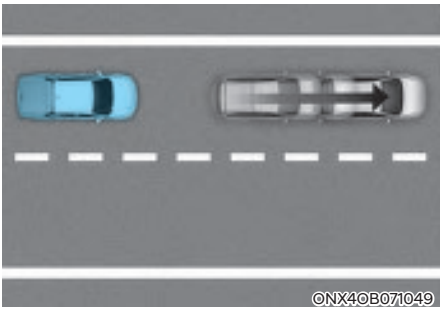

If the vehicle in front abruptly departs, Leading Vehicle Departure Alert may not operate properly.



- When a pedestrian or bicycle is between you and the vehicle ahead

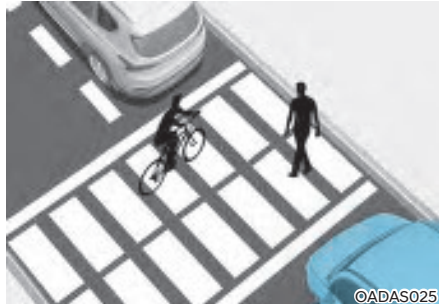

If there is a pedestrian(s) or bicycle(s) in between you and the vehicle in front, Leading Vehicle Departure Alert may not operate properly.

- When in a parking lot



If a vehicle parked in front drives away from you, Leading Vehicle Departure Alert may alert you that the parked vehicle is driving away.

- When driving at a tollgate or intersection, etc.

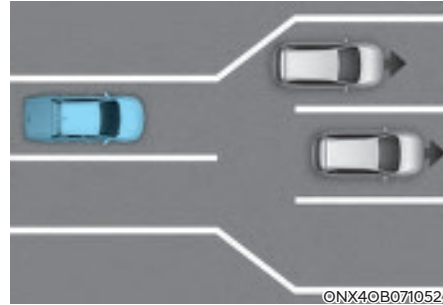

If you pass a tollgate or intersection with lots of vehicles or you drive where lanes are merged or divided frequently, Leading Vehicle Departure Alert may not operate properly.

### **i** Information

For more details on the precautions of the front view camera, refer to “Forward Collision-Avoidance Assist (FCA)” section in chapter 7.

## BLIND-SPOT VIEW MONITOR (BVM) (IF EQUIPPED)

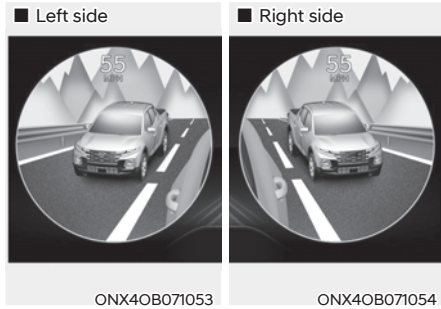

Blind-Spot View Monitor displays the rear blind spot area of the vehicle in the cluster when the turn signal is turned on to help change lanes.

### Detecting sensor



[1], [2] : Surround-side view camera  
(camera located at bottom of the mirror)

Refer to the picture above for the detailed location of the detecting sensors.

### Blind-Spot View Monitor Settings

#### Setting features

##### Blind-Spot View

With the engine on, select 'Driver Assistance → Blind-Spot Safety → Blind-Spot View' from the Settings menu to turn on Blind-Spot View Monitor and deselect to turn off the function.

### Blind-Spot View Monitor Operation

#### Operating switch

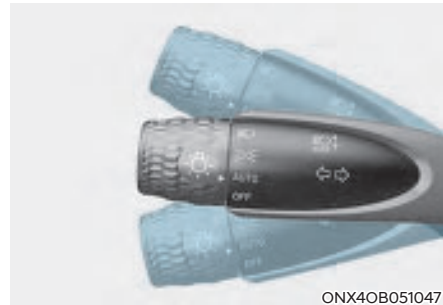

##### Turn Signal switch

Blind-Spot View Monitor turns on and off when the turn signal is turned on and off.

### **Blind-Spot View Monitor**

#### **Operating conditions**

When the left or right side turn signal turns on, the image in that direction is displayed on the instrument cluster.

#### **Off conditions**

- When the turn signal turns off, the image on the instrument cluster will turn off.
- When the hazard warning flasher is on, Blind-Spot View Monitor will turn off, regardless of the turn signal status.
- When other important warning is displayed on the instrument cluster, Blind-Spot View Monitor may turn off.

### **Blind-Spot View Monitor Malfunction**

When Blind-Spot View Monitor is not working properly, or the cluster display flickers, or the camera image does not display properly, have the vehicle inspected by an authorized HYUNDAI dealer.



#### **WARNING**

- **The image shown on the cluster may differ from the actual distance of the object. Make sure to directly check the vehicle's surroundings for safety.**
- **Always keep the camera lens clean. If the lens is covered with foreign material, it may adversely affect camera performance and Blind-Spot View Monitor may not operate properly.**

## CRUISE CONTROL (CC) (IF EQUIPPED)

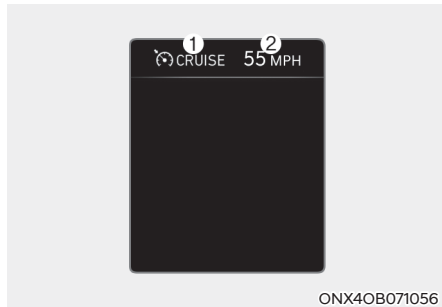

ONX40B071056

- (1) Cruise indicator
- (2) Set speed

Cruise Control allows you to drive at speeds above 20 mph (30 km/h) without depressing the accelerator pedal.



### Cruise Control Operation

#### Setting set speed

1. Accelerate to the desired speed, which must be more than 20 mph (30 km/h).



ONX4070032

2. Press the Driving Assist () button at the desired speed. The set speed and Cruise () indicator will illuminate on the cluster.
3. Release the accelerator pedal.  
Vehicle speed will maintain the set speed even when the accelerator pedal is not depressed.

#### Information

**On a steep slope, the vehicle may slightly slow down or speed up while driving uphill or downhill.**

**Increasing set speed**

- Push the + switch up and release it immediately. The set speed will increase by 1 mph (1 km/h) each time the switch is operated in this manner.
- Push the + switch up and hold it while monitoring the set speed on the cluster. The set speed will increase to the nearest multiple of five in mph (multiple of ten) at first, and then increase by 5 mph (10 km/h) each time the switch is operated in this manner.

Release the switch when the desired speed is shown and the vehicle will accelerate to that speed.

**Decreasing set speed**

- Push the - switch down and release it immediately. The set speed will decrease by 1 mph (1 km/h) each time the switch is operated in this manner.
- Push the - switch down and hold it while monitoring the set speed on the cluster. The set speed will decrease to the nearest multiple of five in mph (multiple of ten) at first, and then decrease by 5 mph (10 km/h) each time the switch is operated in this manner.

Release the switch at the speed you want to maintain.

**Accelerating temporarily**

If you want to speed up temporarily when Cruise Control is on, depress the accelerator pedal.

To return to the set speed, take your foot off the accelerator pedal.

If you push the + switch up or - switch down at increased speed, the set speed will be set to the current increased speed.

### Temporarily pausing Cruise Control

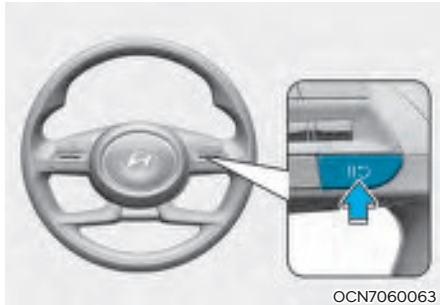

Cruise Control pauses when:

- Depressing the brake pedal.
- Pushing the  button.
- Shifting the gear to N (Neutral).
- Decreasing vehicle speed to less than approximately 20 mph (30 km/h).
- ESC (Electronic Stability Control) is operating.
- Downshifting to 2nd gear when in Manual Shift mode.

The set speed will turn off but the Cruise (CRUISE) indicator will stay on.

#### **NOTICE**

**If Cruise Control pauses during a situation that is not mentioned, have the vehicle inspected by an authorized HYUNDAI dealer.**

### Resuming Cruise Control

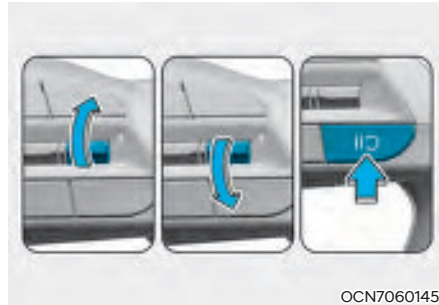



Push the +, - switch or  button.

If you push the + switch up or - switch down, vehicle speed will be set to the current speed on the cluster.

If you push the  button, vehicle speed will resume to the preset speed. Vehicle speed must be above 20 mph (30 km/h) for the function to resume.



#### **WARNING**

**Check the driving condition before using the  button. Driving speed may sharply increase or decrease when you press the  button.**

### Turning off Cruise Control

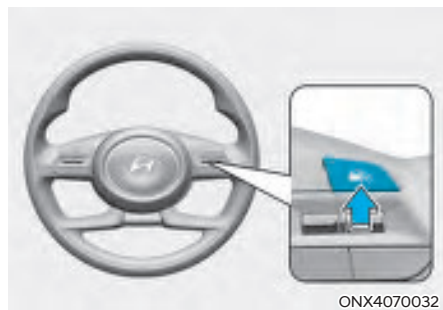

Press the Driving Assist (🚗) button to turn Cruise Control off. The Cruise (CRUISE) indicator will go off.

Always press the Driving Assist (🚗) button to turn Cruise Control off when not in use.

### **i** Information

If your vehicle is equipped with Manual Speed Limit Assist, press and hold the Driving Assist button to turn off Cruise Control. However, Manual Speed Limit Assist will turn on.

### **⚠** WARNING

Take the following precautions when using Cruise Control:

- Always set the vehicle speed to the speed limit in your country.
- Keep Cruise Control off when the function is not in use, to avoid inadvertently setting a speed. Check that the Cruise (CRUISE) indicator is off.
- Cruise Control does not substitute for proper and safe driving. It is the responsibility of the driver to always drive safely and should always be aware of unexpected and sudden situations from occurring.
- Always drive cautiously to prevent unexpected and sudden situations from occurring. Pay attention to the road conditions at all times.
- Do not use Cruise Control when it may be unsafe to keep the vehicle at a constant speed:
  - When driving in heavy traffic, or when traffic conditions make it difficult to drive at a constant speed
  - When driving on rainy, icy, or snow-covered roads
  - When driving on hilly or windy roads
  - When driving in windy areas
  - When driving with limited view (possibly due to bad weather, such as fog, snow, rain and sandstorm)
- Do not use Cruise Control when towing a trailer.

## SMART CRUISE CONTROL (SCC) (IF EQUIPPED)

### Basic function

Smart Cruise Control is designed to help detect the vehicle ahead and help maintain the desired speed and minimum distance between the vehicle ahead.

### Overtaking Acceleration Assist

While Smart Cruise Control is operating, if the function judges that the driver is determined to overtake the vehicle in front, acceleration will be assisted.

### Detecting sensor



[1] : Front view camera,

[2] : Front radar

The front view camera and front radar are used as a detecting sensor to help detect vehicles in front.

Refer to the picture above for the detailed location of the detecting sensor.



### CAUTION

- Always keep the front view camera and front radar in good condition to maintain optimal performance of Smart Cruise Control.
- For more details on the precautions of the front view camera and front radar, refer to “Forward Collision-Avoidance Assist (FCA)” section in chapter 7.



## Smart Cruise Control Settings

### Setting features

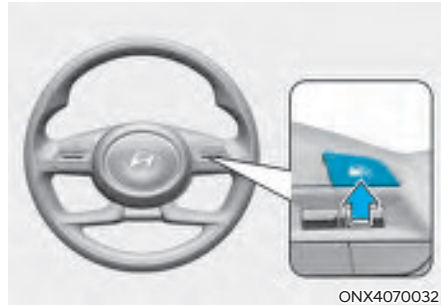

#### Turning on Smart Cruise Control

- Press the Driving Assist (🚗) button to turn on Smart Cruise Control. The speed will be set to the current speed on the cluster.
- If there is no vehicle in front of you, the set speed will be maintained, but if there is a vehicle in front of you, the speed may decrease to maintain the distance to the vehicle ahead. If the vehicle ahead accelerates, your vehicle will travel at a steady cruising speed after accelerating to the set speed.

#### **i** Information

- If your vehicle speed is between 0-20 mph (0-30 km/h) when you press the Driving Assist button, the Smart Cruise Control speed will be set to 20 mph (30 km/h).
- The Driving Assist button symbol may vary depending on your vehicle option.

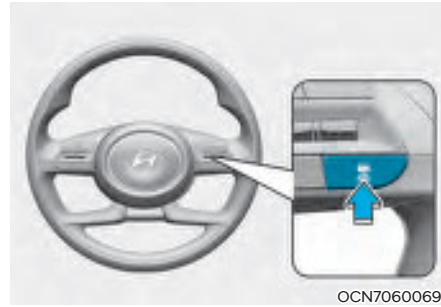

#### Setting vehicle distance

Each time the button is pressed, the vehicle distance changes as follows:

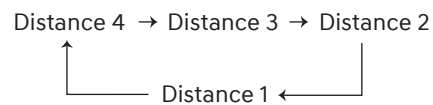

#### **i** Information

- If you drive at 56 mph (90 km/h), the distance is maintained as follows:
  - Distance 4 - approximately 172 ft. (53 m)
  - Distance 3 - approximately 130 ft. (40m)
  - Distance 2 - approximately 106 ft. (30m)
  - Distance 1 - approximately 82 ft. (25m)
- The distance is set to the last set distance when the engine is restarted, or when Smart Cruise Control was temporarily canceled.

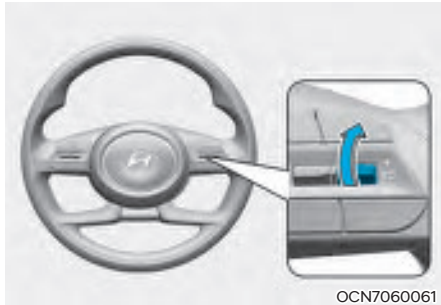

#### Increasing set speed

- Push the + switch up and release it immediately. The set speed will increase by 1 mph (1 km/h) each time the switch is operated in this manner.
- Push the + switch up and hold it while monitoring the set speed on the cluster. The set speed will increase by 5 mph or 10 km/h each time the switch is operated in this manner. Release the switch when the desired speed is shown, and the vehicle will accelerate to that speed. You can set the speed to 110 mph (100 km/h).



#### Decreasing set speed

- Push the - switch down and release it immediately. The set speed will decrease by 1 mph (1 km/h) each time the switch is operated in this manner.
- Push the - switch down and hold it while monitoring the set speed on the cluster. The set speed will decrease by 5 mph or 10 km/h each time the switch is operated in this manner. Release the switch at the speed you want to maintain. You can set the speed to 20 mph (30 km/h).



#### **WARNING**

**Check the driving condition before using the + switch. Driving speed may sharply increase when you push up and hold the + switch.**

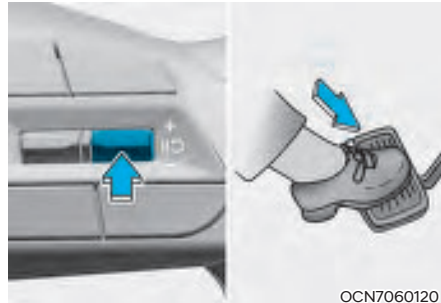

OCN7060120

#### Temporarily canceling Smart Cruise Control

Press the  switch or depress the brake pedal to temporarily cancel Smart Cruise Control.



OCN7060121



#### Resuming Smart Cruise Control

To resume Smart Cruise Control after the function was canceled, push the +, - or  switch.

If you push the + switch up or - switch down, vehicle speed will be set to the current speed on the cluster.

If you push the  switch, vehicle speed will resume to the preset speed.

#### WARNING

Check the driving condition before using the  switch. Driving speed may sharply increase or decrease when you press the  switch.



ONX4070032

#### Turning off Smart Cruise Control

Press the Driving Assist () button to turn Smart Cruise Control off.

#### Information

If your vehicle is equipped with Manual Speed Limit Assist, press and hold the Driving Assist button to turn off Smart Cruise Control. However, Manual Speed Limit Assist will turn on.

### Based on Drive Mode

Smart Cruise Control will change acceleration based on the drive mode selected from Drive Mode Integrated Control system. Refer to the following chart.

Drive mode	Smart Cruise Control
NORMAL	Normal
SPORT	Fast
SMART	Normal
SNOW (if equipped)	Slow

### **i** Information

- For more details on drive mode, refer to “Drive Mode Integrated Control System” section in chapter 6.
- Smart Cruise Control may not turn on or off in some of the drive modes for the operating conditions are not satisfied.
- If your vehicle is not equipped with Drive Mode Integrated Control system, Smart Cruise Control accelerates your vehicle at a normal level.

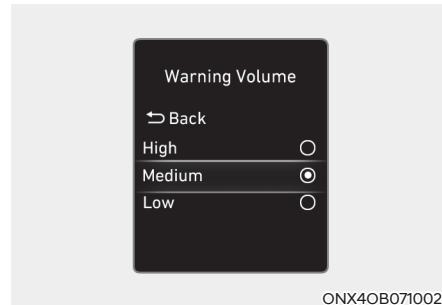

### Warning Volume

With the engine on, select ‘Driver Assistance → Warning Volume’ from the Settings menu to change the Warning Volume to ‘High’, ‘Medium’ or ‘Low’ for Smart Cruise Control.

If you change the Warning Volume, the Warning Volume of other Driver Assistance systems may change.

### **i** Information

**If the engine is restarted, Warning Volume will maintain the last setting.**

## Smart Cruise Control Operation

### Operating conditions

Smart Cruise Control operates when the following conditions are satisfied.

#### Basic function

- The gear is in D (Drive)
- The driver's door is closed
- EPB (Electronic Parking Brake) is not applied
- Your vehicle speed is within the operating speed range
  - 5-110 mph (10-180 km/h): when there is no vehicle in front
  - 0-110 mph (0-180 km/h): when there is a vehicle in front
- ESC (Electronic Stability Control) or ABS is on
- ESC (Electronic Stability Control) or ABS is not controlling the vehicle
- Engine RPM is not in the red zone
- Forward Collision-Avoidance Assist brake control is not operating (if equipped)

#### Information

At a stop, if there is a vehicle in front of your vehicle, Smart Cruise Control turns on when the brake pedal is depressed.

### Overtaking Acceleration Assist (Lane Changing Mode - Overtaking another vehicle while Smart Cruise Control is enabled)

When Smart Cruise Control is enabled and your vehicle is approaching another vehicle in your current lane, if you activate the left turn signal to merge in order to overtake the vehicle, Smart Cruise Control will temporarily disable controlling the approaching distance until you overtake the vehicle.

If this occurs, your vehicle will not decelerate in order to maintain the set following distance with the vehicle in front.

This feature will be applied when the following conditions are met:

- Your vehicle speed is above 40 mph (60 km/h)
- The hazard warning flashers are off
- The feature detects another vehicle in front of your vehicle
- Deceleration is not needed to maintain distance with the vehicle in front

#### WARNING

- **When the turn signal indicator is turned on to the left while there is a vehicle ahead, the vehicle may accelerate temporarily. Pay attention to the road conditions at all times.**
- **Regardless of your countries driving direction, Overtaking Acceleration Assist will operate when the conditions are satisfied. When using the function in countries with different driving direction, always check the road conditions at all times.**

### Display and Control

#### Basic function

You can see the status of the Smart Cruise Control operation in the Driving Assist mode on the cluster. Refer to “LCD Display Modes” section in chapter 4.

Smart Cruise Control is displayed as below depending on the status of the function.



- When operating
  - (1) Whether there is a vehicle ahead and the selected distance level
  - (2) Set speed
  - (3) Whether there is a vehicle ahead and the target vehicle distance



- When temporarily canceled
  - (1) CRUISE indicator
  - (2) The previous set speed is shaded
  - (3) Vehicle ahead and distance level are not displayed

#### **i** Information

- **The distance of the front vehicle on the cluster is displayed according to the actual distance between your vehicle and the vehicle ahead.**
- **The target distance may vary according to the vehicle speed and the set distance level. If the vehicle speed is low, even though the vehicle distance have changed, the change of the target vehicle distance may be small.**
- **The images and colors in the cluster may differ depending on the cluster type or theme selected from the cluster.**

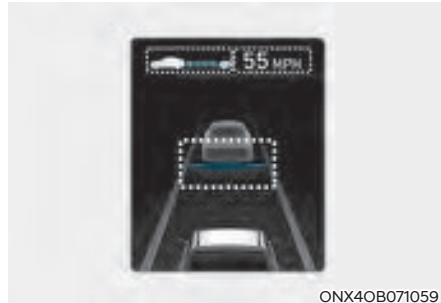

#### Accelerating temporarily

If you want to speed up temporarily without altering the set speed while Smart Cruise Control is operating, depress the accelerator pedal. While the accelerator pedal is depressed, the set speed, distance level and target distance will blink on the cluster.

However, if the accelerator pedal is depressed insufficiently, the vehicle may decelerate.



#### WARNING

**Be careful when accelerating temporarily, because the speed and distance is not controlled automatically even if there is a vehicle in front of you.**



#### Temporarily canceling Smart Cruise Control

Smart Cruise Control will be temporarily canceled automatically when:

- The vehicle speed is above 120 mph (190 km/h)
- The vehicle is stopped for a certain period of time
- The accelerator pedal is continuously depressed for a certain period of time
- The conditions for the Smart Cruise Control to operate is not satisfied

If Smart Cruise Control is temporarily canceled automatically, the 'Smart Cruise Control canceled' warning message appears on the cluster, and an audible warning sounds to warn the driver.

If Smart Cruise Control is temporarily canceled while the vehicle is at a standstill with the function activated, EPB (Electronic Parking Brake) maybe applied.



#### WARNING

**When Smart Cruise Control is temporarily canceled, distance with the front vehicle will not be maintained. Always have your eyes on the road while driving, and if necessary, depress the brake pedal to reduce your driving speed in order to maintain a safe distance.**

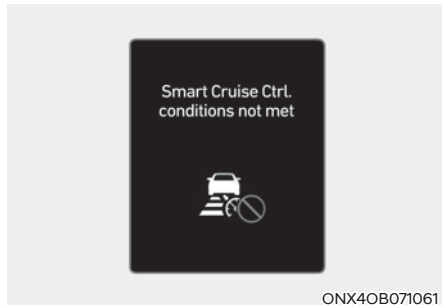

### Smart Cruise Control conditions not satisfied

If the Driving Assist button, + switch, - switch or  switch is pushed when Smart Cruise Control's operating conditions are not satisfied, the 'Smart Cruise Control conditions not met' appears on the cluster, and an audible warning sounds.



### In traffic situation

In traffic, your vehicle will stop if the vehicle ahead of you stops. Also, if the vehicle ahead of you starts moving, your vehicle will start as well. In addition, after the vehicle has stopped and a certain time have passed, the 'Use switch or pedal to accelerate' message appears on the cluster. Depress the accelerator pedal or push the + switch, - switch or  switch to start driving.

### WARNING

**While the message is displayed on the cluster, if there is no vehicle in front or the vehicle is far away from you, and the + switch, - switch or  switch is pushed, Smart Cruise Control will automatically cancel and EPB will be applied. However, if the accelerator pedal is depressed, EPB will not be applied even though the function is canceled. Always pay attention to the road condition ahead.**



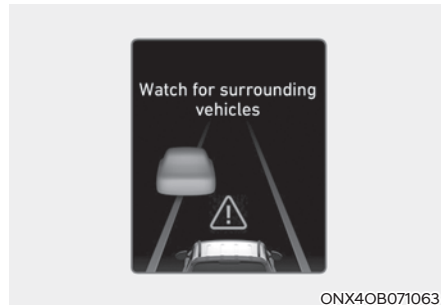

ONX4OB071063

#### Warning road conditions ahead

In the following situation, the 'Watch for surrounding vehicles' warning message appears on the cluster, and an audible warning sounds to warn the driver of road conditions ahead.

- The vehicle in front disappears when Smart Cruise Control is maintaining the distance with the vehicle ahead while driving below a certain speed.
- While the 'Use switch or pedal to accelerate' message is displayed on the cluster, if there is no vehicle in front or the vehicle is far away from you, and the + switch, - switch or II switch is pushed.

#### **WARNING**

Always pay attention to vehicles or objects that may suddenly appear in front of you, and if necessary, depress the brake pedal to reduce your driving speed in order to maintain a safe distance.

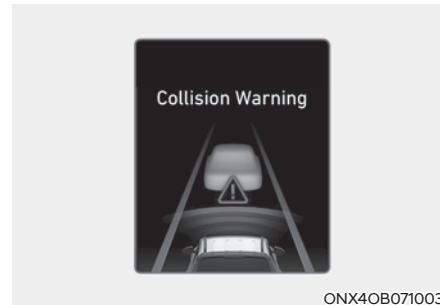

ONX4OB071003

#### Collision Warning

While Smart Cruise Control is operating, when the collision risk with the vehicle ahead is high, the 'Collision Warning' warning message appears on the cluster, and an audible warning sounds to warn the driver. Always have your eyes on the road while driving, and if necessary, depress the brake pedal to reduce your driving speed in order to maintain a safe distance.

#### **WARNING**

In the following situations, Smart Cruise Control may not warn the driver of a collision.

- The distance from the front vehicle is near, or the vehicle speed of the front vehicle is faster or similar with your vehicle
- The speed of the front vehicle is very slow or is at a standstill
- The accelerator pedal is depressed right after Smart Cruise Control is turned on



## WARNING

Take the following precautions when using Smart Cruise Control:

- Smart Cruise Control does not substitute for proper and safe driving. It is the responsibility of the driver to always check the speed and distance to the vehicle ahead.
- Smart Cruise Control may not recognize unexpected and sudden situations or complex driving situations, so always pay attention to driving conditions and control your vehicle speed.
- Keep Smart Cruise Control off when the function is not in use to avoid inadvertently setting a speed.
- Do not open the door or leave the vehicle when Smart Cruise Control is operating, even if the vehicle is stopped.
- Always be aware of the selected speed and vehicle distance.
- Keep a safe distance according to road conditions and vehicle speed. If the vehicle distance is too close during high-speed driving, a serious collision may result.
- When maintaining distance with the vehicle ahead, if the front vehicle disappears, Smart Cruise Control may suddenly accelerate to the set speed. Always be aware of unexpected and sudden situations from occurring.
- Vehicle speed may decrease on an upward slope and increase on a downward slope.
- Always be aware of situations such as when a vehicle cuts in suddenly.
- When you are towing a trailer or another vehicle, we recommend that Smart Cruise Control is turned off due to safety reasons.
- Turn off Smart Cruise Control when your vehicle is being towed.
- Smart Cruise Control may not operate properly if interfered by strong electromagnetic waves.
- Smart Cruise Control may not detect an obstacle in front and lead to a collision. Always look ahead cautiously to prevent unexpected and sudden situations from occurring.
- Vehicles moving in front of you with a frequent lane change may cause a delay in Smart Cruise Control reaction or may cause Smart Cruise Control to react to a vehicle actually in an adjacent lane. Always drive cautiously to prevent unexpected and sudden situations from occurring.
- Always be aware of the surroundings and drive safely, even though a warning message does not appear or an audible warning does not sound.
- If any other system's warning message is displayed or warning sound is generated, Smart Cruise Control warning message may not be displayed and warning sound may not be generated.
- You may not hear the warning sound of Forward Collision-Avoidance Assist if the surrounding is noisy.
- The vehicle manufacturer is not responsible for any traffic violation or accidents caused by the driver.
- Always set the vehicle speed under the speed limit in your country.



## Information

- Smart Cruise Control may not operate for 15 seconds after the vehicle is started or the front view camera or front radar is initialized.
- You may hear a sound when the brake is controlled by Smart Cruise Control.

## Smart Cruise Control Malfunction and Limitations

### Smart Cruise Control malfunction



When Smart Cruise Control is not working properly, the 'Check Smart Cruise Control system' warning message appears, and the  warning light illuminates on the cluster. Have the vehicle inspected by an authorized HYUNDAI dealer.

### Smart Cruise Control disabled

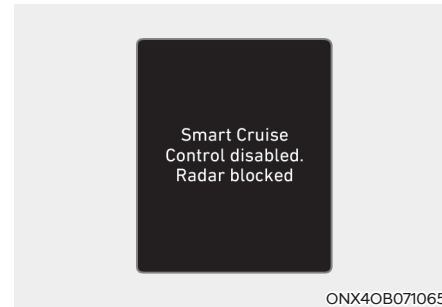

When the front radar cover or sensor is covered with snow, rain, or foreign material, it can reduce the detecting performance and temporarily limit or disable Smart Cruise Control.

If this occurs the 'Smart Cruise Control disabled. Radar blocked' warning message appears for a certain period of time on the cluster.

Smart Cruise Control will operate properly when snow, rain or foreign material is removed.



#### WARNING

Even though the warning message does not appear on the cluster, Smart Cruise Control may not properly operate.



#### CAUTION

Smart Cruise Control may not properly operate in an area (for example, open terrain), where there is nothing to detect after turning ON the engine.

### ***Limitations of Smart Cruise Control***

Smart Cruise Control may not operate properly, or it may operate unexpectedly under the following circumstances:

- The detecting sensor or the surroundings are contaminated or damaged
- Washer fluid is continuously sprayed, or the wiper is on
- The camera lens is contaminated due to tinted, filmed or coated windshield, damaged glass, or sticky foreign material (sticker, bug, etc.) on the glass
- Moisture is not removed or frozen on the windshield
- The field of view of the front view camera is obstructed by sun glare
- Street light or light from an oncoming vehicle is reflected on the wet road surface, such as a puddle on the road
- The temperature around the front view camera is high or low
- An object is placed on the dashboard
- The surrounding is very bright
- The surrounding is very dark, such as in a tunnel, etc.
- The brightness changes suddenly, for example when entering or exiting a tunnel
- The brightness outside is low, and the headlamps are not on or are not bright
- Driving in heavy rain or snow, or thick fog
- Driving through steam, smoke or shadow
- Only part of the vehicle is detected
- The vehicle in front has no tail lights, tail lights are located unusually, etc.
- The brightness outside is low, and the tail lamps are not on or are not bright
- The rear of the front vehicle is small or does not look normal (for example, tilted, overturned, etc.)
- The front vehicle's ground clearance is low or high
- A vehicle suddenly cuts in front
- Your vehicle is being towed
- Driving through a tunnel or iron bridge
- Driving near areas containing metal substances, such as a construction zone, railroad, etc.
- An object reflecting off the front radar such as a guardrail, nearby vehicle, etc.
- The bumper around the front radar is impacted, damaged or the front radar is out of position
- The temperature around the front radar is high or low
- Driving in vast areas where there are few vehicles or structures (for example, desert, meadow, suburb, etc.)
- The vehicle in front is made of material that does not reflect on the front radar
- Driving near a highway interchange or tollgate
- Driving on a slippery surface due to snow, water puddle, ice, etc.
- Driving on a curved road
- The vehicle in front is detected late
- The vehicle in front is suddenly blocked by an obstacle
- The vehicle in front suddenly changes lane or suddenly reduces speed

- The vehicle in front is bent out of shape
- The front vehicle's speed is fast or slow
- With a vehicle in front, your vehicle changes lane at low speed
- The vehicle in front is covered with snow
- Unstable driving
- You are on a roundabout and the vehicle in front is not detected
- You are continuously driving in a circle
- Driving in a parking lot
- Driving through a construction area, unpaved road, partial paved road, uneven road, speed bumps, etc.
- Driving on an incline road, curved road, etc.
- Driving through a roadside with trees or streetlights
- The adverse road conditions cause excessive vehicle vibrations while driving
- Your vehicle height is low or high due to heavy loads, abnormal tire pressure, etc.
- Driving through a narrow road where trees or grass are overgrown
- There is interference by electromagnetic waves, such as driving in an area with strong radio waves or electrical noise

- Driving on a curved road

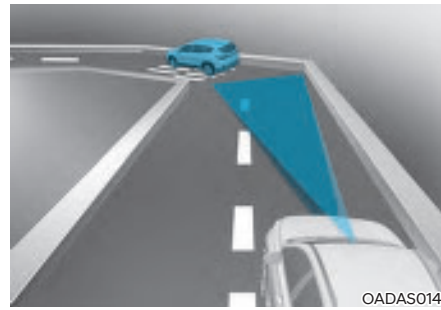

On curves, Smart Cruise Control may not detect a vehicle in the same lane, and may accelerate to the set speed. Also, vehicle speed may rapidly decrease when the vehicle ahead is detected suddenly.

Select the appropriate set speed on curves and apply the brake pedal or accelerator pedal according to the road and driving conditions ahead.



Your vehicle speed can be reduced due to a vehicle in the adjacent lane.

Apply the accelerator pedal and select the appropriate set speed. Check to be sure that the road conditions permit safe operation of the Smart Cruise Control.

- Driving on an inclined road



During uphill or downhill driving, the Smart Cruise Control may not detect a moving vehicle in your lane, and cause your vehicle to accelerate to the set speed. Also, vehicle speed will rapidly decrease when the vehicle ahead is detected suddenly. Select the appropriate set speed on inclines and apply the brake pedal or accelerator pedal according to the road and driving conditions ahead.

- Changing lanes

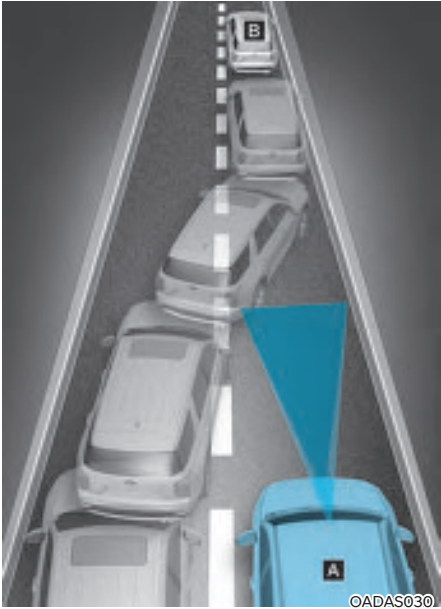

[A] : Your vehicle, [B] : Lane changing vehicle

When a vehicle moves into your lane from an adjacent lane, it cannot be detected by the sensor until it is in the sensor's detection range. Smart Cruise Control may not immediately detect the vehicle when the vehicle changes lanes abruptly. In this case, you must maintain a safe braking distance, and if necessary, depress the brake pedal to reduce your driving speed in order to maintain a safe distance.

- Situations when detecting are limited

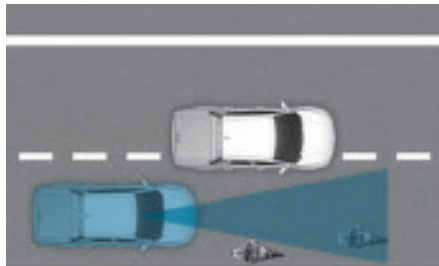

©NX40B071066



©NX40B071012

In the following cases, some vehicles in your lane cannot be detected by the sensor:

- Vehicles offset to one side
- Slow-moving vehicles or sudden-decelerating vehicles
- Vehicles with higher ground clearance or vehicles carrying loads that stick out of the back of the vehicle
- Vehicles that has the front lifted due to heavy loads
- Vehicles within approximately 6 feet (2 m) from your vehicle
- Oncoming vehicles
- Stopped vehicles

- Vehicles with small rear profile, such as trailers
- Narrow vehicles, such as motorcycles or bicycles
- Special vehicles
- Animals and pedestrians

Adjust your vehicle speed by depressing the brake pedal according to the road and driving conditions ahead.

In the following cases, the vehicle in front cannot be detected by the sensor:

- You are steering your vehicle
- Driving on narrow or sharply curved roads

Adjust your vehicle speed by depressing the brake pedal according to the road and driving conditions ahead.

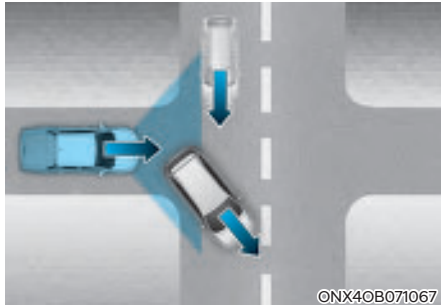

- When a vehicle ahead disappears at an intersection, your vehicle may accelerate.  
Always pay attention to road and driving conditions while driving.

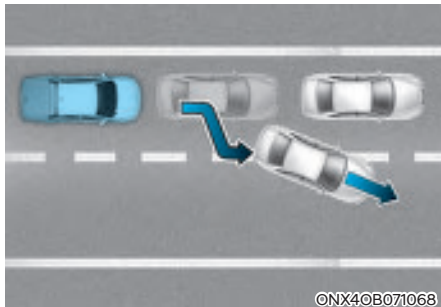

- When a vehicle in front of you merges out of the lane, Smart Cruise Control may not immediately detect the new vehicle that is now in front of you.  
Always pay attention to road and driving conditions while driving.

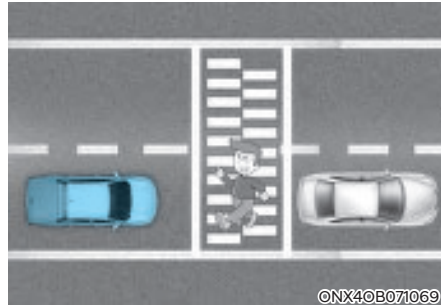

- Always look out for pedestrians when your vehicle is maintaining a distance with the vehicle ahead.

### **i** Information

This device complies with Part 15 of the FCC rules.

Operation is subject to the following three conditions:

1. This device may not cause harmful interference, and
2. This device must accept any interference received, including interference that may cause undesired operation.
3. Changes or modifications not expressly approved by the party responsible for compliance could void the user's authority to operate the device.

### **i** Information

Radio frequency radiation exposure information:

This equipment complies with FCC radiation exposure limits set forth for an uncontrolled environment.

This equipment should be installed and operated with minimum distance of 8 in. (20 cm) between the radiator (antenna) and your body.

This transmitter must not be co-located or operating in conjunction with any other antenna or transmitter.



## NAVIGATION-BASED SMART CRUISE CONTROL (NSCC) (IF EQUIPPED)

Navigation-based Smart Cruise Control uses roadway information that is available on certain highways to automatically adjust your cruise control set speed.

There are two important features that make up the Navigation-based Smart Cruise Control - Highway Auto Speed Change and Highway Auto Curve Slowdown.

### **i** Information

- **Navigation-based Smart Cruise Control is available only on controlled access road of certain highways.**

\* **Controlled access road indicates roads with limited entrances and exits that allow uninterrupted high speed traffic flow. Only passenger cars and motorcycles are allowed on controlled access roads.**

Available highway (Controlled access road)	
USA	Select Interstate Highway and U.S. (Federal) and State Highways
Canada	Select Provincial and Territorial Highways

- **Additional highways may be expanded by future navigation updates.**

### **i** Information

**Navigation-based Smart Cruise Control operates on main roads of highways, and does not operate on interchanges or junctions.**

### **Highway Auto Curve Slowdown**

If vehicle speed is high, Highway Auto Curve Slowdown function will temporarily decelerate your vehicle or limit acceleration to help you drive safely on a curve based on the curve information from the navigation.

### **Highway Auto Speed Change**

Highway Auto Speed Change function automatically changes Smart Cruise Control set speed based on the speed limit information from the navigation.

## Navigation-based Smart Cruise Control Settings

### Setting features



With the engine on, select 'Driver Assistance → Driving Convenience → Auto Highway Speed Control' from the Settings menu to turn on Navigation-based Smart Cruise Control and deselect to turn off the function.

### Highway Auto Curve Slowdown

With the engine on, select 'Driver Assistance → Driving Convenience → Highway Auto Curve Slowdown' from the Settings menu to turn on Highway Auto Curve Slowdown and deselect to turn off the function.

### **i** Information

When there is a problem with Navigation-based Smart Cruise Control, the function cannot be set from the Settings menu.

## Navigation-based Smart Cruise Control Operation

### Operating conditions

Navigation-based Smart Cruise Control is ready to operate if all of the following conditions are satisfied:

- Smart Cruise Control is operating
- Driving on main roads of highways

### **i** Information

For more details on how to operate Smart Cruise Control, refer to "Smart Cruise Control (SCC)" section in chapter 7.

### Navigation-based Smart Cruise Control display and control

When Navigation-based Smart Cruise Control operates, it is displayed on the cluster as follows:

- Navigation-based Smart Cruise Control standby



If the operating conditions are satisfied, the white **AUTO** symbol illuminates.

- Navigation-based Smart Cruise Control operating



If temporary deceleration is required in the standby state and Navigation-based Smart Cruise Control is operating, the green **AUTO** symbol illuminates on the cluster.

If the Highway Auto Speed Change function operates, the **AUTO** symbol and set speed illuminates in green on the cluster, and an audible warning sounds.

### WARNING

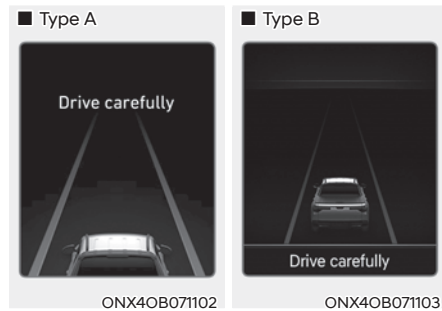

**'Drive carefully' warning message appears in the following circumstances:**

- **Navigation-based Smart Cruise Control is not able to slow down your vehicle to a safe speed**

### Information



**Highway Auto Curve Slowdown and Highway Auto Speed Change function uses the same **AUTO** symbol.**

#### Highway Auto Curve Slowdown

- Depending on the curve ahead on the highway, the vehicle will decelerate, and after passing the curve, the vehicle will accelerate to Smart Cruise Control set speed.
- Vehicle deceleration time may differ depending on the vehicle speed and the degree of the curve on the road. The higher the driving speed, deceleration will start faster.

#### Highway Auto Speed Change

- Highway Auto Speed Change function will operate when Smart Cruise Control set speed and the highway speed limit is matched.
- While Highway Auto Speed Change function is operating, when the highway speed limit changes, Smart Cruise Control set speed automatically changes to the changed speed limit.
- If Smart Cruise Control set speed is adjusted different from the speed limit, Highway Auto Speed Change function will be in the standby state.
- If Highway Auto Speed Change function has changed to the standby state by driving on a road other than the highway main road, Highway Auto Speed Change function will operate again when you drive on the main road again without setting the set speed.

- If Highway Auto Speed Change function has changed to the standby state by depressing the brake pedal or pressing the  switch on the steering wheel, press the  switch to restart the function.
- Highway Auto Speed Change function does not operate on highway interchanges or junctions.

### Information

- **Highway Auto Speed Change function only operates based on the speed limits of the highway, it does not work with speed cameras.**
- **When Highway Auto Speed Change function is operating, the vehicle automatically accelerates or decelerates when the highway speed limit changes.**
- **The maximum set speed for Highway Auto Speed Change function is 86 mph (140 km/h).**
- **If the speed limit of a new road is not updated in the navigation, Highway Auto Speed Change function may not operate properly.**
- **If the speed unit is set to a unit other than the speed unit used in your country, Highway Auto Speed Change function may not operate properly.**

### Limitations of Navigation-based Smart Cruise Control

Navigation-based Smart Cruise Control may not operate properly under the following circumstances:

- The navigation is not working properly
- Map information is not transmitted due to infotainment system's abnormal operation
- Speed limit and road information in the navigation is not updated
- The map information and the actual road is different because of real-time GPS data or map information error
- The navigation searches for a route while driving
- GPS signals are blocked in areas such as a tunnel
- A road that divides into two or more roads and joins again
- The driver goes off course the route set in the navigation
- The route to the destination is changed or canceled by resetting the navigation
- The vehicle enters a service station or rest area
- Android Auto or Car Play is operating
- The navigation cannot detect the current vehicle position (for example, elevated roads including overpass adjacent to general roads or nearby roads exist in a parallel way)
- The navigation is being updated while driving
- The navigation is being restarted while driving
- The speed limit of some sections changes according to the road situations
- Driving on a road under construction
- Driving on a road that is controlled
- There is bad weather, such as heavy rain, heavy snow, etc.
- Driving on a road that is sharply curved

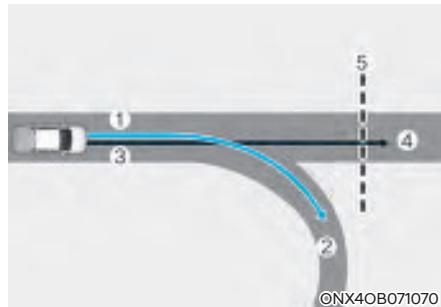

[1] : Set route, [2] : Branch line, [3] : Driving route,  
[4] : Main road, [5] : Curved road section

- When there is a difference between the navigation set route (branch line) and the driving route (main road), Highway Auto Curve Slowdown function may not operate until the driving route is recognized as the main road.
- When the vehicle's driving route is recognized as the main road by maintaining the main road instead of the navigation set route, Highway Auto Curve Slowdown function will operate. Depending on the distance to the curve and the current vehicle speed, vehicle deceleration may not be sufficient or may decelerate rapidly.

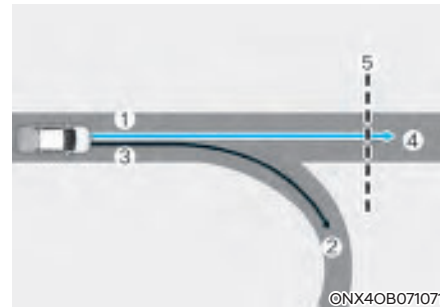

[1] : Set route, [2] : Branch line, [3] : Driving route,  
[4] : Main road, [5] : Curved road section

- When there is a difference between the navigation route (main road) and the driving route (branch line), Highway Auto Curve Slowdown function will operate based on the curve information on the main road.
- When it is judged that you are driving out of the route by entering the highway interchange or junction, Highway Auto Curve Slowdown function will not operate.

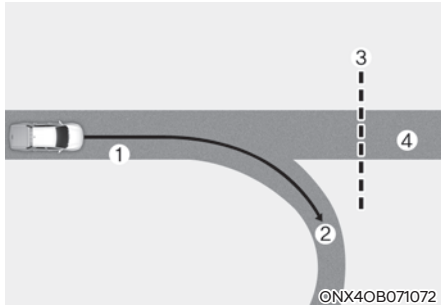

[1] : Driving route, [2] : Branch line,  
[3] : Curved road section, [4] : Main road

- If there is no destination set on the navigation, Highway Auto Curve Slowdown function will operate based on the curve information on the main road.
- Even if you depart from the main road, Highway Auto Curve Slowdown function may temporarily operate due to navigation information of the highway curve section.

 **WARNING**

- **Navigation-based Smart Cruise Control is not a substitute for safe driving practices, but a convenience function. Always have your eyes on the road, and it is the responsibility of the driver to avoid violating traffic laws.**
- **The navigation's speed limit information may differ from the actual speed limit information on the road. It is the driver's responsibility to check the speed limit on the actual driving road or lane.**
- **Navigation-based Smart Cruise Control will automatically be cancelled when you leave the highway main road. Always pay attention to road and driving conditions while driving.**
- **Navigation-based Smart Cruise Control may not operate due to the existence of leading vehicles and the driving conditions of the vehicle. Always pay attention to road and driving conditions while driving.**
- **When you are towing a trailer or another vehicle, we recommend that Navigation-based Smart Cruise Control is turned off due to safety reasons.**

- After you pass through a tollgate on a highway, Navigation-based Smart Cruise Control will operate based on the first lane. If you enter one of the other lanes, Navigation-based Smart Cruise Control may not operate properly.
- The vehicle will accelerate if the driver depresses the accelerator pedal while Navigation-based Smart Cruise Control is operating, and the function will not decelerate the vehicle. However, if the accelerator pedal is depressed insufficiently, the vehicle may decelerate.
- If the driver accelerates and releases the accelerator pedal while Navigation-based Smart Cruise Control is operating, the vehicle may not decelerate sufficiently or may rapidly decelerate to a safe speed.
- If the curve is too large or too small, Navigation-based Smart Cruise Control may not operate.

### **i** Information

- A time gap could occur between the navigation's guidance and when Navigation-based Smart Cruise Control operation starts and ends.
- The speed information on the cluster and navigation may differ.
- Even if you are driving at a speed lower than Smart Cruise Control set speed, acceleration may be limited by the curve sections ahead.
- If Navigation-based Smart Cruise Control is operating while leaving the main road to enter an interchange, junction, rest area, etc., the function may operate for a certain period of time.
- Deceleration by Navigation-based Smart Cruise Control may feel it is not sufficient due to road conditions such as uneven road surfaces, narrow lanes, etc.

### **i** Information

This device complies with Part 15 of the FCC rules.

Operation is subject to the following three conditions:

1. This device may not cause harmful interference, and
2. This device must accept any interference received, including interference that may cause undesired operation.
3. Changes or modifications not expressly approved by the party responsible for compliance could void the user's authority to operate the device.

### **i** Information

Radio frequency radiation exposure information:

This equipment complies with FCC radiation exposure limits set forth for an uncontrolled environment.

This equipment should be installed and operated with minimum distance of 8 in. (20 cm) between the radiator (antenna) and your body.

This transmitter must not be co-located or operating in conjunction with any other antenna or transmitter.

## LANE FOLLOWING ASSIST (LFA)

Lane Following Assist is designed to detect lane markings on the roadway and/or a vehicle directly in front and automatically provides steering inputs to help keep your vehicle centered in the lane or following the vehicle in front of you.

### Detecting sensor



[1] : Front view camera

The front view camera is used as a detecting sensor to help detect lane markings and vehicles in front.

Refer to the picture above for the detailed location of the detecting sensor.



### CAUTION

For more details on the precautions of the front view camera, refer to “Forward Collision-Avoidance Assist (FCA)” section in chapter 7.

## Lane Following Assist Settings

### Setting features

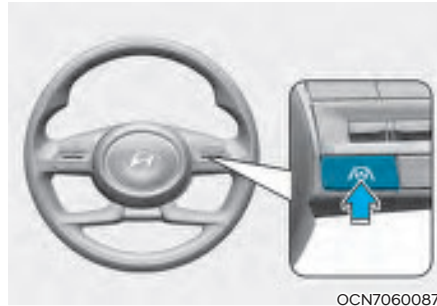

### Turning Lane Following Assist On/Off

With the engine on, shortly press the Lane Driving Assist button located on the steering wheel to turn on Lane Following Assist. The white or green indicator light illuminates on the cluster.

Press the button again to turn off the function.

If the engine is restarted, Lane Following Assist will maintain the last setting.



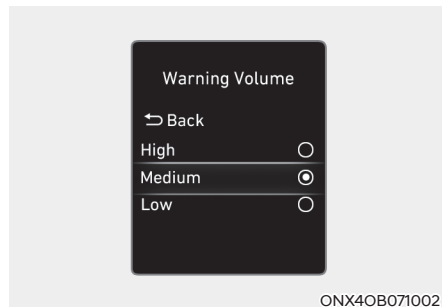

### Warning Volume

With the engine on, select 'Driver Assistance → Warning Volume' from the Settings menu to change the Warning Volume to 'High', 'Medium' or 'Low' for Hands-off warning.

If you change the Warning Volume, the Warning Volume of other Driver Assistance systems may change.

## Lane Following Assist Operation

### Warning and control

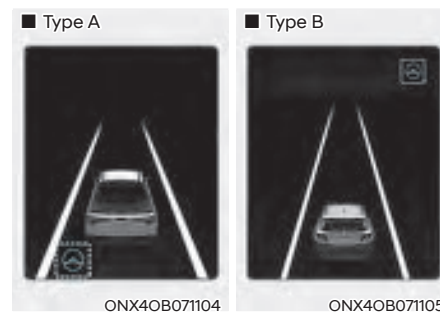

### Lane Following Assist

If the vehicle ahead and/or both lane markings are detected and your vehicle speed is below 110 mph (180 km/h), the green  indicator light illuminates on the cluster, and Lane Following Assist helps center the vehicle in the lane by assisting the steering wheel.



### CAUTION

When the steering wheel is not assisted, the green  indicator light blinks and changes to white.

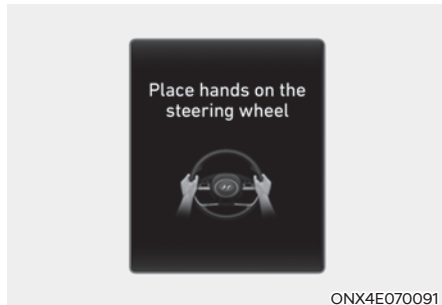

### Hands-off warning

If the driver takes their hands off the steering wheel for several seconds, the 'Place hands on the steering wheel' warning message appears and an audible warning sounds in stages.

First stage : Warning message

Second stage : Warning message (red steering wheel) and audible warning

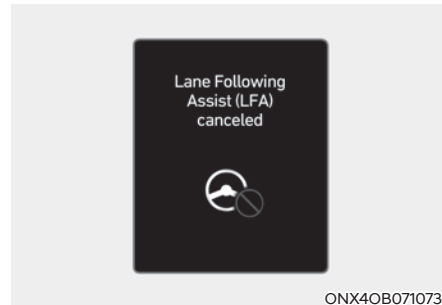

If the driver still does not have their hands on the steering wheel after the hands-off warning, the 'Lane Following Assist (LFA) canceled' warning message appears and Lane Following Assist is automatically canceled.



### WARNING

- **The Lane Following steering wheel effort can be overcome if the steering wheel is held tightly or if the driver steers the vehicle beyond a certain angle.**
- **Lane Following Assist does not operate at all times. It is the responsibility of the driver to safely steer the vehicle and to maintain the vehicle in its lane.**
- **The hands-off warning message may appear late depending on road conditions. Always have your hands on the steering wheel while driving.**
- **If the steering wheel is held very lightly the hands-off warning message may appear because Lane Following Assist may not recognize that the driver has their hands on the steering wheel.**
- **If you attach objects to the steering wheel, the hands-off warning may not work properly.**

### **i** Information

- When both lane markings are detected, the lane lines on the cluster will change from grey to white.

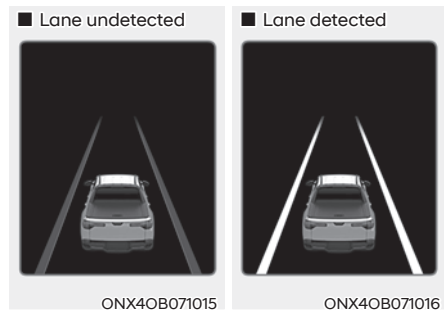

- The images and colors in the cluster may differ depending on the cluster type or theme selected from the cluster.
- If lane markings are not detected, steering wheel control by Lane Following Assist can be limited depending on whether a vehicle is in front or the driving conditions of the vehicle.
- Even though the steering is assisted by Lane Following Assist, the driver may control the steering wheel.
- The steering wheel may feel heavier or lighter when the steering wheel is assisted by Lane Following Assist than when it is not.

### Lane Following Assist Malfunction and Limitations

#### **Lane Following Assist malfunction**

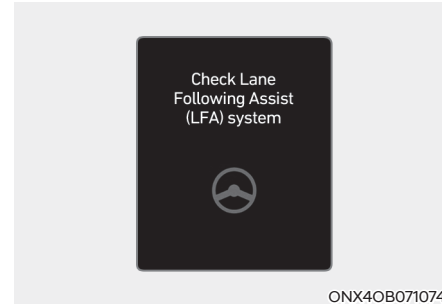

When Lane Following Assist is not working properly, the 'Check Lane Following Assist (LFA) system' warning message appears for several seconds, and the master (⚠) warning light illuminates on the cluster. If this occurs, have the vehicle inspected by an authorized HYUNDAI dealer.

#### **Limitations of Lane Following Assist**

For more details on Lane Following Assist limitations, refer to "Lane Keeping Assist (LKA)" section in chapter 7.

### **i** Information

For more details on Lane Following Assist precautions, refer to "Lane Keeping Assist (LKA)" section in chapter 7.

## HIGHWAY DRIVING ASSIST (HDA) (IF EQUIPPED)

Highway Driving Assist combines the features of Smart Cruise Control along with the features of Lane Following Assist and the navigation-based information related to highway speed limits to help keep your vehicle centered in the lane and to also maintain the highway speed limit.

### **i** Information

Highway Driving Assist is useful on long drives and may help to reduce driver fatigue.

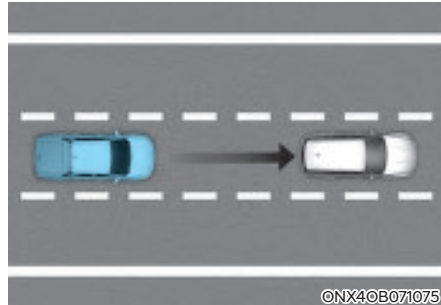

### **i** Information

- Highway Driving Assist is available only on controlled access road of certain highways.
  - \* Controlled access road indicates roads with limited entrances and exits that allow uninterrupted high speed traffic flow. Only passenger cars and motorcycles are allowed on controlled access roads.

Available highway (Controlled access road)	
USA	Select Interstate Highway and U.S. (Federal) and State Highways
Canada	Select Provincial and Territorial Highways

- Additional highways may be expanded by future navigation updates.

### **i** Information

Highway Driving Assist operates on main roads of highways, and does not operate on interchanges or junctions.

### Detecting sensor



[1] : Front view camera,  
[2] : Front radar

Refer to the picture above for the detailed location of the detecting sensors.



#### CAUTION

For more details on the precautions of the detecting sensors, refer to “Forward Collision-Avoidance Assist (FCA)” section in chapter 7.

### Highway Driving Assist Settings Setting features

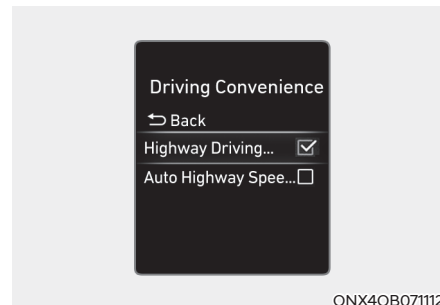

#### Highway Driving Assist

With the engine on, select or deselect 'Driver Assistance → Driving Convenience' from the Settings menu to set whether to use the following function(s).

- If 'Highway Driving Assist' is selected, it helps maintain distance from the vehicle ahead, maintain the set speed, and helps center the vehicle in the lane.

#### **i** Information

- If there is a problem with the function(s), the settings cannot be changed. We recommend that the vehicle be inspected by an authorized HYUNDAI dealer.
- If the engine is restarted, the function(s) will maintain the last setting.

**WARNING**

For your safety, change the Settings after parking the vehicle at a safe location.

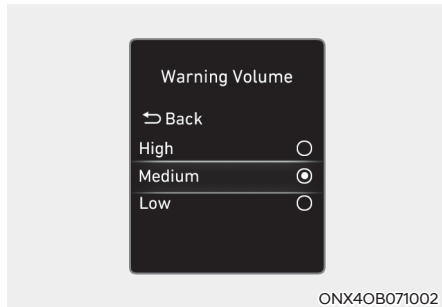

**Warning Volume**

With the engine on, select 'Driver Assistance → Warning Volume' from the Settings menu to change the Warning Volume to 'High', 'Medium' or 'Low' for Highway Driving Assist.

If you change the Warning Volume, the Warning Volume of other Driver Assistance systems may change.

**Highway Driving Assist Operation**

**Display and control**

You can see the status of the Highway Driving Assist operation in the Driving Assist mode on the cluster. Refer to "LCD Display Modes" section in chapter 4.

Highway Driving Assist will be displayed as below depending on the status of the function.

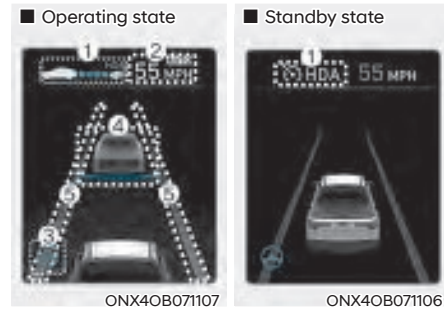

- (1) Highway Driving Assist indicator, whether there is a vehicle ahead and the selected distance level
  - \* Highway Driving Assist indicator
    - Green [HDA] : Operating state
    - White [HDA] : Standby state
- (2) Set speed
- (3) Lane Following Assist indicator
- (4) Whether there is a vehicle ahead and the selected vehicle distance
- (5) Whether the lane is detected or not

For more details on the display refer to "Smart Cruise Control (SCC)" and "Lane Following Assist (LFA)" sections in chapter 7.

**Highway Driving Assist operating status**

Highway Driving Assist operates when:

- Driving on the main road of highways, and turning on Highway Driving Assist by pressing the Driving Assist (🚗) button.
- Entering the main road of highways while Lane Following assist and Smart Cruise Control are operating.

***i* Information**

**The images and colors in the cluster may differ depending on the cluster type or theme selected from the cluster.**

- Restarting after stopping



When Highway Driving Assist is operating, your vehicle will stop if the vehicle ahead of you stops. Also, if the vehicle ahead of you starts moving within 30 seconds after the stop, your vehicle will start as well. In addition, after the vehicle has stopped and 30 seconds have passed, the 'Use switch or pedal to accelerate' message appears on the cluster. Depress the accelerator pedal or push the + switch, - switch or  switch to start driving.

- Hands-off warning

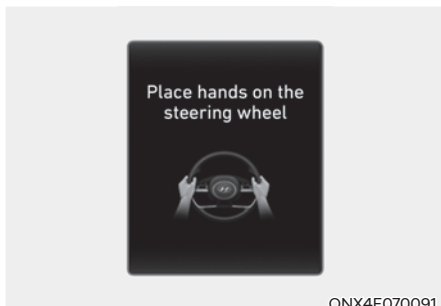

If the driver takes their hands off the steering wheel for several seconds, the 'Place hands on the steering wheel' warning message appears and an audible warning sounds in stages.  
First stage : Warning message  
Second stage : Warning message (red steering wheel) and audible warning

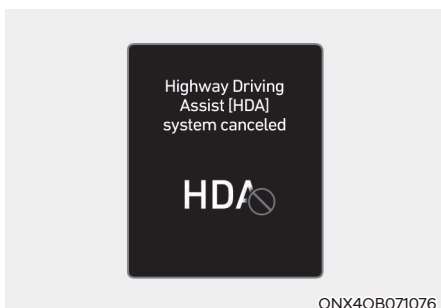

If the driver still does not have their hands on the steering wheel after the hands-off warning, the 'Highway Driving Assist (HDA) canceled' warning message appears and Highway Driving Assist and Lane Change Assist are automatically canceled.

#### Highway Driving Assist standby

When Smart Cruise Control is temporarily canceled while Highway Driving Assist is operating, Highway Driving Assist will be in the standby state. At this time, Lane Following Assist will operate properly.

#### Highway Driving Assist Malfunction and Limitations

##### Highway Driving Assist malfunction

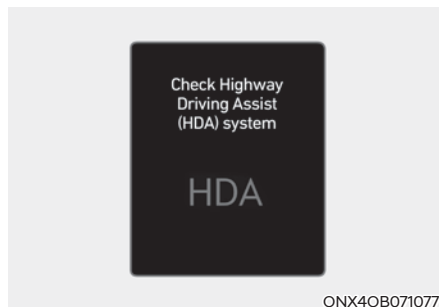

When Highway Driving Assist is not working properly, the 'Check Highway Driving Assist (HDA) system' warning message appears, and the  warning light illuminates on the cluster. Have the vehicle inspected by an authorized HYUNDAI dealer.



**WARNING**

- The driver is responsible for controlling the vehicle for safe driving.
- Always have your hands on the steering wheel while driving.
- Highway Driving Assist is a supplemental function that assists the driver in driving the vehicle and is not a complete autonomous driving system. Always check road conditions, and if necessary, take appropriate actions to drive safely.
- Always have your eyes on the road, and it is the responsibility of the driver to avoid violating traffic laws. The vehicle manufacturer is not responsible for any traffic violation or accidents caused by the driver.
- Highway Driving Assist may not be able to recognize all traffic situations. Highway Driving Assist may not detect possible collisions due to limitations of the function. Always be aware of the limitations of the function. Obstacles such as vehicles, motorcycles, bicycles, pedestrians, or unspecified objects or structures such as guardrails, tollgate, etc., that may collide with the vehicle may not be detected.
- Highway Driving Assist will turn off automatically under the following situations:
  - Driving on roads that Highway Driving Assist does not operate, such as a rest area, intersection, junction, etc.
  - The navigation does not operate properly such as when the navigation is being updated or restarted
- Highway Driving Assist may inadvertently operate or turn off depending on road conditions (navigation information) and surroundings.
- Lane Following Assist function may be temporarily disabled when the front view camera cannot detect lanes properly or the hands-off warning is on.
- You may not hear the warning sound of Highway Driving Assist if the surrounding is noisy.
- If the vehicle is driven at high speed above a certain speed at a curve, your vehicle may drive to one side or may depart from the driving lane.
- When you are towing a trailer or another vehicle, we recommend that Highway Driving Assist is turned off due to safety reasons.
- The hands-off warning message may appear early or late depending on how the steering wheel is held or road conditions. Always have your hands on the steering wheel while driving.
- For your safety, please read the owner's manual before using the Highway Driving Assist.
- Highway Driving Assist will not operate when the engine is started, or when the detecting sensors or navigation is being initialized.

### **Limitations of Highway Driving Assist**

Highway Driving Assist may not operate properly, or may not operate under the following circumstances:

- The map information and the actual road is different because the navigation is not updated
- The map information and the actual road is different because of real-time GPS data or map information error
- The infotainment system is overloaded by simultaneously performing functions such as route search, video playback, voice recognition, etc.
- GPS signals are blocked in areas such as a tunnel
- The driver goes off course or the route to the destination is changed or canceled by resetting the navigation
- The vehicle enters a service station or rest area
- Android Auto or Car Play is operating
- The navigation cannot detect the current vehicle position (for example, elevated roads including overpass adjacent to general roads or nearby roads exist in a parallel way)

### ***i* Information**

For more details on the limitations of the front view camera and front radar, refer to “Forward Collision-Avoidance Assist (FCA)” section in chapter 7.

### ***i* Information**

This device complies with Part 15 of the FCC rules.

Operation is subject to the following three conditions:

1. This device may not cause harmful interference, and
2. This device must accept any interference received, including interference that may cause undesired operation.
3. Changes or modifications not expressly approved by the party responsible for compliance could void the user's authority to operate the device.

### ***i* Information**

Radio frequency radiation exposure information:

This equipment complies with FCC radiation exposure limits set forth for an uncontrolled environment.

This equipment should be installed and operated with minimum distance of 8 in. (20 cm) between the radiator (antenna) and your body.

This transmitter must not be co-located or operating in conjunction with any other antenna or transmitter.

**REAR VIEW MONITOR (RVM) (IF EQUIPPED)****Camera**

[1] : Rear view camera

Refer to the picture above for the detailed location of the camera.



Rear View Monitor shows the area behind the vehicle to assist you when parking or backing up.

## Rear View Monitor Settings

### Camera settings



You can change Rear View Monitor 'Display Contents' or 'Display Settings' by touching the setup icon (⚙️) on the screen while Rear View Monitor is operating, or selecting 'Driver Assistance → Parking Safety → Camera Settings' from the Settings menu while the engine is on.

- In the Display Contents, you can change settings for 'Rear View', and in the Display Settings, you can change the screen's 'Brightness' and 'Contrast'.

### **Extend Rear Camera Use**

With the engine on, select 'Display → Extend Rear Camera Use' from the Infotainment system Setup menu to turn on Extended rear view function and deselect to turn off the function.

## Rear View Monitor Operation

### Operating button

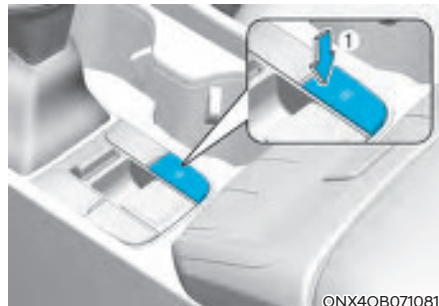

### **Parking/View button**

Press the Parking/View button (1) to turn on Rear View Monitor.

Press the button again to turn off the function.

**Rear view****Operating conditions**

- Shift the gear to R (Reverse), the rear view image appears on the screen.
- Press the Parking/View button (1) while the gear is in P (Park), the rear view image appears on the screen.

**Off conditions**

- The rear view cannot be turned off when the gear is in R (Reverse).
- Press the Parking/View button (1) again while the gear is in P (Park) with the rear view on the screen, the rear view turns off.
- Shift the gear from R (Reverse) to P (Park), the rear view turns off.

**Extended rear view function**

The rear view will maintain showing on the screen to help you when parking.

**Operating conditions**

Shift the gear from R (Reverse) to N (Neutral) or D (Drive), the rear view appears on the screen.

**Off conditions**

- When vehicle speed is above 6 mph (10 km/h), the rear view turns off.
- Shift the gear to P (Park), the rear view turns off.
- Press the Parking/View button (1), the rear view turns off.

**Rear top view**

When you touch the  icon, the top view is displayed on the screen and shows the distance from the vehicle in the back of your vehicle while parking.

## Rear View Monitor Malfunction and Limitations

### ***Rear View Monitor malfunction***

When Rear View Monitor is not working properly, or the screen flickers, or the camera image does not display properly, have the vehicle inspected by an authorized HYUNDAI dealer.

### ***Limitations of Rear View Monitor***

When the vehicle is stopped for a long time in winter or when the vehicle is parked in an indoor parking lot, the exhaust fumes may temporarily blur the image.



### **WARNING**

- **The rear view camera does not cover the complete area behind the vehicle. The driver should always check the rear area directly through the inside and side view mirror before parking or backing up.**
- **The image shown on the screen may differ from the actual distance of the object. Make sure to directly check the vehicle's surroundings for safety.**
- **Always keep the rear view camera lens clean. If the lens is covered with foreign material, it may adversely affect camera performance and Rear View Monitor may not operate properly. However, do not use chemical solvents such as strong detergents containing high alkaline or volatile organic solvents (gasoline, acetone, etc.). This may damage the camera lens.**

## SURROUND VIEW MONITOR (SVM) (IF EQUIPPED)

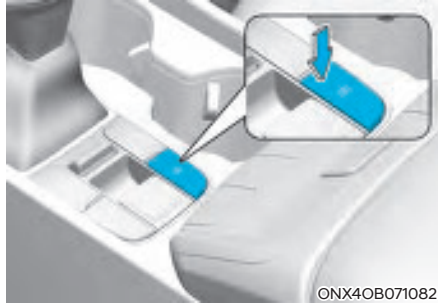

Surround View Monitor can assist in parking by allowing the driver to see around the vehicle.

### Detecting sensor



- [1] : Surround-front view camera,
- [2],[3] : Surround-side view camera  
(under the side view mirror),
- [4] : Surround-rear view camera

Refer to the picture above for the detailed location of the cameras.

## Surround View Monitor Settings Camera settings

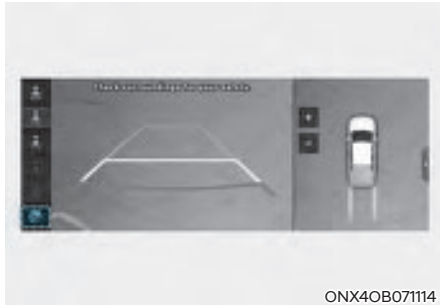

- You can change Surround View Monitor 'Display Contents' or 'Display Settings' by touching the setup icon (⚙️) on the screen while Surround View Monitor is operating, or selecting 'Driver Assistance → Parking Safety → Camera Settings' from the Settings menu while the engine is on.
- In the Display Contents, you can change settings for 'Top View Parking Guidance' and 'Rear View Parking Guidance'.
- In the Display Settings, you can change the screen's 'Brightness' and 'Contrast'.

## Top View Parking Guidance



- When the 'Top View Parking Guidance' is selected, parking guidance is displayed on the right side of the Surround View Monitor screen.
- The 'Top View Parking Guidance' can be connected with the front top view parking guidance or the rear top view parking guidance.



### Rear View Parking Guidance

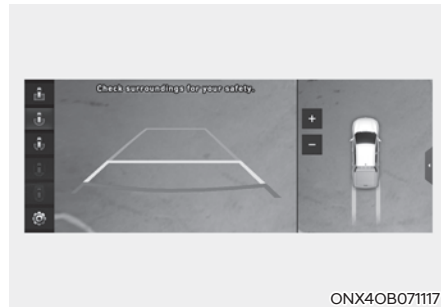

- When the 'Rear View Parking Guidance' is selected, parking guidance is displayed in the rear view.
- The horizontal guideline of the Rear View Parking Guidance shows the distance of 1.6 ft (0.5m), 3.3 ft (1 m) and 7.6 ft (2.3m) from the vehicle.

### Surround View Monitor Auto On

With the engine on, select 'Driver Assistance → Parking Safety → Surround View Monitor Auto On' from the Settings menu to use the function.

### Surround View Monitor Operation

#### Operating button

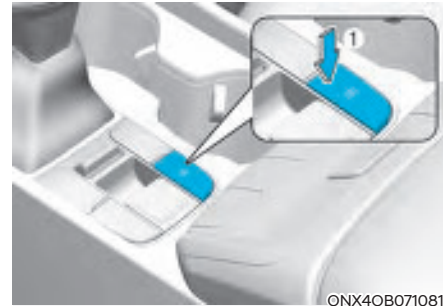

- Press the Parking/View button (1) to turn on Surround View Monitor. Press the button again to turn off the function.
- Other view modes can be selected by touching the view icons (2) on the Surround View Monitor screen.
- When one of the infotainment system button (3) is pressed without the gear in R (Reverse), Surround View Monitor turns off.

### **Front view**

The front image is displayed on the screen when the gear is in N (Neutral) or D (Drive) to assist in parking. The front view has a top view/front view/side view.

### **Operating conditions**

- When the gear is shifted from R (Reverse) to N (Neutral) or D (Drive), the last set mode of front view function will be selected.
- Front view function will operate when the following conditions are satisfied:
  - While the infotainment system screen is being displayed, press the Parking/View button (1) briefly when the gear is in D (Drive) or N (Neutral) and vehicle speed is below 6 mph (10 km/h).
- Surround View Monitor Auto On function will operate when the following conditions are satisfied:
  - With 'Driver Assistance → Parking Safety → Surround View Monitor Auto On' selected from the Settings menu, the front parking assist view screen is displayed when Parking Distance Warning warns the driver while driving in D (Drive).

### **Off conditions**

- Press the Parking/View button (1) again, the image turns off.
- When vehicle speed is above 6 mph (10 km/h) with the gear in D (Drive), Surround View Monitor turns off and the screen will change back to the previous infotainment system screen. Although you drive below 6 mph (10 km/h) again, Surround View Monitor will not turn on.
- Press one of the infotainment system button (3), the screen will change to the infotainment system screen.
- Shift the gear to P (Park), the image turns off.

### **Rear view**

The rear image is displayed on the screen when the gear is in R (Reverse) or P (Park) to assist in parking. The rear view has a top view/rear view/side view.

### **Operating conditions**

- Shift the gear to R (Reverse), the image appears on the screen.
- Press the Parking/View button (1) while the gear is in P (Park), the image appears on the screen.

### **Off conditions**

- The image cannot be turned off when the gear is in R (Reverse).
- Shift the gear from R (Reverse) to P (Park), the image turns off.
- Press the Parking/View button (1) again while the gear is in P (Park) with the image on the screen.

## Surround View Monitor Malfunction and Limitations

### **Surround View Monitor malfunction**

When Surround View Monitor is not working properly, or the screen flickers, or the camera image does not display properly, have the vehicle inspected by an authorized HYUNDAI dealer.

### **Limitations of Surround View Monitor**

- When the vehicle is stopped for a long time in winter or when the vehicle is parked in an indoor parking lot, the exhaust fumes may temporarily blur the image.
- The screen may be displayed abnormally, and an icon appears at the top left side of the screen under the following circumstances:
  - The tailgate is opened
  - The driver or front passenger door is opened
  - The side view mirror is folded



### **WARNING**

- **ALWAYS** look around your vehicle to make sure there are no objects or obstacles before moving the vehicle. What you see on the screen may differ from the actual vehicle's location.
- The image shown on the screen may differ from the actual distance of the object. Make sure to directly check the vehicle's surroundings for safety.
- Surround View Monitor is designed to be used on a flat surface. Therefore, if used on roads with different heights such as curbs and speed bumps, the image in the screen may not look correct.
- Always keep the camera lens clean. If the lens is covered with foreign material, it may adversely affect camera performance and Surround View Monitor may not operate properly. However, do not use chemical solvents such as strong detergents containing high alkaline or volatile organic solvents (gasoline, acetone, etc.). This may damage the camera lens.

## REAR CROSS-TRAFFIC COLLISION-AVOIDANCE ASSIST (RCCA) (IF EQUIPPED)

Rear Cross-Traffic Collision-Avoidance Assist is designed to help detect vehicles approaching from the rear left and right side while your vehicle is reversing, and warn the driver that a collision is imminent with a warning message and an audible warning. Also, braking is assisted to help prevent a collision.

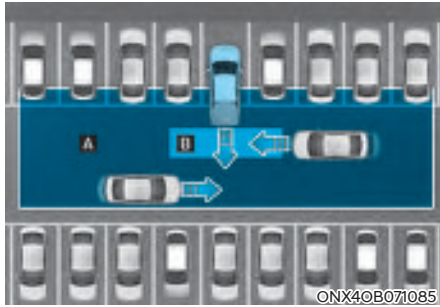

[A] : Rear Cross-Traffic Collision Warning operating range,

[B] : Rear Cross-Traffic Collision-Avoidance Assist operating range

### CAUTION

Warning timing may vary depending on vehicle speed of the approaching vehicle.

### *Detecting sensor*



[1] : Rear corner radar

Refer to the picture above for the detailed location of the detecting sensors.

### CAUTION

For more details on the precautions of the rear corner radar, refer to “Blind-Spot Collision-Avoidance Assist (BCA)” section in chapter 7.

## Rear Cross-Traffic Collision-Avoidance Assist Settings

### Setting features

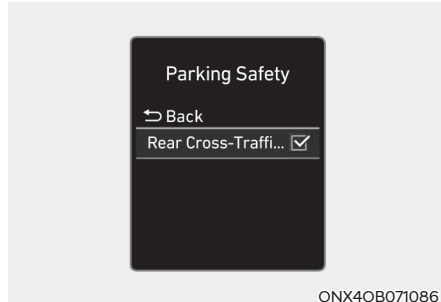

#### Rear Cross-Traffic Safety

With the engine on, select 'Driver Assistance → Parking Safety → Rear Cross-Traffic Safety' from the Settings menu to turn on Rear Cross-Traffic Collision-Avoidance Assist and deselect to turn off the function.



#### WARNING

When the engine is restarted, Rear Cross-Traffic Collision-Avoidance Assist will always turn on. However, if 'Off' is selected after the engine is restarted, the driver should always be aware of the surroundings and drive safely.



#### Information

Settings for Rear Cross-Traffic Safety system include Rear Cross-Traffic Collision Warning and Rear Cross-Traffic Collision-Avoidance Assist.

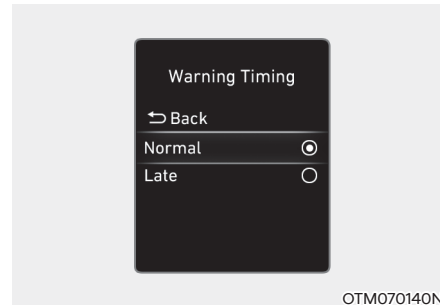

#### Warning Timing

With the engine on, select 'Driver Assistance → Warning Timing' from the Settings menu to change the initial warning activation time for Rear Cross-Traffic Collision-Avoidance Assist.

When the vehicle is first delivered, Warning Timing is set to 'Normal'. If you change the Warning Timing, the Warning Timing of other Driver Assistance systems may change.

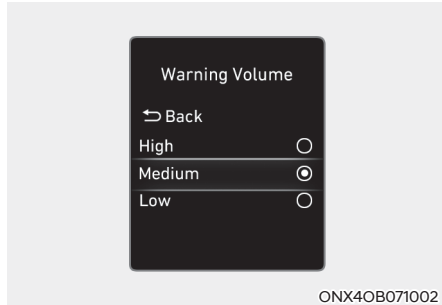

### Warning Volume

With the engine on, select 'Driver Assistance → Warning Volume' from the Settings menu to change the Warning Volume to 'High', 'Medium' or 'Low' for Rear Cross-Traffic Collision- Avoidance Assist.

If you change the Warning Volume, the Warning Volume of other Driver Assistance systems may change.

### CAUTION

- The setting of the Warning Timing and Warning Volume applies to all functions of the Rear Cross-Traffic Collision-Avoidance Assist.
- Even though 'Normal' is selected for Warning Timing, if a vehicle from the left or right side approaches at high speed, the warning may seem late.
- Select 'Late' for Warning Timing when traffic is light and when driving speed is slow.

### Information

If the engine is restarted, Warning Timing and Warning Volume will maintain the last setting.

## Rear Cross-Traffic Collision-Avoidance Assist Operation

### Warning and control

Rear Cross-Traffic Collision- Avoidance Assist will warn and help control the vehicle depending on the collision risk level: 'Collision Warning', 'Emergency Braking' and 'Stopping vehicle and ending brake control'.



### Collision Warning

- To warn the driver of an approaching vehicle from the rear left/right side of your vehicle, the warning light on the side view mirror blinks and a warning appears on the cluster. At the same time, an audible warning sounds. If Rear View Monitor is operating, a warning also appears on the infotainment system screen.

- Rear Cross-Traffic Collision-Avoidance Assist operates when all the following conditions are satisfied:
  - The gear is shifted to R (Reverse)
  - Vehicle speed is below 5 mph (8 km/h)
  - The approaching vehicle is within approximately 82 ft. (25 m) from the left or right side of your vehicle
  - The speed of the vehicle approaching from the left and right is above 3 mph (5 km/h)

### **i** Information

- **If the operating conditions are satisfied, there will be a warning whenever the vehicle approaches from the left or right side even though your vehicle speed is 0 mph (0 km/h).**
- **The images and colors in the cluster may differ depending on the cluster type or theme selected from the cluster.**



### Emergency Braking

- To warn the driver of an approaching vehicle from the rear left/right side of your vehicle, the warning light on the side view mirror blinks and, the 'Emergency Braking' warning message appears on the cluster. At the same time, an audible warning sounds. If Rear View Monitor is operating, a warning also appears on the infotainment system screen.

- Rear Cross-Traffic Collision-Avoidance Assist operates when all the following conditions are satisfied:
  - The gear is shifted to R (Reverse)
  - Vehicle speed is below 5 mph (8 km/h)
  - The approaching vehicle is within approximately 5 ft. (1.5 m) from the left or right side of your vehicle
  - The speed of the vehicle approaching from the left and right is above 3 mph (5 km/h)
- Emergency braking is assisted to help prevent collision with approaching vehicles from the left and right.



### **WARNING**

**Brake control ends when the conditions of the approaching vehicle from the rear left or right side are as below:**

- **The approaching vehicle is out of the detecting range**
- **The approaching vehicle passes behind your vehicle**
- **The approaching vehicle does not drive toward your vehicle**
- **The approaching vehicle speed slows down**
- **The driver depresses the brake pedal with sufficient power**

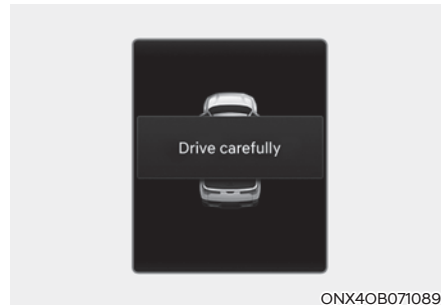

ONX4OB071089

### **Stopping vehicle and ending brake control**

- When the vehicle is stopped due to emergency braking, the 'Drive carefully' warning message appears on the cluster.
- For your safety, the driver should depress the brake pedal immediately and check the surroundings.
- Brake control ends after the vehicle is stopped by emergency braking for approximately 2 seconds.
- During emergency braking, braking control by Rear Cross-Traffic Collision-Avoidance Assist automatically cancels when the driver excessively depresses the brake pedal.



 **WARNING**

Take the following precautions when using Rear Cross-Traffic Collision-Avoidance Assist:

- For your safety, change the Settings after parking the vehicle at a safe location.
- If any other system's warning message is displayed or audible warning is generated, Rear Cross-Traffic Collision-Avoidance Assist's warning message may not be displayed and audible warning may not be generated.
- You may not hear the warning sound of Rear Cross-Traffic Collision-Avoidance Assist if the surrounding is noisy.
- Rear Cross-Traffic Collision-Avoidance Assist may not operate if the driver applies the brake pedal to avoid collision.
- During Rear Cross-Traffic Collision-Avoidance Assist operation, the vehicle may stop suddenly injuring passengers and shifting loose objects. Always have the seat belt on and keep loose objects secured.
- Even if there is a problem with Rear Cross-Traffic Collision-Avoidance Assist, the vehicle's basic braking performance will operate properly.
- When Rear Cross-Traffic Collision-Avoidance Assist is operating, braking control by the function will automatically cancel when the driver excessively depresses the accelerator pedal.
- Rear Cross-Traffic Collision-Avoidance Assist does not operate in all situations or cannot avoid all collisions.
- Rear Cross-Traffic Collision-Avoidance Assist may warn the driver late or may not warn the driver depending on the road and driving conditions.

- The driver is solely responsible to operate the vehicle in a safe manner. Do not solely depend on Rear Cross-Traffic Collision-Avoidance Assist. Rather, maintain a safe braking distance, and if necessary, depress the brake pedal to reduce driving speed or to stop the vehicle.
- Never deliberately operate Rear Cross-Traffic Collision-Avoidance Assist on people, animal, objects, etc. It may cause serious injury or death.

 **CAUTION**

The brake control may not operate properly depending on the status of ESC (Electronic Stability Control).

There will only be a warning when:

- The ESC (Electronic Stability Control) warning light is on
- ESC (Electronic Stability Control) is engaged in a different function

 **Information**

If braking is assisted by Rear Cross-Traffic Collision-Avoidance Assist, you must immediately depress the brake pedal and check vehicle surroundings.

- Brake control ends when you depress the brake pedal with sufficient power.
- After shifting the gear to R (Reverse), braking control operates once for left and right vehicle approach.

## Rear Cross-Traffic Collision-Avoidance Assist Malfunction and Limitations

### Rear Cross-Traffic Collision-Avoidance Assist malfunction

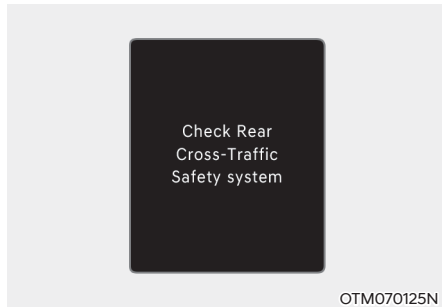

When Rear Cross-Traffic Collision-Avoidance Assist is not working properly, the 'Check Rear Cross-Traffic Safety system' warning message will appear on the cluster for several seconds, and the master (⚠) warning light will illuminate on the cluster. If this occurs, have the vehicle inspected by an authorized HYUNDAI dealer.

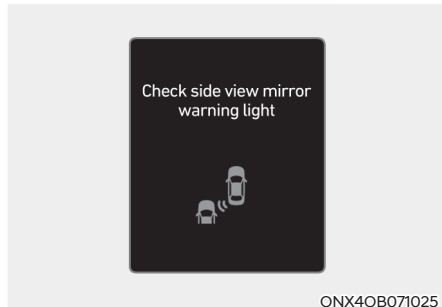

When the side view mirror warning light is not working properly, the 'Check side view mirror warning light' warning message will appear on the cluster for several seconds, and the master (⚠) warning light will illuminate on the cluster. If this occurs, have the vehicle inspected by an authorized HYUNDAI dealer.

### Rear Cross-Traffic Collision-Avoidance Assist disabled

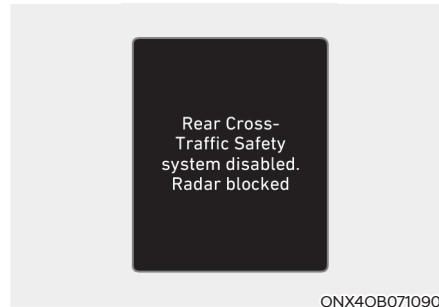

When the rear bumper around the rear-side radar or sensor is covered with foreign material, such as snow or rain, or installing a trailer or carrier, it can reduce the detecting performance and temporarily limit or disable Rear Cross-Traffic Collision-Avoidance Assist.

If this occurs, the 'Rear Cross-Traffic Safety system disabled. Radar blocked' warning message appears on the cluster.

Rear Cross-Traffic Collision-Avoidance Assist will operate properly when such foreign material or trailer, etc., is removed.

If Rear Cross-Traffic Collision-Avoidance Assist does not operate properly after it is removed, have the vehicle inspected by an authorized HYUNDAI dealer.

### WARNING

- Even though the warning message does not appear on the cluster, Rear Cross-Traffic Collision-Avoidance Assist may not operate properly.
- Rear Cross-Traffic Collision-Avoidance Assist may not operate properly in an area (for example, open terrain), where any objects are not detected after turning ON the engine.

### CAUTION

Turn off Rear Cross-Traffic Collision-Avoidance Assist to install or remove a trailer, carrier, or another attachment. Turn on Rear Cross-Traffic Collision-Avoidance Assist when finished.

### **Limitations of Rear Cross-Traffic Collision-Avoidance Assist**

Rear Cross-Traffic Collision-Avoidance Assist may not operate properly, or it may operate unexpectedly under the following circumstances:

- Departing from where trees or grass are overgrown
- Departing from where roads are wet
- Speed of the approaching vehicle is fast or slow

Braking control may not work, driver's attention is required in the following circumstances:

- The vehicle severely vibrates while driving over a bumpy road, uneven road or concrete patch
- Driving on a slippery surface due to snow, water puddle, ice, etc.
- The tire pressure is low or a tire is damaged
- The brake is tuned

### Information

For more details on the limitations of the rear corner radar, refer to “Blind-Spot Collision-Avoidance Assist (BCA)” section in chapter 7.

### WARNING

- Driving near a vehicle or structure

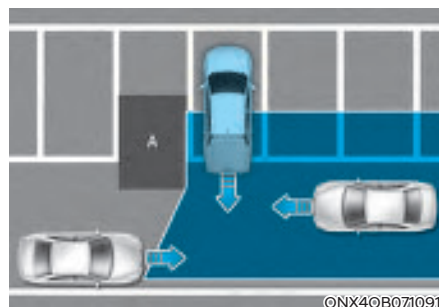

[A] : Structure

**Rear Cross-Traffic Collision-Avoidance Assist may be limited when driving near a vehicle or structure, and may not detect the vehicle approaching from the left or right. If this occurs, the function may not warn the driver or control the brakes when necessary.**

**Always check your surroundings while backing up.**

- When the vehicle is in a complex parking environment

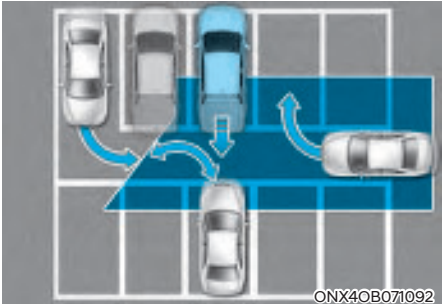

**Rear Cross-Traffic Collision-Avoidance Assist may detect vehicles which are parking or pulling out near your vehicle (for example, a vehicle leaving beside your vehicle, a vehicle parking or pulling out in the rear area, a vehicle approaching your vehicle making a turn, etc.). If this occurs, the function may unnecessarily warn the driver and control the brake. Always check your surroundings while backing up.**

- When the vehicle is parked diagonally

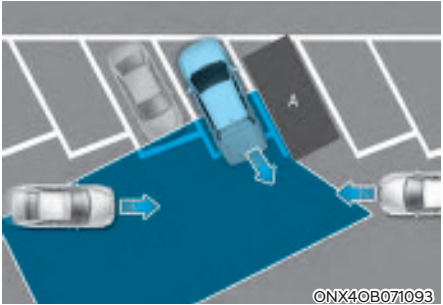

[A] : Vehicle

**Rear Cross-Traffic Collision-Avoidance Assist may be limited when backing up diagonally, and may not detect the vehicle approaching from the left or right. If this occurs, the function may not warn the driver or control the brakes when necessary. Always check your surroundings while backing up.**

- When the vehicle is on or near a slope

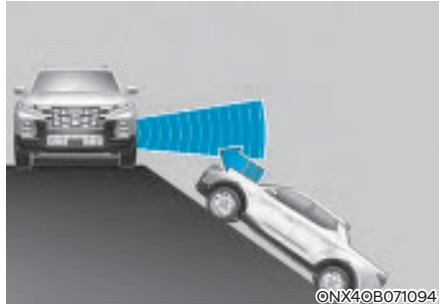

**Rear Cross-Traffic Collision-Avoidance Assist may be limited when the vehicle is on an uphill or downhill slope, or near it, and may not detect the vehicle approaching from the left or right. If this occurs, the function may not warn the driver or control the brakes when necessary.**

**Always check your surroundings while backing up.**

- Pulling into the parking space where there is a structure

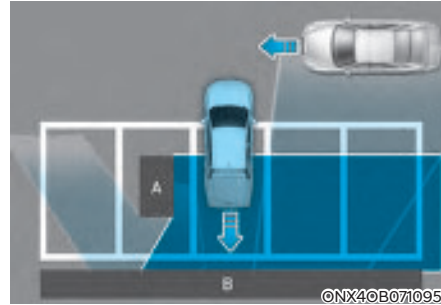

[A] : Structure, [B] : Wall

**Rear Cross-Traffic Collision-Avoidance Assist may detect vehicles passing by in front of you when parking in reverse into a parking space with a wall or structure in the rear or side area. If this occurs, the function may unnecessarily warn the driver and control the brake.**

**Always check your surroundings while backing up.**

- When the vehicle is parked rearward

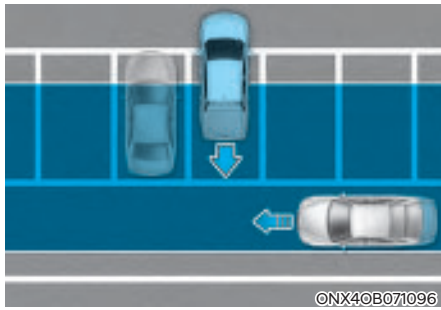

Rear Cross-Traffic Collision-Avoidance Assist may detect vehicles passing by behind you when parking in reverse into a parking space. If this occurs, the function may unnecessarily warn the driver and control the brake.

Always check your surroundings while backing up.

#### **WARNING**

- When you are towing a trailer or another vehicle, we recommend that Rear Cross-Traffic Collision-Avoidance Assist is turned off due to safety reasons.
- Rear Cross-Traffic Collision-Avoidance Assist may not operate normally if interfered by strong electromagnetic waves.
- Rear Cross-Traffic Collision-Avoidance Assist may not operate for 3 seconds after the vehicle is started, or the rear corner radars are initialized.

#### **Information**

This device complies with Part 15 of the FCC rules.

Operation is subject to the following three conditions:

1. This device may not cause harmful interference, and
2. This device must accept any interference received, including interference that may cause undesired operation.
3. Changes or modifications not expressly approved by the party responsible for compliance could void the user's authority to operate the device.

#### **Information**

Radio frequency radiation exposure information:

This equipment complies with FCC radiation exposure limits set forth for an uncontrolled environment.

This equipment should be installed and operated with minimum distance of 8 in. (20 cm) between the radiator (antenna) and your body.

This transmitter must not be co-located or operating in conjunction with any other antenna or transmitter.

## DECLARATION OF CONFORMITY

### Front Radar

The radio frequency components (Front Radar) complies :



The antenna(s) must be installed such that a minimum separation distance of at least 20 cm is maintained between the radiator (antenna) and all persons at all times. This device must not be co-located or operating in conjunction with any other antenna or transmitter.

OANATEL275

### Rear Corner Radar

The radio frequency components (Rear Corner Radar) complies:



The antenna(s) must be installed such that a minimum separation distance of at least 20 cm is maintained between the radiator (antenna) and all persons at all times. This device must not be co-located or operating in conjunction with any other antenna or transmitter.

OANATEL124





## 8. Emergency Situations

---

Hazard Warning Flasher .....	8-2
In Case of an Emergency While Driving .....	8-2
If the Engine Stalls while Driving.....	8-2
If the Engine Stalls at a Crossroad or Crossing .....	8-2
If you have a Flat Tire while Driving .....	8-3
If the Engine will not Start .....	8-3
Jump Starting .....	8-4
If the Engine Overheats .....	8-7
Tire Pressure Monitoring System (TPMS).....	8-9
Check Tire Pressure.....	8-9
Tire Pressure Monitoring System .....	8-10
Low Tire Pressure Warning Light.....	8-11
Low Tire Pressure Position and Tire Pressure Display .....	8-11
TPMS Malfunction Indicator.....	8-12
Changing a Tire with TPMS .....	8-12
If you have a Flat Tire.....	8-14
Jack and Tools .....	8-14
Removing and Storing the Spare Tire .....	8-15
Changing Tires.....	8-16
Storing the Flat Tire.....	8-21
Jack Label.....	8-22
Towing .....	8-23
Towing Service .....	8-23

## HAZARD WARNING FLASHER

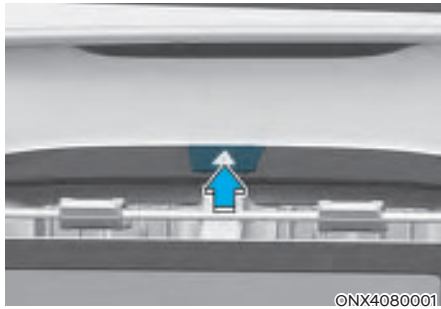

The hazard warning flasher serves as a warning to other drivers to exercise extreme caution when approaching, overtaking, or passing your vehicle.

It should be used whenever emergency repairs are being made or when the vehicle is stopped near the edge of a roadway.

To turn the hazard warning flasher ON or OFF, press the hazard warning flasher button located on the dash.

Note that the ignition or the engine does not have to be on in order to enable the hazard warning flashers. The hazard warning flasher button is located in the center dash panel. All turn signal lights will flash simultaneously.

- The hazard warning flasher operates regardless of whether your vehicle is running or not.
- The turn signals do not work when the hazard flasher is on.

## IN CASE OF AN EMERGENCY WHILE DRIVING

### If the Engine Stalls while Driving

- Reduce your speed gradually, keeping a straight line. Move cautiously off the road to a safe place.
- Turn on your hazard warning flasher.
- Try to start the engine again. If your vehicle will not start, contact an authorized HYUNDAI dealer or seek other qualified assistance.

### If the Engine Stalls at a Crossroad or Crossing

If the engine stalls at a crossroads or crossing, if safe to do so, shift the gear to N (Neutral) and then push the vehicle to a safe location.

### If you have a Flat Tire while Driving

If a tire goes flat while you are driving:

- Take your foot off the accelerator pedal and let the vehicle slow down while driving straight ahead. Do not apply the brakes immediately or attempt to pull off the road as this may cause loss of vehicle control resulting in an accident. When the vehicle has slowed to such a speed that it is safe to do so, brake carefully and pull off the road. Drive off the road as far as possible and park on firm, level ground. If you are on a divided highway, do not park in the median area between the two traffic lanes.
- When the vehicle is stopped, press the hazard warning flasher button, shift the gear to P (Park), apply the parking brake, and press the Engine Start/Stop button to the OFF position or place the ignition switch in the LOCK/OFF position.
- Have all passengers get out of the vehicle. Be sure they all get out on the side of the vehicle that is away from traffic.
- When changing a flat tire, follow the instructions provided later in this chapter.

### IF THE ENGINE WILL NOT START

- Be sure to shift the gear to N (Neutral) or P (Park). The engine starts only when the gear is in N (Neutral) or P (Park).
- Turn on the interior light. If the light dims or goes out when you operate the starter, the battery is drained.  
**See instructions for “Jump Starting” provided in this chapter.**
- Check the fuel level and add fuel if necessary.

If the vehicle still does not start, call an authorized HYUNDAI dealer for assistance.

#### **NOTICE**

**Push or pull starting the vehicle may cause the catalytic converter to overload which can lead to damage to the emission control system.**

## JUMP STARTING

Jump starting can be dangerous if done incorrectly. Follow the jump starting procedure in this section to avoid serious injury or damage to your vehicle. If in doubt about how to properly jump start your vehicle, we strongly recommend that you have a service technician or towing service do it for you.

### **WARNING**

To prevent **SERIOUS INJURY** or **DEATH** to you or bystanders, always follow these precautions when working near or handling the battery:



Always read and follow instructions carefully when handling a battery.



Wear eye protection designed to protect the eyes from acid splashes.



Keep all flames, sparks, or smoking materials away from the battery.



Hydrogen is always present in battery cells, is highly combustible, and may explode if ignited.



Keep batteries out of reach of children.



Batteries contain sulfuric acid which is highly corrosive. Do not allow acid to contact your eyes, skin or clothing.

**If acid gets into your eyes, flush your eyes with clean water for at least 15 minutes and get immediate medical attention. If acid gets on your skin, thoroughly wash the area. If you feel pain or a burning sensation, get medical attention immediately.**

- When lifting a plastic-cased battery, excessive pressure on the case may cause battery acid to leak. Lift with a battery carrier or with your hands on opposite corners.
- Do not attempt to jump start your vehicle if your battery is frozen.
- NEVER attempt to recharge the battery when the vehicle's battery cables are connected to the battery.
- The electrical ignition system works with high voltage.

**NEVER touch these components with the engine running or when the Engine Start/Stop button is in the ON position or when the ignition switch is in the ON position.**

### *Jump starting procedure*

#### **i** Information

Your vehicle has a 12V maintenance free battery located in the engine room. When attempting to jump start your vehicle, open the engine hood and follow the procedures below.

1. Position the vehicles close enough that the jumper cables will reach, but do not allow the vehicles to touch.
2. Avoid fans or any moving parts in the engine compartment at all times, even when the vehicles are turned off.
3. Turn off all electrical devices such as radios, lights, air conditioning, etc. Put the vehicles in P (Park) and set the parking brake. Turn both vehicles OFF.
4. Open the engine hood.

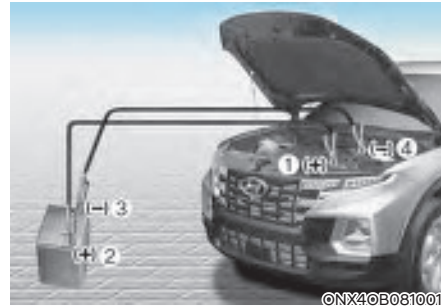

5. Connect the jumper cables in the exact sequence shown in the illustration. First connect one jumper cable to the red, positive (+) jumper terminal of your vehicle (1).
6. Connect the other end of the jumper cable to the red, positive (+) battery/ jumper terminal of the assisting vehicle (2).
7. Connect the second jumper cable to the black, negative (-) battery/ chassis ground of the assisting vehicle (3).
8. Connect the other end of the second jumper cable to the black, negative (-) chassis ground of your vehicle (4).

Do not allow the jumper cables to contact anything except the correct battery or jumper terminals or the correct ground. Do not lean over the battery when making connections.

9. Start the engine of the assisting vehicle and let it run at approximately 2,000 RPM for a few minutes. Then start your vehicle.
10. Keep your vehicle operating for at least 30 minutes at idle or driving to assure your battery receives enough charge to be able to start on its own after the vehicle is shut off. A complete dead battery may require as long as 60 minutes runtime to fully recharge it. If vehicle is run for less, the battery may not restart.

If your vehicle will not start after a few attempts, it probably requires servicing. In this event please seek qualified assistance. If the cause of your battery discharging is not apparent, have your vehicle checked by an authorized HYUNDAI dealer.

Disconnect the jumper cables in the exact reverse order you connected them:

1. Disconnect the jumper cable from the black, negative (-) chassis ground of your vehicle (4).
2. Disconnect the other end of the jumper cable from the black, negative (-) battery/chassis ground of the assisting vehicle (3).
3. Disconnect the second jumper cable from the red, positive (+) battery/jumper terminal of the assisting vehicle (2).
4. Disconnect the other end of the jumper cable from the red, positive (+) jumper terminal of your vehicle (1).

### Information



An inappropriately disposed battery can be harmful to the environment and human health. Dispose of the battery according to your local law(s) or regulations.

### **NOTICE**

To prevent damage to your vehicle:

- Only use a 12-volt power supply (battery or jumper system) to jump start your vehicle.
- Do not attempt to jump start your vehicle by push-starting.

### Information

Main latch release is electronic type. It cannot easily be opened in the case of a power failure.



### **CAUTION**

- Do not store jumper cables in pickup bed floor including underbed storage.
- If you have a lot of cargo placed in the bed area, all cargo must be removed to access underbed storage and jumper cables.

## IF THE ENGINE OVERHEATS

If your temperature gauge indicates overheating, you experience a loss of power, or hear loud pinging or knocking, the engine may be overheating. If this happens, you should:

1. Pull off the road and stop as soon as it is safe to do so.
2. Shift the gear to P (Park) and set the parking brake. If the air conditioning is ON, turn it OFF.
3. If engine coolant is running out under the vehicle or steam is coming out from the hood, stop the engine. Do not open the hood until the coolant has stopped running or the steaming has stopped. If there is no visible loss of engine coolant and no steam, leave the engine running and check to be sure the engine cooling fan is operating. If the fan is not running, turn the engine off.



### WARNING



While the engine is running, keep hands, clothing and tools away from the moving parts such as the cooling fan and drive belt to prevent serious injury.

4. Check for coolant leaking from the radiator, hoses or under the vehicle. (If the air conditioning had been in use, it is normal for cold water to be draining from it when you stop.)
5. If engine coolant is leaking out, stop the engine immediately and call the nearest authorized HYUNDAI dealer for assistance.



### WARNING



Never remove the engine coolant cap and/or water-cooled intercooler coolant cap or the drain plug while the engine and radiator are hot.

Hot coolant and steam may blow out under pressure, causing serious injury.

Turn the engine off and wait until the engine cools down. Use extreme care when removing the coolant cap. Wrap a thick towel around it, and turn it counterclockwise slowly to the first stop. Step back while the pressure is released from the cooling system. When you are sure all the pressure has been released, press down on the cap, using a thick towel, and continue turning counterclockwise to remove it.

6. If you cannot find the cause of the overheating, wait until the engine temperature has returned to normal. Then, if coolant has been lost, carefully add coolant to the reservoir to bring the fluid level in the reservoir up to the halfway mark.
7. Proceed with caution, keeping alert for further signs of overheating. If overheating happens again, call an authorized HYUNDAI dealer for assistance.



### CAUTION

- **Serious loss of coolant indicates a leak in the cooling system and should be checked as soon as possible by an authorized HYUNDAI dealer.**
- **When the engine overheats from low engine coolant, suddenly adding engine coolant may cause cracks in the engine. To prevent damage, add engine coolant slowly in small quantities. It may require several refilling cycles to properly fill the engine cooling system. If necessary, an authorized HYUNDAI dealer should be consulted to perform this task.**



## TIRE PRESSURE MONITORING SYSTEM (TPMS)



- (1) Low Tire Pressure Telltale/TPMS Malfunction Indicator
- (2) Low Tire Pressure Warning Message and Tire Pressure Display (Shown on the LCD display)

### Check Tire Pressure



- You can check the tire pressure in the Warning mode on the cluster.  
**Refer to the “LCD Display Modes” in chapter 4.**
- Tire pressure is displayed after a few minutes of driving after initial engine start up.
- If tire pressure is not displayed when the vehicle is stopped, “Drive to display” message will appear. After driving, check the tire pressure.
- The displayed tire pressure values may differ slightly from those measured with a tire pressure gauge.
- You can change the tire pressure measurement units in the User Settings mode on the instrument cluster.
  - psi, kpa, bar (**Refer to “LCD Modes” in chapter 4).**)

## Tire Pressure Monitoring System



### WARNING

**Over-inflation or under-inflation can reduce tire life, adversely affect vehicle handling, and lead to sudden tire failure that may cause loss of vehicle control resulting in an accident.**

Each tire, including the spare (if provided), should be checked monthly when cold and inflated to the inflation pressure recommended by the vehicle manufacturer on the vehicle placard or tire inflation pressure label. (If your vehicle has tires of a different size than the size indicated on the vehicle placard or tire inflation pressure label, you should determine the proper tire inflation pressure for those tires.)

As an added safety feature, your vehicle has been equipped with a tire pressure monitoring system (TPMS) that illuminates a low tire pressure telltale when one or more of your tires is significantly under-inflated. Accordingly, when the low tire pressure telltale illuminates, you should stop and check your tires as soon as possible, and inflate them to the proper pressure. Driving on a significantly under-inflated tire causes the tire to overheat and can lead to tire failure.

Under-inflation also reduces fuel efficiency and tire tread life, and may affect the vehicle's handling and stopping ability.

Please note that the TPMS is not a substitute for proper tire maintenance, and it is the driver's responsibility to maintain correct tire pressure, even if under-inflation has not reached the level to trigger illumination of the TPMS low tire pressure telltale.

Your vehicle has also been equipped with a TPMS malfunction indicator to indicate when the system is not operating properly. The TPMS malfunction indicator is combined with the low tire pressure telltale. When the system detects a malfunction, the telltale will flash for approximately one minute and then remain continuously illuminated. This sequence will continue upon subsequent vehicle start-ups as long as the malfunction exists.

When the malfunction indicator is illuminated, the system may not be able to detect or signal low tire pressure as telltale. TPMS malfunctions may occur for a variety of reasons, including the installation of replacement or alternate tires or wheels on the vehicle that prevent the TPMS from functioning properly.

Always check the TPMS malfunction telltale after replacing one or more tires or wheels on your vehicle to ensure that the replacement or alternate tires and wheels allow the TPMS to continue to function properly.

### NOTICE

**If any of the below happens, have the system checked by an authorized HYUNDAI dealer.**

- 1. The Low Tire Pressure Telltale/ TPMS Malfunction Indicator does not illuminate for 3 seconds when the ignition switch is placed to the ON position or engine is running.**
- 2. The TPMS Malfunction Indicator remains illuminated after blinking for approximately 1 minute.**
- 3. The Low Tire Pressure Position Telltale remains illuminated.**



## Low Tire Pressure Warning Light

### Low Tire Pressure Position and Tire Pressure Display



When the tire pressure monitoring system warning indicators are illuminated and a warning message displayed on the cluster LCD display, one or more of your tires is significantly under-inflated. The Low Tire Pressure Position Telltale will indicate which tire is significantly underinflated by illuminating the corresponding position light.

If either telltale illuminates, immediately reduce your speed, avoid hard cornering and anticipate increased stopping distances. You should stop and check your tires as soon as possible. Inflate the tires to the proper pressure as indicated on the vehicle's placard or tire inflation pressure label located on the driver's side center pillar outer panel.

If you cannot reach a service station or if the tire cannot hold the newly added air, replace the low pressure tire with the spare tire.

The Low Tire Pressure Telltale will remain on and the TPMS Malfunction Indicator may blink for one minute and then remain illuminated (when the vehicle is driven approximately 10 minutes at speed above 15.5 mph (25 km/h)) until you have the low pressure tire repaired and replaced on the vehicle.



### CAUTION

**In winter or cold weather, the Low Tire Pressure Telltale may be illuminated if the tire pressure was adjusted to the recommended tire inflation pressure in warm weather. It does not mean your TPMS is malfunctioning because the decreased temperature leads to a proportional lowering of tire pressure.**

**When you drive your vehicle from a warm area to a cold area or from a cold area to a warm area, or the outside temperature is greatly higher or lower, you should check the tire inflation pressure and adjust the tires to the recommended tire inflation pressure.**



### WARNING

**Low pressure damage**

**Significantly low tire pressure makes the vehicle unstable and can contribute to loss of vehicle control and increased braking distances.**

**Continued driving on low pressure tires can cause the tires to overheat and fail.**



### TPMS Malfunction Indicator

The TPMS Malfunction Indicator will illuminate after it blinks for approximately one minute when there is a problem with the Tire Pressure Monitoring System.

Have the system checked by an authorized HYUNDAI dealer as soon as possible.

#### **NOTICE**

If there is a malfunction with the TPMS, the individual tire pressures in the cluster LCD display will not be available. Have the system checked by an authorized HYUNDAI dealer as soon as possible.

#### **NOTICE**

The TPMS Malfunction Indicator may illuminate after blinking for one minute if the vehicle is near electric power supply cables or radio transmitters such as police stations, government and public offices, broadcasting stations, military installations, airports, transmitting towers, etc.

Additionally, the TPMS Malfunction Indicator may illuminate if snow chains are used or electronic devices such as computers, chargers, remote starters, navigation, etc. This may interfere with normal operation of the TPMS.

### Changing a Tire with TPMS

If you have a flat tire, the Low Tire Pressure and Position telltales will come on. Have the flat tire repaired by an authorized HYUNDAI dealer as soon as possible or replace the flat tire with the spare tire.

#### **NOTICE**

**It is recommended that you do not use a puncture-repairing agent not approved by HYUNDAI dealer or the equivalent specified for your vehicle to repair and/or inflate a low pressure tire. Tire sealant not approved by HYUNDAI dealer or the equivalent specified for your vehicle may damage the tire pressure sensor.**

The spare tire (if equipped) does not come with a tire pressure monitoring sensor. When the low pressure tire or the flat tire is replaced with the spare tire, the Low Tire Pressure Telltale will remain on. Also, the TPMS Malfunction Indicator will illuminate after blinking for one minute if the vehicle is driven at speed above 15.5 mph (25 km/h) for approximately 10 minutes.

Once the original wheel equipped with a tire pressure monitoring sensor is reinflated to the recommended pressure and reinstalled on the vehicle, the Low Tire Pressure Telltale and TPMS Malfunction Indicator will go off within a few minutes of driving.

If the indicators do not extinguish after a few minutes, please visit an authorized HYUNDAI dealer.

Each wheel is equipped with a tire pressure sensor mounted inside the tire behind the valve stem (except for the spare tire). You must use TPMS specific wheels. It is recommended that you always have your tires serviced by an authorized HYUNDAI dealer.

You may not be able to identify a tire with low pressure by simply looking at it. Always use a good quality tire pressure gauge to measure. Please note that a tire that is hot (from being driven) will have a higher pressure measurement than a tire that is cold.

A cold tire means the vehicle has been sitting for 3 hours and driven for less than 1 mile (1.6 km) in that 3 hour period.

Allow the tire to cool before measuring the inflation pressure. Always be sure the tire is cold before inflating to the recommended pressure.



#### **WARNING**

- **The TPMS cannot alert you to severe and sudden tire damage caused by external factors such as nails or road debris.**
- **If you feel any vehicle instability, immediately take your foot off the accelerator, apply the brakes gradually with light force, and slowly move to a safe position off the road.**



#### **WARNING**

**Tampering with, modifying, or disabling the Tire Pressure Monitoring System (TPMS) components may interfere with the system's ability to warn the driver of low tire pressure conditions and/or TPMS malfunctions. Tampering with, modifying, or disabling the Tire Pressure Monitoring System (TPMS) components may void the warranty for that portion of the vehicle.**



#### **Information**

**This device complies with Part 15 of the FCC rules.**

**Operation is subject to the following three conditions:**

1. **This device may not cause harmful interference.**
2. **This device must accept any interference received, including interference that may cause undesired operation.**
3. **Changes or modifications not expressly approved by the party responsible for compliance could void the user's authority to operate the equipment.**

## IF YOU HAVE A FLAT TIRE

### WARNING

Changing a tire can be dangerous. Follow the instructions in this section when changing a tire to reduce the risk of serious injury or death.

### WARNING

Driving on a flat tire will cause permanent damage to the tire. Re-inflating a tire after it has been driven on while severely underinflated or flat may cause a blowout and a serious crash. Never attempt to re-inflate a tire that has been driven on while severely underinflated or flat. In this case, repair or replace the flat tire as soon as possible.

### CAUTION

Be careful as you use the jack handle to stay clear of the flat end. The flat end has sharp edges that could cause cuts.

## Jack and Tools

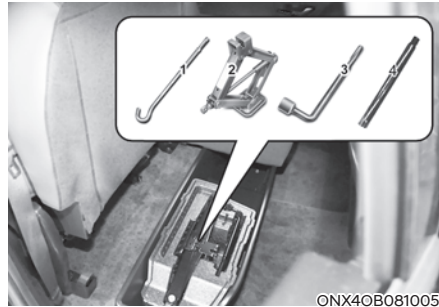

- (1) Jack handle
- (2) Jack
- (3) Wheel nut wrench
- (4) Socket

The jack and wheel lug wrench are stored in storage box under the right rear seat.

The jack and tools for changing the spare tire are located in a foam storage container located underneath the right rear seat inside the vehicle.

The jack and the tools provided are to assist you in changing a spare tire only. To prevent the jack and the tools from rattling around when driving your vehicle, always be sure to store it properly.

Follow the instructions in this manual and use extreme caution when changing a tire in order to reduce the possibility of personal injury.

### **Jacking instructions**

The jack is provided for emergency tire changing only.

- To prevent the jack from rattling while the vehicle is in motion, store it properly.
- Follow jacking instructions to reduce the possibility of personal injury.

## Removing and Storing the Spare Tire

Your spare tire is stored underneath your vehicle, below the pickup bed area.

To remove the spare tire:



1. To easily remove the spare tire cap, insert a coin or a flathead driver and turn counterclockwise as engraved on the cap.



2. Connect the socket and wheel nut wrench.
3. Use the wheel nut wrench to loosen the bolt enough to lower the spare tire.

Turn the wrench counterclockwise until the spare tire reaches the ground.



4. After the spare tire reaches the ground, continue to turn the wrench counterclockwise, and draw the spare tire outside. Never rotate the wrench excessively, otherwise the spare tire carrier may be damaged.
5. Remove the retainer (1) from the center of the spare tire.

To store the spare tire :



1. Lay the tire on the ground with the valve stem facing up.
2. Place the wheel under the vehicle and install the retainer (1) through the wheel center.
3. Turn the wrench clockwise until it clicks.

 **WARNING**

Ensure the spare tire retainer is properly aligned with the center of the spare tire to prevent the spare tire from rattling. Otherwise, it may cause the spare tire to fall off the carrier and lead to an accident.

## Changing Tires

 **WARNING**

A vehicle can slip or roll off of a jack causing serious injury or death to you or those nearby. Take the following safety precautions:

- Do not get under a vehicle that is supported by a jack.
- **NEVER** attempt to change a tire in the lane of traffic. **ALWAYS** move the vehicle completely off the road on level, firm ground away from traffic before trying to change a tire. If you cannot find a level, firm place off the road, call a towing service for assistance.
- Be sure to use the jack provided with the vehicle.
- **ALWAYS** place the jack on the designated jacking positions on the vehicle and **NEVER** on the bumpers or any other part of the vehicle for jacking support.
- Do not start or run the engine while the vehicle is on the jack.
- Do not allow anyone to remain in the vehicle while it is on the jack.
- Keep children away from the road and the vehicle.



**⚠ WARNING****Tire jack**

Do not place any portion of your body under a vehicle that is only supported by a jack since the vehicle can easily roll off the jack. Use vehicle support stands.

**⚠ WARNING****Running vehicle on jack**

- Do not start or run the engine of the vehicle while the vehicle is on the jack as this may cause the vehicle to fall off the jack.
- To prevent the jack from rattling while the vehicle IS in motion, store it properly.

**NOTICE****Retreaded tires**

Possibly substantial variations in the design and age of the tire casing structures can limit service life and have a negative impact on road safety.

Follow these steps to change your vehicle's tire:

1. Park on a level, firm surface.
2. Shift the gear to P (Park), apply the parking brake, and press the Engine Start/Stop button to the OFF position or place the ignition switch in the LOCK/OFF position.
3. Press the hazard warning flasher button.
4. Remove the wheel lug wrench, jack, jack handle, and spare tire from the vehicle.



[A] : Block

5. Block both the front and rear of the tire diagonally opposite of the tire you are changing.



6. Loosen the wheel nuts counterclockwise one turn each in the order shown above, but do not remove any wheel nuts until the tire has been raised off of the ground.



7. Place the jack at the designated jacking position under the frame closest to the tire you are changing. The jacking positions are plates welded to the frame with two notches. Never jack at any other position or part of the vehicle. Doing so may damage the side seal molding or other parts of the vehicle.



8. Insert the jack handle into the jack and turn it clockwise, raising the vehicle until the tire just clears the ground. This measurement is approximately 1.2 inches (30 mm). Before removing the wheel lug nuts, make sure the vehicle is stable and that there is no chance for movement or slippage.
9. Loosen the lug nuts with the wheel lug nut wrench and remove them with your fingers. Remove the wheel from the studs and lay it flat on the ground out of the way. Remove any dirt or debris from the studs, mounting surfaces and wheel.

### **WARNING**

**Wheels may have sharp edges. Handle them carefully to avoid possible severe injury. Before putting the wheel into place, be sure that there is nothing on the hub or wheel (such as mud, tar, gravel, etc.) that interferes with the wheel from fitting solidly against the hub.**

**If there is, remove it. If there is not good contact on the mounting surface between the wheel and hub, the wheel nuts could come loose and cause the loss of a wheel. Loss of a wheel may result in loss of control of the vehicle. This may cause serious injury or death.**

10. Install the spare tire onto the studs of the hub.
11. Tighten the lug nuts with your fingers onto the studs with the smaller end of the lug nuts closest to the wheel.
12. Lower the vehicle to the ground by turning the jack handle counterclockwise.



13. Use the wheel lug wrench to tighten the wheel nuts in the order shown. Double-check each wheel nuts until they are tight. After changing tires, have an authorized HYUNDAI dealer tighten the wheel nuts to their proper torque as soon as possible. **The wheel nuts should be tightened to 79~94 lbf.ft (11~13 kgf.m).**

If you have a tire gauge, check the tire pressure (see “Tires and Wheels” section in chapter 2 for tire pressure instructions.). If the pressure is lower or higher than recommended, drive slowly to the nearest service station and adjust it to the recommended pressure. Always reinstall the valve cap after checking or adjusting tire pressure. If the cap is not replaced, air may leak from the tire. If you lose a valve cap, buy another and install it as soon as possible. After changing tires, secure the flat tire and return the jack and tools to their proper storage locations.

#### NOTICE

**Check the tire pressure as soon as possible after installing a spare tire. Adjust it to the recommended pressure.**



#### CAUTION

**Your vehicle has metric threads on the studs and wheel nuts. Make certain during tire changing that the same nuts that were removed are reinstalled. If you have to replace your wheel nuts make sure they have metric threads to avoid damaging the studs and ensure the wheel is properly secured to the hub. Consult an authorized HYUNDAI dealer for assistance.**



#### WARNING

##### Wheel studs

**If the studs are damaged, they may lose their ability to retain the wheel. This could lead to the loss of the wheel and a collision resulting in serious injuries.**

If any of the equipment such as the jack, wheel nuts, studs, or other equipment is damaged or in poor condition, do not attempt to change the tire and call for assistance.

### **Use of compact spare tires**

Compact spare tires are designed for emergency use only. Drive carefully on the compact spare tire and always follow the safety precautions.



### **WARNING**

To prevent compact spare tire failure and loss of control possibly resulting in an accident:

- Use the compact spare tire only in an emergency.
- **NEVER** operate your vehicle over 50 mph (80 km/h).
- Do not exceed the vehicle's maximum load rating or the load carrying capacity shown on the sidewall of the compact spare tire.
- Do not use the compact spare tire continuously. Repair or replace the original tire as soon as possible to avoid failure of the compact spare tire.

When driving with the compact spare tire mounted to your vehicle:

- Check the tire pressure after installing the compact spare tire. The compact spare tire should be inflated to 60 psi (420 kPa).
- Do not take this vehicle through an automatic car wash while the compact spare tire is installed.
- Do not use the compact spare tire on any other vehicle because this tire has been designed especially for your vehicle.
- The compact spare tire's tread life is shorter than a regular tire. Inspect your compact spare tire regularly and replace worn compact spare tires with the same size and design, mounted on the same wheel.

- Do not use more than one compact spare tire at a time.
- Do not tow a trailer while the compact spare tire is installed.



### **Information**

When the original tire and wheel are repaired and reinstalled on the vehicle, the wheel nuts torque must be set correctly. The correct wheel nuts tightening torque is 79~94 lbf.ft (11~13 kgf.m).

### **NOTICE**

To prevent damaging the compact spare tire and your vehicle:

- Drive slowly enough for the road conditions to avoid all hazards, such as a potholes or debris.
- Avoid driving over obstacles. The compact spare tire diameter is smaller than the diameter of a conventional tire and reduces the ground clearance approximately 1 inch (25 mm).
- Do not use tire chains on the compact spare tire. Because of the smaller size, a tire chain will not fit properly.
- Do not use the compact spare tire on any other wheels, nor should standard tires, snow tires, wheel covers or trim rings be used with the compact spare wheel.

### Storing the Flat Tire

The full size flat tire should be stored and fixed in the vehicle until you reach a service station.

#### **i** Information

**Do not store the flat tire on the spare tire carrier underneath your vehicle.**

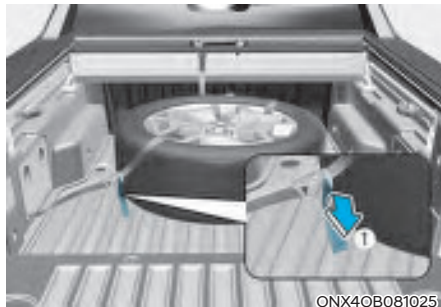

1. Take out the strap which is stored in the storage box under the right rear seat. Connect the two straps with the buckle, if necessary, before using the strap to fix the flat tire.
2. Place the flat tire on the floor of the bed area.
3. Pass one end of the strap through the wheel center and connect both strap hooks to each D-rings (A-A' or B-B').

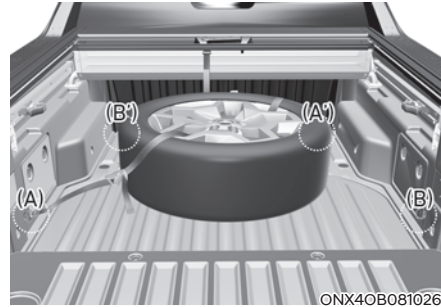

4. Pull the strap (1) to tighten the strap firmly.
5. Try moving the flat tire to see if it is properly secured.

#### **⚠** CAUTION

**Never leave the flat tire unfixed in the vehicle. An unsecured flat tire may cause damage to the vehicle when the vehicle makes sharp turns, suddenly stops, or is in an accident.**

## Jack Label

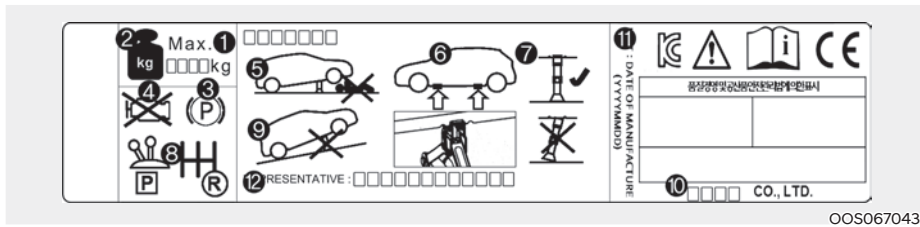

OOS067043

The actual Jack label in the vehicle may differ from the illustration.

For more detailed specifications, refer to the label attached to the jack.

1. Model Name
2. Maximum allowable load
3. When using the jack, set your parking brake.
4. When using the jack, stop the engine.
5. Do not get under a vehicle that is supported by a jack.
6. The designated locations under the frame
7. When supporting the vehicle, the base plate of jack must be vertical under the lifting point.
8. Shift the gear to the P position on vehicles with automatic transmission.
9. The jack should be used on firm level ground.
10. Jack manufacture
11. Production date
12. Representative company and address

## TOWING

### Towing Service

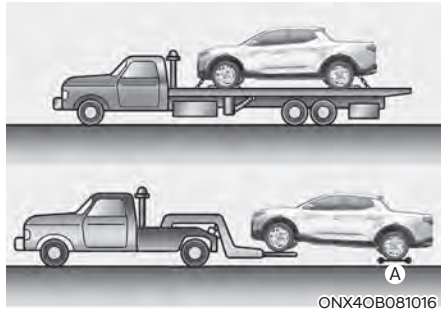

ONX4OB081016

[A] : Dollies

If emergency towing is necessary, we recommend having it done by an authorized HYUNDAI dealer or a commercial tow-truck service.

Proper lifting and towing procedures are necessary to prevent damage to the vehicle. The use of wheel dollies or flatbed is recommended.

For FWD vehicles, it is acceptable to tow the vehicle using a tow truck as long as the front wheels (which are the drive wheels) are off the ground. The rear wheels can be on the ground without the use of dollies.

For AWD vehicles, all wheels must be off the ground. Therefore, a flat bed trailer is recommended.

If any of the loaded wheels or suspension components are damaged or the vehicle is being towed with the rear wheels on the ground, use a towing dolly under the rear wheels.

When being towed by a commercial tow truck and wheel dollies are not used, the front of the vehicle should always be lifted, not the rear.

For AWD vehicles, it must be towed with a wheel lift and dollies or flatbed equipment with all the wheels off the ground.

#### NOTICE

**Do not lift the vehicle by the tow fitting or body and chassis parts. Otherwise the vehicle may be damaged.**



#### CAUTION

- **Do not tow the vehicle with the front wheels on the ground as this may cause damage to the vehicle.**



ONX4OB081017

- **Do not tow with sling-type equipment. Use wheel lift or flatbed equipment.**



ONX4OB081018

## Emergency Situations

---

When towing your vehicle in an emergency without wheel dollies:

1. Release EPB before turning off the engine.
2. Place the ignition switch to the OFF position.
3. Change the gear to N (Neutral) while pressing the brake pedal.
4. Place the ignition switch to the ACC position.



### **CAUTION**

**Failure to shift the gear to N (Neutral) may cause internal damage to the transmission.**



# 9. Maintenance

Engine Compartment .....	9-3
Maintenance Services .....	9-4
Owner's Responsibility .....	9-4
Owner Maintenance Precautions.....	9-4
Owner Maintenance .....	9-5
Owner Maintenance Schedule.....	9-6
Scheduled Maintenance Services .....	9-7
Normal Maintenance Schedule.....	9-8
Maintenance Under Severe Usage Conditions .....	9-12
Explanation of Scheduled Maintenance Items .....	9-14
Fuel Filter .....	9-14
Parking Brake.....	9-16
Engine Oil .....	9-17
Engine Coolant .....	9-20
Checking the Coolant Level.....	9-20
Changing Coolant .....	9-22
Brake Fluid.....	9-23
Checking the Brake Fluid Level.....	9-23
Washer Fluid.....	9-24
Checking the Washer Fluid Level.....	9-24
Air Cleaner .....	9-25
Filter Replacement.....	9-25
Cabin Air Filter.....	9-27
Filter Inspection.....	9-27
Filter Replacement.....	9-27
Wiper Blades .....	9-28
Blade Inspection .....	9-28
Blade Replacement.....	9-28
Battery .....	9-31
For Best Battery Service .....	9-32
Battery Capacity Label.....	9-32
Battery Recharging .....	9-33
Reset Items .....	9-34

---



---

Tires and Wheels.....	9-35
Tire Care.....	9-35
Recommended Cold Tire Inflation Pressures.....	9-35
Check Tire Inflation Pressure.....	9-36
Tire Rotation .....	9-37
Wheel Alignment and Tire Balance.....	9-38
Tire Replacement .....	9-38
Wheel Replacement.....	9-39
Tire Traction .....	9-39
Tire Maintenance.....	9-39
Tire Sidewall Labeling .....	9-40
Tire Terminology and Definitions .....	9-43
All Season Tires.....	9-46
Summer Tires .....	9-46
Low Aspect Ratio Tires.....	9-47
Fuses.....	9-48
Instrument Panel Fuse Replacement.....	9-49
Engine Compartment Panel Fuse Replacement.....	9-50
Fuse/Relay Panel Description.....	9-51
Light Bulbs.....	9-57
Headlamp, Position Lamp, Turn Signal Lamp, Daytime Running Light (DRL) Replacement .....	9-58
Side Repeater Lamp Replacement .....	9-60
Rear Combination Lamp Replacement .....	9-60
High Mounted Stop Lamp and Top Mounted Bed Lamp / Side Mounted Bed Lamp Replacement .....	9-62
License Plate Lamp Replacement.....	9-63
Interior light replacement.....	9-63
Appearance Care .....	9-65
Exterior Care.....	9-65
Interior Care.....	9-70
Emission Control System.....	9-73
California Perchlorate Notice.....	9-76

## ENGINE COMPARTMENT

### ■ Smartstream G2.5 GDI

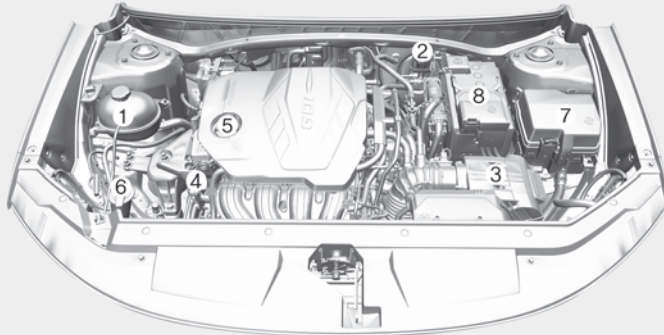

### ■ Smartstream G2.5 TGDl

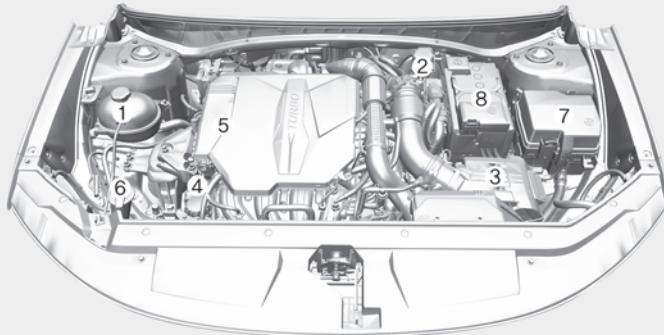

**The actual engine compartment in the vehicle may differ from the illustration.**

ONX4OB091016/ONX4OB091001

- |                             |   |
|-----------------------------|---|
| 1. Engine coolant reservoir | 5. Engine oil filler cap (2.5 T-GDI's filler cap is under the engine cover) |
| 2. Brake fluid reservoir    | 6. Windshield washer fluid reservoir  |
| 3. Air cleaner              | 7. Fuse box   |
| 4. Engine oil dipstick      | 8. Battery  |

## MAINTENANCE SERVICES

You should exercise the utmost care to prevent damage to your vehicle and injury to yourself whenever performing any maintenance or inspection procedures.

We recommend you have your vehicle maintained and repaired by an authorized HYUNDAI dealer. An authorized HYUNDAI dealer meets HYUNDAI's high service quality standards and receives technical support from HYUNDAI in order to provide you with a high level of service satisfaction.

### Owner's Responsibility

Maintenance service and record retention are the owner's responsibility.

You should retain documents that show proper maintenance has been performed on your vehicle in accordance with the scheduled maintenance service charts shown on the following pages. You need this information to establish your compliance with the servicing and maintenance requirements of your vehicle warranties.

Detailed warranty information is provided in your Owner's Handbook & Warranty Information booklet.

Repairs and adjustments required as a result of improper maintenance or a lack of required maintenance are not covered.

### Owner Maintenance Precautions

Inadequate, incomplete or insufficient servicing may result in operational problems with your vehicle that could lead to vehicle damage, an accident, or personal injury. This chapter provides instructions only for the maintenance items that are easy to perform.

Your vehicle should not be modified in any way. Such modifications may adversely affect the performance, safety or durability of your vehicle and may, in addition, violate conditions of the limited warranties covering the vehicle.

#### **NOTICE**

**Improper owner maintenance during the warranty period may affect warranty coverage. For details, read the separate Service Passport provided with the vehicle. If you're unsure about any servicing or maintenance procedure, have it done by an authorized HYUNDAI dealer.**

## OWNER MAINTENANCE



### WARNING

Performing maintenance work on a vehicle can be dangerous. If you lack sufficient knowledge and experience or the proper tools and equipment to do the work, have it done by an authorized HYUNDAI dealer. ALWAYS follow these precautions for performing maintenance work:

- **Park your vehicle on level ground. Shift the vehicle to P (Park), apply the parking brake, and place the ignition switch in the OFF position.**
- **Block the tires (front and back) to prevent the vehicle from moving. Remove loose clothing or jewelry that can become entangled in moving parts.**
- **If you must run the engine during maintenance, do so out doors or in an area with plenty of ventilation.**
- **Keep flames, sparks, or smoking materials away from the battery and fuel-related parts.**



### WARNING

**Touching metal parts**

**Do not touch metal parts (including strut bars) while the engine is operating or hot. Doing so could result in serious personal injury. Turn the engine off and wait until the metal parts cool down to perform maintenance work on the vehicle.**

The following lists are vehicle checks and inspections that should be performed by the owner or an authorized HYUNDAI dealer at the frequencies indicated to help ensure safe, dependable operation of your vehicle.

Any adverse conditions should be brought to the attention of your dealer as soon as possible.

These Owner Maintenance vehicle checks are generally not covered by warranties and you may be charged for labor, parts and lubricants used.

## Owner Maintenance Schedule

### **When you stop for fuel:**

- Check the coolant level in the engine coolant reservoir.
- Check the windshield washer fluid level.
- Check for low or under-inflated tires.



### **WARNING**

**Be careful when checking your coolant level when the engine is hot. This may result in coolant being blown out of the opening and cause serious burns and other injuries.**

### **While operating your vehicle:**

- Note any changes in the sound of the exhaust or any smell of exhaust fumes in the vehicle.
- Check for vibrations in the steering wheel. Notice if there is any increased steering effort or looseness in the steering wheel, or change in its straight-ahead position.
- Notice if your vehicle constantly turns slightly or “pulls” to one side when traveling on smooth, level road.
- When stopping, listen and check for unusual sounds, pulling to one side, increased brake pedal travel or “hard-to-push” brake pedal.
- Check the automatic transmission or dual clutch transmission P (Park) function.
- Check the parking brake.
- Check for fluid leaks under your vehicle (water dripping from the air conditioning system during or after use is normal).

### **At least monthly:**

- Check coolant level in the engine coolant reservoir.
- Check the operation of all exterior lights, including the stoplights, turn signals and hazard warning flashers.
- Check the inflation pressures of all tires including the spare for tires that are worn, show uneven wear, or are damaged.
- Check for loose wheel lug nuts.

### **At least twice a year:**

- Check radiator, heater and air conditioning hoses for leaks or damage.
- Check windshield washer spray and wiper operation. Clean wiper blades with a clean cloth dampened with washer fluid.
- Check headlamp alignment.
- Check muffler, exhaust pipes, shields and clamps.
- Check the seat belts for wear and function.

### **At least once a year:**

- Clean body and door drain holes.
- Lubricate door hinges and hood hinges.
- Lubricate door and hood locks and latches.
- Lubricate door rubber weather strips.
- Check the air conditioning system.
- Inspect and lubricate automatic transmission linkage and controls.
- Clean the battery and terminals.
- Check the brake fluid level.

## SCHEDULED MAINTENANCE SERVICES

Follow Normal Maintenance Schedule if the vehicle is usually operated where none of the following conditions apply. If any of the following conditions apply, you must follow the Maintenance Under Severe Usage Conditions.

- Repeated driving short distance of less than 5 miles (8 km) in normal temperature or less than 10 miles (16 km) in freezing temperature
- Extensive engine idling or low speed driving for long distances
- Driving on rough, dusty, muddy, unpaved, graveled or salt-spread roads
- Driving in areas using salt or other corrosive materials or in very cold weather
- Driving in heavy dust conditions
- Driving in heavy traffic area
- Driving on uphill, downhill, or mountain road repeatedly
- Towing a trailer or using a camper, or driving with loads on the roof
- Driving as a patrol car, taxi, other commercial use of vehicle towing
- Frequently driving under high speed or rapid acceleration/deceleration
- Frequently driving in stop-and-go condition
- Engine oil usage which is not recommended (Mineral type, Semi-synthetic, Lower grade spec, etc.)

If your vehicle is operated under the above conditions, you should inspect, replace or refill more frequently than the following Normal Maintenance Schedule. After the periods or distance shown in the chart, continue to follow the prescribed maintenance intervals.

### **NOTICE**

**After 10 years or 100,000 miles, we recommend to use severe maintenance schedule.**

### **i Information**

- **As it is normal for engine oil to be consumed during driving, the engine oil level should be checked on regular basis.**
- **The engine oil change interval for normal operating conditions is based on the use of the recommended engine specification. If the recommended engine oil specification is not used, then replace the engine oil according to the maintenance schedule under severe operating conditions.**

### Normal Maintenance Schedule

MAINTENANCE INTERVALS	Number of months or driving distance, whichever comes first															
	Months	12	24	36	48	60	72	84	96	108	120	132	144	156		
MAINTENANCE ITEM	Miles*1,000	8	16	24	32	40	48	56	64	72	80	88	96	104		
	Km*1,000	13	26	39	52	65	78	91	104	117	130	143	156	169		
Engine oil and engine oil filter *1		R	R	R	R	R	R	R	R	R	R	R	R	R		
Drive belts *2		At first, inspect at 48,000 miles (78,000 km) or 72 months. Thereafter, inspect every 8,000 miles (13,000 km) or 12 months														
Fuel additives *3		Add every 8,000 miles (13,000 km) or 12 months														

I : Inspect and if necessary, adjust, correct, clean or replace.

R : Replace or change.

\*1: Check the engine oil level and leak every 350miles (500km) or before starting a long trip. As it is normal for engine oil to be consumed during driving, the engine oil level should be checked on regular basis. The engine oil change interval for normal operating conditions is based on the use of the recommended engine specification. If the recommended engine oil specification is not used, then replace the engine oil according to the maintenance schedule under severe operating conditions.

\*2: The drive belt should be replaced when cracks occur or tension is reduced excessively.

\*3: If TOP TIER Detergent Gasoline is not available, one bottle of additive is recommended. Additives are available from your authorized HYUNDAI dealer along with information on how to use them. Do not mix other additives.



## Normal Maintenance Schedule (Cont.)

MAINTENANCE INTERVALS MAINTENANCE ITEM	Number of months or driving distance, whichever comes first														
	Months	12	24	36	48	60	72	84	96	108	120	132	144	156	
Miles×1,000	8	16	24	32	40	48	56	64	72	80	88	96	104		
Km×1,000	13	26	39	52	65	78	91	104	117	130	143	156	169		
Air cleaner filter	I	I	R	I	I	R	I	I	R	I	I	R	I	I	
Spark plugs *4	TGDI					R								R	
	GDI	Replace every 96,000 miles (156,000 km)													
Vapor hose, fuel filler cap and fuel tank		I		I		I		I		I		I		I	
Fuel tank air filter		I		I		I		I		I		I		I	
Fuel lines, hoses and connections		I		I		I		I		I		I		I	
Intercooler in/out hose (only TGDI)		At first, Inspect at 5,000 miles (8,000 km) or 6 months After that, Inspect every 20,000 miles (32,000 km) or 24 months													

I : Inspect and if necessary, adjust, correct, clean or replace.

R : Replace or change.

\*4: For your convenience, it can be replaced prior to it's interval when you do maintenance of other items.

- Fuel filter : The fuel filter is considered to be maintenance free but the quality of fuel used may impact the frequency of maintenance needed. If there are some important safety matters like fuel flow restriction, surging, loss of power, hard starting problem, etc., replace the fuel filter immediately regardless of maintenance schedule and consult an authorized HYUNDAI dealer for details.

**Normal Maintenance Schedule (Cont.)**

MAINTENANCE INTERVALS	Number of months or driving distance, whichever comes first													
	12	24	36	48	60	72	84	96	108	120	132	144	156	
MAINTENANCE ITEM	Months	16	24	32	40	48	56	64	72	80	88	96	104	
	Km×1,000	26	39	52	65	78	91	104	117	130	143	156	169	
Engine coolant		At first, replace at 120,000 miles (200,000 km) or 120 months. After that, replace every 24,000 miles (39,000 km) or 24 months												
Battery condition	I	I	I	I	I	I	I	I	I	I	I	I	I	
Brake lines, hoses and connections	I	I	I	I	I	I	I	I	I	I	I	I	I	
Brake pedal														
Parking brake (if equipped)														
Brake fluid		Inspect every 8,000 miles (13,000 km) or 12 months, Replace every 48,000 miles (78,000 km) or 48 months												

I : Inspect and if necessary, adjust, correct, clean or replace.  
R : Replace or change.

## Normal Maintenance Schedule (Cont.)

MAINTENANCE INTERVALS MAINTENANCE ITEM	Number of months or driving distance, whichever comes first													
	12 Months	24 Months	36 Months	48 Months	60 Months	72 Months	84 Months	96 Months	108 Months	120 Months	132 Months	144 Months	156 Months	
	8 Miles×1,000	16 Miles×1,000	24 Miles×1,000	32 Miles×1,000	40 Miles×1,000	48 Miles×1,000	56 Miles×1,000	64 Miles×1,000	72 Miles×1,000	80 Miles×1,000	88 Miles×1,000	96 Miles×1,000	104 Miles×1,000	
	13 Km×1,000	26 Km×1,000	39 Km×1,000	52 Km×1,000	65 Km×1,000	78 Km×1,000	91 Km×1,000	104 Km×1,000	117 Km×1,000	130 Km×1,000	143 Km×1,000	156 Km×1,000	169 Km×1,000	
Disc brakes and pads	I	I	I	I	I	I	I	I	I	I	I	I	I	
Steering gear rack, linkage and boots		I	I	I	I	I	I	I	I	I	I	I	I	
			TGDI											
		GDI												
Rotate Tires (includes tread wear inspection and tire pressure check)	I	I	I	I	I	I	I	I	I	I	I	I	I	
Suspension mounting bolts	I	I	I	I	I	I	I	I	I	I	I	I	I	
Air conditioner refrigerant	I	I	I	I	I	I	I	I	I	I	I	I	I	
Air conditioner compressor	I	I	I	I	I	I	I	I	I	I	I	I	I	
Cabin air filter														
	Replace every 16,000 miles (25,000 km) or 12 months													
Automatic transmission fluid														
	No check, No service required													
Dual clutch transmission fluid (if equipped)														
Exhaust pipe and muffler	I	I	I	I	I	I	I	I	I	I	I	I	I	
Rear differential oil (AWD) *5														
Transfer case oil (AWD) *5														
Drive shaft														
Propeller shaft (AWD)														

I : Inspect and if necessary, adjust, correct, clean or replace.

R : Replace or change.

\*5 : Rear differential oil / Transfer case oil should be changed anytime, front/rear differential have been submerged in water.

### Maintenance Under Severe Usage Conditions

The following items must be serviced more frequently on cars mainly used under severe driving conditions. Refer to the chart below for the appropriate maintenance intervals.

R : Replace

I : Inspect and if necessary, adjust, correct, clean or replace

Maintenance item	Maintenance operation	Maintenance intervals	Driving condition
Engine oil and engine oil filter* <sup>1</sup>	R	Replace every 5,000 miles (8,000 km) or 6 months	A, B, C, D, E, F, G, H, I, J, K, L
Air cleaner filter	R	Replace more frequently depending on the condition	C, E
Spark plugs	R	Replace more frequently depending on the condition	A, B, F, G, H, I, K
Steering gear box, linkage & boots / lower arm ball joint, upper arm ball joint	I	Inspect more frequently depending on the condition	C, D, E, F, G, H, I
Disc brakes and pads, calipers and rotors	I	Inspect more frequently depending on the condition	C, D, G, H, J, K

**NOTICE**

After 10 years or 100,000 miles, we recommend to use severe maintenance schedule.

Maintenance item	Maintenance operation	Maintenance intervals	Driving condition
Parking brake (if equipped)	I	Inspect more frequently depending on the condition	C, D, G, H
Climate control air filter (for evaporator and blower unit)	R	Replace more frequently depending on the condition	C, E
Automatic transmission fluid	R	Replace every 60,000 miles (96,000 km)	A, C, E, F, G, H, I, K
Dual clutch transmission fluid (if equipped)	R	Replace every 56,000 miles (91,000 km)	A, C, D, E, F, G, H, I, J, K
Rear differential oil (AWD)	R	Replace every 72,000 miles (120,000 km)	C, D, E, G, H, I, J
Transfer case oil (AWD)	R	Replace every 72,000 miles (120,000 km)	C, D, E, G, H, I, J
Drive shaft	I	Inspect more frequently depending on the condition	C, D, E, F, G, H, I
Propeller shaft	I	Inspect more frequently depending on the condition	C, D, E, F, G, H, I

#### **Severe driving conditions**

- A. Repeatedly driving short distance of less than 5 miles (8 km) in normal temperature or less than 10 miles (16 km) in freezing temperature
- B. Extensive engine idling or low speed driving for long distances
- C. Driving on rough, dusty, muddy, unpaved, graveled or saltspread roads
- D. Driving in areas using salt or other corrosive materials or in very cold weather
- E. Driving in the condition of inflowing sand or dust into engine
- F. Driving in heavy traffic area
- G. Driving on uphill, downhill, or mountain roads
- H. Towing a trailer or using a camper, or driving with loads on the roof
- I. Driving for patrol car, taxi, commercial car or vehicle towing
- J. Frequently driving under high speed or rapid acceleration/deceleration
- K. Frequently driving in stop-and-go conditions
- L. Engine oil usage which is not recommended (Mineral type, Semi-synthetic, Lower grade spec, etc.)

## EXPLANATION OF SCHEDULED MAINTENANCE ITEMS

### Engine Oil and Filter

The engine oil and filter should be changed at the intervals specified in the maintenance schedule. If the vehicle is being driven in severe conditions, more frequent oil and filter changes are required.

### Drive Belts

Inspect all drive belts for evidence of cuts, cracks, excessive wear or oil saturation and replace if necessary.

Drive belts should be checked periodically for proper tension and adjusted as necessary.



### Information

**When you are inspecting the belt, turn the engine off.**

### Fuel Lines, Fuel Hoses and Connections

Check the fuel lines, fuel hoses and connections for leakage and damage. We recommend an authorized HYUNDAI dealer replace any damaged or leaking parts immediately.

### Fuel Filter

The fuel filter is considered to be maintenance free but periodic inspection is recommended for this maintenance depends on fuel quality. If there are some important matters like fuel flow restriction, surging, loss of power, hard starting problem etc., replace the fuel filter immediately. Consult an authorized HYUNDAI dealer for details.

### Vapor Hose and Fuel Filler Cap

The vapor hose and fuel filler cap should be inspected at those intervals specified in the maintenance schedule. Your HYUNDAI dealer will help to determine if replacement is needed.

### Vacuum Crankcase Ventilation Hoses

Inspect the surface of hoses for evidence of heat and/or mechanical damage. Hard and brittle rubber, cracking, tears, cuts, abrasions, and excessive swelling indicate deterioration. Particular attention should be paid to examine those hose surfaces nearest to high heat sources, such as the exhaust manifold.

Inspect the hose routing to ensure that the hoses do not come in contact with any heat source, sharp edges or moving component which might cause heat damage or mechanical wear. Inspect all hose connections, such as clamps and couplings, to make sure they are secure, and that no leaks are present. Hoses should be replaced immediately if there is any evidence of deterioration or damage.

### Air Cleaner Filter

We recommend that the air cleaner filter be replaced by an authorized HYUNDAI dealer.

### Spark Plugs

Make sure to install new spark plugs of the correct heat range.

When installing new spark plugs, be sure that the ignition coils are clean and free of any oil or debris. Clean and wipe off the bottom portion of the ignition coil in order to prevent any contamination with the spark plug during installation.



#### **WARNING**

**Do not remove spark plugs from the vehicle when the engine is hot. You may damage the engine and may also risk burn injury.**

### Cooling System

Check cooling system components, such as radiator, coolant reservoir, hoses and connections for leakage and damage. Replace any damaged parts.

### Engine Coolant

The coolant should be changed at the intervals specified in the maintenance schedule.

### Automatic Transmission Fluid

The automatic transmission fluid level does not need to be checked under normal usage conditions.

We recommend that the automatic transmission fluid be changed by an authorized HYUNDAI dealer according to the maintenance schedule.



#### **Information**

**Automatic transmission fluid color is red when new.**

**As the vehicle is driven, the automatic transmission fluid will begin to look darker.**

**This is a normal condition. It does not need to be replaced based on the color change.**

#### **NOTICE**

**The use of a non-specified fluid could result in transmission malfunction and failure.**

**Use only specified automatic transmission fluid. (Refer to “Recommended Lubricants and Capacities” section in chapter 2.)**

### Dual clutch transmission fluid (if equipped)

Inspect the dual clutch transmission fluid according to the maintenance schedule.

### **Brake Hoses and Lines**

Visually check for proper installation, chafing, cracks, deterioration and any leakage. Replace any deteriorated or damaged parts immediately.

### **Brake Fluid**

Check the brake fluid level in the brake fluid reservoir. The level should be between the MIN and the MAX marks on the side of the reservoir. Use only hydraulic brake fluid conforming to DOT 4 specification.

### **Parking Brake**

Inspect the parking brake system including the parking brake button and cables.

### **Brake Discs, Pads, Calipers and Rotors**

Check the pads, the disc, and the rotor for any excessive wear-out. Inspect calipers for any fluid leakage.

For more information on checking the pads or lining wear limit, refer to the HYUNDAI web site.

<http://service.hyundai-motor.com>

### **Drive Shaft and Related**

Check the drive shaft, boots, clamps, rubber couplings and center-bearing rubber for cracks, deterioration, or damage. Replace any damaged parts and if necessary, repack the grease.

### **Suspension Mounting Bolts**

Check the suspension connections for looseness or damage. Retighten to the specified torque.

### **Steering Gear Box, Linkage & Boots/Lower Arm Ball Joint**

With the vehicle stopped and the engine off, check for excessive free-play in the steering wheel. Check the linkage for bends or damage. Check the dust boots and ball joints for deterioration, cracks, or damage.

Replace any damaged parts.

### **Air Conditioning Refrigerant**

Check the air conditioning lines and connections for leakage and damage.



## ENGINE OIL

### Checking the Engine Oil Level

Engine oil is used for lubricating, cooling, and operating various hydraulic components in the engine. Engine oil consumption while driving is normal, and it is necessary to check and refill the engine oil regularly. Also, check and refill the oil level within the recommended maintenance schedule to prevent deterioration of oil performance.

Check the engine oil following the below procedure.

#### **Gasoline engine**

1. Follow all of the oil manufacturer's precautions.
2. Be sure the vehicle is on the level ground in P (Park) with the parking brake set and the wheels blocked.
3. Turn the engine on and warm the engine up until the coolant temperature reaches a constant normal temperature.
4. Turn the engine off, remove the oil filler cap and pull the dipstick out. Wait for 15 minutes for the oil to return to the oil pan.
5. Wipe the dipstick clean and re-insert it fully.

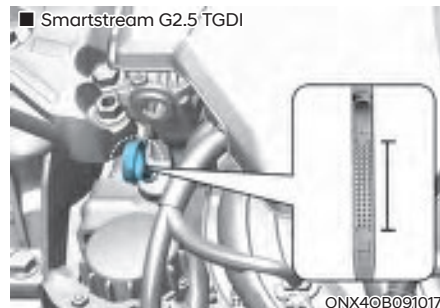
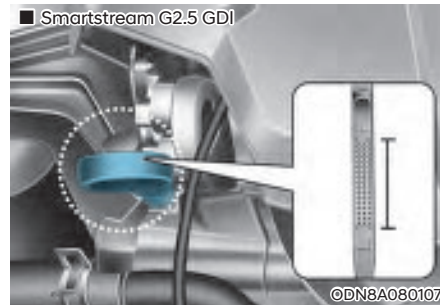

6. Pull the dipstick out again and check the level. The level should be between F (Full) and L (Low).



7. If the oil level is below the L, add enough oil to bring the level to F.

Use only the specified engine oil (Refer to “Recommended Lubricants and Capacities” section in chapter 2).

### **NOTICE**

**To prevent damage to your engine:**

- **Do not spill engine oil when adding or changing engine oil. Wipe off spilled oil immediately.**
- **The engine oil consumption may increase while you break in a new vehicle and it will be stabilized after driving 4,000 miles (6,000 km).**
- **The engine oil consumption can be affected by driving habits, climate conditions, traffic conditions, oil quality, etc. Therefore, it is recommended that you inspect the engine oil level regularly and refill it if necessary.**

### **Checking the Engine Oil and Filter**

- Have engine oil and filter changed by an authorized HYUNDAI dealer according to the Maintenance Schedule at the beginning of this chapter.
- If the maintenance schedule to replace engine oil is exceeded, the engine oil performance may deteriorate, and the engine condition may be affected. Therefore, replace the engine oil according to the maintenance schedule.
- To keep the engine in optimal condition, use the recommended engine oil and filter. If the recommended engine oil and filter are not used, replace it according to the maintenance schedule under severe usage conditions.
- The purpose of the maintenance schedule for engine oil replacement is to prevent oil deterioration and it is irrelevant to oil consumption. Check and refill engine oil regularly.

 **Information**

When the oil pressure is low due to insufficient engine oil, the Engine Oil Pressure (🛢️) warning light will illuminate. In addition, the enhanced engine protection system, which limits the engine's power is activated and the Malfunction Indicator Lamp (🚗) will illuminate when the vehicle is driven in this state continuously. When oil pressure is restored, the Engine Oil Pressure warning light will turn off and the engine power will no longer be limited. However, for gasoline 2.5 GDI engine and 2.5 turbo engine, when the oil pressure is restored, the warning light and the enhanced engine protection system will turn off after the engine is restarted.

**CAUTION**

The engine oil is very hot immediately after the vehicle has been driven and can cause burns during replacement. Replace the engine oil after the engine oil has cooled down.

**WARNING****CALIFORNIA PROPOSITION 65  
WARNING**

Engine oil contains chemicals known to the State of California to cause cancer, birth defects and reproductive harm. Used engine oil may cause irritation or cancer of the skin if left in contact with the skin for prolonged periods of time. Always protect your skin by washing your hands thoroughly with soap and warm water as soon as possible after handling used oil.

## ENGINE COOLANT

The high-pressure cooling system has a reservoir filled with year-round antifreeze coolant. The reservoir is filled at the factory.

Check the antifreeze protection and coolant level at least once a year, at the beginning of the winter season and before traveling to a colder climate.

### Checking the Coolant Level

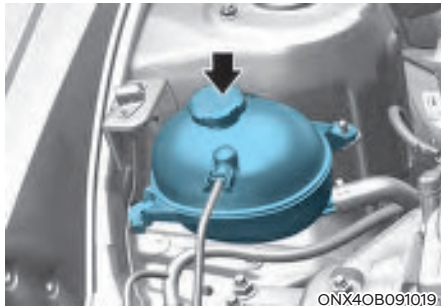

Check the condition and connections of all cooling system hoses and heater hoses. Replace any swollen or deteriorated hoses.

The coolant level should be filled between the MAX and the MIN marks on the side of the coolant reservoir when the engine is cool.

If the coolant level is low, add enough distilled (deionized) water to bring the level to the MAX mark, but do not overfill. If frequent additions are required, see an authorized HYUNDAI dealer for a cooling system inspection.

### WARNING



Never remove the engine coolant cap and/or water-cooled intercooler coolant cap or the drain plug while the engine and radiator are hot. Hot coolant and steam may blow out under pressure, causing serious injury.

Turn the vehicle off and wait until the engine cools down. Use extreme care when removing the engine coolant cap. Wrap a thick towel around it, and turn it counterclockwise slowly to the first stop. Step back while the pressure is released from the cooling system. When you are sure all the pressure has been released, press down on the cap, using a thick towel, and continue turning counterclockwise to remove it.

### Information

The coolant level is influenced by the engine temperature. Before checking or refilling the coolant, turn the engine off.

**⚠ WARNING**

The electric motor for the cooling fan may continue to operate or start up when the engine is not running and can cause serious injury. Keep hands, clothing and tools away from the rotating fan blades of the cooling fan. Always turn off the vehicle unless the vehicle has to be inspected with the engine on. Be cautious as the cooling fan may operate if the negative (-) battery terminal is not disconnected.

**⚠ WARNING**

Make sure the coolant cap is properly closed after refilling coolant. Otherwise the engine could be overheated while driving.

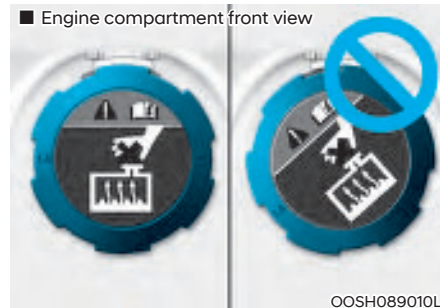

1. Check if the coolant cap label is straight in front.



2. Make sure that the tiny protrusions inside the coolant cap is securely interlocked.

### Recommended coolant

- When adding coolant, use only deionized water, distilled water or soft water for your vehicle and never mix hard water in the coolant filled at the factory.
- An incorrect coolant mixture can result in severe malfunction or engine damage.
- The engine in your vehicle has aluminum engine parts and must be protected by a phosphate-based ethylene glycol coolant to prevent corrosion and freezing.
- Do not use alcohol or methanol coolant or mix them with the specified coolant.
- Do not use a solution that contains more than 60% antifreeze or less than 35% antifreeze, which would reduce the effectiveness of the solution.

For mixing percentage, refer to the following table:

Ambient Temperature	Mixture Percentage (volume)	
	Antifreeze	Water
5°F (-15°C)	35	65
-13°F (-25°C)	40	60
-31°F (-35°C)	50	50
-49°F (-45°C)	60	40

### Information

If in doubt about the mix ratio, a 50% water and 50% antifreeze mix is the easiest to mix together as it will be the same quantity of each. It is suitable to use for most temperature ranges of -31°F (-35°C) and higher.

### Changing Coolant

Have coolant changed by an authorized HYUNDAI dealer according to the Maintenance Schedule at the beginning of this chapter.



#### WARNING

**Do not use engine coolant or antifreeze in the washer fluid reservoir.**

**Engine coolant can severely obscure visibility when sprayed on the windshield and may cause loss of vehicle control resulting in an accident.**

**Engine coolant may also cause damage to paint and body trim.**

#### NOTICE

**To prevent damage to engine parts, put a thick towel around the engine coolant cap and/or inverter coolant cap before refilling the coolant to prevent the coolant from overflowing into engine parts, such as the alternator.**

## BRAKE FLUID

### Checking the Brake Fluid Level

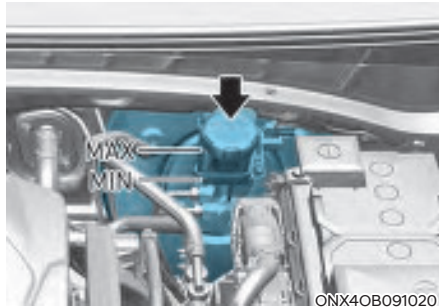

Check the fluid level in the reservoir periodically. The fluid level should be between MAX and MIN marks on the side of the reservoir.

Before removing the reservoir cap and adding brake fluid, clean the area around the reservoir cap thoroughly to prevent brake fluid contamination.

If the level is low, add the specified brake fluid to the MAX level. The level will fall with accumulated mileage. This is a normal condition associated with the wear of the brake linings. If the fluid level is excessively low, have the brake system be checked by an authorized HYUNDAI dealer.



#### WARNING

If the brake system requires frequent additions of fluid this could indicate a leak in the brake system. Have that the vehicle be inspected by an authorized HYUNDAI dealer.



#### WARNING

Do not allow brake fluid to come in contact with your eyes. If brake fluid comes in contact with your eyes, flush your eyes with clean water for at least 15 minutes and get immediate medical attention.

#### NOTICE

- Do not allow brake fluid to contact the vehicle's body paint, as paint damage will result.
- Brake fluid, which has been exposed to open air for an extended time should NEVER be used as its quality cannot be guaranteed. It should be disposed of properly.
- Do not use the wrong kind of brake fluid. A few drops of mineral based oil, such as engine oil, in your brake system can damage brake system parts.



#### Information

Use only the specified brake fluid (refer to "Recommended Lubricants and Capacities" section in chapter 2).

## WASHER FLUID

### Checking the Washer Fluid Level

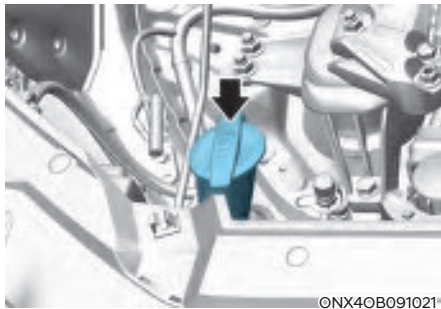

Check the fluid level in the washer fluid reservoir and add fluid if necessary. Plain water may be used during summer months if washer fluid is not available. However, use washer solvent with antifreeze characteristics in cold climates to prevent freezing.

### **WARNING**

To prevent serious injury or death, take the following safety precautions when using washer fluid:

- Do not use engine coolant or antifreeze in the washer fluid reservoir. Engine coolant can severely obscure visibility when sprayed on the windshield and may cause loss of vehicle control resulting in an accident or damage to paint and body trim.
- Do not allow sparks or flame to contact the washer fluid or the washer fluid reservoir. Washer fluid may contain alcohol and can be flammable.
- Do not drink washer fluid and avoid contact with skin. Washer fluid is harmful to humans and animals.
- Keep washer fluid away from children and animals.



## AIR CLEANER

### Filter Replacement

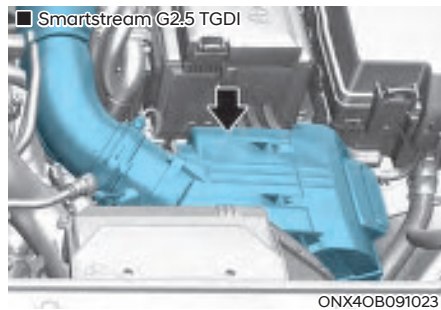
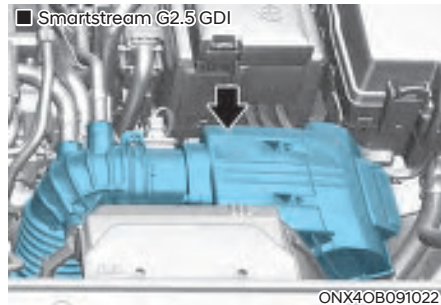

The air cleaner filter can be cleaned for inspection using compressed air. Do not attempt to wash or to rinse it, as water will damage the filter. If soiled, the air cleaner filter must be replaced.



1. Pull up the air cleaner filter cover (1).



2. Pull down the lever to the UNLOCK (2) position.



3. Replace the air cleaner filter.
4. Reassemble the air cleaner cover in the reverse order.

### **i** Information

If the vehicle is operated in extremely dusty or sandy areas, replace the element more often than the usual recommended intervals (refer to “Maintenance Under Severe Usage Conditions” in this chapter).

### **NOTICE**

- Do not drive with the air cleaner filter removed. This will result in excessive engine wear.
- When removing the air cleaner filter, be careful that dust or dirt does not enter the air intake, or damage may result.
- Use HYUNDAI genuine parts or the equivalent specified for your vehicle. Use of non-genuine parts could damage the air flow sensor.

## CABIN AIR FILTER

### Filter Inspection

The cabin air filter should be replaced according to the Maintenance Schedule. If the vehicle is operated in severely air-polluted cities or on dusty rough roads for a long period, it should be inspected more frequently and replaced sooner. Replace the cabin air filter by following the procedure below and be careful to avoid damaging other components.

### Filter Replacement

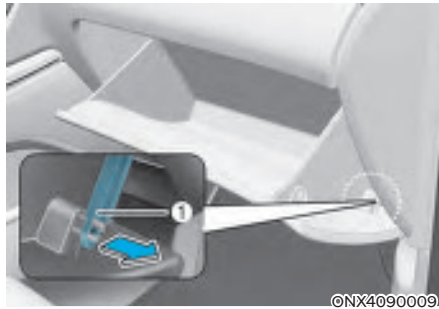

1. Open the glove box and remove the support rod (1).



2. Push in both sides of the glove box as shown. This will ensure that the glove box stopper pins will get released from its holding location allowing the glove box to hang.

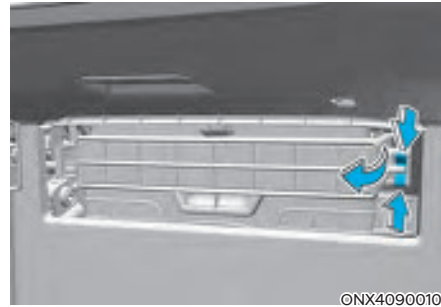

3. Press and hold the lock on the right side of the cover.
4. Pull out the cover.
5. Replace the cabin air filter.
6. Reassemble in the reverse order of disassembly.

### NOTICE

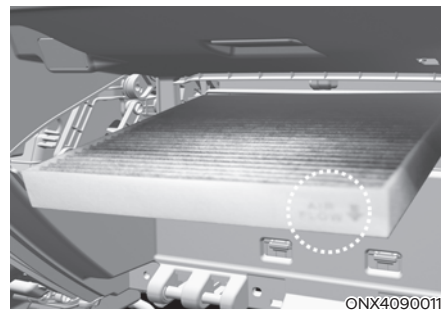

**Install a new cabin air filter in the correct direction with the arrow symbol (↕) facing downwards, to prevent noise and improve effectiveness.**

## WIPER BLADES

### Blade Inspection

Contamination of either the windshield or the wiper blades with foreign matter can reduce the effectiveness of the windshield wipers.

Common sources of contamination are insects, tree sap, and hot wax treatments used by some commercial car washes. If the blades are not wiping properly, clean both the window and the blades with a good cleaner or mild detergent, and rinse thoroughly with clean water.

#### **NOTICE**

To prevent damage to the wiper blades, arms or other components, do not:

- Use gasoline, kerosene, paint thinner, or other solvents on or near them.
- Attempt to move the wipers manually.
- Use non-specified wiper blades.

#### **i** Information

Commercial hot waxes applied by automatic car washes have been known to make the windshield difficult to clean.

#### **i** Information

Wiper blades are consumable items. Normal wear of the wipers may not be covered by your vehicle warranty.

### Blade Replacement

When the wipers no longer clean adequately, the blades may be worn or cracked, and require replacement.

#### **NOTICE**

- In order to prevent damage to the hood and the wiper arms, the wiper arms should only be lifted when in the top wiping position.
- Always return the wiper arms to the windshield before driving.

### Front windshield wiper service positions



This vehicle has a “hidden” wiper design which means that the wipers cannot be lifted when they are in their bottom resting position.

1. Within 20 seconds of turning off the engine, lift and hold the wiper lever up to the MIST position for about 2 seconds until the wipers move to the top wipe position.
2. At this time you can lift the wipers off the windshield.
3. Gently put the wipers back down onto the windshield.
4. Turn the wipers to any ON position to return the wipers to the bottom resting position.

### Type A

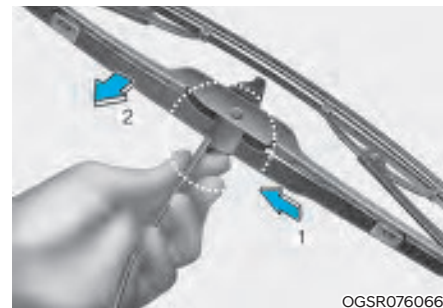

1. Lift up the wiper blade clip. Then lift up the wiper blade.
2. While pushing the lock (1), pull down the wiper blade (2).



3. Remove the wiper blade from the wiper arm.
4. Install a new wiper blade assembly in the reverse order of removal.
5. Return the wiper arm on the windshield.

**Type B**



1. Raise the wiper arm.

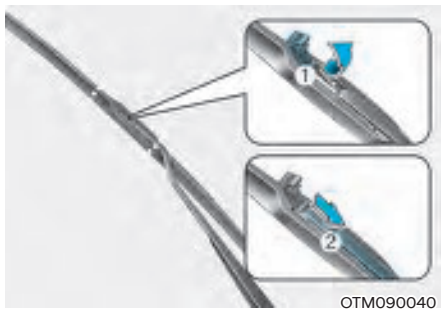

2. Lift up the wiper blade clip. Then pull down the blade assembly and remove it.

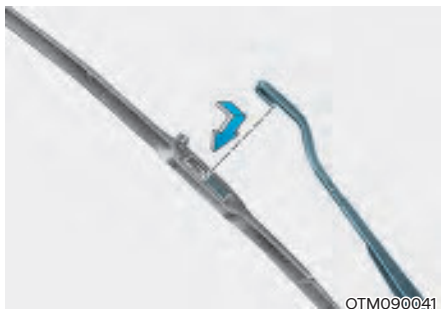

3. Install the new blade assembly in the reverse order of removal.  
4. Return the wiper arm on the windshield.

**⚠ CAUTION**

If the wiper arm receives too much force while pulling the blade, the center part may be damaged.

**⚠ CAUTION**

- The wiper could not operate for approx. 10 seconds when the wiper is operated without washer fluid or the blades are frozen. This is not a malfunction, it is a wiper protection system activated by motor overload circuit within the wiper motor.
- The front windshield should be cleaned with water hose and wiped with clean towel with wiper blades raised up. Also, the wiper blades should be wiped clean when the grease or wax is applied to the blades.

## BATTERY



### WARNING

To prevent **SERIOUS INJURY** or **DEATH** to you or bystanders, always follow these precautions when working near or handling the battery:



Always read and follow instructions carefully when handling a battery.



Wear eye protection designed to protect the eyes from acid splashes.



Keep all flames, sparks, or smoking materials away from the battery.



Hydrogen is always present in battery cells, is highly combustible, and may explode if ignited.



Keep batteries out of reach of children.



Batteries contain sulfuric acid which is highly corrosive. Do not allow acid to contact your eyes, skin or clothing.

If acid gets into your eyes, flush your eyes with clean water for at least 15 minutes and get immediate medical attention. If acid gets on your skin, thoroughly wash the area. If you feel pain or a burning sensation, get medical attention immediately.

- When lifting a plastic-cased battery, excessive pressure on the case may cause battery acid to leak. Lift with a battery carrier or with your hands on opposite corners.
- Do not attempt to jump start your vehicle if your battery is frozen.
- **NEVER** attempt to recharge the battery when the vehicle's battery cables are connected to the battery.
- The electrical ignition system works with high voltage. **NEVER** touch these components with the engine running or when the ignition switch is in the ON position.



### WARNING

#### CALIFORNIA PROPOSITION 65 WARNING

Battery posts, terminals, and related accessories contain lead and lead compounds, chemicals known to the State of California to cause cancer, birth defects and reproductive harm. Batteries also contain other chemicals known to the State of California to cause cancer. Wash hands after handling.

### NOTICE

- When you do not use the vehicle for a long time in a low temperature area, disconnect the battery and keep it indoors.
- Always charge the battery fully to prevent battery case damage in low temperature areas.

### NOTICE

If you connect unauthorized electronic devices to the battery, the battery may be discharged. Never use unauthorized devices.

### For Best Battery Service

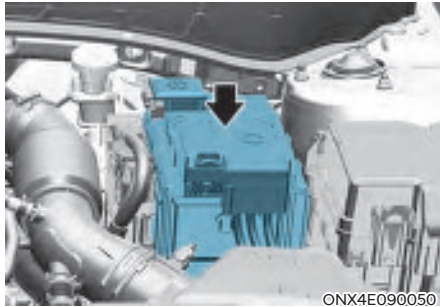

- Keep the battery securely mounted.
- Keep the battery top clean and dry.
- Keep the terminals and connections clean, tight, and coated with petroleum jelly or terminal grease.
- Rinse any spilled electrolyte from the battery immediately with a solution of water and baking soda.
- If the vehicle is not going to be used for an extended time, disconnect the battery cables.

### Battery Capacity Label

■ Type A

■ Type B

1. MF68L-DIN : The HYUNDAI model name of battery
2. 12V : The nominal voltage
3. 68Ah (20HR) : The nominal capacity (in Ampere hours)
4. RC 110min : The nominal capacity (in Ampere hours)
5. 600A : The cold-test current in amperes by SAE/EN



## Battery Recharging

### By battery charger

Your vehicle has a maintenance-free, calcium-based battery.

- If the battery becomes discharged over a short time (because, for example, the headlamps or interior lights were left on while the vehicle was not in use), recharge it by slow charging (trickle) for 10 hours.
- If the battery gradually discharges because of high electrical load while the vehicle is being used, recharge it at 20-30A for two hours.



### WARNING

Always follow these instructions when recharging your vehicle's battery to avoid the risk of **SERIOUS INJURY** or **DEATH** from explosions or acid burns:

- Before performing maintenance or recharging the battery, turn off all accessories and stop the engine.
- Keep all flames, sparks, or smoking materials away from the battery.
- Always work outdoors or in an area with plenty of ventilation.
- Wear eye protection when checking the battery during charging.
- The battery must be removed from the vehicle and placed in a well ventilated area.
- Watch the battery during charging, and stop or reduce the charging rate if the battery cells begin boiling violently.

- The negative battery cable must be removed first and installed last when the battery is disconnected. Disconnect the battery charger in the following order:

1. Turn off the battery charger main switch.
2. Unhook the negative clamp from the negative battery terminal.
3. Unhook the positive clamp from the positive battery terminal.

- Use batteries for replacement from an authorized HYUNDAI dealer.

### NOTICE

AGM battery (if equipped)

- Absorbent Glass Matt (AGM) batteries are maintenance-free and we recommend that the AGM battery be serviced by an authorized HYUNDAI dealer. For charging your AGM battery, use only fully automatic battery chargers that are specially developed for AGM batteries.
- When replacing the AGM battery, use parts for replacement from an authorized HYUNDAI dealer.
- Do not open or remove the cap on top of the battery. This may cause leaks of internal electrolyte that could result in severe injury.

### ***By jump starting***

After a jump start from a good battery, drive the vehicle for 20-30 minutes before it is shutoff. The vehicle may not restart if you shut it off before the battery had a chance to adequately recharge. See “Jump Starting” in chapter 8 for more information on jump starting procedures.



### **Information**



**An inappropriately disposed battery can be harmful to the environment and human health. Dispose of the battery according to your local law(s) or regulation.**

### **Reset Items**

The following items may need to be reset after the battery has been discharged or the battery has been disconnected.

- Auto up/down window (see chapter 5)
- Sunroof (see chapter 5)
- Trip computer (see chapter 5)
- Climate control system (see chapter 5)
- Infotainment system (see infotainment system manual)

## TIRES AND WHEELS



### WARNING

Tire failure may cause loss of vehicle control resulting in an accident. To reduce risk of **SERIOUS INJURY** or **DEATH**, take the following precautions:

- Inspect your tires monthly for proper inflation as well as wear and damage.
- The recommended cold tire pressure for your vehicle can be found in this manual and on the tire label located on the driver's side center pillar. Always use a tire pressure gauge to measure tire pressure. Tires with too much or too little pressure wear unevenly causing poor handling.
- Check the pressure of the spare every time you check the pressure of the other tires on your vehicle.
- Replace tires that are worn, show uneven wear, or are damaged. Worn tires can cause loss of braking effectiveness, steering control, or traction.
- **ALWAYS** replace tires with the same size, type, construction and tread pattern as each tire that was originally supplied with this vehicle. Using tires and wheels other than the recommended sizes could cause unusual handling characteristics, poor vehicle control, or negatively affect your vehicle's Anti-Lock Brake System (ABS) resulting in a serious accident.

### Tire Care

For proper maintenance, safety, and maximum fuel economy, you must always maintain recommended tire inflation pressures and stay within the load limits and weight distribution recommended for your vehicle.



All specifications (sizes and pressures) can be found on a label attached to the driver's side center pillar.

### Recommended Cold Tire Inflation Pressures

All tire pressures (including the spare) should be checked when the tires are cold. "Cold tires" means the vehicle has not been driven for at least three hours or driven less than 1 mile (1.6km).

Warm tires normally exceed recommended cold tire pressures by 4 to 6 psi (28 to 41 kPa). Do not release air from warm tires to adjust the pressure or the tires will be under-inflated. For recommended inflation pressure, refer to "Tire and Wheels" section in chapter 2.



### **WARNING**

**Recommended pressures must be maintained for the best ride, vehicle handling, and minimum tire wear.**

**Over-inflation or under-inflation can reduce tire life, adversely affect vehicle handling, and lead to sudden tire failure that could result in loss of vehicle control resulting in an accident.**

**Severe under-inflation can lead to severe heat build-up, causing blowouts, tread separation and other tire failures that can result in the loss of vehicle control resulting in an accident. This risk is much higher on hot days and when driving for long periods at high speeds.**



### **CAUTION**

- **Under-inflation results in excessive wear, poor handling and reduced fuel economy. Wheel deformation is also possible. Keep your tire pressures at the proper levels. If a tire frequently needs refilling, have it checked by an authorized HYUNDAI dealer.**
- **Over-inflation produces a harsh ride, excessive wear at the center of the tire tread, and a greater possibility of damage from road hazards.**

### **Check Tire Inflation Pressure**

Check your tires, including the spare tire, once a month or more.

#### ***How to check***

Use a good quality tire pressure gauge to check tire pressure. You can not tell if your tires are properly inflated simply by looking at them. Radial tires may look properly inflated when they are under-inflated.

Remove the valve cap from the tire valve stem. Press the tire gauge firmly onto the valve to get a pressure measurement. If the cold tire inflation pressure matches the recommended pressure on the tire and loading information label, no further adjustment is necessary. If the pressure is low, add air until you reach the recommended pressure. Make sure to put the valve caps back on the valve stems. Without the valve cap, dirt or moisture could get into the valve core and cause air leakage. If a valve cap is missing, install a new one as soon as possible.

If you overfill the tire, release air by pushing on the metal stem in the center of the tire valve. Recheck the tire pressure with the tire gauge. Be sure to put the valve caps back on the valve stems. Without the valve cap, dirt or moisture could get into the valve core and cause air leakage. If a valve cap is missing, install a new one as soon as possible.

### Tire Rotation

To equalize tread wear, HYUNDAI recommends that the tires be rotated according to the maintenance schedule or sooner if irregular wear develops.

During rotation, check the tires for correct balance.

When rotating tires, check for uneven wear and damage. Abnormal wear is usually caused by incorrect tire pressure, improper wheel alignment, out-of-balance wheels, severe braking or severe cornering. Look for bumps or bulges in the tread or side of the tire. Replace the tire if you find any of these conditions. Replace the tire if fabric or cord is visible. After rotation, be sure to bring the front and rear tire pressures to specification and check wheel bolt tightness (proper torque is 79.6-94.0 lbf.ft [11.0-13.0 kgf.m]).

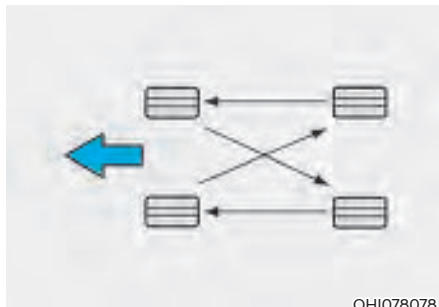

Disc brake pads should be inspected for wear whenever tires are rotated.

### **i** Information

The outside and inside of the unsymmetrical tire is distinguishable. When installing an unsymmetrical tire, be sure to install the side marked “outside” face the outside. If the side marked “inside” is installed on the outside, it will have a negative effect on vehicle performance.

### **!** WARNING

- Do not use the compact spare tire for tire rotation.
- Do not mix bias ply and radial ply tires under any circumstances. This may cause unusual handling characteristics that may cause loss of vehicle control resulting in an accident.

### Wheel Alignment and Tire Balance

The wheels on your vehicle were aligned and balanced carefully at the factory to give you the longest tire life and best overall performance.

In most cases, you will not need to have your wheels aligned again. However, if you notice unusual tire wear or your vehicle pulling one way or the other, the alignment may need to be reset.

If you notice your vehicle vibrating when driving on a smooth road, your wheels may need to be rebalanced.

#### **NOTICE**

**Incorrect wheel weights can damage your vehicle's aluminum wheels. Use only approved wheel weights.**

### Tire Replacement



If the tire is worn evenly, a tread wear indicator will appear as a solid band across the tread. This shows there is less than 1/16 inch (1.6mm) of tread left on the tire. Replace the tire when this happens.

Do not wait for the band to appear across the entire tread before replacing the tire.

#### **WARNING**

**To reduce the risk of DEATH or SERIOUS INJURY:**

- **Replace tires that are worn, show uneven wear, or are damaged. Worn tires can cause loss of braking effectiveness, steering control, and traction.**
- **Always replace tires with the same size as each tire that was originally supplied with this vehicle. Using tires and wheels other than the recommended sizes could cause unusual handling characteristics, poor vehicle control, or negatively affect your vehicle's Anti-Lock Brake System (ABS) resulting in a serious accident.**
- **When replacing tires (or wheels), it is recommended to replace the two front or two rear tires (or wheels) as a pair. Replacing just one tire can seriously affect your vehicle's handling.**
- **Tires degrade over time, even when they are not being used. Regardless of the remaining tread, HYUNDAI recommends that tires be replaced after six (6) years of normal service.**
- **Heat caused by hot climates or frequent high loading conditions can accelerate the aging process. Failure to follow this warning may cause sudden tire failure, which could lead to a loss of vehicle control resulting in an accident.**

### ***Compact spare tire replacement***

A compact spare tire has a shorter tread life than a regular size tire. Replace it when you can see the tread wear indicator bars on the tire. The replacement compact spare tire should be the same size and design tire as the one provided with your new vehicle and should be mounted on the same compact spare tire wheel. The compact spare tire is not designed to be mounted on a regular size wheel, and the compact spare tire wheel is not designed for mounting a regular size tire.



### **WARNING**

**The original tire should be repaired or replaced as soon as possible to avoid failure of the spare and loss of vehicle control resulting in an accident. The compact spare tire is for emergency use only. Do not operate your vehicle over 50 mph (80 km/h) when using the compact spare tire.**

### **Wheel Replacement**

When replacing the metal wheels for any reason, make sure the new wheels are equivalent to the original factory units in diameter, rim width and offset.

### **Tire Traction**

Tire traction can be reduced if you drive on worn tires, tires that are improperly inflated or on slippery road surfaces. Tires should be replaced when tread wear indicators appear. To reduce the possibility of losing control, slow down whenever there is rain, snow or ice on the road.

### **Tire Maintenance**

In addition to proper inflation, correct wheel alignment helps to decrease tire wear. If you find a tire is worn unevenly, have your dealer check the wheel alignment.

When you have new tires installed, make sure they are balanced. This will increase vehicle ride comfort and tire life. Additionally, a tire should always be rebalanced if it is removed from the wheel.

### Tire Sidewall Labeling

This information identifies and describes the fundamental characteristics of the tire and also provides the tire identification number (TIN) for safety standard certification. The TIN can be used to identify the tire in case of a recall.

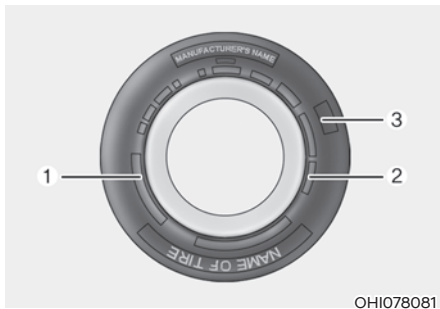

#### 1. **Manufacturer or brand name**

Manufacturer or brand name is shown.

#### 2. **Tire size designation**

A tire's sidewall is marked with a tire size designation. You will need this information when selecting replacement tires for your car. The following explains what the letters and numbers in the tire size designation mean.

Example tire size designation:

(These numbers are provided as an example only; your tire size designator could vary depending on your vehicle.)

#### **245/60R18 105H**

245 - Tire width in millimeters.

60 - Aspect ratio. The tire's section height as a percentage of its width.

R - Tire construction code (Radial).

18 - Rim diameter in inches.

105 - Load Index, a numerical code associated with the maximum load the tire can carry.

H - Speed Rating Symbol. See the speed rating chart in this section for additional information.

#### **Wheel size designation**

Wheels are also marked with important information that you need if you ever have to replace one. The following explains what the letters and numbers in the wheel size designation mean.

Example wheel size designation:

#### **7.5J X 18**

7.5 - Rim width in inches.

J - Rim contour designation.

18 - Rim diameter in inches.



### Tire speed ratings

The chart below lists many of the different speed ratings currently being used for passenger vehicle tires. The speed rating is part of the tire size designation on the sidewall of the tire. This symbol corresponds to that tire's designed maximum safe operating speed.

Speed Rating Symbol	Maximum Speed
S	112 mph (180 km/h)
T	118 mph (190 km/h)
H	130 mph (210 km/h)
V	149 mph (240 km/h)
W	168 mph (270 km/h)
Y	186 mph (300 km/h)

### 3. Checking tire life (TIN : Tire Identification Number)

Any tires that are over six years old, based on the manufacturing date, (including the spare tire) should be replaced by new ones. You can find the manufacturing date on the tire sidewall (possibly on the inside of the wheel), displaying the DOT Code. The DOT Code is a series of numbers on a tire consisting of numbers and English letters. The manufacturing date is designated by the last four digits (characters) of the DOT code.

#### DOT : XXXX XXXX OOOO

The front part of the DOT shows a plant code number, tire size and tread pattern and the last four numbers indicate week and year manufactured.

For example:

DOT XXXX XXXX 1521 represents that the tire was produced in the 15th week of 2021.

### 4. Tire ply composition and material

The number of layers or plies of rubber-coated fabric in the tire. Tire manufacturers also must indicate the materials in the tire, which include steel, nylon, polyester, and others. The letter "R" means radial ply construction; the letter "D" means diagonal or bias ply construction; and the letter "B" means belted-bias ply construction.

### 5. Maximum permissible inflation pressure

This number is the greatest amount of air pressure that should be put in the tire. Do not exceed the maximum permissible inflation pressure. Refer to the Tire and Loading Information label for recommended inflation pressure.

### 6. Maximum load rating

This number indicates the maximum load in kilograms and pounds that can be carried by the tire. When replacing the tires on the vehicle, always use a tire that has the same load rating as the factory installed tire.

### **7. Uniform tire quality grading**

Quality grades can be found where applicable on the tire sidewall between tread shoulder and maximum section width.

For example:

TREADWEAR 200

TRACTION AA

TEMPERATURE A

#### **Tread wear**

The tread wear grade is a comparative rating based on the wear rate of the tire when tested under controlled conditions on a specified government test course. For example, a tire graded 150 would wear one-and-a-half times (1½) as well on the government course as a tire graded 100.

The relative performance of tires depends upon the actual conditions of their use, however, and may depart significantly from the norm due to variations in driving habits, service practices and differences in road characteristics and climate.

These grades are molded on the sidewalls of passenger vehicle tires. The tires available as standard or optional equipment on your vehicle may vary with respect to grade.

#### **Traction - AA, A, B & C**

The traction grades, from highest to lowest, are AA, A, B and C. Those grades represent the tire's ability to stop on wet pavement as measured under controlled conditions on specified government test surfaces of asphalt and concrete. A tire marked C may have poor traction performance.



#### **WARNING**

**The traction grade assigned to this tire is based on straight ahead braking traction tests, and does not include acceleration, cornering, hydroplaning, or peak traction characteristics.**

### Temperature - A, B & C

The temperature grades are A (the highest), B and C representing the tire's resistance to the generation of heat and its ability to dissipate heat when tested under controlled conditions on a specified indoor laboratory test wheel.

Sustained high temperature can cause the material of the tire to degenerate and reduce tire life, and excessive temperature can lead to sudden tire failure. Grades B and A represent higher levels of performance on the laboratory test wheel than the minimum required by law.



### **WARNING**

**The temperature grade for this tire is established for a tire that is properly inflated and not overloaded. Excessive speed, under-inflation, over-inflation, or excessive loading, either separately or in combination, can cause heat build-up and possible sudden tire failure. This may cause loss of vehicle control resulting in an accident.**

## Tire Terminology and Definitions

### **Air pressure**

The amount of air inside the tire pressing outward on the tire. Air pressure is expressed in pounds per square inch (psi) or kilopascal (kPa).

### **Accessory weight**

This means the combined weight of optional accessories. Some examples of optional accessories are automatic transmission, power seats, and air conditioning.

### **Aspect ratio**

The relationship of a tire's height to its width.

### **Belt**

A rubber coated layer of cords that is located between the plies and the tread. Cords may be made from steel or other reinforcing materials.

### **Bead**

The tire bead contains steel wires wrapped by steel cords that hold the tire onto the rim.

***Bias ply tire***

A pneumatic tire in which the plies are laid at alternate angles less than 90 degrees to the centerline of the tread.

***Cold tire pressure***

The amount of air pressure in a tire, measured in pounds per square inch (psi) or kilopascals (kPa) before a tire has built up heat from driving.

***Curb weight***

This means the weight of a motor vehicle with standard and optional equipment including the maximum capacity of fuel, oil and coolant, but without passengers and cargo.

***DOT markings***

A code molded into the sidewall of a tire signifying that the tire is in compliance with the U.S. Department of Transportation motor vehicle safety standards. The DOT code includes the Tire Identification Number (TIN), an alphanumeric designator which can also identify the tire manufacturer, production plant, brand and date of production.

***GVWR***

Gross Vehicle Weight Rating

***GAWR FRT***

Gross Axle Weight Rating for the Front Axle.

***GAWR RR***

Gross Axle Weight Rating for the Rear axle.

***Intended outboard sidewall***

The side of an asymmetrical tire, that must always face outward when mounted on a vehicle.

***Kilopascal (kPa)***

The metric unit for air pressure.

***Light Truck (LT) tire***

A tire designated by its manufacturer as primarily intended for use on lightweight trucks or multipurpose passenger vehicles.

***Load ratings***

The maximum load that a tire is rated to carry for a given inflation pressure.

***Load index***

An assigned number ranging from 1 to 279 that corresponds to the loadcarrying capacity of a tire.

***Maximum inflation pressure***

The maximum air pressure to which a cold tire may be inflated. The maximum air pressure is molded onto the sidewall.

***Maximum load rating***

The load rating for a tire at the maximum permissible inflation pressure for that tire.

**Maximum loaded vehicle weight**

The sum of curb weight; accessory weight; vehicle capacity weight; and production options weight.

**Normal occupant weight**

The number of occupants a vehicle is designed to seat multiplied by 150 pounds (68 kg).

**Occupant distribution**

Designated seating positions.

**Outward facing sidewall**

An asymmetrical tire has a particular side that faces outward when mounted on a vehicle. The outward facing sidewall bears white lettering or bears manufacturer, brand, and/or model name molding that is higher or deeper than the same moldings on the inner facing sidewall.

**Passenger (P-Metric) tire**

A tire used on passenger cars and some light duty trucks and multipurpose vehicles.

**Ply**

A layer of rubber-coated parallel cords.

**Pneumatic tire**

A mechanical device made of rubber, chemicals, fabric and steel or other materials, that, when mounted on an automotive wheel provides the traction and contains the gas or fluid that sustains the load.

**Pneumatic options weight**

The combined weight of installed regular production options weighing over 5 lb. (2.3 kg) in excess of the standard items which they replace, not previously considered in curb weight or accessory weight, including heavy duty breaks, ride levelers, roof rack, heavy duty battery, and special trim.

**Recommended inflation pressure**

Vehicle manufacturer's recommended tire inflation pressure as shown on the tire placard.

**Radial ply tire**

A pneumatic tire in which the ply cords that extend to the beads are laid at 90 degrees to the centerline of the tread.

**Rim**

A metal support for a tire and upon which the tire beads are seated.

**Sidewall**

The portion of a tire between the tread and the bead.

**Speed rating**

An alphanumeric code assigned to a tire indicating the maximum speed at which a tire can operate.

### **Traction**

The friction between the tire and the road surface. The amount of grip provided.

### **Tread**

The portion of a tire that comes into contact with the road.

### **Treadwear indicators**

Narrow bands, sometimes called “wear bars”, that show across the tread of a tire when only 1/16 inch of tread remains.

### **UTQGS**

Uniform Tire Quality Grading Standards is a tire information system that provides consumers with ratings for a tire’s traction, temperature and treadwear. Ratings are determined by tire manufacturers using government testing procedures. The ratings are molded into the sidewall of the tire.

### **Vehicle capacity weight**

The number of designated seating positions multiplied by 150 lbs. (68 kg) plus the rated cargo and luggage load.

### **Vehicle maximum load on the tire**

Load on an individual tire due to curb and accessory weight plus maximum occupant and cargo weight.

### **Vehicle normal load on the tire**

Load on an individual tire that is determined by distributing to each axle its share of the curb weight, accessory weight, and normal occupant weight and dividing by 2.

### **Vehicle placard**

A label permanently attached to a vehicle showing the original equipment tire size and recommended inflation pressure.

### **All Season Tires**

HYUNDAI specifies all season tires on some models to provide good performance for use all year round, including snowy and icy road conditions. All season tires are identified by ALL SEASON and/or M+S (Mud and Snow) on the tire sidewall. Snow tires have better snow traction than all season tires and may be more appropriate in some areas.

### **Summer Tires**

HYUNDAI specifies summer tires on some models to provide superior performance on dry roads. Summer tire performance is substantially reduced in snow and ice. Summer tires do not have the tire traction rating M+S (Mud and Snow) on the tire side wall. If you plan to operate your vehicle in snowy or icy conditions, HYUNDAI recommends the use of snow tires or all season tires on all four wheels.

Longer wearing tires can be more susceptible to irregular tread wear. It is very important to follow the tire rotation interval in this chapter to achieve the tread life potential of these tires.

Cuts and punctures in radial-ply tires are repairable only in the tread area, because of side wall flexing. Consult your tire dealer for radial-ply tire repairs.



### **WARNING**

**Do not mix bias ply and radial ply tires under any circumstances. This may cause unusual handling characteristics that may cause loss of vehicle control resulting in an accident.**

### Low Aspect Ratio Tires (if equipped)

The aspect ratio is lower than 50 on low aspect ratio tires.

Because low aspect ratio tires are optimized for handling and braking, their sidewall is a little stiffer than a standard tire. Also low aspect ratio tires tend to be wider and consequently have a greater contact patch with the road surface. In some instances they may generate more road noise compared with standard tires.



### CAUTION

The side wall of a low aspect ratio tire is shorter than the normal one. Thus, the low-aspect wheel and tire are easily damaged. Follow the below instructions.

- When driving on a rough road or driving off a road, be careful not to damage the tires and wheels. After driving, inspect the tires and wheels.
- When passing over a pothole, speed bump, manhole, or curb stone, drive the vehicle slowly so as not to damage the tires and wheels.
- When there is an impact on a tire, inspect the tire condition. Or, you can contact an authorized HYUNDAI dealer.
- Inspect the tire condition and pressure every 8,000 miles (13,000 km) to prevent tire damage.
- It is difficult to recognize a tire damage only with your eyes. When there is a slight hint of a tire damage, check and replace the tire to prevent the damage caused by air leakage.
- When a tire is damaged while driving on a rough road, off a road, or over obstacles, such as a pothole, manhole, or curb stone, your warranty does not cover the damage.
- The tire information is specified on the tire side wall.

## FUSES

### ■ Blade type



Normal



Blown

### ■ Cartridge type



Normal



Blown

### ■ Multi type

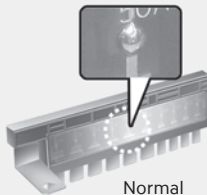

Normal

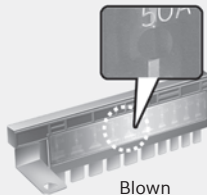

Blown

OTM078035

A vehicle's electrical system is protected from electrical overload damage by fuses.

This vehicle has 5 fuse panels, one located in the driver's side panel bolster, the other in the engine compartment.

If any of your vehicle's lights, accessories, or controls do not work, check the appropriate circuit fuse. If a fuse has blown, the element inside the fuse will be melted or broken.

If the electrical system does not work, first check the driver's side fuse panel. Before replacing a blown fuse, turn the engine and all switches off, and then disconnect the negative battery cable. Always replace a blown fuse with one of the same rating.

If the replacement fuse blows, this indicates an electrical problem. Avoid using the system involved. Immediately consult an authorized HYUNDAI dealer.



### WARNING

**NEVER** replace a fuse with anything but another fuse of the same rating.

- A higher capacity fuse could cause damage and possibly cause a fire.
- Do not install a wire or aluminum foil instead of the proper fuse - even as a temporary repair. It may cause extensive wiring damage and possibly a fire.

### NOTICE

**Do not use a screwdriver or any other metal object to remove fuses because it may cause a short circuit and damage the system.**



## Instrument Panel Fuse Replacement



1. Turn the vehicle off.
2. Turn all other switches off.
3. Open the fuse panel cover.
4. Refer to the label on the inside of the fuse panel cover to locate the suspected fuse location.

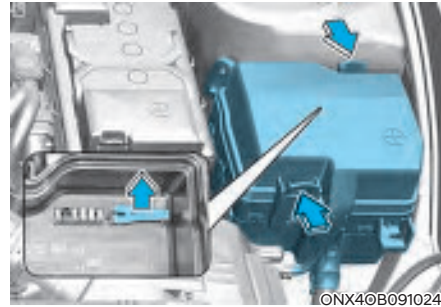

5. Pull the suspected fuse straight out. Use the removal tool (1) provided in the engine compartment fuses panel cover.
6. Check the removed fuse; replace it if it is blown. Spare fuses are provided in the instrument panel fuse panels (or in the engine compartment fuse panel).
7. Push in a new fuse of the same rating, and make sure it fits tightly in the clips. If it fits loosely, consult an authorized HYUNDAI dealer.

In an emergency, if you do not have a spare fuse, use a fuse of the same rating from a circuit you may not need for operating the vehicle, such as the cigarette lighter fuse.

If the headlamps or other electrical components do not work and the fuses are undamaged, check the fuse panel in the engine compartment. If a fuse is blown, it must be replaced with the same rating.

## Engine Compartment Panel Fuse Replacement

### Blade fuse / Cartridge fuse

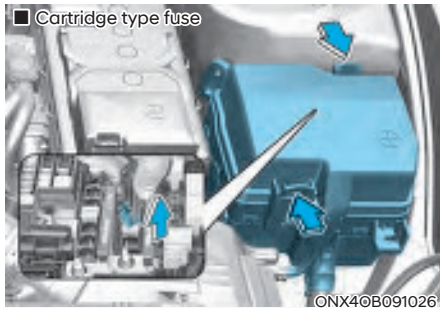
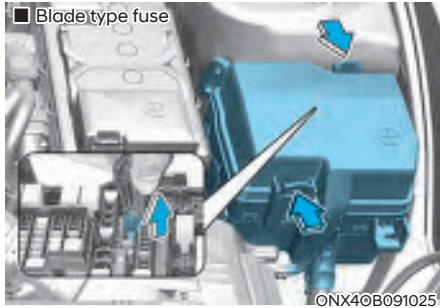

1. Turn the vehicle off.
2. Turn all other switches off.
3. Remove the fuse panel cover by pressing the tap and pulling up.
4. Check the removed fuse; replace it if it is blown. To remove or insert the fuse, use the fuse puller in the engine compartment fuse panel.
5. Push in a new fuse of the same rating, and make sure it fits tightly in the clips. If it fits loosely, consult an authorized HYUNDAI dealer.

### NOTICE

After checking the fuse panel in the engine compartment, securely install the fuse panel cover. You may hear a clicking sound if the cover is securely latched. If it is not securely latched, electrical failure may occur from water contact.

### Multi fuse

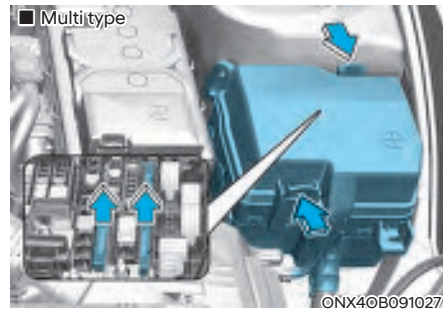

If the multi fuse or midi fuse is blown, consult an authorized HYUNDAI dealer.

**Fuse/Relay Panel Description**  
**Instrument panel fuse panel**



ONX4090019

Inside the fuse/relay box cover, you can find the fuse/relay label describing fuse/relay names and ratings.

**i Information**

Not all fuse panel descriptions in this manual may be applicable to your vehicle; the information is accurate at the time of printing. When you inspect the fuse box on your vehicle, refer to the fuse box label.

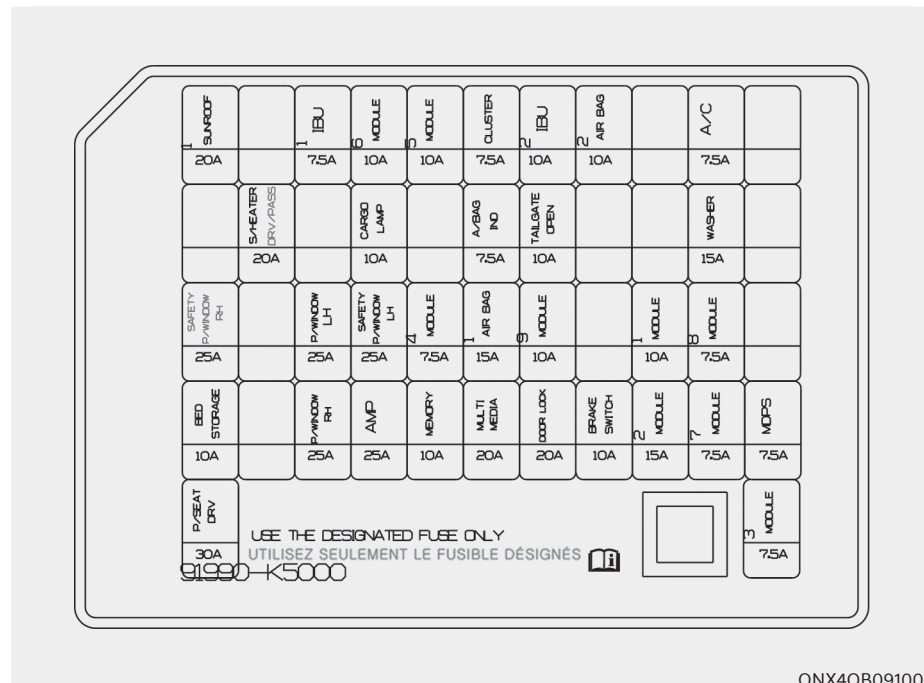

ONX40B091002

**Instrument panel fuse panel**

Fuse Name	Fuse Rating	Circuit Protected
SUNROOF1	20A	Sunroof Glass Motor Controller
IBU1	7.5A	IBU
MODULE6	10A	Console Switch, Upper Console Switch, A/T Shift Lever Indicator
MODULE5	10A	AMP, A/C Control Switch, A/C Control Module, Electro Chromic Mirror, Data Link Connector, Audio, A/V & Navigation Head Unit, Front Wireless Charger, Front Air Ventilation Seat Control Module, Front Seat Warmer Control Module
CLUSTER	7.5A	Instrument Cluster
IBU2	10A	IBU, Ignition Switch, IAU, BLE Unit
AIR BAG2	10A	SRS Control Module
A/C	7.5A	A/C Control Module, A/C Control Switch, E/R Junction Block (PTC Heater Relay)
S/HEATER DRV/PASS	20A	Front Air Ventilation Seat Control Module, Front Seat Warmer Control Module
CARGO LP	10A	High-mounted Stop Lamp, Side Mounted Bed Lamp LH/ RH
A/BAG IND	7.5A	Instrument Cluster, Overhead Console Lamp
TAILGATE OPEN	10A	Tailgate Relay
WASHER	15A	Multifunction Switch
SAFETY P/WINDOW RH	25A	Passenger Safety Power Window Module
P/WINDOW LH	25A	Power Window Main Switch
SAFETY P/WINDOW LH	25A	Driver Safety Power Window Module

Fuse Name	Fuse Rating	Circuit Protected
MODULE4	7.5A	Multifunction Front View Camera, Crash Pad Switch, WD ECM, Intergrated Parking Assist Unit
AIR BAG1	15A	SRS Control Module, Passenger Occupant Detection Sensor
MODULE9	10A	Hazard Switch, Key Solenoid, Crash Pad Switch, Data Link Connector, Rain Sensor, Driver/Passenger Smart Key Outside Handle, Sport Mode Switch, E/R Junction Block (E-CVVT Relay)
MODULE1	10A	IBU, IAU, Audio, A/V & Navigation Head Unit, Keyboard, Intergrated Parking Assist Unit
MODULE8	7.5A	Front Air Ventilation Seat Control Module, AC Inverter Module, Front Seat Warmer Control Module, AC Inverter Outlet
BED STORAGE	10A	Bed Storage Relay
P/WINDOW RH	25A	Power Window Main Switch, Passenger Power Window Switch
AMP	25A	AMP
MEMORY	10A	Instrument Cluster, Driver/Passenger Door Mood Lamp, Mood Lamp Unit, Crash Pad Mood Lamp, A/C Control Module, A/C Control Switch
MULTIMEDIA	25A	Audio, A/V & Navigation Head Unit
DOOR LOCK	20A	Center Door Lock Relay, Center Door Unlock Relay, Two Turn Unlock Relay
BRAKE SWITCH	10A	Stop Lamp Switch, IBU
MODULE2	15A	Front USB Charger, Rear USB Charger
MODULE7	7.5A	IBU, IAU
MDPS	7.5A	MDPS Unit
P/SEAT DRV	30A	Driver Power Seat Switch, Driver Power Seat Module
MODULE3	7.5A	Stop Lamp Switch, IAU, Sport Mode Switch (DCT)

**Engine compartment fuse panel  
(Engine room junction block)**

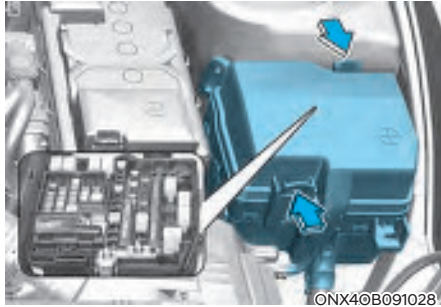

Inside the fuse/relay box cover, you can find the fuse/relay label describing fuse/relay names and ratings.

**i Information**

Not all fuse panel descriptions in this manual may be applicable to your vehicle; the information is accurate at the time of printing. When you inspect the fuse panel in your vehicle, refer to the fuse panel label.

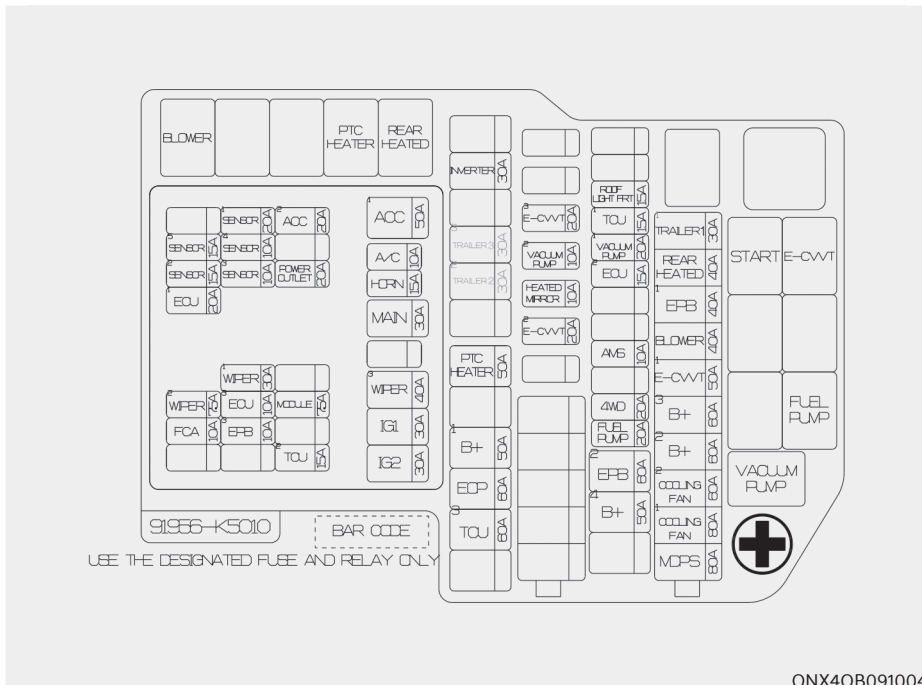

## Engine compartment fuse panel

Type	Fuse Name	Fuse Rating	Circuit Protected
MULTI FUSE	MDPS	80A	MDPS Unit
	COOLING FAN1	80A	[G4KP] Cooling Fan Controller
	COOLING FAN2	60A	[G4KN] Cooling Fan Controller
	B+2	60A	ICU Junction Block (IPS7, IPS8, IPS9, IPS10, IPS11, IPS12)
	B+3	60A	ICU Junction Block (Fuse - P/SEAT DRV, SAFETY P/ WINDOW RH, S/HEATER DRV/PASS, SUNROOF1, BED STORAGE, Power Window Main Relay)
	E-CVVT1	50A	E/R Junction Block (E-CVVT Relay)
	BLOWER	40A	E/R Junction Block (Blower Relay)
	EPB1	40A	ESC Module
	REAR HEATED	40A	E/R Junction Block (Rear Heated Relay)
TRAILER 1	30A	[G4KP] Trailer Connector	
	B+4	40A	ICU Junction Block (Fuse - DOOR LOCK, SAFETY P/ WINDOW LH, TAILGATE OPEN, AMP, IBU2, AIR BAG2, CARGO LP, BRAKE SWITCH, MODULE9, Long Term Load Latch Relay)
	EPB2	60A	ESC Module
	FUEL PUMP	20A	E/R Junction Block (Fuel Pump Relay)
	4WD	20A	AWD ECM
	TRAILER 2	30A	[G4KN] Trailer Controller
	AMS	10A	Battery Sensor
	TRAILER 3	30A	[G4KN] Trailer Connector
	ECU2	15A	PCM/ECM
	VACUUM PUMP1	20A	[G4KP] E/R Junction Block (Vacuum Pump Relay)
	TCU1	15A	[G4KN] PCM
	ROOF LIGHT FRT	15A	Accessory Light Switch
	E-CVVT2	20A	[G4KP] ECM
	HEATED MIRROR	10A	E/R Junction Block (Rear Heated Relay), Driver/ Passenger Power Outside Mirror
	VACUUM PUMP2	10A	[G4KP] ESC Module
	TCU3	60A	[G4KP] TCM
	EOP	60A	[G4KP] Electronic Oil Pump
	B+1	50A	ICU Junction Block (IPS1, IPS3, IPS4, IPS5, IPS6,)
PTC HEATER	50A	E/R Junction Block (PTC Heater Relay)	
INVERTER	30A	AC Inverter Module	

**Engine compartment fuse panel**

Fuse Name	Fuse Rating	Circuit Protected
ACC1	50A	ACC Relay
MAIN	60A	Main Relay
WIPER3	40A	Front Wiper1 On Relay
IG1	60A	IG1 Relay
IG2	60A	IG2 Relay, E/R Junction Block (Start Relay)
SENSOR1	20A	Ignition Coil #1/#2/#3/#4
ACC2	20A	ICU Junction Block (Fuse - MODULE1, MODULE2)
SENSOR5	15A	Injector #1/#2/#3/#4 (MPI)
SENSOR4	10A	E/R Junction Block (Fuel Pump Relay)
SENSOR2	15A	Oxygen Sensor (Up), Oxygen Sensor (Down)
SENSOR3	10A	A/C Comp Relay, Oil Control Valve (Exhaust), Valiable Oil Pump Solenoid, Purge Control Solenoid Valve, Cooling Fan Controller, Canister Close Valve [G4KN] Variable Intake Solenoid Valve / [G4KP] RCV Control Solenoid Valve
POWER OUTLET	20A	Front Power Outlet
A/C	10A	A/C Comp Relay
HORN	10A	Horn Relay
ECU1	20A	PCM/ECM
WIPER1	30A	Front Wiper2 (Low) Relay, Front Wiper Motor
WIPER2	7.5A	IBU
ECU3	10A	PCM/ECM
MODULE	7.5A	[G4KP] E/R Junction Block (Vacuum Pump Relay)
FCA	10A	Front Radar
EPB3	10A	ESC Module
TCU2	15A	[G4KP] TCM



## LIGHT BULBS

Consult an authorized HYUNDAI dealer to replace most vehicle light bulbs. It is difficult to replace vehicle light bulbs because other parts of the vehicle must be removed before you can get to the bulb. This is especially true for removing the headlamp assembly to get to the bulb(s).

Removing/installing the headlamp assembly can result in damage to the vehicle.



### WARNING

- Prior to replacing a lamp, depress the foot brake, move the shift button into P (Park) apply the parking brake, place the ignition switch to the LOCK/OFF position, and take the key with you when leaving the vehicle to avoid sudden movement of the vehicle and to prevent possible electric shock.
- Be aware the bulbs may be hot and may burn your fingers.

### NOTICE

Be sure to replace the burned-out bulb with one of the same wattage rating. Otherwise, it may cause damage to the fuse or electrical wiring system.

### NOTICE

To prevent damage, do not clean the headlamp lens with chemical solvents or strong detergents.



### Information - Headlamp and rear combination lamp desiccant (if equipped)

This vehicle is equipped with desiccant packs to reduce fogging inside the headlamp and rear combination lamp due to moisture. The desiccant pack is made of moisture absorbing materials and its performance may change based on the used period or environment. If fogging inside the headlamp or rear combination lamp due to moisture continues for a long time, consult an authorized HYUNDAI dealer.



### Information

The headlamp and tail lamp lenses could appear frosty if the vehicle is washed after driving or the vehicle is driven at night in wet weather. This condition is caused by temperature difference between the lamp inside and outside and, it does not indicate a problem with your vehicle. When moisture condenses in the lamp, it will be removed after driving with the headlamp on. The removable level may differ depending on lamp size, lamp position and environmental condition. However, if moisture is not removed, have the vehicle inspected by an authorized HYUNDAI dealer.

**i** Information

- A normally functioning lamp may flicker momentarily to stabilize the vehicle's electrical control system. However, if the lamp goes out after flickering momentarily, or continues to flicker, have the system checked by an authorized HYUNDAI dealer.
- The position lamp may not turn on when the position lamp switch is turned on, but the position lamp and headlamp switch may turn on when the headlamp switch is turned on. This may be caused by network failure or vehicle electrical control system malfunction. If this occurs, have the system checked by an authorized HYUNDAI dealer.

**i** Information

The headlamp aiming should be adjusted after an accident or after the headlamp assembly is reinstalled.

**Headlamp, Position Lamp, Turn Signal Lamp, Daytime Running Light (DRL) Replacement  
Type A (bulb)**

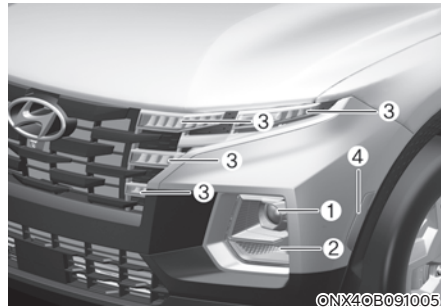

- (1) Headlamp (Low/High)
- (2) Turn signal lamp
- (3) Daytime running light/ Position light
- (4) Side marker

**Headlamp / Turn signal lamp**

1. Engage the parking brake and disconnect the negative battery cable



2. Remove wheel guard clips (under the front bumper : 4 pieces).

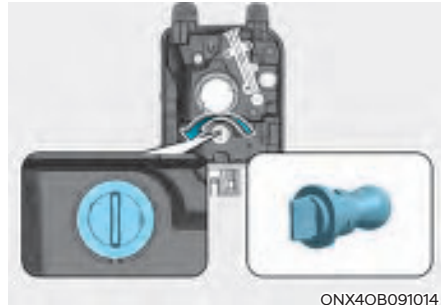

ONX4OB091014

3. Push the wheel guard aside and remove the bulb socket by turning it counterclockwise.
4. Remove the bulb from the socket by pressing it in and rotating it counterclockwise until the tabs on the bulb align with the slots in the socket. Pull the bulb out of the socket.
5. Install a new bulb by inserting it into the socket and rotating it until it locks into place.
6. Push the socket into the assembly and turn the socket clockwise.
7. Install the wheel guard in the reverse order.

#### **Daytime running light, position light, Side Marker (LED)**

If the LED lamp does not operate, have the system be inspected by an authorized HYUNDAI dealer. The LED lamps cannot be replaced as a single unit because it is an integrated unit. The LED lamps have to be replaced with the unit. A skilled technician should check or repair the LED lamp, for it may damage related parts of the vehicle.

#### **Type B (LED)**

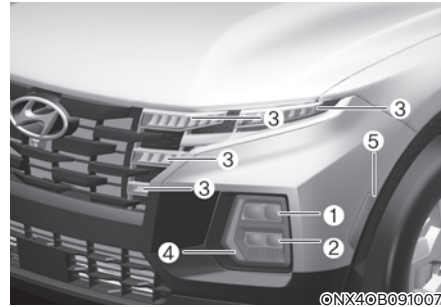

©NX4OB091007

- (1) Headlamp (Low)
- (2) Headlamp (High)
- (3) Daytime running light/Position light
- (4) Turn signal lamp
- (5) Side marker

If the LED lamp does not operate, have the system be inspected by an authorized HYUNDAI dealer. The LED lamps cannot be replaced as a single unit because it is an integrated unit. The LED lamps have to be replaced with the unit.

A skilled technician should check or repair the LED lamp, for it may damage related parts of the vehicle.

### Side Repeater Lamp Replacement



If the LED lamp (1) does not operate, have the system be inspected by an authorized HYUNDAI dealer.

The LED lamps cannot be replaced as a single unit because it is an integrated unit. The LED lamps has to be replaced with the unit.

A skilled technician should check or repair the LED lamp, for it may damage related parts of the vehicle.

### Rear Combination Lamp Replacement

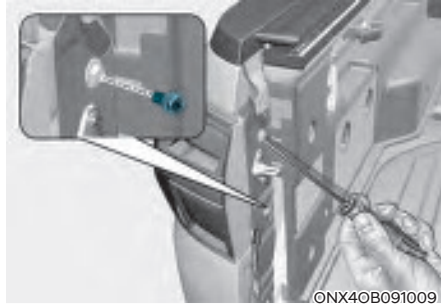

- (1) Tail lamp
- (2) Turn signal lamp/ Stop Lamp
- (3) Tail lamp
- (4) Rear side marker

**Turn signal lamp/ Stop lamp**

1. Turn off the engine.
2. Open the tailgate.
3. Remove the lamp assembly retaining bolts with cross-tip screw driver.
4. Remove the rear combination lamp assembly from the body of the vehicle.
5. Remove the socket from the assembly by turning the socket counterclockwise until the tabs on the socket align with the slots on the assembly.

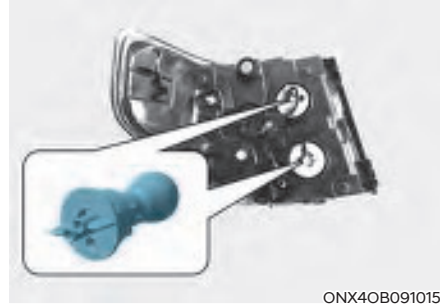

6. Remove the bulb from the socket by pressing it in and rotating it counterclockwise until the tabs on the bulb align with the slots in the socket. Pull the bulb out of the socket.
7. Insert a new bulb by inserting it into the socket and rotating it until it locks into place.
8. Install the socket into the assembly by aligning the tabs on the socket with the slots in the assembly. Push the socket into the assembly and turn the socket clockwise.
9. Reinstall the lamp assembly to the body of the vehicle.

### Tail lamp/Rear side marker

If the LED lamp does not operate, have the system be inspected by an authorized HYUNDAI dealer. The LED lamps cannot be replaced as a single unit because it is an integrated unit. The LED lamps has to be replaced with the unit.

A skilled technician should check or repair the LED lamp, for it may damage related parts of the vehicle.

### Reverse lamp

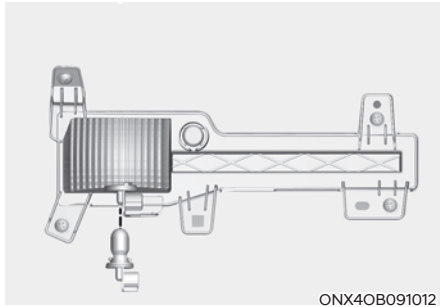

1. Turn off the engine.
2. Remove the socket from the assembly by turning the socket counterclockwise until the tabs on the socket align with the slots on the assembly.
3. Remove the bulb from the socket by pressing it in and rotating it counterclockwise until the tabs on the bulb align with the slots in the socket. Pull the bulb out of the socket.
4. Insert a new bulb by inserting it into the socket and rotating it until it locks into place.

### High Mounted Stop Lamp and Top Mounted Bed Lamp / Side Mounted Bed Lamp Replacement



[A] : High Mounted Stop Lamp  
[B] : Top Mounted Bed Lamp

If the LED light source does not operate, have the system be inspected by an authorized HYUNDAI dealer.

The LED light source cannot be replaced as a single unit because it is an integrated part of the lamp. The LED lamp has to be replaced as a unit.

A skilled technician should check or repair the LED lamp, because it may damage related parts of the vehicle.

## License Plate Lamp Replacement

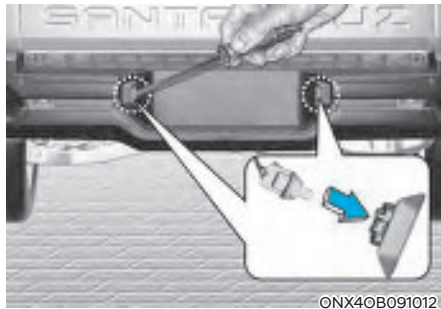

©NX40B091012

1. Using flat-blade screwdriver, gently pry on the inside edge of the lamp housing, compressing the metal clip on the opposite side. Once clip is compressed, lamp will rotate out of location in bumper.
2. Remove Bulb by rotating bulb in the direction indicated on holder.
3. Remove bulb from holder by pulling it straight out.
4. Install a new bulb.
5. Reinstall the lamp by compressing the clip in the bumper and rotating the lamp to hook the housing back into place on the bumper.

## Interior light replacement

### Map/Rear lamp (LED)



©NX40B091013



©NX40B091031

If the LED lamp does not operate, have the system be inspected by an authorized HYUNDAI dealer.

The LED lamps cannot be replaced as a single unit because it is an integrated unit. The LED lamps has to be replaced with the unit.

A skilled technician should check or repair the LED lamp, for it may damage related parts of the vehicle.

**Map lamp, Room lamp and Sunvisor lamp (Bulb type)**

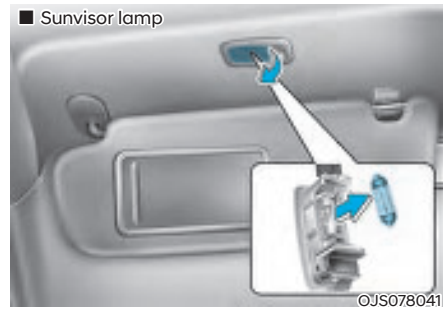

1. Using a flat-head screwdriver, gently pry the lens from the interior light housing.
2. Remove the bulb by pulling it straight out.
3. Install a new bulb into the socket.
4. Align the lens tabs with the interior light housing notches and snap the lens into place.

**NOTICE**

**Be careful not to damage the cover, tab, and plastic housing.**



## APPEARANCE CARE

### Exterior Care

#### **Exterior general caution**

It is very important to follow the label directions when using any chemical cleaner or polish. Read all warning and caution statements that appear on the label.

#### **Finish maintenance**

##### **Washing**

To help protect your vehicle's finish from rust and deterioration, wash it thoroughly and frequently at least once a month with lukewarm or cold water.

If you use your vehicle for off-road driving, you should wash it after each off-road trip. Pay special attention to the removal of any accumulation of salt, dirt, mud, and other foreign materials. Make sure the drain holes in the lower edges of the doors and rocker panels are kept clear and clean.

Insects, tar, tree sap, bird droppings, industrial pollution and similar deposits can damage your vehicle's finish if not removed immediately.

Even prompt washing with plain water may not completely remove all these deposits. A mild soap, safe for use on painted surfaces, should be used.

After washing, rinse the vehicle thoroughly with lukewarm or cold water. Do not allow soap to dry on the finish.

#### **High-pressure washing**

- When using high-pressure washers, make sure to maintain sufficient distance from the vehicle. Insufficient clearance or excessive pressure can lead to component damage or water penetration.
- Do not spray the camera, sensors or its surrounding area directly with a high pressure washer. Shock applied from high pressure water may cause the device to not operate normally.
- Do not bring the nozzle tip close to boots (rubber or plastic covers) or connectors as they may be damaged if they come into contact with high pressure water.



#### **WARNING**

**After washing the vehicle, test the brakes while driving slowly to see if they have been affected by water before getting on the road. If braking performance is impaired, dry the brakes by applying them lightly while maintaining a slow forward speed.**

#### **NOTICE**

- **Do not use strong soap, chemical detergents or hot water, and do not wash the vehicle in direct sunlight or when the body of the vehicle is warm.**
- **Be careful when washing the side windows of your vehicle.**
- **Especially, with high-pressure water, water may leak through the windows and wet the interior.**
- **To prevent damage to the plastic parts, do not clean with chemical solvents or strong detergents.**

**NOTICE**



- **Water washing in the engine compartment including high pressure water washing may cause the failure of electrical circuits located in the engine compartment.**
- **Never allow water or other liquids to come in contact with electrical/ electronic components inside the vehicle as this may damage them.**

**NOTICE**

**Matte paint finish vehicle (if equipped)**  
Automatic car wash which uses rotating brushes should not be used as this can damage the surface of your vehicle. A steam cleaner which washes the vehicle surface at high temperature may result the oil to adhere and leave stains that is difficult to remove.

Use a soft cloth (for example, microfiber towel or sponge) when washing your vehicle and dry with a microfiber towel. When you hand wash your vehicle, you should not use a cleaner that finishes with wax. If the vehicle surface is too dirty (sand, dirt, dust, contaminant, etc.), clean the surface with water before washing the car.

**Waxing**

A good coat of wax is a barrier between your paint and contaminate. Keeping a good coat of wax on your vehicle will help protect it.

Wax the vehicle when water will no longer bead on the paint.

Always wash and dry the vehicle before waxing. Use a good quality liquid or paste wax, and follow the manufacturer's instructions. Wax all metal trim to protect it and to maintain its luster.

Removing oil, tar, and similar materials with a spot remover will usually strip the wax from the finish. Be sure to re-wax these areas even if the rest of the vehicle does not yet need waxing.

**NOTICE**

- **Wiping dust or dirt off the body with a dry cloth will scratch the finish.**
- **Do not use steel wool, abrasive cleaners, or strong detergents containing highly alkaline or caustic agents on chrome-plated or anodized aluminum parts. This may result in damage to the protective coating and cause discoloration or paint deterioration.**

**NOTICE**

**Matte paint finish vehicle (if equipped)**  
Do not use any polish protector such as a detergent, an abrasive and a polish. In case wax is applied, remove the wax immediately using a silicon remover and if any tar or tar contaminant is on the surface use a tar remover to clean. However, be careful not to apply too much pressure on the painted area.

**Finish damage repair**

Deep scratches or stone chips in the painted surface must be repaired promptly. Exposed metal will quickly rust and may develop into a major repair expense.

**NOTICE**

**If your vehicle is damaged and requires any metal repair or replacement, be sure the body shop applies anti-corrosion materials to the parts repaired or replaced.**

**NOTICE**

**Matte paint finish vehicle (if equipped)**  
**In case of matte paint finish vehicles, it is impossible to modify only the damaged area and repair of the whole part is necessary. If the vehicle is damaged and painting is required, have your vehicle maintained and repaired by an authorized HYUNDAI dealer. Take extreme care, as it is difficult to restore the quality after the repair.**

**Bright-metal maintenance**

- To remove road tar and insects, use a tar remover, not a scraper or other sharp object.
- To protect the surfaces of bright metal parts from corrosion, apply a coating of wax or chrome preservative and rub to a high luster.
- During winter weather or in coastal areas, cover the bright metal parts with a heavier coating of wax or preservative. If necessary, coat the parts with non-corrosive petroleum jelly or other protective compound.

**Underbody maintenance**

Corrosive materials used for ice and snow removal and dust control may collect on the underbody. If these materials are not removed, accelerated rusting can occur on underbody parts such as the fuel lines, frame, floor pan and exhaust system, even though they have been treated with rust protection.

Thoroughly flush the vehicle underbody and wheel openings with lukewarm or cold water once a month, after off-road driving and at the end of each winter. Pay special attention to these areas because it is difficult to see all the mud and dirt. It will do more harm than good to wet down the road grime without removing it. The lower edges of doors, rocker panels, and frame members have drain holes that should not be allowed to clog with dirt; trapped water in these areas can cause rusting.

**WARNING**

**After washing the vehicle, test the brakes while driving slowly to see if they have been affected by water. If braking performance is impaired, dry the brakes by applying them lightly while maintaining a slow forward speed.**

### **Aluminum wheel maintenance**

The aluminum wheels are coated with a clear protective finish.

- Do not use abrasive cleaner, polishing compound, solvent, or wire brushes on aluminum wheels.
- Clean the wheel when it has cooled.
- Use only a mild soap or neutral detergent, and rinse thoroughly with water. Also, clean the wheels after driving on salted roads.
- Do not wash the wheels with high-speed car wash brushes.
- Do not use any cleaners containing acid or alkaline detergents.

### **Corrosion protection**

#### **Protecting your vehicle from corrosion**

By using the most advanced design and construction practices to combat corrosion, HYUNDAI produces vehicles of the highest quality. However, this is only part of the job. To achieve the long-term corrosion resistance your vehicle can deliver, the owner's cooperation and assistance is also required.

#### **Common causes of corrosion**

The most common causes of corrosion on your vehicle are:

- Road salt, dirt and moisture that is allowed to accumulate underneath the vehicle.
- Removal of paint or protective coatings by stones, gravel, abrasion or minor scrapes and dents which leave unprotected metal exposed to corrosion.

### **High-corrosion areas**

If you live in an area where your vehicle is regularly exposed to corrosive materials, corrosion protection is particularly important. Some of the common causes of accelerated corrosion are road salts, dust control chemicals, ocean air and industrial pollution.

### **Moisture breeds corrosion**

Moisture creates the conditions in which corrosion is most likely to occur. For example, corrosion is accelerated by high humidity, particularly when temperatures are just above freezing. In such conditions, the corrosive material is kept in contact with the vehicle surfaces by moisture that is slow to evaporate.

Mud is particularly corrosive because it is slow to dry and holds moisture in contact with the vehicle. Although the mud appears to be dry, it can still retain moisture and promote corrosion.

High temperatures can also accelerate corrosion of parts that are not properly ventilated so the moisture can be dispersed. For all these reasons, it is particularly important to keep your vehicle clean and free of mud or accumulations of other materials. This applies not only to the visible surfaces but particularly to the underside of the vehicle.

**To help prevent corrosion****Keep your vehicle clean**

The best way to prevent corrosion is to keep your vehicle clean and free of corrosive materials. Attention to the underside of the vehicle is particularly important.

- If you live in a high-corrosion area — where road salts are used, near the ocean, areas with industrial pollution, acid rain, etc.—, you should take extra care to prevent corrosion. In winter, hose off the underside of your vehicle at least once a month and be sure to clean the underside thoroughly when winter is over.
- When cleaning underneath the vehicle, pay particular attention to the components under the fenders and other areas that are hidden from view. Do a thorough job; just dampening the accumulated mud rather than washing it away will accelerate corrosion rather than prevent it. Water under high pressure and steam are particularly effective in removing accumulated mud and corrosive materials.
- When cleaning lower door panels, rocker panels and frame members, be sure that drain holes are kept open so that moisture can escape and not be trapped inside to accelerate corrosion.

**Keep your garage dry**

Don't park your vehicle in a damp, poorly ventilated garage. This creates a favorable environment for corrosion. This is particularly true if you wash your vehicle in the garage or drive it into the garage when it is still wet or covered with snow, ice or mud. Even a heated garage can contribute to corrosion unless it is well ventilated so moisture is dispersed.

**Keep paint and trim in good condition**

Scratches or chips in the finish should be covered with "touch-up" paint as soon as possible to reduce the possibility of corrosion. If bare metal is showing through, the attention of a qualified body and paint shop is recommended.

Bird droppings are highly corrosive and may damage painted surfaces in just a few hours. Always remove bird droppings as soon as possible.

## Interior Care

### **Interior general precautions**

Prevent caustic solutions such as perfume and cosmetic oil, from contacting the interior parts because they may cause damage or discoloration. If they do contact the interior parts, wipe them off immediately. See the instructions for the proper way to clean vinyl.

#### **NOTICE**

- **Never allow water or other liquids to come in contact with electrical/electronic components inside the vehicle as this may damage them.**
- **When cleaning leather products (steering wheel, seats etc.), use neutral detergents or low alcohol content solutions. If you use high alcohol content solutions or acid/alkaline detergents, the color of the leather may fade or the surface may get stripped off.**

### **Cleaning the upholstery and interior trim**

#### **Vinyl (if equipped)**

Remove dust and loose dirt from vinyl with a whisk broom or vacuum cleaner. Clean vinyl surfaces with a vinyl cleaner.

#### **Fabric (if equipped)**

Remove dust and loose dirt from fabric with a whisk broom or vacuum cleaner. Clean with a mild soap solution recommended for upholstery or carpets. Remove fresh spots immediately with a fabric spot cleaner. If fresh spots do not receive immediate attention, the fabric can be stained and its color can be affected. Also, its fire-resistant properties can be reduced if the material is not properly maintained.

#### **NOTICE**

**Using anything but recommended cleaners and procedures may affect the fabric's appearance and fire-resistant properties.**

**Leather (if equipped)**

- Features of seat leather

- Leather is made from the outer skin of an animal, which goes through a special process to be available for use. Since it is a natural product, each part differs in thickness or density.

Wrinkles may appear as a natural result of stretching and shrinking depending on the temperature and humidity.

- The seat is made of stretchable fabric to improve comfort.
- The parts contacting the body are curved and the side supporting area is high which provides driving comfort and stability.
- Wrinkles may appear naturally from usage. It is not a fault of the products.

**NOTICE**

- **Wrinkles or abrasions which appear naturally from usage are not covered by warranty.**
- **Belts with metallic accessories, zippers or keys inside the back pocket may damage the seat fabric.**
- **Make sure not to wet the seat. It may change the nature of natural leather.**
- **Jeans or clothes which could bleach may contaminate the surface of the seat covering fabric.**

- Caring for the leather seats

- Vacuum the seat periodically to remove dust and sand on the seat. It will prevent abrasion or damage of the leather and maintain its quality.
- Wipe the natural leather seat cover often with dry or soft cloth.
- Use of proper leather protector may prevent abrasion of the cover and helps maintain the color. Be sure to read the instructions and consult a specialist when using leather coating or protective agent.
- Light colored (beige, cream beige) leather is easily contaminated and the stain is noticeable. Clean the seats frequently.
- Avoid wiping with wet cloth. It may cause the surface to crack.

- Cleaning the leather seats

- Remove all contaminations instantly. Refer to instructions below for removal of each contaminant.
- Cosmetic products (sunscreen, foundation, etc.)  
Apply cleansing cream on a cloth and wipe the contaminated spot. Wipe off the cream with a wet cloth and remove water with a dry cloth.
- Beverages (coffee, soft drink, etc.)  
Apply a small amount of neutral detergent and wipe until contaminations do not smear.

- Oil  
Remove oil instantly with absorbable cloth and wipe with stain remover used only for natural leather.
- Chewing gum  
Harden the gum with ice and remove gradually.
- Handling prime napa leather (if equipped)  
Try to avoid excessive sunlight and heat exposure. Excessive sunlight and heat exposure naturally fades and dries out napa leather, causing wrinkles and discoloration. If the napa leather is wet with liquid, immediately clean it with lint-free cloth to minimize damage. Do not scratch the napa leather surface with a sharp object. If your napa leather seat is bright colored, it may be contaminated or stained from dyed materials such as jeans.

### ***Interior wooden trim***

- Use a wooden furniture protector (for example, wax, coating compound) to clean the interior wooden trim.
- Often wipe the interior wooden trim with a lint-free, clean cloth to maintain the unique wooden textures for a longer period of time.
- If you spill beverage (for example, water, coffee) over the interior wooden trim, immediately wipe it with clean, dry cloth.

- Sharp objects (for example, driver, knife), adhesive materials, or tapes may damage the interior wooden trim.
- Any strong impacts may damage the interior wooden trim.
- If the coating finish over the interior wooden trim is removed, moisture may damage or change wood traits.
- If the interior wooden trim is damaged, you may get a splinter from the wood surface. Therefore, you should immediately have the damaged interior wooden trim replaced by an authorized HYUNDAI dealer.

### ***Cleaning the seat belt webbing***

Clean the belt webbing with any mild soap solution recommended for cleaning upholstery or carpet. Follow the instructions provided with the soap. Do not bleach or re-dye the webbing because this may weaken the seat belt.

### ***Cleaning the interior window glass***

If the interior glass surfaces of the vehicle become fogged (that is, covered with an oily, greasy or waxy film), they should be cleaned with glass cleaner. Follow the directions on the glass cleaner container.

### **NOTICE**

**Do not scrape or scratch the inside of the rear window. This may result in damage to the rear window defroster grid.**



## EMISSION CONTROL SYSTEM

The emission control system of your vehicle is covered by a written limited warranty. Please see the warranty information contained in the Service Passport in your vehicle.

Your vehicle is equipped with an emission control system to meet all applicable emission regulations. There are three emission control systems, as follows.

- (1) Crankcase emission control system
- (2) Evaporative emission control system
- (3) Exhaust emission control system

In order to ensure the proper function of the emission control systems, it is recommended that you have your vehicle inspected and maintained by an authorized HYUNDAI dealer in accordance with the maintenance schedule in this manual.

### NOTICE

#### For the Inspection and Maintenance Test (with Electronic Stability Control (ESC) system)

- **To prevent the vehicle from misfiring during dynamometer testing, turn the Electronic Stability Control (ESC) system off by pressing the ESC switch (ESC OFF light illuminated).**
- **After dynamometer testing is completed, turn the ESC system back on by pressing the ESC switch again.**

### 1. Crankcase Emission Control System

The positive crankcase ventilation system is employed to prevent air pollution caused by blow-by gases being emitted from the crankcase. This system supplies fresh filtered air to the crankcase through the air intake hose. Inside the crankcase, the fresh air mixes with blow-by gases, which then pass through the PCV valve into the induction system.

### 2. Evaporative Emission Control System

The Evaporative Emission Control System is designed to prevent fuel vapors from escaping into the atmosphere.

#### Canister

Fuel vapors generated inside the fuel tank are absorbed and stored in the onboard canister. When the engine is running, the fuel vapors absorbed in the canister are drawn into the surge tank through the purge control solenoid valve.

#### Purge Control Solenoid Valve (PCSV)

The purge control solenoid valve is controlled by the Engine Control Module (ECM); when the engine coolant temperature is low during idling, the PCSV closes so that evaporated fuel is not taken into the engine. After the engine warms-up during ordinary driving, the PCSV opens to introduce evaporated fuel to the engine.

### 3. Exhaust Emission Control System

The Exhaust Emission Control System is a highly effective system which controls exhaust emissions while maintaining good vehicle performance.

When the engine starts or fails to start, excessive attempts to restart the engine may cause damage to the emission system.

#### ***Engine exhaust (carbon monoxide) precautions***

- Carbon monoxide can be present with other exhaust fumes. If you smell exhaust fumes of any kind in your vehicle, drive with all the windows fully open. Have your vehicle checked and repaired immediately.



#### **WARNING**

Engine exhaust gases contain carbon monoxide (CO). Though colorless and odorless, it is dangerous and could be lethal if inhaled. Follow the instructions on this page to avoid CO poisoning.



#### **WARNING**

#### **CALIFORNIA PROPOSITION 65 WARNING**

Engine exhaust and a wide variety of automobile components and parts, including components found in the interior furnishings in a vehicle, contain or emit chemicals known to the State of California to cause cancer and birth defects and reproductive harm. In addition, certain fluids contained in vehicles and certain products of component wear contain or emit chemicals known to the State of California to cause cancer and birth defects or other reproductive harm.

- Do not operate the engine in confined or closed areas (such as garages) any more than what is necessary to move the vehicle in or out of the area.
- When the vehicle is stopped in an open area for more than a short time with the engine running, adjust the ventilation system (as needed) to draw outside air into the vehicle.
- Never sit in a parked or stopped vehicle for any extended time with the engine running.
- When the engine stalls or fails to start, excessive attempts to restart the engine may cause damage to the emission control system.

#### ***Operating precautions for catalytic converters (if equipped)***



#### **WARNING**

The exhaust system and catalytic converter are very hot during and immediately after the engine has been running. To avoid **SERIOUS INJURY** or **DEATH**:

- Do not park, idle, or drive the vehicle over or near flammable objects, such as grass, vegetation, paper, leaves, etc. A hot exhaust system can ignite flammable items under your vehicle.
- Keep away from the exhaust system and catalytic converter or you may get burned.

Also, do not remove the heat sink around the exhaust system, do not seal the bottom of the vehicle, and do not coat the vehicle for corrosion control. It may present a fire risk under certain conditions.

Your vehicle is equipped with a catalytic converter emission control device. To prevent damage to the catalytic converter and to your vehicle, take the following precautions:

- Use only UNLEADED FUEL for gasoline engines.
- Do not operate the vehicle when there are signs of engine malfunction, such as misfire or a noticeable loss of performance.
- Do not misuse or abuse the engine. Examples of misuse are coasting with the engine off and descending steep grades in gear with the engine off.
- Do not operate the engine at high idle speed for extended periods (5 minutes or more).
- Do not modify or tamper with any part of the engine or emission control system. All inspections and adjustments must be made by an authorized HYUNDAI dealer.
- Avoid driving with an extremely low fuel level.

Running out of fuel could cause the engine to misfire, damaging the catalytic converter.

## **CALIFORNIA PERCHLORATE NOTICE**

Perchlorate Material-special handling may apply, See:  
<https://dtsc.ca.gov/perchlorate>.

Notice to California Vehicle Dismantlers: Perchlorate containing materials, such as air bag inflators, seatbelt pretensioners and keyless remote entry batteries, must be disposed of according to Title 22 California Code of Regulations Section 67384.10 (a).

# Index

---

**A**

Accessing Your Vehicle .....	5-4
Immobilizer System .....	5-14
Remote Key.....	5-4
Smart Key.....	5-7
Air Bag - Supplemental Restraint system.....	3-42
Additional Safety Precautions.....	3-63
Air Bag Warning Labels.....	3-63
How does the SRS Air Bag System Operate?.....	3-47
Occupant Classification System (OCS) .....	3-51
SRS Care .....	3-62
What To Expect After an Air Bag Inflates .....	3-50
Where are the Air Bags?.....	3-44
Why Didn't My Air Bag Go Off in a Collision? .....	3-57
Air Cleaner.....	9-25
Filter Replacement .....	9-25
Air Conditioning System.....	2-11
All Wheel Drive (AWD) .....	6-51
AWD Operation.....	6-52
Emergency Precautions .....	6-55
Appearance Care.....	9-65
Exterior Care .....	9-65
Interior Care .....	9-70
Automatic Climate Control System.....	5-93
Automatic Heating and Air Conditioning .....	5-94
Manual Heating and Air Conditioning .....	5-95
Multi Air Mode.....	5-101
System Maintenance .....	5-104
System Operation .....	5-102
Automatic Transmission .....	6-14
Automatic Transmission Operation.....	6-14
Good Driving Practices .....	6-20
Using the Paddle Shifters .....	6-19

**B**

Battery .....	9-31
Battery Capacity Label.....	9-32
Battery Recharging.....	9-33
For Best Battery Service .....	9-32
Reset Items .....	9-34
Before Driving.....	6-4
Before Entering the Vehicle .....	6-4
Before Starting .....	6-4
Blind-Spot Collision-Avoidance Assist (BCA) .....	7-36
Blind-Spot Collision-Avoidance Assist Malfunction and Limitations.....	7-45
Blind-Spot Collision-Avoidance Assist Operation .....	7-40
Blind-Spot Collision-Avoidance Assist Settings.....	7-38
Blind-Spot View Monitor (BVM) .....	7-70
Blind-Spot View Monitor Malfunction .....	7-71
Blind-Spot View Monitor Operation.....	7-70
Blind-Spot View Monitor Settings .....	7-70
Brake Fluid .....	9-23
Checking the Brake Fluid Level.....	9-23
Braking System.....	6-29
Anti-lock Brake System (ABS).....	6-38
Auto Hold.....	6-34
Disc Brakes Wear Indicator.....	6-29
Downhill Brake Control (DBC) .....	6-44
Electronic Parking Brake (EPB) .....	6-30
Electronic Stability Control (ESC).....	6-39
Good Braking Practices.....	6-47
Hill-Start Assist Control (HAC) .....	6-44
Power-assist Brakes.....	6-29
Trailer Stability Assist (TSA) .....	6-43
Vehicle Stability Management (VSM) .....	6-42
Bulb Wattage.....	2-9

**C**

Cabin Air Filter .....	9-27
Filter Inspection.....	9-27
Filter Replacement .....	9-27
California Perchlorate Notice .....	9-76
Child Restraint System (CRS).....	3-31
Children Always in the Rear .....	3-31
Installing a Child Restraint System (CRS).....	3-34
Selecting a Child Restraint System (CRS).....	3-32
Climate Control Additional Features .....	5-109
Auto Defogging System on Models with Automatic Temperature Control... 5-109	
Auto Dehumidify.....	5-110
Automatic Controls for the Driver Based on Climate Control System	
Settings .....	5-111
Recirculating Air when washer fluid is used.....	5-111
Sunroof Inside Air Recirculation.....	5-111
Consumer Information.....	2-16
Cruise Control (CC) .....	7-72
Cruise Control Operation .....	7-72

**D**

Declaration of conformity .....	7-131
Front Radar.....	7-131
Rear Corner Radar .....	7-131
Dimensions .....	2-8
Door Locks .....	5-32
Auto Door Lock/Unlock Features .....	5-36
Child-protector Rear Door Locks.....	5-36
Operating Door Locks From Outside the Vehicle .....	5-32
Operating Door Unlocks from Inside the Vehicle .....	5-34
Drive Mode Integrated Control System .....	6-48
Driver Attention Warning (DAW) .....	7-64
Driver Attention Warning Malfunction and Limitations .....	7-67
Driver Attention Warning Operation .....	7-65
Driver Attention Warning Settings .....	7-64
Dual Clutch Transmission .....	6-21
Dual Clutch Transmission Operation .....	6-21
Good Driving Practices .....	6-28
Parking .....	6-27





## E

Emission Control System .....	9-73
Engine .....	2-8
Engine Compartment .....	2-7/ 9-3
Engine Coolant .....	9-20
Changing Coolant.....	9-22
Checking the Coolant Level.....	9-20
Engine Number.....	2-15
Engine Oil.....	9-17
Explanation of Scheduled Maintenance Items .....	9-14
Fuel Filter .....	9-14
Parking Brake.....	9-16
Exterior Features.....	5-64/ 5-131
Fuel Filler Door.....	5-68
Hood.....	5-64
Rear Bumper Steps.....	5-68
Roof Rack .....	5-131
Tailgate.....	5-65
Exterior Overview (I) .....	2-2
Exterior Overview (II).....	2-3

## F

Forward Collision-Avoidance Assist (FCA) (Front view camera only) .....	7-2
Forward Collision-Avoidance Assist Malfunction and Limitations.....	7-7
Forward Collision-Avoidance Assist Operation.....	7-5
Forward Collision-Avoidance Assist Settings.....	7-3
Forward Collision-Avoidance Assist (FCA) (Sensor fusion) .....	7-14
Forward Collision-Avoidance Assist Malfunction and Limitations.....	7-22
Forward Collision-Avoidance Assist Operation.....	7-18
Forward Collision-Avoidance Assist Settings.....	7-16
Fuses .....	9-48
Engine Compartment Panel Fuse Replacement .....	9-50
Fuse/Relay Panel Description .....	9-51
Instrument Panel Fuse Replacement .....	9-49

## G

Gross Vehicle Weight.....	2-11
---------------------------	------

**H**

Hazard Warning Flasher .....	8-2
High Beam Assist (HBA) .....	5-75
High Beam Assist Malfunction and Limitations .....	5-77
High Beam Assist Operation .....	5-76
High Beam Assist Settings .....	5-75
Highway Driving Assist (HDA) .....	7-104
Highway Driving Assist Malfunction and Limitations .....	7-108
Highway Driving Assist Operation .....	7-106
Highway Driving Assist Settings .....	7-105
Hyundai Digital Key .....	5-15

**I**

If the Engine Overheats .....	8-7
If the Engine will not Start.....	8-3
If you have a Flat Tire.....	8-14
Changing Tires .....	8-16
Jack and Tools .....	8-14
Jack Label.....	8-22
Removing and Storing the Spare Tire .....	8-15
Storing the Flat Tire.....	8-21
Ignition Switch .....	6-5
Engine Start/Stop Button.....	6-8
Key Ignition Switch .....	6-5
Remote Start.....	6-12
Vehicle Auto-Shut Off.....	6-12
Important Safety Precautions.....	3-2
Air Bag Hazards .....	3-2
Always Wear Your Seat Belt .....	3-2
Control Your Speed .....	3-2
Driver Distraction.....	3-2
Keep Your Vehicle in Safe Condition.....	3-2
Restrain All Children.....	3-2
In Case of an Emergency While Driving.....	8-2
If the Engine Stalls at a Crossroad or Crossing.....	8-2
If the Engine Stalls while Driving.....	8-2
If you have a Flat Tire while Driving.....	8-3



Infotainment System.....	5-132
Antenna .....	5-132
Bluetooth® Wireless Technology .....	5-134
How Vehicle Radio Works .....	5-135
Infotainment System .....	5-134
Steering Wheel Remote Controls.....	5-133
USB Port .....	5-132
Voice Recognition .....	5-134
Infotainment System Vehicle Settings.....	4-42
Setting Your Vehicle .....	4-42
Instrument cluster .....	4-4
Gauges and Meters.....	4-5
Instrument Cluster Control.....	4-5
LCD Display Messages for Vehicles Equipped with Smart Key .....	4-22
Transmission Shift Indicator .....	4-9
Warning and Indicator Lights.....	4-9
Instrument Panel Overview (I).....	2-5
Instrument Panel Overview (II).....	2-6
Intelligent speed limit assist (ISLA) .....	7-59
Intelligent Speed Limit Assist Malfunction and Limitations .....	7-62
Intelligent Speed Limit Assist Operation .....	7-60
Intelligent Speed Limit Assist Settings .....	7-59
Interior Features.....	5-124
Clock .....	5-129
Coat Hook .....	5-130
Cup Holder .....	5-124
Floor Mat Anchor(s).....	5-130
Power Outlet.....	5-125
Sunvisor.....	5-125
USB Charger .....	5-126
Wireless Smart Phone Charging System.....	5-127
Interior Lights .....	5-78
Front Lamps .....	5-78
Glove Box Lamp .....	5-80
Interior Lamp AUTO OFF .....	5-78
Rear Lamps .....	5-79
Vanity Mirror Lamp .....	5-79
Welcome System .....	5-80
Interior Overview .....	2-4

**J**

Jump Starting ..... 8-4

**L**

Lane Following Assist (LFA) ..... 7-100  
     Lane Following Assist Malfunction and Limitations ..... 7-103  
     Lane Following Assist Operation ..... 7-101  
     Lane Following Assist Settings ..... 7-100  
 Lane Keeping Assist (LKA) ..... 7-30  
     Lane Keeping Assist Malfunction and Limitations ..... 7-34  
     Lane Keeping Assist Operation ..... 7-32  
     Lane Keeping Assist Settings ..... 7-30  
 LCD display ..... 4-27  
     LCD Display Control ..... 4-27  
     Trip Computer (Type A : 4.2" LCD) ..... 4-38  
     Trip Computer (Type B : 10.25" LCD) ..... 4-40  
     User Settings Mode ..... 4-31  
     View Modes ..... 4-28  
 Light Bulbs ..... 9-57  
     Headlamp, Position Lamp, Turn Signal Lamp,  
         Daytime Running Light (DRL) Replacement ..... 9-58  
     High Mounted Stop Lamp and Top Mounted Bed Lamp /  
         Side Mounted Bed Lamp Replacement ..... 9-62  
     Interior light replacement ..... 9-63  
     License Plate Lamp Replacement ..... 9-63  
     Rear Combination Lamp Replacement ..... 9-60  
     Side Repeater Lamp Replacement ..... 9-60  
 Lighting ..... 5-71  
     Exterior Lights ..... 5-71  
 Luggage Compartment Features ..... 5-114  
     Rail and cleat system ..... 5-123  
     Sidewall Molded in Features ..... 5-117  
     Sidewall Side Storage ..... 5-121  
     Tie Down ..... 5-122  
     Tonneau Cover ..... 5-114  
     Underbed Storage ..... 5-119

**M**

Maintenance Services .....	9-4
Owner Maintenance Precautions.....	9-4
Owner's Responsibility .....	9-4
Manual Climate Control System .....	5-85
Heating and Air Conditioning .....	5-86
System Maintenance .....	5-91
System Operation .....	5-90
Manual Speed Limit Assist (MSLA) .....	7-56
Manual Speed Limit Assist Operation .....	7-56
Mirrors .....	5-42
Inside Rearview Mirror .....	5-42
Side View Mirrors .....	5-52

**N**

Navigation-Based Smart Cruise Control (NSCC) .....	7-93
Limitations of Navigation-based Smart Cruise Control .....	7-96
Navigation-based Smart Cruise Control Operation .....	7-94
Navigation-based Smart Cruise Control Settings.....	7-94

**O**

Owner Maintenance.....	9-5
Owner Maintenance Schedule.....	9-6

**R**

Rear Cross-Traffic Collision-Avoidance Assist (RCCA) .....	7-120
Rear Cross-Traffic Collision- Avoidance Assist Malfunction and Limitations .....	7-126
Rear Cross-Traffic Collision- Avoidance Assist Operation.....	7-122
Rear Cross-Traffic Collision-Avoidance Assist Settings.....	7-121
Rear Occupant Alert (ROA) .....	5-38
Rear Occupant Alert Operation .....	5-38
Rear View Monitor (RVM) .....	7-111
Rear View Monitor Malfunction and Limitations.....	7-114
Rear View Monitor Operation.....	7-112
Rear View Monitor Settings.....	7-112

Recommended Lubricants and Capacities.....	2-12
Recommended Sae Viscosity Number.....	2-13
Refrigerant Label .....	2-15
Reporting Safety Defects.....	2-17

**S**

Safe exit warning (SEW) .....	7-50
Safe Exit Warning Malfunction and Limitations.....	7-54
Safe Exit Warning Operation.....	7-52
Safe Exit Warning Settings.....	7-51
Scheduled Maintenance Services .....	9-7
Maintenance Under Severe Usage Conditions.....	9-12
Normal Maintenance Schedule .....	9-8
Seat Belts .....	3-20
Additional Seat Belt Safety Precautions .....	3-28
Care of Seat Belts .....	3-30
Seat Belt Restraint System.....	3-22
Seat Belt Safety Precautions .....	3-20
Seat Belt Warning Light.....	3-21
Seats.....	3-3
Air Ventilation Seat .....	3-18
Front Seats.....	3-5
Head Restraints .....	3-12
Rear Seats.....	3-11
Safety Precautions .....	3-4
Seat Warmers.....	3-16
Smart Cruise Control (SCC) .....	7-76
Smart Cruise Control Malfunction and Limitations.....	7-87
Smart Cruise Control Operation.....	7-81
Smart Cruise Control Settings.....	7-77



---

Special Driving Conditions .....	6-57
Driving at Night .....	6-58
Driving in Flooded Areas .....	6-59
Driving in the Rain .....	6-58
Hazardous Driving Conditions .....	6-57
Highway Driving .....	6-59
Reducing the Risk of a Rollover .....	6-59
Rocking the Vehicle .....	6-57
Smooth Cornering .....	6-58
Steering Wheel .....	5-39
Electric Power Steering (EPS) .....	5-39
Heated Steering Wheel .....	5-40
Horn .....	5-41
Tilt / Telescopic Steering .....	5-40
Storage Compartment .....	5-112
Center Console Storage .....	5-112
Glove Box .....	5-113
Storage Box Under the Rear Seat .....	5-113
Sunroof .....	5-59
Automatic Reversal .....	5-61
Resetting the sunroof .....	5-62
Slide open/close .....	5-60
Sunroof Open Warning .....	5-63
Sunshade .....	5-59
Tilt Open/Close .....	5-60
Surround View Monitor (SVM) .....	7-115
Surround View Monitor Malfunction and Limitations .....	7-119
Surround View Monitor Operation .....	7-117
Surround View Monitor Settings .....	7-116

**T**

Theft-alarm System .....	5-37
Tire Pressure Monitoring System (TPMS) .....	8-9
Changing a Tire with TPMS.....	8-12
Check Tire Pressure.....	8-9
Low Tire Pressure Position and Tire Pressure Display .....	8-11
Low Tire Pressure Warning Light .....	8-11
Tire Pressure Monitoring System.....	8-10
TPMS Malfunction Indicator .....	8-12
Tire Specification and Pressure Label .....	2-14
Tires and Wheels .....	2-10/ 9-35
All Season Tires .....	9-46
Check Tire Inflation Pressure.....	9-36
Low Aspect Ratio Tires.....	9-47
Recommended Cold Tire Inflation Pressures.....	9-35
Summer Tires .....	9-46
Tire Care.....	9-35
Tire Maintenance.....	9-39
Tire Replacement .....	9-38
Tire Rotation.....	9-37
Tire Sidewall Labeling .....	9-40
Tire Terminology and Definitions .....	9-43
Tire Traction.....	9-39
Wheel Alignment and Tire Balance .....	9-38
Wheel Replacement.....	9-39
Towing.....	8-23
Towing Service.....	8-23
Trailer Towing .....	6-64
Driving with a Trailer.....	6-69
Maintenance when Towing a Trailer .....	6-72
Trailer Towing - Important Information.....	6-65
Trailer Towing Equipment .....	6-68



**V**

Vehicle Certification Label .....	2-14
Vehicle Identification Number (VIN) .....	2-14
Vehicle Load Limit .....	6-73
The Loading Information Label .....	6-74

**W**

Washer Fluid .....	9-24
Checking the Washer Fluid Level .....	9-24
Windows .....	5-54
Power Windows .....	5-55
Rear Sliding Window .....	5-58
Windshield Defrosting And Defogging .....	5-106
Automatic Climate Control System .....	5-107
Manual Climate Control System .....	5-106
Rear window defroster .....	5-108
Winter Driving .....	6-60
Snow or Icy Conditions .....	6-60
Winter Precautions .....	6-62
Wiper Blades .....	9-28
Blade Inspection .....	9-28
Blade Replacement .....	9-28
Wipers and Washers .....	5-82
Windshield Washers .....	5-84
Windshield Wipers .....	5-82

