



SHIFT\_

2013  
**FRONTIER®**



# MAKE TODAY COUNT.

## THE FEELING OF INNOVATION.

Got a major to-do list? No problem. With Frontier,<sup>®</sup> you've got a partner that's up to the biggest challenges. It's a mid-size truck with full-size attitude. 261 hp of 4.0-L V6 muscle and up to 6,500 lbs. of towing capacity to get the job done.<sup>1</sup> A fully boxed ladder frame and advanced off-road technology help get you there with ease. King Cab or Crew Cab, there's room for work or play. And with the new Desert Runner,<sup>™</sup> you can cut a trail from the highway to the hills. The 2013 Nissan Frontier. **Nissan. Innovation that excites.<sup>™</sup>**



Nissan Frontier SL Crew Cab shown in Night Armor with optional equipment.

<sup>1</sup>King Cab 4x2 models with V6. 7-pin connector-trailer wire harness and tow hitch receiver required. See Nissan Towing Guide and Owner's Manual for proper use.



**THE FEELING OF GETTING  
WHERE YOU NEED TO BE.**

Nissan Frontier PRO-4X® Crew Cab shown in Night Armor with optional equipment.

## SHAKE UP SOME SAND.

Looking for some major attitude? The new Desert Runner™ trim serves it up with looks that thrill. Amp up your cool factor with 16" 6-spoke alloy wheels, a satin chrome grille and details like fog lights and a painted rear bumper. Bilstein® off-road performance shocks and 265/75R16 BFGoodrich® Rugged Trail T/A® tires maximize your potential. And a unique bedside decal tops it off – just before you leave them in the dust.

**DESERT RUNNER™**



**Dialed in.** Get a new perspective inside as well, with high-visibility, white-faced gauges and unique embroidered sport cloth front seats, including an 8-way adjustable driver's seat. Endure even the longest trek with a standard Bluetooth® Hands-free Phone System, along with a USB input for your iPod® and steering wheel-mounted audio controls.<sup>1,2</sup>

<sup>1</sup>Availability of specific features is dependent upon the phone's Bluetooth® support. Please refer to your phone Owner's Manual for details. Bluetooth word mark and logos are owned by Bluetooth SIG, Inc., and any use of such marks by Nissan is under license. <sup>2</sup>Always give your full attention to driving. Avoid operating your iPod® in such a way that you can be distracted during vehicle operation. See dealer for details. iPod® is a registered trademark of Apple, Inc. All rights reserved. iPod® not included. BFGoodrich® is a registered trademark of Goodrich Corporation. Bilstein® is a registered trademark of ThyssenKrupp Bilstein GmbH. Rugged Trail T/A® is a registered trademark of Uniroyal Goodrich Licensing Services, Inc.

**Nissan Frontier Desert Runner King Cab** shown in Glacier White with optional equipment.

## TREAT 'EM LIKE PEBBLES.

The ultimate off-road Frontier, the PRO-4X.<sup>®</sup> Exhibit championship form with unrivaled gear, including Bilstein<sup>®</sup> off-road performance shocks, an electronic locking rear differential, 4-wheel Active Brake Limited Slip (ABLS), skid plates and 265/75R16 BFGoodrich<sup>®</sup> Rugged Trail T/A<sup>®</sup> tires. Add in unique 16" 6-spoke alloy wheels, halogen fog lights and an exclusive interior, and you've got a winning combination, inside and out.

**PRO-4X**<sup>®</sup>



**Hill start assist.** When starting on steep hills from a stop, hill start assist will help keep you from rolling backwards. It holds brake pressure for a few seconds, allowing you time to switch from the brake pedal to the accelerator.<sup>1</sup>

**Hill descent control.** When driving down a steep grade in 4WD, hill descent control can help. Just flip the switch, ease your foot from the accelerator, and this system automatically maintains speed and brake pressure to help provide a controlled descent.<sup>1</sup>

**Electronic locking rear differential.** When 4x4 mode just isn't enough, flip the switch to activate the electronic locking rear differential. This ultimate off-road feature delivers equal power to both rear wheels to boost traction and help keep your truck moving forward. When engaged, it works in conjunction with the 4-wheel Active Brake Limited Slip (ABLS). So while the locking rear differential keeps the rear wheels powered to move you ahead, ABLS helps give you the traction you need up front to help maintain steering control.



## FULLY BOXED. FULLY CAPABLE.

Four walls are stronger than three. That's why Frontier features a full-length, fully boxed ladder frame instead of the 3-sided, open C-shape rails found on some other trucks. The frame is built with super-high-tensile-strength steel in strategic areas for improved structural rigidity. This rugged material is stronger than conventional steel, for increased torsional stiffness that ultimately helps deliver enhanced performance, on- and off-road. And it's the perfect foundation to build upon with our advanced technology.



FULLY  
BOXED FRAME



CONVENTIONAL  
C-RAIL

**Anti-lock Braking System (ABS)** rapidly pumps the brakes during hard braking to help keep your wheels from locking up, thus helping you to steer around an obstacle.

**Electronic Brake force Distribution (EBD)** senses additional weight, whether it's a full cargo bed or a full tank of gas, and sends extra force to the rear brakes.

**Brake Override Technology.** Standard on every Frontier, it's designed to help slow down your vehicle and bring it to a safe stop in an emergency. It works by overriding accelerator input and reducing engine power when the accelerator and brake pedals are applied simultaneously.

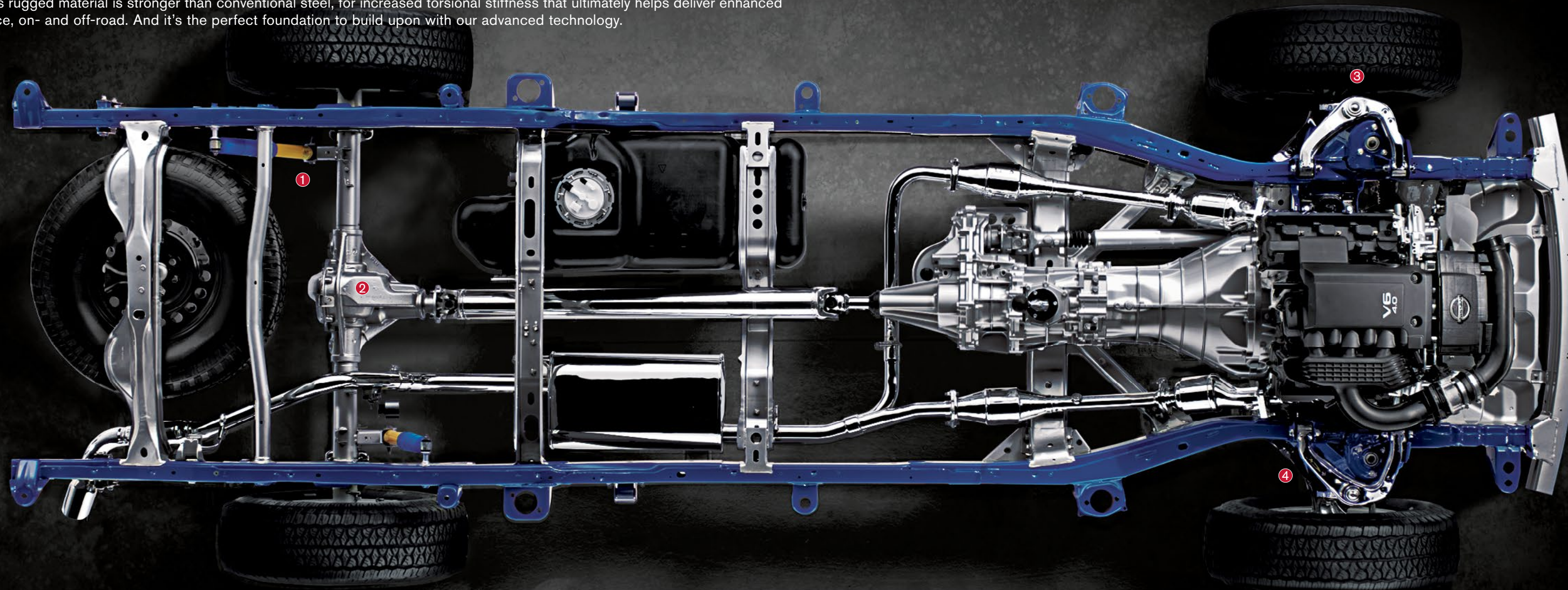

- ① Overslung rigid leaf-spring rear suspension
- ② Available heavy-duty Dana® rear axle

- ③ 4-wheel vented disc brakes with Anti-lock Braking System (ABS)
- ④ Steel double-wishbone front suspension

**Vehicle Dynamic Control (VDC).**<sup>1</sup> Also known as electronic stability control, VDC monitors driver inputs and vehicle motion and helps compensate for oversteer or understeer to help keep you on your steered path.<sup>2</sup>

**Active Brake Limited Slip (ABLS).** To help keep your wheels from spinning, Frontier offers ABLS. This system senses when a wheel begins to slip, then automatically brakes the slipping wheel (or wheels) and sends additional power to the wheels with the best traction.<sup>2</sup>

Some components have been chrome-plated or painted for display purposes only. <sup>1</sup>VDC, which should remain on when driving except when freeing the vehicle from mud or snow, cannot prevent accidents due to abrupt steering, carelessness, or dangerous driving techniques. Always drive safely. <sup>2</sup>Standard on all models. Dana® is a registered trademark of Dana Corporation.

## THE FEELING THAT THE CAR CAN COME, TOO.

Power – either you've got it, or you don't. And with Frontier, you've got it in a big way. With a 4.0-liter engine packing 261 horsepower, you won't find a more powerful V6 in its class.<sup>1</sup> And with a massive 281 lb-ft of torque, you can tow or haul just about anything you need to bring along. Maybe it's because we're a company that loves to compete – off-road, on the racetrack, even in the showroom. But wherever we win, we're happy to share the prize with you.

# 261

HORSEPOWER

# 281

LB-FT OF TORQUE

# 6,500

LBS. MAX TOWING<sup>2</sup>



**V6 power.** The 24-valve 4.0-L V6 works its magic with advanced technology, including a lightweight aluminum engine block, advanced valve timing system, variable intake and race-bred friction-reducing technology.

**A 4-cylinder that feels like a 6.** Frontier also offers a 2.5-L 4-cylinder that pumps out 152 horsepower, 171 lb-ft of torque and features a compact balancer system to deliver the smoothness of a V6.

**Gear up.** You can harness the 4-cylinder's power through a 5-speed manual transmission or an available 5-speed automatic. The V6 is available with either a 6-speed manual or 5-speed automatic transmission.

<sup>1</sup>Ward's Light Vehicle Market Segmentation. 2013 Frontier vs. 2012 Small Pickup Class. Cargo and load capacity limited by weight and distribution. Always secure all cargo. <sup>2</sup>King Cab 4x2 models with V6. 7-pin connector trailer wire harness and tow hitch receiver required. See Nissan Towing Guide and Owner's Manual for proper use.

## PUT ON THE SUBMISSION HOLD.

The Utili-track® Channel System on Frontier gives you choices few other trucks can match. Just about any type of cargo you can think of, this available system is fully equipped to help keep it secured tightly. Five channels, four cleats and a lot of thought about how people really use their trucks have created a system that's simple, rugged and offers near-infinite possibilities.

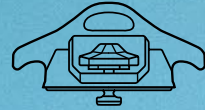

### 4 CLEATS

Frontier's four heavy-duty forged aluminum cleats easily slide in the channels for unmatched flexibility to tie things down – and the strength to hold them.

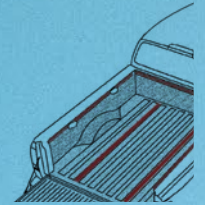

### 5 CHANNELS

Unmatched versatility comes in the form of five channels – including two channels in the floor, a feature few competitors can match. And since you can lock the cleat anywhere along the rail, Frontier makes sure you find the best position to secure whatever you bring along.

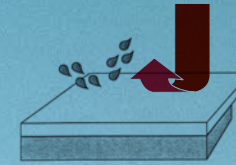

### SPRAY-ON BEDLINER

Adding to the incredible versatility of the bed, the available spray-on bedliner is applied at the factory – so you know it's done right. Fade- and weather-resistant, it's a rugged, non-skid surface that adheres directly to the bed to help prevent rusting.



### LOADS OF ACCESSORIES

There's also a full line of accessories to help you get even more out of Utili-track®, including a Sliding Tool Box,<sup>1</sup> a Sliding Bed Divider and a Sliding Bed Extender.

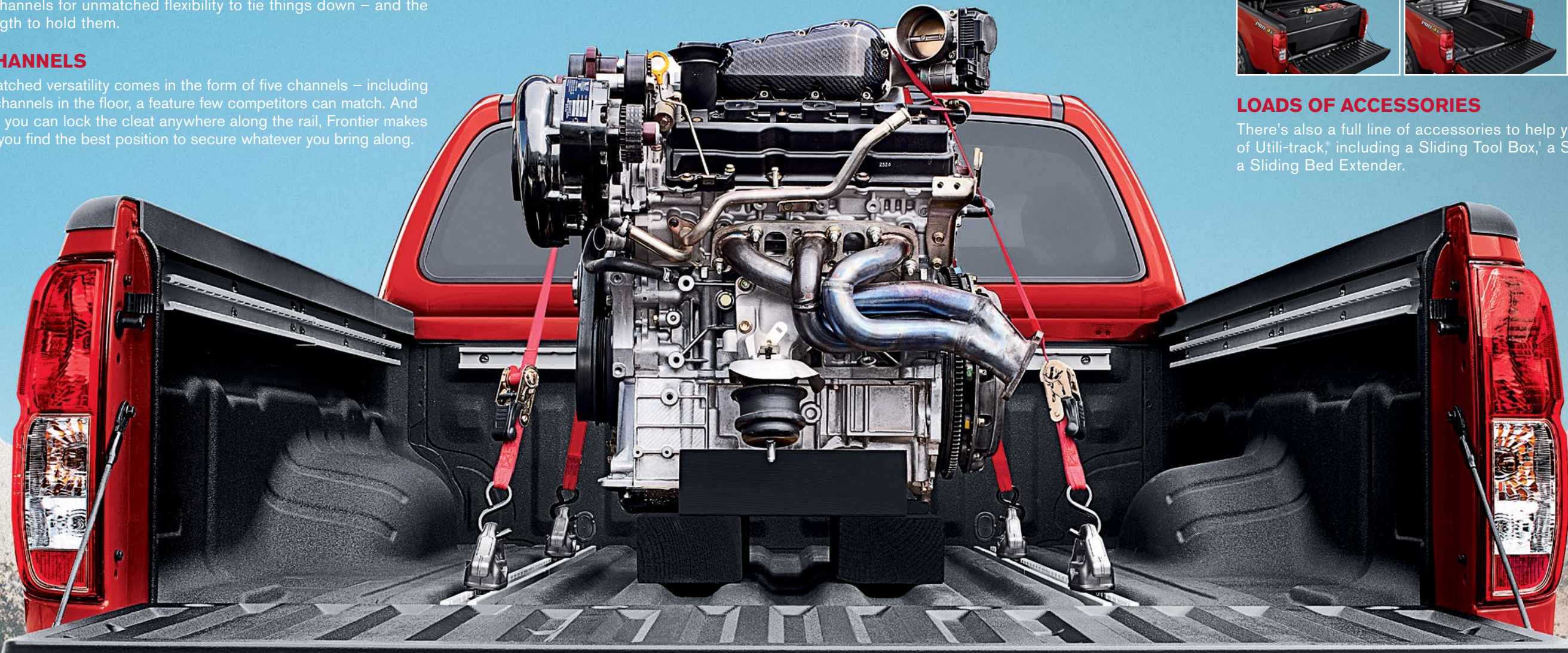





## BRING THE MAN CAVE WITH YOU.

Comfort? Entertainment? Cup holders? Check, check and check. Whether you're on the job or on the go, Frontier gives you everything you need to make your space, well, yours. A great-looking interior plus an available sporty, leather-wrapped steering wheel with controls to operate the cruise control and audio – all the better to crank up the available Rockford Fosgate-powered audio system. Available Dual Zone Automatic Temperature Control (ATC) so you and your passenger can set your own climates. And with the new available Nissan Navigation System with 5.8" touch-screen display, you can plan your next adventure without ever leaving the driver's seat.<sup>1</sup> If only everything were so convenient.



Your tunes sound better through an available Rockford Fosgate-powered audio system, featuring 10 speakers including subwoofers, and SiriusXM Satellite Radio.<sup>2</sup>



What if you could see objects behind you when parking? The available RearView Monitor automatically activates whenever you're in reverse, making it ideal for lining up your approach to a trailer. Now that's handy.<sup>3</sup>



The available Bluetooth® Hands-free Phone System lets you make and take calls with your hands on the wheel and listen to calls through the audio system's speakers.<sup>4</sup>

Nissan Frontier PRO-4X® Crew Cab shown in Graphite Leather with optional equipment.

<sup>1</sup>Never program while driving. GPS mapping may not be detailed in all areas or reflect current road regulations. <sup>2</sup>Required SiriusXM Satellite Radio, NavTraffic and NavWeather subscriptions sold separately after trial period. Installation costs, one-time activation fee, other fees and taxes will apply. NavTraffic available in select markets. Services available only to those 18 or older in the 48 contiguous states and D.C. Fees and programming subject to change. Subscriptions governed by Customer Agreement available at [siriusxm.com](http://siriusxm.com). ©2012 Sirius XM Radio Inc. Sirius, XM and all related marks and logos are trademarks of Sirius XM Radio Inc. <sup>3</sup>Parking aid/convenience feature. Cannot completely eliminate blind spots or warn of moving objects. May not detect every object. Always check surroundings before moving vehicle. Not a substitute for proper backing procedures. Always turn to check what is behind you before backing up. <sup>4</sup>Availability of specific features is dependent upon the phone's Bluetooth® support. Please refer to your phone Owner's Manual for details. The Bluetooth word mark and logos are owned by Bluetooth SIG, Inc., and any use of such marks by Nissan is under license.

NISSAN CONNECT<sup>SM 1</sup>

# YOUR MUSIC YOUR WORLD

## HOWEVER YOU WANT IT.

Why settle for just the radio? By putting the latest technologies right at your fingertips, Frontier gives you all you need for hours of endless entertainment. Rock on.

**Streaming audio via Bluetooth.\*** Want to let your passengers play DJ? Just connect a Bluetooth®-enabled audio device to stream music wirelessly, from any seat in the cabin.<sup>2</sup>

**Pandora® radio capability.** Looking for something new? Explore music based on your hand-picked favorites using Pandora® radio capability. Connect your Pandora®-equipped iPhone® through the audio system to listen to Pandora® free internet radio and use the 'thumbs up' or 'thumbs down' icons to rate songs – all right in the display.

**iPod®/USB input.** Wouldn't you like to listen to your own playlists or podcasts? With the available iPod®/USB input, you can. Plug in your iPod® or other portable MP3 player through the USB port and control it through Frontier's audio controls.<sup>3</sup>

## WHEREVER YOU ARE.

Navigate your way through the concrete canyons, or call up some friends. The NissanConnect<sup>SM</sup> system is compatible with Google® services and can even help you find that new restaurant. Now that's smart.<sup>4</sup>

**Nissan Navigation System.** Frontier's available 5.8-inch touch-screen display offers NavTraffic and NavWeather for real-time advisories to keep you on the move. Plus over five million points of interest, so you'll always have something new to discover.<sup>4,5</sup>

**Points of Interest powered by Google.\*** Find that new restaurant in a snap. NissanConnect's compatibility with Google® Points of Interest lets you search for a location, even without knowing the name or category. Once you find it, select it and you're on your way.<sup>1</sup>

**Google® Send-To-Car.** NissanConnect's compatibility with Google® Send-To-Car lets you send any address to your Nissan Navigation System using your favorite connected device, like a smartphone or computer. When you start the truck and connect to the network, the directions will be delivered and loaded into your navigation system.<sup>1,4</sup>

**Hands-free text messaging assistant.** Now you can receive and respond to text messages without ever touching your phone. With a press of a button, have your text messages read to you and answer with pre-loaded responses, all via voice recognition.<sup>6</sup>



BLUETOOTH<sup>7</sup>



IPOD<sup>8</sup>



NAVIGATION MAP



WEATHER



<sup>1</sup>Certain remote functions require compatible phone, not included with vehicle. Cellular network and vehicle services provided by independent companies not within Nissan's control. Cellular network not available in all areas. Certain connected vehicle services, including but not limited to Points of Interest and Send-to-Car, may require subscription and owner consent to activate. Should service provider terminate/restrict service, service may be suspended or terminated without notice or liability to Nissan and/or its agents. Nissan not responsible for any equipment replacement or upgrades, or associated costs, that may be required for continued operation due to service changes. Standard text rates, voice minutes, roaming charges and/or data usage may apply. <sup>2</sup>Availability of specific features is dependent upon the phone's Bluetooth® support. Please refer to your phone Owner's Manual for details. The Bluetooth word mark and logos are owned by Bluetooth SIG, Inc., and any use of such marks by Nissan is under license. <sup>3</sup>Driving is serious business and requires your full attention. Do not operate any devices connected to the USB or auxiliary audio input jack while driving. <sup>4</sup>Never

program while driving. GPS mapping may not be detailed in all areas or reflect current road regulations. <sup>5</sup>Required SiriusXM Satellite Radio, NavTraffic and NavWeather subscriptions sold separately after trial period. Installation costs, one-time activation fee, other fees and taxes will apply. NavTraffic available in select markets. Services available only to those 18 or older in the 48 contiguous states and D.C. Fees and programming subject to change. Subscriptions governed by Customer Agreement available at [siriusxm.com](http://siriusxm.com). ©2012 Sirius XM Radio Inc. Sirius, XM and all related marks and logos are trademarks of Sirius XM Radio Inc. <sup>6</sup>Use the text messaging feature after stopping your vehicle in a safe location. If you have to use the feature while driving, exercise extreme caution at all times so full attention may be given to vehicle operation. Google® is a registered trademark of Google Inc. iPod® is a registered trademark of Apple, Inc. All rights reserved. iPod not included. Pandora® is a registered trademark of Pandora Media, Inc.



## LOAD IT ALL IN.

**Frontier Crew Cab.** Space, or comfort? Why not both? Forward-hinged doors make for easy entry, while a 60/40 split rear bench allows seating for five and folds easily to create a large, flat surface. Or you can flip up the rear seat cushions for more storage room. There's also an under-seat storage tray that's removable for even greater flexibility.

FOLDS FLAT

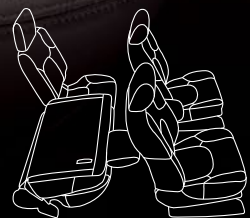

FLIPS UP



**Safety. First and foremost.** In Frontier, making your protection our priority starts with 6 standard air bags, including seat-mounted side-impact supplemental air bags and roof-mounted curtain side-impact supplemental air bags. The advanced front seat belts on every Frontier feature pretensioners that automatically help tighten the belts when the front air bags deploy.<sup>1</sup> And if your body puts too much force on the belt, load limiters give a bit. During a rear-end impact, front-seat Active Head Restraints move up and toward you to meet your head part of the way, helping close the gap and reducing the chance of whiplash.

<sup>1</sup>Please keep in mind that air bags are a supplemental system and must always be used in conjunction with a seat belt. Even with the occupant-classification sensor, rear-facing child restraints should not be placed in the front-passenger's seat. Also, all children 12 and under should ride in the rear seat properly secured in child restraints, booster seats, or seat belts according to their size. And please see your King Cab Owner's Manual for specific information about the safest way to secure a child restraint in a Frontier King Cab. Inflated air bags shown for illustration purposes only; actual coverage area may differ. Air bags deflate after deployment.

**Nissan Frontier SL Crew Cab** shown in Steel Leather.



Nissan Frontier PRO-4X® King Cab shown in Graphite Steel Cloth.

## OPEN UP WIDE.

Frontier King Cab. Smart design means rear doors that give your passengers easy access to the cabin. And with no B-pillars, you also get a huge opening for larger-than-life items. The two rear seats face forward, or flip up and out of the way to reveal a large open space for cargo.

## FLEXIBLE STORAGE FOR ALL.

The front-passenger seat folds down<sup>1</sup> to carry larger items or to make a flat surface for writing checks other trucks can't cash. Storage options, including (1) removable storage under the rear seats, (2) a multi-level center console and (3) a dual-level glove compartment, make sure your gear is safe and out of sight of prying eyes.



<sup>1</sup>See Specifications section for availability. Cargo and load capacity limited by weight and distribution. Always secure all cargo.



①

②

③



# STEP UP YOUR GAME.

## GENUINE NISSAN ACCESSORIES. IMPRESS. CONNECT. PROTECT. ORGANIZE.

Every Genuine Nissan Accessory is: custom-fit, custom-designed and durability-tested; backed by Nissan's 3-year/36,000-mile limited warranty; and can be financed when installed by dealer at time of purchase.<sup>1</sup>

For more information and to shop online for Genuine Nissan Accessories, go to [parts.NissanUSA.com](http://parts.NissanUSA.com).

- A. Fog Lights**  
Help light your way in rain, sleet or snow.
- B. Side-window Deflectors**  
Wind is great, but not in your face.
- C. Tow Hook**  
Extra strength for sticky situations.
- D. Body Side Moldings and Step Rails (sold separately)**  
Protect your doors and get a lift.
- E. Hood Protector**  
Give your hood a fighting chance.
- F. PRO-4X® Carpeted Floor Mats**  
Stylish. Plush. Protected.
- G. All-season Floor Mats**  
Don't let the muck mess up your truck.
- H. Splash Guards**  
Show that puddle who's boss.



<sup>1</sup>Covered by Nissan's Limited Warranty on Genuine Nissan Accessories for the longer of 12 months/12,000 miles or the remaining period under the 3-year/36,000-mile Nissan New Vehicle Limited Warranty. Terms and conditions apply. See Warranty Information Booklet for details. Cargo and load capacity limited by weight and distribution. Always secure all cargo. Heavy loading of the truck with cargo, especially on the roof, will affect handling and stability of the vehicle.

Nissan Frontier PRO-4X® Crew Cab with PRO-4X Luxury Package shown in Brilliant Silver with Fog Lights (standard on PRO-4X), Tow Hook (standard on 4x4 models), Splash Guards (standard on PRO-4X), Step Rails, Body Side Moldings, Hood Protector and Side-window Deflectors.

## S



KING CAB



CREW CAB

- 2.5-liter 4-cylinder engine
- 5-speed manual transmission
- Active Brake Limited Slip (ABLS)
- 4-wheel Anti-lock Braking System (ABS)
- Full-length, fully boxed ladder frame
- Rear access doors
- Fold-flat front-passenger seat
- Second-row under-seat storage
- Vehicle Dynamic Control (VDC)
- Tire Pressure Monitoring System (TPMS)
- Six standard air bags

### Crew Cab adds:

- 261-hp 4.0-liter DOHC 24-valve V6 engine
- 6-speed manual transmission
- Four full-size doors with seating for five
- AM/FM/CD audio system and air conditioning
- Tilt steering column

## SV 4-cyl. / V6



KING CAB



CREW CAB

### SV 4-cylinder includes S equipment plus:

- 16" Aluminum-alloy wheels with P265/70R16 OWL all-season tires
- Body-color front bumper
- Bed rail caps
- Air conditioning
- Bluetooth® Hands-free Phone System
- AM/FM/CD audio system with 4.3-inch color display
- SiriusXM Satellite Radio
- Illuminated steering wheel-mounted audio controls
- USB connection port for iPod® interface and other compatible devices
- Tilt steering column
- Sliding rear window (King Cab only)
- Sun visors with vanity mirrors and extension

### SV V6 includes SV 4-cyl. equipment plus:

- 4.0-liter DOHC 24-valve V6
- 6-speed manual transmission
- Front tow hook – 4x4 only

### Crew Cab adds:

- Four full-size doors with seating for five
- Optional Long Bed

## DESERT RUNNER™



KING CAB



CREW CAB

### Includes SV 4-cyl. equipment plus:

- 4.0-liter DOHC 24-valve V6
- 5-speed automatic transmission
- 16" Aluminum-alloy wheels
- P265/75R16 BFGoodrich® Rugged Trail T/A® tires
- Bilstein® off-road performance shocks
- Fog lights
- Satin chrome grille
- Body-color rear bumper
- Multi-functional trip computer
- 8-way manual driver's seat
- Frontier embroidered cloth seat trim
- Desert Runner decals

### Crew Cab adds:

- Four full-size doors with seating for five

## PRO-4X®



KING CAB



CREW CAB

### Includes SV V6 equipment plus:

- Bilstein® off-road performance shocks
- Electronic locking rear differential
- Clutch start/cancel (manual transmission only)
- Skid plates (oil pan, fuel tank and transfer case)
- 16" Machined-finish aluminum-alloy wheels
- P265/75R16 BFGoodrich® Rugged Trail T/A® tires
- Automatic on/off headlights and fog lights
- Utili-track® Channel System
- Factory-applied spray-on bedliner
- Satin chrome grille and body-color rear bumper
- PRO-4X bed decal
- RearView Monitor and Rear Sonar System
- Rockford Fosgate-powered audio system (Crew Cab only)
- Auto-dimming rearview mirror
- Multi-functional trip computer
- Dual Zone Automatic Temperature Control (ATC)
- PRO-4X embroidered cloth seat trim
- White contrast interior stitching and white-faced gauges

## SL



CREW CAB

### Includes SV V6 equipment plus:

- 5-speed automatic transmission
- 18" Aluminum-alloy wheels
- Automatic on/off headlights and fog lights
- Utili-track® Channel System
- Factory-applied spray-on bedliner
- Chrome outside mirrors and door handles
- Step rails
- NissanConnect™ with Navigation, including 5.8-inch color touch-screen monitor and voice recognition
- NavTraffic and NavWeather
- POIs powered by Google® and Google® Send-To-Car
- Rockford Fosgate-powered audio system
- Pandora® radio capability
- Streaming audio via Bluetooth® wireless technology
- Hands-free text messaging assistant
- RearView Monitor and Rear Sonar System
- Dual Zone Automatic Temperature Control (ATC)
- Auto-dimming rearview mirror with HomeLink® Universal Transceiver
- Leather-appointed seats
- 8-way power adjustable driver's seat
- 4-way power adjustable front-passenger's seat
- Leather-wrapped steering wheel

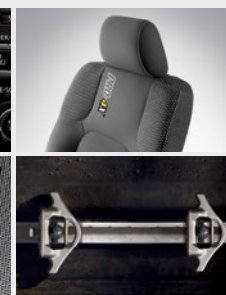



## DIMENSIONS/CAPACITIES/WEIGHTS/MPG

Dimensions		
Exterior – Inches	King Cab	Crew Cab Standard/Long Bed
Wheelbase	125.9	125.9/139.9
Overall length	205.5	205.5/219.4
Overall width	72.8	72.8
Overall height	68.7 – 69.7	70.1 – 73.9
Track width (front/rear)	61.8	61.8
Bed length	73.3	59.5/73.3
Bed width	61.4	61.4
Bed depth	18.0	18.0
Vehicle clearance	PRO-4X King Cab	PRO-4X Crew Cab
Ground clearance at rear differential	8.7" – 10.1"	9.8" – 10.1"
Angle of approach; V6 models – 4x2	30.5°	30.5°
– 4x4	31.5° <sup>1</sup>	31.5° <sup>1</sup>
Angle of departure; V6 models – 4x2	22.1°	22.1°
– 4x4	22.6° <sup>2</sup>	22.6° <sup>2</sup>
Break-over angle; V6 models	19.5° – 20.6°	19.5° – 20.6°
Interior – Inches	King Cab	Crew Cab Standard/Long Bed
Head room without moonroof	39.7/38.3	40.0/38.7
Leg room	42.4/25.4	42.4/33.6
Hip room	55.8/55.0	55.6/58.0
Shoulder room	58.3/54.9	58.3/58.3

Maximum Payload – Lbs.		
4-cylinder King Cab – 4x2	S	SV
Manual transmission	971	931
Automatic transmission	932	913

V6 King Cab – 4x2	S	SV	DESERT RUNNER	PRO-4X	SL
Manual transmission	–	1,524	–	–	–
Automatic transmission	–	1,447	1,385	–	–

King Cab – 4x4	S	SV	DESERT RUNNER	PRO-4X	SL
Manual transmission	–	1,355	–	1,235	–
Automatic transmission	–	1,379	–	1,215	–

Crew Cab – 4x2	S	SV	DESERT RUNNER	PRO-4X	SL
Manual transmission	1,457	1,422	–	–	–
Automatic transmission	1,481	1,481	1,264	–	1,350

Crew Cab – 4x4	S	SV	DESERT RUNNER	PRO-4X	SL
Manual transmission	1,251	1,255	–	1,098	–
Automatic transmission	1,385	1,390	–	1,078	1,251

Crew Cab Long Bed – 4x2	S	SV	DESERT RUNNER	PRO-4X	SL
Manual transmission	–	–	–	–	–
Automatic transmission	–	1,388	–	–	1,252

Crew Cab Long Bed – 4x4	S	SV	DESERT RUNNER	PRO-4X	SL
Manual transmission	–	–	–	–	–
Automatic transmission	–	1,260	–	–	1,120

Maximum Towing – Lbs. <sup>3</sup>		
	King Cab	Crew Cab
4-cylinder – 4x2	3,500	–
V6 – 4x2 (4x4)	6,500 (6,300)	6,300 (6,100)

Capacities		
	King Cab	Crew Cab
Seating capacity	4	5
Interior passenger volume (cu. ft.)	87.7	101.1
Fuel tank (gals.)	21.1	21.1

Curb Weights – Lbs.		
4-cylinder King Cab – 4x2	S	SV
Manual transmission	3,708	3,753
Automatic transmission	3,760	3,771

V6 King Cab – 4x2	S	SV	DESERT RUNNER	PRO-4X	SL
Manual transmission	–	4,175	–	–	–
Automatic transmission	–	4,140	4,215	–	–

King Cab – 4x4	S	SV	DESERT RUNNER	PRO-4X	SL
Manual transmission	–	4,327	–	4,333	–
Automatic transmission	–	4,311	–	4,406	–

Crew Cab – 4x2	S	SV	DESERT RUNNER	PRO-4X	SL
Manual transmission	4,219	4,281	–	–	–
Automatic transmission	4,271	4,250	4,336	–	4,409

Crew Cab – 4x4	S	SV	DESERT RUNNER	PRO-4X	SL
Manual transmission	4,381	4,443	–	4,475	–
Automatic transmission	4,454	4,433	–	4,548	4,594

Crew Cab Long Bed – 4x2	S	SV	DESERT RUNNER	PRO-4X	SL
Manual transmission	–	–	–	–	–
Automatic transmission	–	4,343	–	–	4,507

Crew Cab Long Bed – 4x4	S	SV	DESERT RUNNER	PRO-4X	SL
Manual transmission	–	–	–	–	–
Automatic transmission	–	4,557	–	–	4,725

2013 EPA Fuel Economy Estimates – City/Hwy		
	4-cylinder	V6
Manual transmission – 4x2 (4x4)	19/23 (N/A)	16/22 (16/21)
Automatic transmission – 4x2 (4x4)	17/23 (N/A)	16/22 (15/21)

<sup>1</sup>32.6° on PRO-4X. <sup>2</sup>23.3° on PRO-4X. <sup>3</sup>9-pin connector trailer wire harness and tow hitch receiver required.

<sup>4</sup>Subject to vehicle tow/payload capacity. See Nissan Towing Guide and Owner's Manual for proper use.

<sup>5</sup>Required SiriusXM Satellite Radio, NavTraffic and NavWeather subscriptions sold separately after trial period. Installation costs, one-time activation fee, other fees and taxes will apply. NavTraffic available in select markets. Services available only to those 18 or older in the 48 contiguous states and D.C. Fees and programming subject to change. Subscriptions governed by Customer Agreement available at [siriusxm.com](http://siriusxm.com). ©2012 Sirius XM Radio Inc. Sirius, XM and all related marks and logos are trademarks of Sirius XM Radio Inc. The Bluetooth® word mark and logos are owned by Bluetooth SIG, Inc., and any use of such marks by Nissan is under license. Google® is a registered trademark of Google Inc. Pandora® is a registered trademark of Pandora Media.

## PACKAGES

<b>S Preferred Package (King Cab Only)</b>
AM/FM/CD audio system
Air conditioning

<b>SV V6 Value Truck Package</b>
RearView Monitor
Rear Sonar System
Dual Zone Automatic Temperature Control (ATC)
Six speakers (King Cab only)
Auto-dimming rearview mirror, digital compass and outside temperature display
Factory-applied spray-on bedliner
Utili-track® Channel System with 4 tie-down cleats
Fog lights
Vehicle Security System
In-cabin microfilter
Carpeted floor mats
Sliding bed extender
Tow hitch receiver, Class IV <sup>4</sup>

<b>PRO-4X Luxury Package (Crew Cab Only)</b>
PRO-4X embroidered leather-appointed seats
8-way power adjustable driver's seat
4-way power adjustable front-passenger's seat
Heated front seats and outside mirrors
Rear fold-down center armrest
NissanConnect <sup>SM</sup> with Navigation including 5.8-inch color touch-screen monitor and voice recognition
NavTraffic and NavWeather <sup>5</sup>
POIs powered by Google® and Google® Send-To-Car
Pandora® radio capability
Streaming audio via Bluetooth® wireless technology
Hands-free text messaging assistant
Power sliding glass moonroof
Roof rack with crossbars
Fold-flat front-passenger's seat is deleted with this package.

<b>SL Moonroof Package</b>
Power sliding glass moonroof

This brochure is intended for general descriptive and informational purposes only. It is subject to change and does not constitute an offer, representation or warranty (express or implied) by Nissan North America, Inc. Interested parties should confirm the accuracy of any information in this brochure as it relates to a vehicle directly with Nissan North America, Inc., before relying on it to make a purchase decision. Nissan North America, Inc., reserves the right to make changes, at any time, without prior notice, in prices, colors, materials, equipment, specifications, and models and to discontinue models or equipment. Due to continuous product development and other pre- and post-production factors, actual vehicle, materials and specifications may vary from this brochure. Some vehicles shown with optional equipment. See the actual vehicle for complete accuracy. Availability and delivery times for particular models or equipment may vary. Specifications, options and accessories may differ in Hawaii, U.S. territories and other countries. For additional information on availability, options or accessories, see your Nissan dealer or contact Nissan North America, Inc. At [NissanUSA.com](http://NissanUSA.com), you'll find virtual product demonstrations, a way to "build your own Nissan," a dealer locator, and more information about key Nissan support services. Or if you'd prefer, call **1-800-NISSAN-3** for answers to specific questions about Frontier or any other Nissan vehicle. The Nissan names, logos, product names, feature names, and slogans are trademarks owned by or licensed to Nissan Motor Co. Ltd. and/or its North American subsidiaries. **Tread Lightly!® Please. Always wear your seat belt, and please don't drink and drive.** ©2013 Nissan North America, Inc.



**Buying and owning a Nissan is like driving one: quick, convenient, confidence-inspiring.**

**Nissan Motor Acceptance Corporation.** Whether you're buying or leasing, you'll find attractive rates and flexible terms to make your purchase more accessible.

**New Vehicle Limited Warranties.** Protection for your new Nissan includes 3-year/36,000-mile basic coverage and 5-year/60,000-mile powertrain coverage. Terms, conditions and exclusions apply. See Warranty Information Booklet for complete details.

**Security+Plus.®** For additional peace of mind, a variety of extended service plans lets you tailor the coverage to your driving habits.

**Maintenance+Plus.®** This extended plan ensures your Nissan will receive up to 17 different services and over 33 different inspection items at each visit, using the most up-to-date diagnostic equipment available.

**Genuine Nissan Parts.** When it comes time for service, any necessary replacement parts will be made using Genuine Nissan new or remanufactured parts, or Nissan-approved parts. And they're the only parts to carry Nissan's factory-backed limited warranty.

Nissan's philosophy toward the environment, "Seeking a symbiosis of people, vehicles and nature," describes our ideal for a sustainable mobile society, now and in the future. We launched the Nissan Green Program with specific objectives to realize this goal, and we are pursuing it energetically. For more information, log on to [NissanUSA.com/green](http://NissanUSA.com/green)





PAINT SELECTIONS



**Lava Red EAF**

	S	SV	DESERT RUNNER	PRO-4X	SL
STEEL CLOTH		<sup>1</sup>			
STEEL LEATHER					<input type="checkbox"/>
GRAPHITE CLOTH		<sup>2</sup>			
GRAPHITE STEEL CLOTH			<input type="checkbox"/>	<input type="checkbox"/>	
GRAPHITE LEATHER				<input type="checkbox"/>	



**Night Armor K26**

	S	SV	DESERT RUNNER	PRO-4X	SL
STEEL CLOTH		<input type="checkbox"/>			
STEEL LEATHER					<input type="checkbox"/>
GRAPHITE CLOTH		<sup>2</sup>			
GRAPHITE STEEL CLOTH			<input type="checkbox"/>	<input type="checkbox"/>	
GRAPHITE LEATHER				<input type="checkbox"/>	



**Cayenne Red NAH**

	S	SV	DESERT RUNNER	PRO-4X	SL
STEEL CLOTH		<input type="checkbox"/>			
BEIGE CLOTH		<input type="checkbox"/>			
BEIGE LEATHER					<input type="checkbox"/>
GRAPHITE CLOTH		<sup>2</sup>			



**Brilliant Silver K23**

	S	SV	DESERT RUNNER	PRO-4X	SL
STEEL CLOTH	<input type="checkbox"/>	<sup>1</sup>			
STEEL LEATHER					<input type="checkbox"/>
GRAPHITE CLOTH	<input type="checkbox"/>	<sup>2</sup>			
GRAPHITE STEEL CLOTH			<input type="checkbox"/>	<input type="checkbox"/>	
GRAPHITE LEATHER				<input type="checkbox"/>	



**Super Black KH3**

	S	SV	DESERT RUNNER	PRO-4X	SL
STEEL CLOTH	<input type="checkbox"/>	<sup>1</sup>			
STEEL LEATHER					<input type="checkbox"/>
BEIGE CLOTH		<input type="checkbox"/>			
BEIGE LEATHER					<input type="checkbox"/>
GRAPHITE CLOTH		<sup>2</sup>	<sup>2</sup>		
GRAPHITE STEEL CLOTH			<input type="checkbox"/>	<input type="checkbox"/>	
GRAPHITE LEATHER				<input type="checkbox"/>	



**Metallic Blue B17**

	S	SV	DESERT RUNNER	PRO-4X	SL
STEEL CLOTH		<input type="checkbox"/>			
STEEL LEATHER					<input type="checkbox"/>
GRAPHITE CLOTH		<sup>2</sup>			
GRAPHITE STEEL CLOTH			<input type="checkbox"/>	<input type="checkbox"/>	
GRAPHITE LEATHER				<input type="checkbox"/>	



**Glacier White QAK**

	S	SV	DESERT RUNNER	PRO-4X	SL
STEEL CLOTH	<input type="checkbox"/>	<sup>1</sup>			
STEEL LEATHER					<input type="checkbox"/>
BEIGE CLOTH		<input type="checkbox"/>			
BEIGE LEATHER					<input type="checkbox"/>
GRAPHITE STEEL CLOTH			<input type="checkbox"/>	<input type="checkbox"/>	
GRAPHITE LEATHER				<input type="checkbox"/>	



**Graphite Blue RAQ**

	S	SV	DESERT RUNNER	PRO-4X	SL
STEEL CLOTH		<input type="checkbox"/>			
STEEL LEATHER					<input type="checkbox"/>
GRAPHITE CLOTH		<sup>2</sup>			
GRAPHITE STEEL CLOTH			<input type="checkbox"/>	<input type="checkbox"/>	
GRAPHITE LEATHER				<input type="checkbox"/>	

FABRIC SELECTIONS

**S Steel Cloth<sup>2</sup>**



**S Graphite Cloth<sup>2</sup>**



**SV Graphite Cloth<sup>2</sup>**



**SV Beige Cloth<sup>2</sup>**



**S/SV Steel Cloth<sup>1</sup>**



**SV Beige Cloth<sup>1</sup>**



**Desert Runner Graphite Steel Cloth**



**PRO-4X Graphite Steel Cloth**



**PRO-4X Graphite Leather<sup>1</sup>**



**SL Steel Leather<sup>1</sup>**



**SL Beige Leather<sup>1</sup>**



**PICK A COLOR, ANY COLOR.**

You've decided which Frontier you want, now here comes the best part: deciding what it's going to look like. Select your favorite color and then pick from the available interiors based on the model of your choice.

- Standard
- Part of PRO-4X Luxury Package

<sup>1</sup>Crew Cab. <sup>2</sup>King Cab.

## Nissan. Innovation that excites.<sup>TM</sup>

### NISSAN FRONTIER<sup>®</sup>

Shouldn't you drive something you love? Absolutely. And that's what inspires our innovation. We look at every part of your drive and ask how can we make this better, smarter and more fun. So when you get in your new Frontier, you'll feel how exciting the answers can be:

**Start with strength.** A full-length, fully boxed ladder frame means full-size toughness in a mid-size truck. Go ahead and dish it out. Frontier can take it.

**Lock it down.** The first of its kind, Frontier's available Utili-track<sup>®</sup> system has five channels and four heavy-duty cleats to put your cargo on lockdown. And keep it there.<sup>1</sup>

**Get a grip.** Frontier's available electronic locking rear differential is ultimate off-road technology that takes you to the next level of 4x4 capability.

**Proceed with power.** 261 hp. 281 lb-ft of torque. Tow it, carry it, move it out. You won't find a more powerful V6 in a mid-size truck.

Los folletos de Nissan también están disponibles en español. Para descargar el PDF, visita:  
**[NissanUSA.com/folletos-espanol](http://NissanUSA.com/folletos-espanol)**

And follow Nissan on:



SHIFT\_

visit **[NissanUSA.com/frontier](http://NissanUSA.com/frontier)**

<sup>1</sup>Cargo and load capacity limited by weight and distribution. Always secure all cargo. Facebook<sup>®</sup> is a registered trademark of Facebook, Inc. Twitter<sup>®</sup> is a registered trademark of Twitter, Inc. YouTube<sup>®</sup> is a registered trademark of Google, Inc.