

LT™ SERIES



THE NEW
INTERNATIONAL® LT™ SERIES.



**THE NEW INTERNATIONAL LT SERIES
DELIVERS EVERYTHING YOU ASKED
FOR IN A DRIVER'S TRUCK.**

LT
INTERNATIONAL



**THEN WE TOOK
IT FURTHER.**



Introducing the LT Series from International Truck, the most driver-centric, fuel-efficient, uptime-focused truck we've ever delivered. Hundreds of driver recommendations shaped its design. From its new, ergonomically advanced interior and instrument panel to major enhancements in visibility and aerodynamics, the new LT Series is designed and engineered to keep drivers more comfortable and productive for the long haul. It's part of an uncompromising commitment to put our customers' business needs at the heart of every decision we make – a philosophy we call DriverFirst™.



AN LT SERIES CONFIGURATION FOR EVERY APPLICATION.



Day Cab

56\" Low Roof Sleeper

56\" Hi-Rise Sleeper*

73\" Sky-Rise Sleeper

73\" Hi-Rise Sleeper

* Shown with optional sun visor



DRIVERFIRST™ - FROM CONCEPT TO REALITY.

From the very beginning, priority #1 for the LT Series was to design a truck that drivers would really want to drive. To achieve this goal, we turned to the people who know driving best - real truck drivers.

These professionals gave us honest, priceless input over numerous research sessions and driver clinics. Then we set about redesigning, fine-tuning and retesting until drivers agreed, "this is the truck I've always wanted to drive."

That's how the LT Series became the most driver-centric truck on the road today. With more intuitive controls, enhanced visibility, a quieter cab, critical information at your fingertips and dozens of other smart features that help keep a driver comfortable and in control over the long haul.

International also utilizes premium soft touch vinyl interior panels throughout the vehicle, which minimizes the need for hard to clean, odor and moisture trapping woven panels.





DRIVERFIRST IN EVERY DETAIL.

Every detail inside the LT Series cab has been carefully designed, measured and clinic-tested to optimally benefit the driver. All-new gauges received numerous tests and refinements to optimize their readability, usability and positioning so key information and alerts are precisely where they need to be to view without distraction. The available new premium gauge cluster features a customizable digital display that lets drivers intuitively select the information they prefer in a variety of situations.



A customizable digital display in the premium gauge cluster provides a wealth of information for the driver, including:

- ▶ Real-time fuel economy
- ▶ Axle load*
- ▶ Custom gauge settings*
- ▶ Safety indicators*
- ▶ Digital speedometer
- ▶ Tire pressure*



Intuitive controls allow you to easily navigate between digital screens.

Back Button - navigate to previous page/sub category and then to main home screen

Navigation Button - navigate up and down to move within categories, navigate left or right to access the main menu and to move from one category to another

OK/Reset Button - select a highlighted category or hold for 3 seconds to reset the item

* When added with optional feature code for required sensors.

Driver safety is always a priority. What you prioritize is up to you with a range of available **passive and active safety systems**. Bendix Wingman Advanced collision mitigation now comes standard on the LT Series. With the optional Bendix Wingman Fusion, the system integrates adaptive cruise control, lane departure warning (pictured here), over-speed alert and stationary vehicle braking, or select from a number of proven stand-alone safety systems to meet your needs.

The color, illumination, legibility and even the type font and size of gauges is designed to deliver optimal viewing in varying light conditions, maximizing alertness and minimizing eye fatigue.



NEW SHIFTER



▶ The innovative new shifter is mounted on the steering column, allowing you to easily reach and smoothly operate shifting and engine braking while keeping your eyes on the road and your hands on the wheel.



THE ART AND SCIENCE OF BOOSTING DRIVER PRODUCTIVITY.

The LT Series cab design included the meticulous study of over 500 interaction points between the driver and truck to address every possible aspect of ergonomics, from what a driver sees to the way he moves and how he can best handle virtually any situation - whether it's climbing into the cab, cruising comfortably or getting a good night's rest.



It's estimated that 20-30% of truck accidents are vision related. That's why the LT Series provides impressive forward and lateral visibility. Cab doors have been redesigned with a lower bottom glass edge and no vent window seam for enhanced visibility and reduced blind spots.

DIRECT VISIBILITY

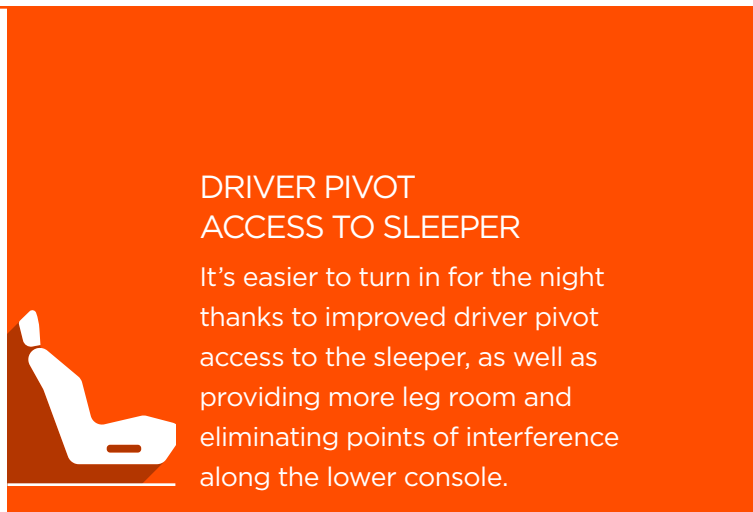

DRIVER PIVOT ACCESS TO SLEEPER

It's easier to turn in for the night thanks to improved driver pivot access to the sleeper, as well as providing more leg room and eliminating points of interference along the lower console.

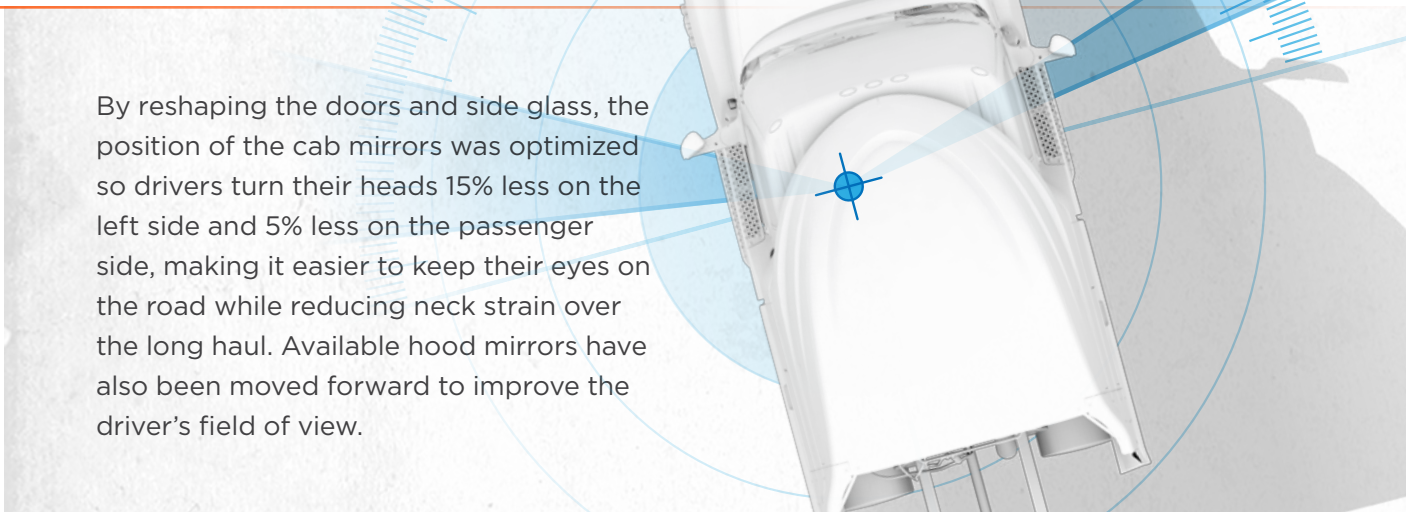

By reshaping the doors and side glass, the position of the cab mirrors was optimized so drivers turn their heads 15% less on the left side and 5% less on the passenger side, making it easier to keep their eyes on the road while reducing neck strain over the long haul. Available hood mirrors have also been moved forward to improve the driver's field of view.

INDIRECT VISIBILITY



All-new door panels help increase hip and elbow room while providing a more comfortable place to rest your arm. The new full-grip interior handle makes doors easier to open and close, while new door pockets offer easier access to the driver's log or manifest.

Studies show that one of the largest causes of driver injury occurs from slip and falls while entering and exiting the cab. That's why we improved ingress and egress through wider opening doors, redesigned cab steps and grab handles that are precisely positioned for proper 3-point access.

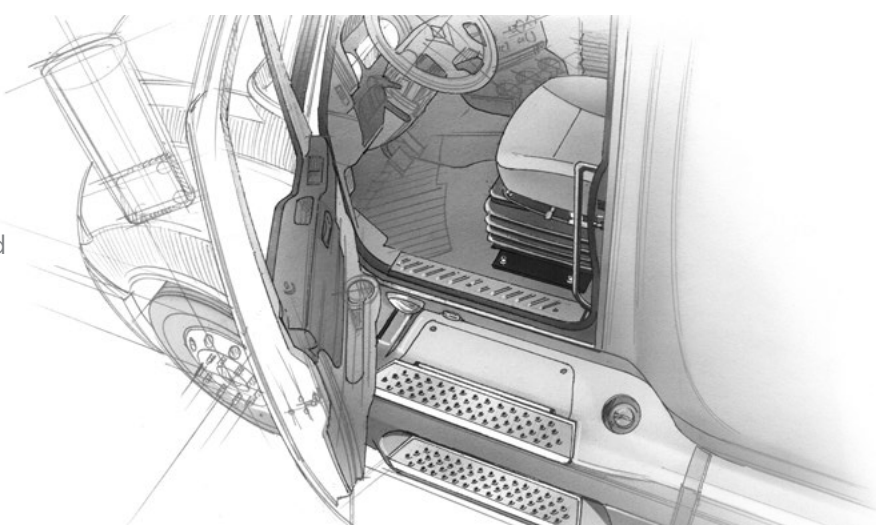



KEEPING YOU ON THE ROAD TO PROFITABILITY.

Uptime is more than a word in the development of the LT Series, it's an unwavering commitment to deliver a truck that is as reliable and easy to service as the road is long.



- ▶ Available new LED headlamps and fog lamps deliver brighter light pattern and intensity. Tough new polycarbonate lenses protect against breakage.
- ▶ Driver controls and instrumentation are based on robust industry-standard SAE J1939 electrical architecture, with a new cluster and switches designed to keep drivers focused and maximize uptime.
- ▶ Steering wheel control labels are laser-etched instead of painted for maximum readability and durability.
- ▶ Key interior fasteners are exposed for more intuitive access and easier servicing.
- ▶ The powerful, all-new HVAC system employs advanced automotive heating and cooling technology to deliver optimal comfort and reliability. The system endured rigorous testing in extreme temperatures to deliver best-in-class visibility and comfort.
- ▶ A new max defrost feature in the HVAC system helps clear windows faster in colder climates, providing quicker, clearer visibility for increased uptime and less waiting.
- ▶ Cab wiring includes all-new harnessing and an all-new in-cab power distribution module that's inside the cab and away from the elements.
- ▶ A new single canister after-treatment system is up to 60% smaller and 40% lighter than the system it replaces, with better heat management to help improve fuel economy and greater ash retention to stretch out time between service intervals. The system is also simplified for quicker servicing.

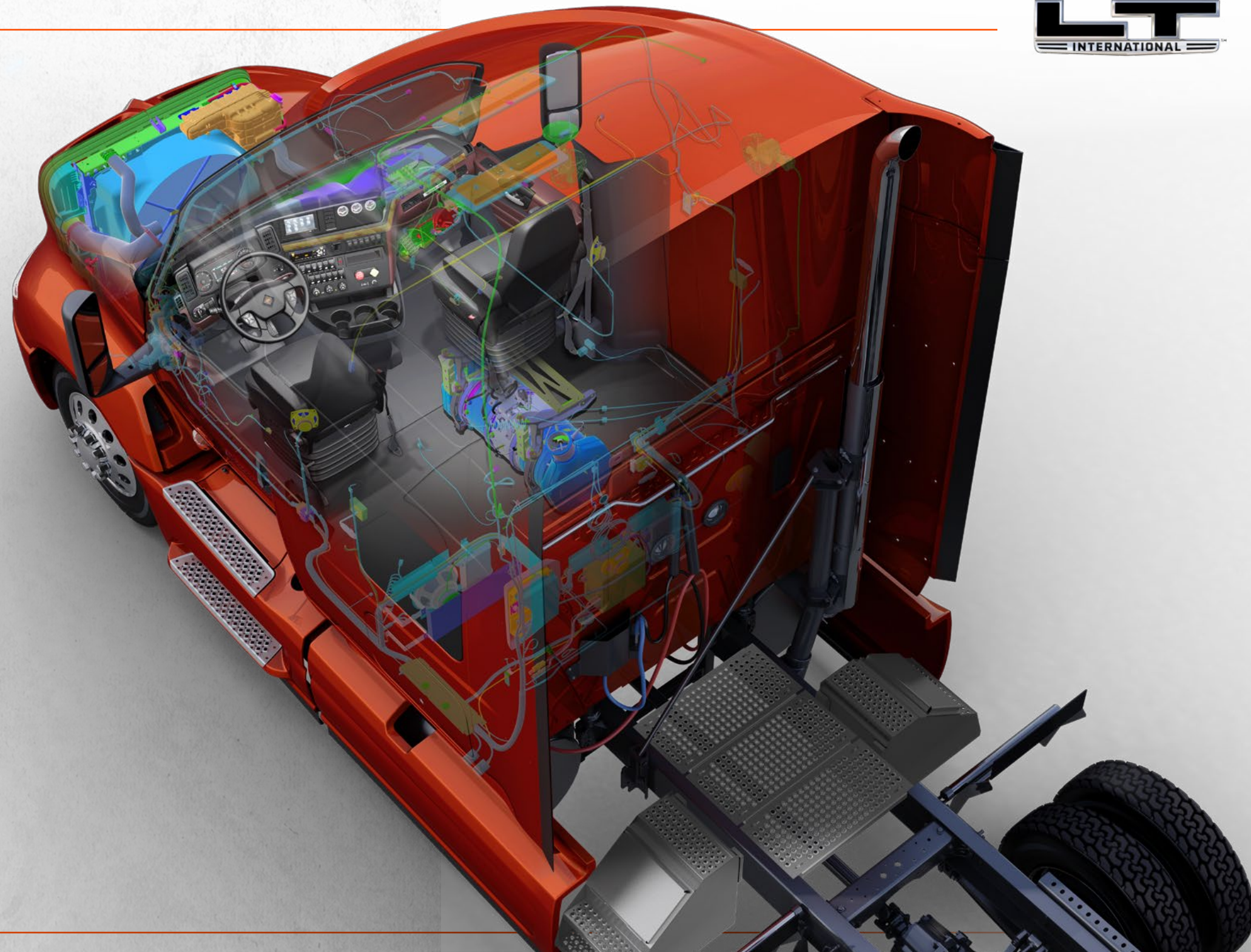



SIMPLIFYING MAINTENANCE TO MAXIMIZE UPTIME.



The faster your truck can be serviced, the faster you're back on the road, meeting delivery schedules and boosting your profitability. The LT Series is designed and engineered to optimize uptime with industry-leading serviceability. All key service points under the hood, inside the cab and around the vehicle are ergonomically designed for easy access and servicing. Many components are engineered with longer intervals between required maintenance. And when you do need service, you can count on expert technicians and an extensive parts inventory from your International dealer.

▶ The LT Series hood opens wide and features gas strut control and torsion bar lift assist. The torsion bar reduces opening effort and enables the hood to be lifted with one hand. The gas strut helps dampen closing to prevent the hood from closing too quickly.

▶ The new, easily removable front grille and 3-piece bumper provide quick access to front components.

▶ Lamp bulbs for turn signals and side markers are easy to access and can be replaced without tools.

▶ Key components offer best-in-class accessibility, including cooling system thermostats, hoses, valves and switches.

▶ Translucent containers allow you to check fluid levels at a glance.

▶ Tethered caps on most fluid containers prevent dropped or lost caps while refreshing fluids.



The industry's largest dealer network of over 700 locations throughout North America, many with Saturday and Sunday availability, helps assure we're there where and when you need us. Count on the expertise of 7,687 highly trained technicians operating out of 7,445 service bays. See how International dealers have earned their reputation for unrivaled customer service.

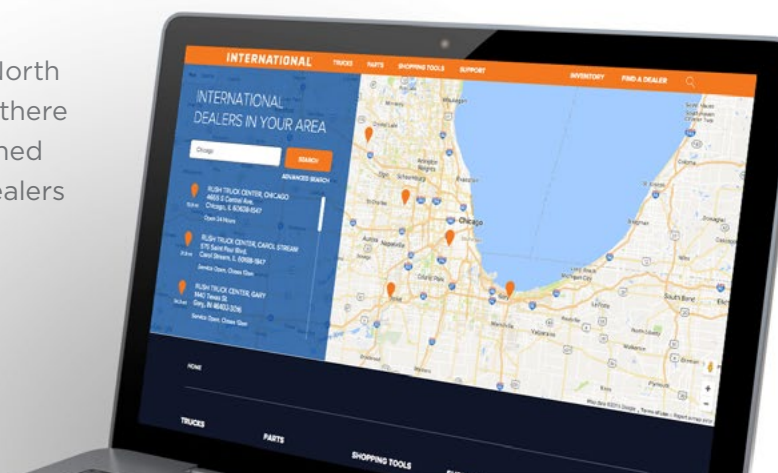



THE LT™ SERIES DELIVERS UP TO A 9% IMPROVEMENT IN FUEL EFFICIENCY.*

With the LT Series, we wouldn't stop until we delivered the most fuel-efficient on-highway truck we've ever built. We spent hundreds of hours in the design studio and through an industry-best testing and development process, finessing every inch of the exterior to improve aerodynamic flow and optimize fuel efficiency. We trimmed weight without compromising quality. We also added a choice of advanced, fuel-efficient powertrains, new state-of-the-art electronic controls systems and more technological advances designed to optimize every drop of fuel.

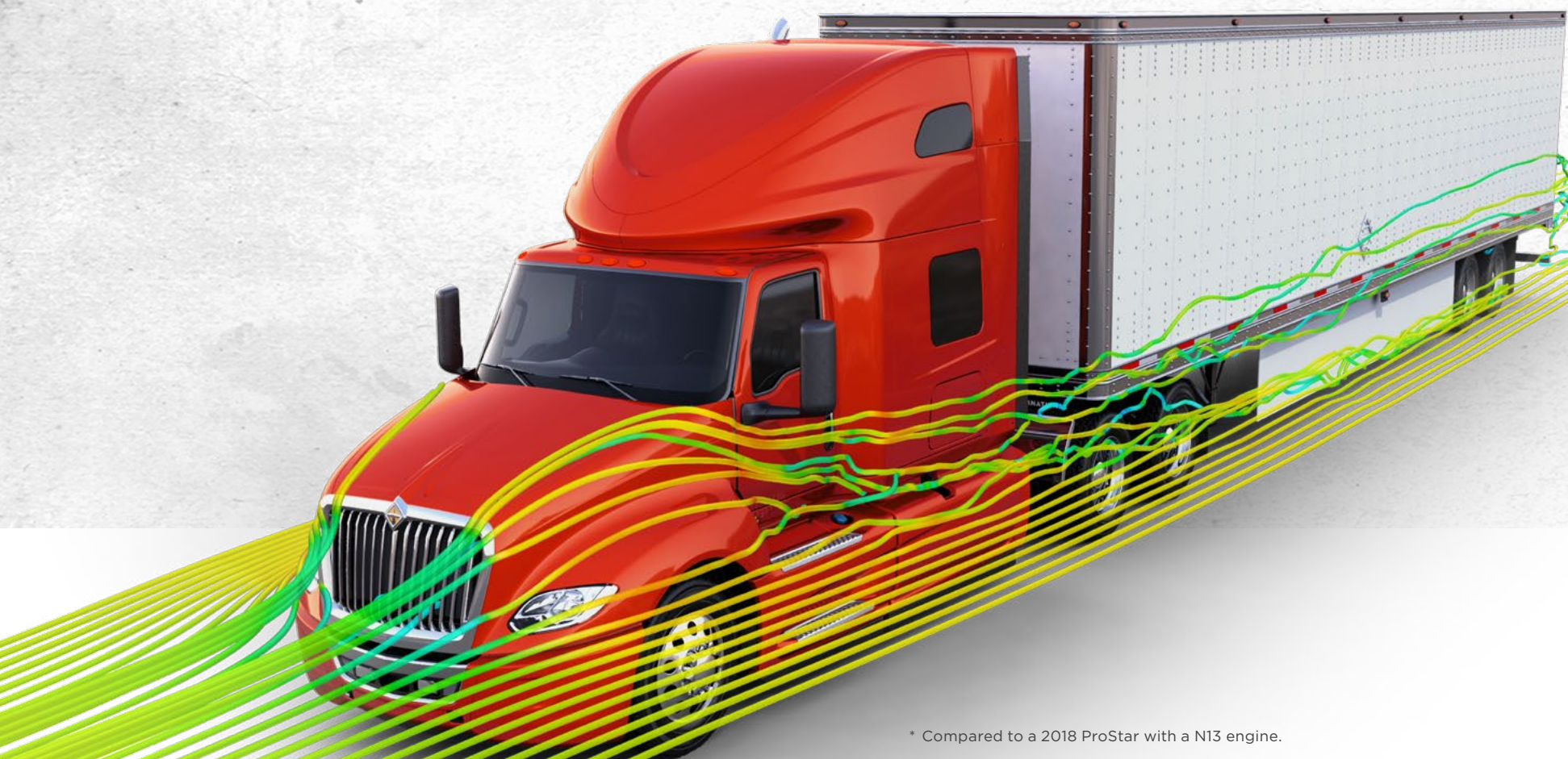

EXTENSIVE AERODYNAMIC IMPROVEMENTS OPTIMIZE AIRFLOW AND REDUCE DRAG BOTH AROUND AND THROUGH THE LT SERIES

- ▶ Pedestal mirrors reduce drag and wind noise
- ▶ The hood top and shoulder are redesigned to enhance air flow
- ▶ New longer 125" BBC hood better directs and smooths out airflow around the cab
- ▶ All-new fender shape optimizes airflow
- ▶ 22" cab extenders close the gap between cab and trailer to limit air turbulence
- ▶ An aero-enhanced 3-piece bumper and front wheel openings are contoured to minimize resistance
- ▶ Chassis skirts have been refined to reduce aerodynamic drag
- ▶ The new cooling module is sealed to smooth airflow under the hood
- ▶ The front air dam design reduces drag by efficiently pushing air down, under and around the truck

THE WIND AVERAGED DRAG ADVANTAGE

In the real world, the wind almost always hits the truck at an angle, not head on. The LT Series was designed with this in mind and is a leader in Wind Averaged Drag. The higher the yaw angle, the better the LT Series performs against the competition.

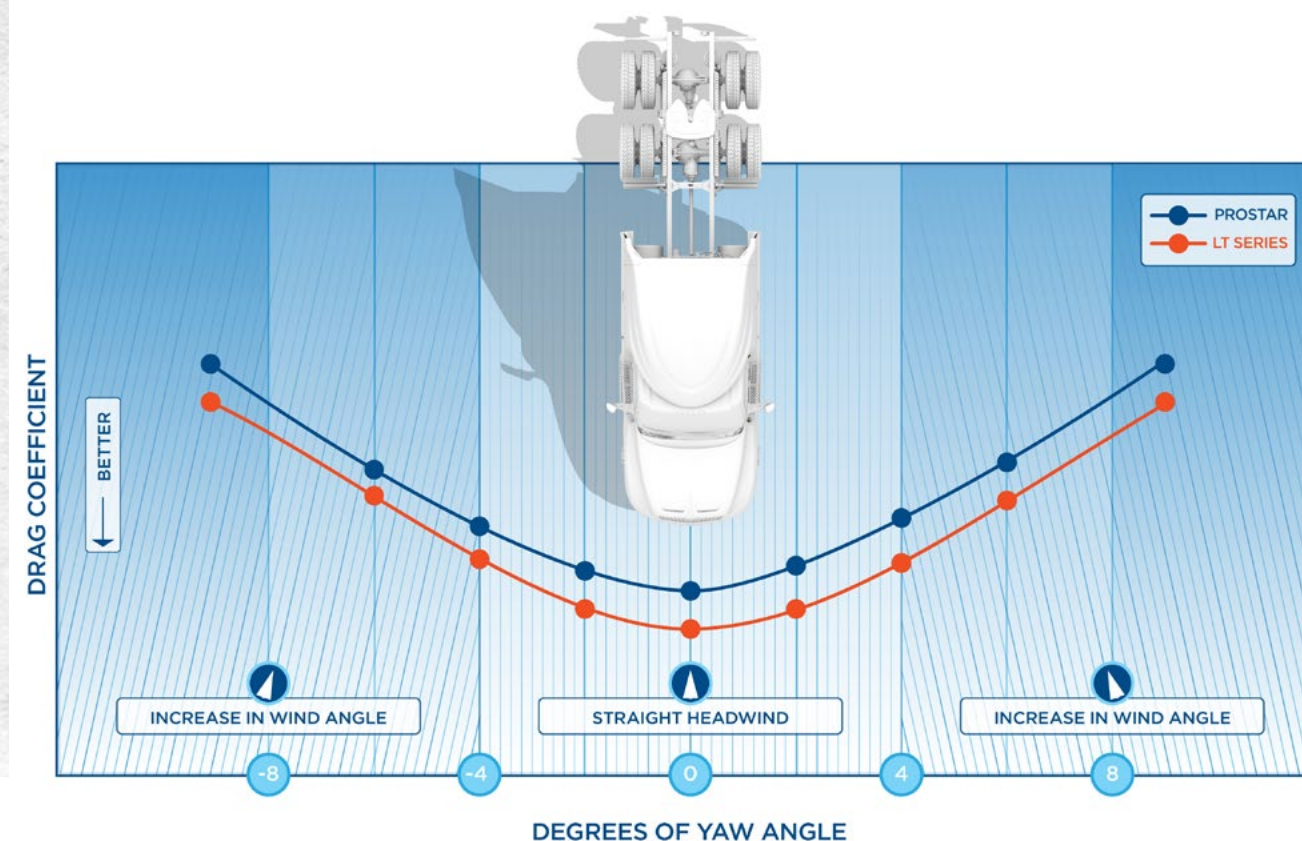

* Compared to a 2018 ProStar with a N13 engine.

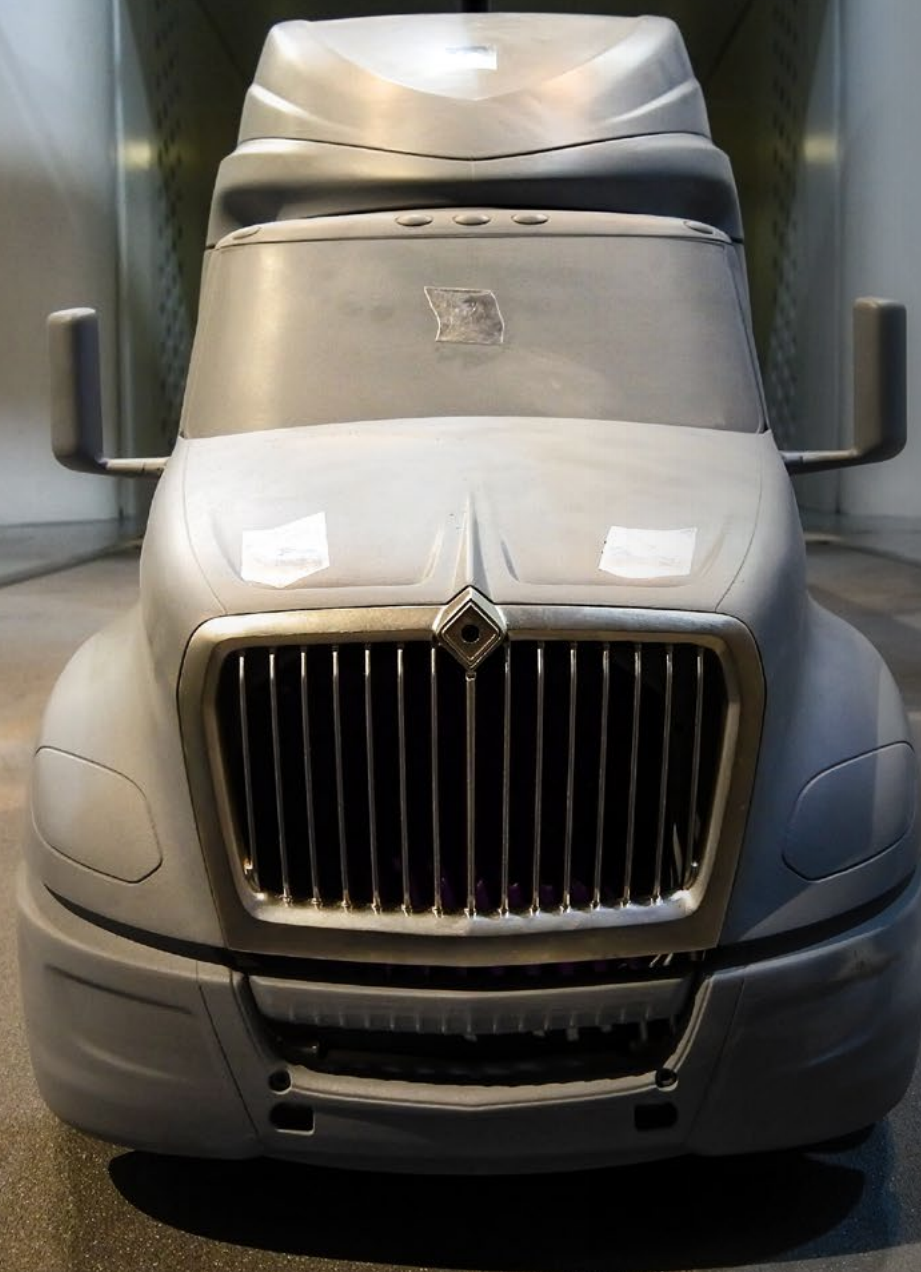

PUTTING EFFICIENCY TO THE TEST.

The LT Series endured an industry-leading testing and retesting process - including wind tunnel testing of scale models, full-size trucks and coast-down testing - to assure every possible efficiency gain. With every 1% of aerodynamic improvement netting a .5% improvement in fuel economy, the LT Series delivers sizable fuel savings that you'll appreciate mile after mile, year after year.



- ▶ Sophisticated new electronic control systems use programmable parameters to optimize efficiency. Predictive cruise control recognizes when the vehicle should accelerate or decelerate before grades to avoid downshifts and minimize braking.
- ▶ A number of measures contribute to a weight reduction of over 400 lbs. vs. the previous model. The suspension and single canister after-treatment system are refined. Mounting hardware for the fuel tank and exhaust system has been streamlined. Everywhere you look, the LT Series is leaner and lighter while optimizing structural integrity.
- ▶ The LT Series uses efficient new lubricants for the drivetrain and axles to reduce parasitic losses from friction.

The LT Series has earned the prestigious U.S. Environmental Protection Agency (EPA) SmartWay® Designation.



The International A26 produces up to a 5% improvement in fuel economy over the engine it replaces due to numerous engineering enhancements that optimize combustion, reduce friction and increase the compression ratio.

The Cummins Eaton SmartAdvantage™ powertrain delivers a 2.2% improvement over the previous powertrain. Error-free, guess-proof shifting assures every driver in your fleet is as efficient as your best driver.

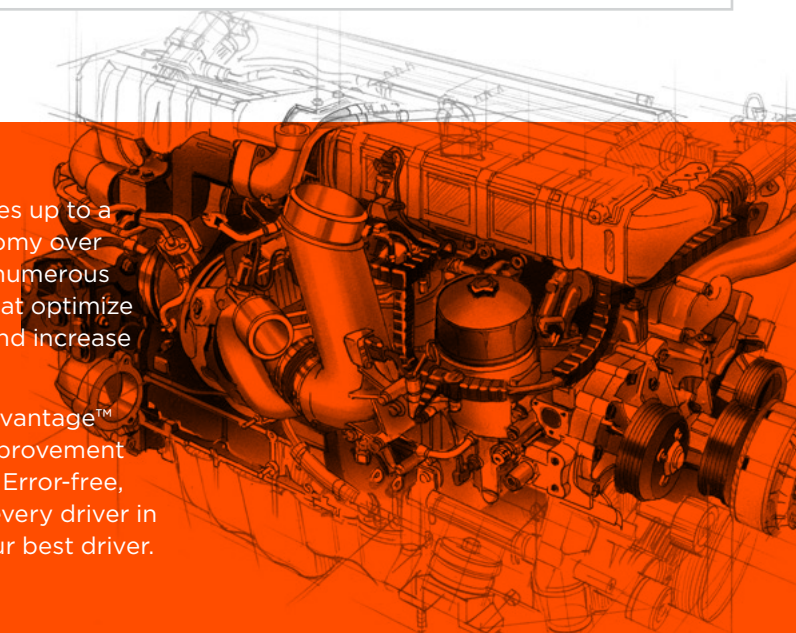



INTERNATIONAL® A26

Designed exclusively for International® Trucks, the 2017 International A26 offers premium performance in an advanced, fuel-efficient 12.4L design. The A26 produces up to 475 HP and 1750 lb.-ft. of torque from a design with a best-in-class dry weight of 2,299 lbs. and is 600-700 lbs. lighter than traditional big bore engines. It also features North America's first Class 7-8 Compacted Graphite Iron (CGI) crankcase design.

The A26's proven EGR system delivers outstanding reliability and maximum uptime. Combustion optimization, friction reduction, increased compression ratio, an all-new cylinder head, and calibration refinements deliver up to a 5% fuel economy improvement over the 2017 N13.

Horsepower [BHP @ RPM]	370 - 475 @ 1700
Torque [LB-FT @ RPM]	1350 - 1750 @ 1000
Gov. Speed [RPM]	1800

Standard Ratings

Key Features

Variable Geometry Turbocharger - Titanium compressor wheel provides excellent longevity over competitive aluminum compressor wheels. Serviceable electronic actuator increases uptime and reduces service cost.

Jacobs Engine Brake® - Variable Geometry Turbocharger improves engine braking performance by up to 67% for increased braking power particularly at low- to mid-RPMs and higher altitudes.

2500 Bar High Pressure Common Rail Fuel System - Delivers maximum fuel injection pressure (36,300 psi) to reduce emissions and fuel consumption, with multiple injection events for smooth and quiet operation.

Lightweight design - Compacted Graphite Iron crankcase, shot peened aluminum flywheel housing, composite valve covers, and a hollow camshaft deliver a lightweight design, maximizing payload capacity.

Cold starting - Cold starting down to -40°F with available oil heater, coolant heater and cold start system with unaided cold starting down to 10°F for dependable starting in extreme climates or when plug-in heating isn't available.

LIGHTWEIGHT,
QUIET AND
EFFICIENT
POWER

Horsepower [BHP @ RPM]	400 - 450 HP @ 1700
Torque [LB-FT @ RPM]	1550-1750 @ 975, 1550-1700 @ 1000
Gov. Speed [RPM]	1800

Ratings for EN3 Transmission

Engine Type	Diesel, 4-Cycle
Configuration	Inline 6-Cylinder
Displacement	12.4 L (758 cu. in.)
Bore & Stroke	4.96 in. & 6.54 in. (126 mm & 166 mm)
Compression Ratio	18.5:1
Aspiration	Variable Geometry Turbocharger
Combustion System	Direct Injection 2500 bar HPCR
Engine Lubrication	42 Quarts (40 L)
Total Engine Weight (Dry)	2,299 lbs. (1099 kg)
Valves	4 Valves Per Cylinder, Single Overhead Camshaft
B10 Design Life	1,200,000 mi (1,931,000 km)

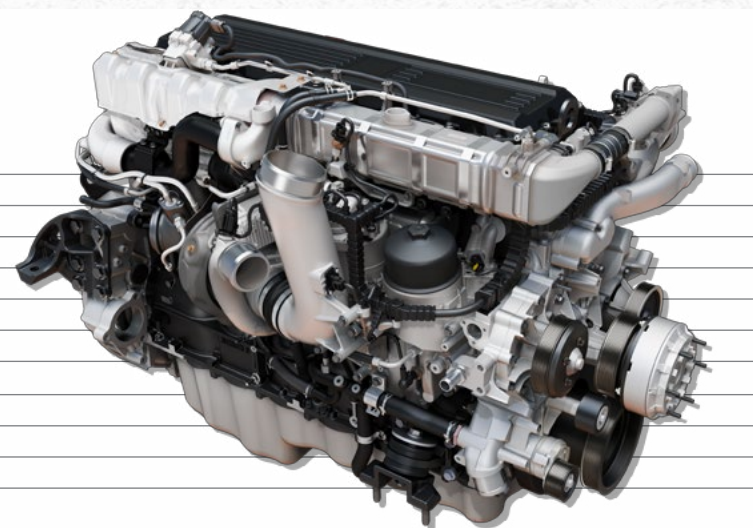

CUMMINS® X15

Legendary Cummins reliability is available in new X15 Performance Series and X15 Efficiency Series configurations. The X15 Efficiency Series produces up to 500 HP with advanced fuel-saving technology that includes dynamic electronic controls with ADEPT features, enhanced engine breathing and an optimized combustion process that leverages Cummins' proprietary VGT™ Turbo and XPI fuel system.

The X15 Performance Series generates up to 565 HP by upgrading virtually every critical component for enhanced air handling, faster throttle response and even stronger braking power at lower RPM.

Horsepower [BHP @ RPM]	400 - 500 @ 1500
Torque [LB-FT @ RPM]	1450 - 1850 @ 1000
Gov. Speed [RPM]	1800

Efficiency Series

Key Features

Variable Geometry Turbocharger - Industry-leading proprietary design is four to six times stronger than previous designs for improved durability. The new design also includes a new impeller for rapid boost and improved braking.

XPI Fuel System - Delivers better performance at wider range of RPMs with multiple injection events to improve efficiency and provide smoother, quieter operation.

Single High-Capacity ECM - Efficient, single ECM management of the engine and after-treatment system for exceptional performance and fuel efficiency.

Cummins After-treatment System - A new flow-through design provides better heat management for improved efficiency and increased ash capacity for fewer cleanings. This integrated system is up to 40% lighter and 60% smaller than some two-part systems.

PROVEN MUSCLE
FOR THE
LONG HAUL

Horsepower [BHP @ RPM]	485 - 565 @ 1600
Torque [LB-FT @ RPM]	1650 - 2050 @ 1150
Gov. Speed [RPM]	2000

Performance Series

Engine Type	Diesel, 4-Cycle
Configuration	Inline 6-Cylinder
Displacement	14.9 L (912 cu. in.)
Bore & Stroke	5.39 in. & 6.65 in. (137mm & 169mm)
Compression Ratio	18.9:1
Aspiration	Variable Geometry Turbocharger
Combustion System	Direct Injection XPI Fuel System
Engine Lubrication	56 Quarts (53 L)
Total Engine Weight (Dry)	3,152 lbs. (1,445 kg)
Valves	4 Valves per Cylinder, Single Overhead Camshaft
B50 Design Life	1,000,000 mi (1,609,000 km)

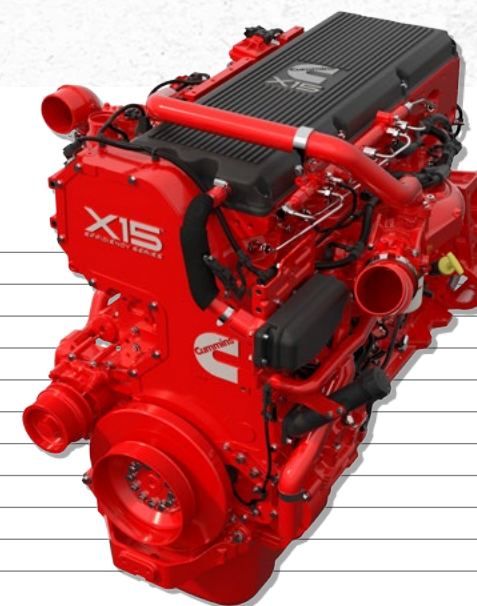



AVAILABLE CONFIGURATIONS.



DAY CAB

125" BBC

Local, Regional, Bulk and Specialized Applications



56" LOW ROOF SLEEPER

125" BBC

Regional Line Haul, Bulk, Flatbed and Specialized Applications



56" HI-RISE SLEEPER

125" BBC

Regional Line Haul and Owner Operator



73" HI-RISE SLEEPER

125" BBC

Long Haul Flatbed, Owner Operator and Specialized Applications



73" SKY-RISE SLEEPER

125" BBC

Long Haul, Owner Operator

LT SERIES SPECIFICATIONS.



Models/BBC/BA

- ▶ 125" BBC / 50" BA

Cab Configurations

- ▶ Day cab
- ▶ 56" Low Roof Sleeper
- ▶ 56" Hi-Rise Sleeper
- ▶ 73" Hi-Rise Sleeper
- ▶ 73" Sky-Rise Sleeper

Axle Configurations

- ▶ 4x2
- ▶ 6x2
- ▶ 6x4

Frames

- ▶ Heat Treated Alloy Steel 120,000 PSI

Engines

- ▶ International A26 12.4L
 - 370 - 475 HP
 - 1,350 - 1,750 lb.-ft.
- ▶ Cummins X15 15L
 - 400 - 565 HP
 - 1,450 - 2,050 lb.-ft.

Transmissions

- ▶ Eaton®: 9, 10, 13, 15, 18-Speed Manual
- ▶ Eaton UltraShift® PLUS: 10, 13, 18-Speed Automated Manual
- ▶ Eaton Fuller Advantage™ Series: 10-speed
- ▶ Eaton UltraShift PLUS LSE 16-speed Transmission
- ▶ Eaton Cummins SmartAdvantage™ Powertrain 10-speed Transmission

Front Axles

- ▶ Hendrickson: 12,000 - 14,000 lbs.
- ▶ Dana Spicer: 12,000 - 14,000 lbs.
- ▶ Meritor: 12,000 - 14,000 lbs.

Front Suspension

- ▶ Spring Monoleaf: 12,000 - 13,200 lbs.
- ▶ Parabolic Taperleaf: 12,000 - 14,000 lbs.

Single Rear Axles

- ▶ Meritor: 23,000 lbs.
- ▶ Dana Spicer: 23,000 lbs.

Tandem Rear Axles

- ▶ Meritor: 40,000 - 46,000 lbs.
- ▶ Dana Spicer: 40,000 - 46,000 lbs.

Rear Suspensions

- ▶ AIR SINGLE
 - International®: 20,000 lbs.
 - International: 23,500 lbs. Vari-rate spring
- ▶ AIR TANDEM
 - International: 40,000 lbs.
 - Hendrickson: HTB 40,000 lbs.
 - Hendrickson: HAS 46,000 lbs.

Brakes

- ▶ Air Drum Brakes with ABS with Optional Automatic Traction Control and Electronic Stability Control
- ▶ Air Disc Brakes with Automatic Traction Control and Electronic Stability Control

Interiors

- ▶ Two Trim Levels:
 - Classic or Diamond
- ▶ Optional Black Cherry Accent Package available with Diamond Level Trim



**TAILOR THE LT SERIES TO SUIT YOUR DRIVER
AND FIT YOUR BUSINESS.**



CAB FEATURES

Cab Trim Panels

Door Trim

Trim Inserts

Instrument Panel

Gauge Cluster

Accent Color

Sun Visors

Lighting

Window Controls

Lock Controls

Cup / Bottle Holders

Overhead Console

USB Accessory Port

CLASSIC

Easy to Clean Soft Touch Vinyl

Neutral

Black

8-gauge, 3.5" Display with Odometer and Trip
Optional: Premium 8-Gauge, 5" Color Display with Virtual Gauges and Integrated Telemetry

Neutral

Two

LED

Manual or Power

Manual or Power

Four

Molded Plastic with Retainer Nets and CB Radio Housing and Paper Towel Storage in Sleeper Configuration

Up to 3

DIAMOND

Easy to Clean Soft Touch Vinyl

Available with Black Cherry Accents - Padded Gray or Black Cherry Soft Touch Panels

Woodgrain - Optional Black Cherry Door Toppers

Black

8-gauge, 3.5" Display with Odometer and Trip
Optional: Premium 8-Gauge, 5" Color Display with Virtual Gauges and Integrated Telemetry

Neutral: Optional: Black Cherry

Two

LED

Power

Power

Four

Molded Plastic with Retainer Nets and CB Radio Housing and Paper Towel Storage in Sleeper Configuration

Up to 3



TRIM LEVEL FEATURES/AVAILABILITY

SLEEPER FEATURES

	CLASSIC	DIAMOND
12 Volt Power Supply	Standard	Standard
Trim Panels	Easy to Clean Soft Vinyl Neutral Trim Panels	Easy to Clean Soft Vinyl Trim Neutral or Available Black Cherry Accents with Woodgrain Inserts
Headliner	Soft Vinyl	Soft Vinyl
Sleeper Windows	Standard	Standard
Windshield Curtain	Optional	Optional
Sleeper Control Panel	Standard	Standard
Microwave Accommodation	Optional	Optional
TV Accommodation	Optional	Optional

56" Low Roof Sleeper Features

Overhead Storage	Two Airline Style Cabinets standard, with an Option for Two Additional	Two Airline Style Cabinets Standard, with an Option for Two Additional
------------------	--	--

56" Hi-Rise Sleeper Features

Overhead Storage	Two or Four Compartments with Netting	Two Compartments with Netting or Doors
Rear Wall Storage	Optional	Optional

73" Hi-Rise Sleeper Features

Overhead Storage	Optional Two or Four Compartments with Nets or Optional Doors	Optional Two or Four Compartments with Nets or Optional Doors
Rear Wall Storage	Optional	Standard
Driver Side Wardrobe	Standard, Optional Doors	Standard, Optional Doors
Passenger Side Cabinets	Utility Cabinet, Lower Right Wardrobe Tower Cabinet, Dresser Cabinet, Refrigerator Storage With or Without Doors	Utility Cabinet, Lower Right Wardrobe Tower Cabinet, Dresser Cabinet, Refrigerator Storage With or Without Doors

73" Sky-Rise Sleeper Features

Overhead Storage	Two Compartments with Nets	Two Compartments with Nets
Rear Wall and Upper/Lower Storage	Standard	Standard
Driver Side Cabinets	Standard Lower and Upper Storage with Shelves, Nets or Optional Doors	Standard Lower and Upper Storage with Shelves, Nets or Optional Doors
Passenger Side Wardrobe	Standard Cabinet Tower Wardrobe and Optional Door, Shelves and Net	Standard Cabinet Tower Wardrobe and Optional Door, Shelves and Net



ONCOMMAND® CONNECTION. ALL MAKES. ALL MODELS.

CONNECT YOUR ENTIRE FLEET THROUGH A SINGLE PORTAL.

If your fleet includes more than one truck make and model, chances are you're using more than one remote diagnostic system to help monitor and manage the health of your vehicles. That's the genius of OnCommand® Connection. It's the first and only all-makes diagnostic system that enhances your uptime by efficiently and accurately monitoring all the trucks in your fleet in real time.

ONCOMMAND CONNECTION HELPS YOU:

- ▶ Monitor and manage the hundreds of fault codes in all your trucks
- ▶ Connect your fleet with service centers and manufacturers
- ▶ Comply with safety standards by taking action on critical faults
- ▶ Make informed choices to manage your fleet for maximum productivity

ONCOMMAND CONNECTION HAS THE CAPABILITIES TO:

- ▶ Diagnose your entire fleet wherever it may be
- ▶ Get action plans for more than 18,000 engine and vehicle faults
- ▶ Prioritize needed repairs while avoiding unnecessary service visits

OnCommand® Connection

REMOTE DIAGNOSTICS FOR ALL MAKES OF VEHICLES.



Use OnCommand Connection to proactively identify potential problems, control maintenance, lower repair costs and maximize uptime.

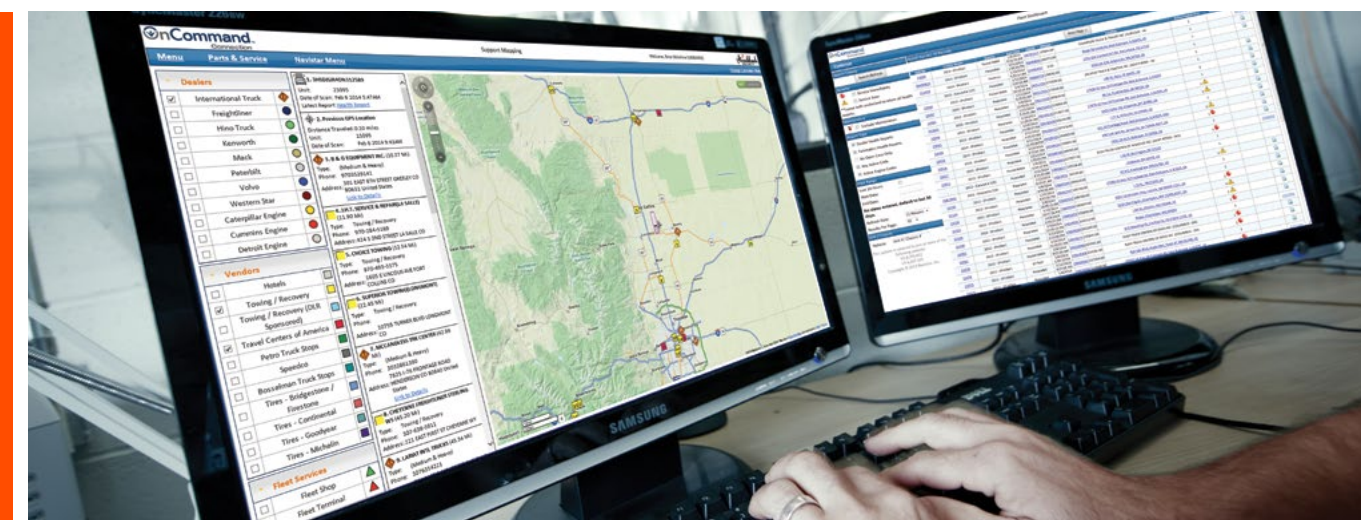

ALL THE TOOLS YOU NEED AT YOUR FINGERTIPS

OnCommand® Connection is designed to keep your vehicles moving and your profits rising through powerful features such as **interactive mapping, engineer-designed action plans and access to your online portal** through your preferred interface – computer, tablet, smartphone or email.



Reduce en route events by proactively scheduling maintenance and repairs



Map tools that plot truck locations, nearest dealers, hotels and local towing providers



Generate real-time comprehensive vehicle health reports



Understand fault codes quickly and easily with descriptions in plain English



Gain more insight with fault code action plans that provide severity information and recommend solutions



NAVISTAR[®]
CAPITAL
 a BMO Financial Group program

Navistar Capital is an industry leader in commercial vehicle financing with over 40 years of experience. We provide customized leases and secured loans with flexible structuring for International heavy and medium duty commercial vehicles. Contact your local International Truck dealer for more information.



FLEETRITE[®]

For more than 40 years, Fleetrite[®] has provided quality parts for all truck and bus makes sold exclusively at your International Truck dealer. Every part is Navistar quality approved and is covered under a 1-year parts and labor warranty. Parts you can trust and affordability you can bank on.



WE HAVE YOUR BACK SO YOU CAN KEEP MOVING FORWARD

Your International dealer is one of the best in the business, and a strong link in the industry's broadest, most capable parts distribution and dealer network.

YES, WE'RE
OPEN

Saturday
488
 Locations

Sunday
47
 Locations

So no matter where you drive, you're not far from one of our

720
 DEALER LOCATIONS

10
 Canadian Provinces

50
 U.S. States

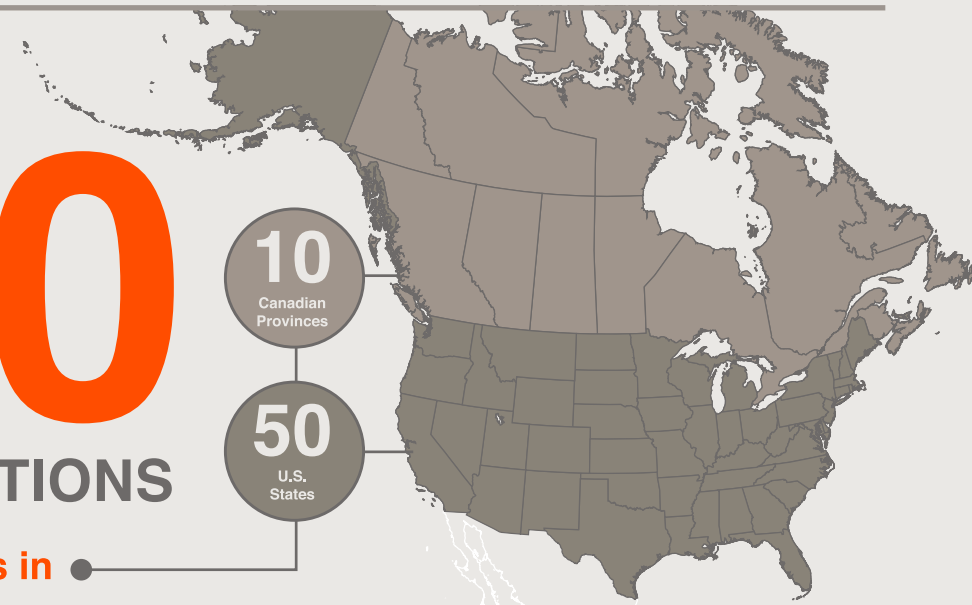

Leading all competitors in

7,687
 TECHNICIANS



7,445
 SERVICE BAYS

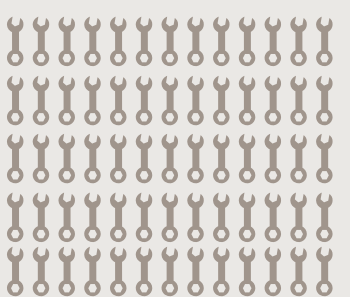



Note: The information and conclusions contained herein are believed to be correct at time of publication, but do not necessarily apply to similar vehicles with different specifications or with production dates after the production of this publication. Vehicles with different specifications or later dates of production may yield different results. Vehicle specifications are subject to change without notice. TAD16013 02/2017 ©2017 NAVISTAR Inc. All rights reserved. All marks are trademarks of their respective owners.