

CONTENTS

PERSONALIZATION

LOCATE A RETAILER

BUILD YOUR OWN

# JAGUAR XE 2018



THE ART OF PERFORMANCE





BY APPOINTMENT TO  
HER MAJESTY THE QUEEN  
MANUFACTURERS OF  
MOTOR VEHICLES  
JAGUAR LAND ROVER LIMITED  
COVENTRY

BY APPOINTMENT TO  
HRH THE DUKE OF EDINBURGH  
MANUFACTURERS OF  
MOTOR VEHICLES  
JAGUAR LAND ROVER LIMITED  
COVENTRY

BY APPOINTMENT TO  
HRH THE PRINCE OF WALES  
MANUFACTURERS OF  
MOTOR VEHICLES  
JAGUAR LAND ROVER LIMITED  
COVENTRY



## THE ART OF PERFORMANCE

Every day we push performance to its limit. Our performance. Our cars' performance. We innovate, we engineer, we design. We master rules and then break them. Only to push further. Past the limits of convention. This is when performance becomes art.

Jaguar. The Art of Performance.





**CONTENTS**

<b>INTRODUCTION</b>		<b>JAGUAR INCONTROL® TECHNOLOGIES</b>	
The Concept of the XE	07	Infotainment and Connectivity	40
The XE - The Facts	08	Touch	43
<b>DESIGN</b>		Touch Pro	45
Exterior Principles	10	Audio	46
Exterior Detail	12	<b>ASSISTANCE AND EFFICIENCY</b>	
Interior	17	Advanced Driver Assistance	48
<b>PERFORMANCE</b>		Efficient Technologies	50
Engines	18	<b>PERSONALIZATION</b>	
Advanced Aerodynamics	22	The XE - Your Choice	52
Lightweight Aluminum Architecture	25	Choose your Engine	54
Chassis and Suspension	26	Choose your Model & Packages	56
<b>DRIVING TECHNOLOGY</b>		Choose your Color	64
Advanced Driving Dynamics	29	Choose your Wheels	66
Added Driver Confidence	30	Choose your Interior	68
Advanced Drivetrain Technology	33	Choose your Accessories	84
Torque Vectoring	35	Technical Specifications	88
Stability and Control	36	Dimensions	90
Head-up Display	39	<b>JAGUAR WORLD</b>	
		Jaguar Experience	92
		The World of Jaguar	94
		Glossary and Legal Information	96



Scan to find out more about the Jaguar XE.

VEHICLE SHOWN: XE R-SPORT IN CAESIUM BLUE WITH OPTIONAL EQUIPMENT





## INTRODUCTION THE CONCEPT OF THE XE

The Jaguar XE is the foundation of the Jaguar sedan car family. A distillation of the design, luxury and technology found in the Jaguar XF and the Jaguar XJ. Inspired by the Jaguar F-TYPE sports car, with its assertive looks and agile drive.

The XE range features an extended engine choice, including the new 2.0 liter 4-cylinder 296HP Turbocharged Ingenium Gas engine. There's also the 2.0 liter 180HP Turbocharged Ingenium Diesel engine, the 247HP Ingenium 4-cylinder engine and the dynamic 3.0 liter 380HP V6 Supercharged Gas engine.

The XE is an exceptional blend of technology, design, and driving dynamics that rewrites all the rules.

VEHICLE SHOWN: XE S IN FIRENZE RED WITH OPTIONAL EQUIPMENT

# THE XE - THE FACTS

The XE brings together the latest Jaguar innovation, technology and design.

### PERFORMANCE AND CHOICE

Find your perfect match in the range of gas and diesel engines offered in the Jaguar XE. Both deliver strong, high-torque performance.

If pure power is your preference, then the XE S with its 380HP V6 Gas engine should satisfy: from a standstill it can reach 60 mph in 4.9 seconds\*7.

### ADDED INTELLIGENCE

Innovative technologies makes driving easier and more enjoyable. The XE offers the options of adaptive Xenon headlights, Traffic Sign Recognition with Adaptive Speed Limiter, Lane Keep Assist with Driver Condition Monitor, Emergency Braking, Adaptive Cruise Control with Queue Assist, Park Assist, and now Blind Spot Assist\*5. And with the optional Powered Gesture Trunk Lid, you can access the trunk when your hands are full. Simply wave your foot under either rear corner and the trunk opens or closes.

### ALWAYS CONNECTED

Part of Jaguar InControl® Technologies, our most advanced infotainment system - InControl Touch Pro™ - is available in the XE. Its next-generation hardware and software enhances every trip through added connectivity, convenience and entertainment. Features include a 10" Touchscreen in the center console, Meridian™ Sound Systems, connected navigation and a new 12" Interactive Driver Display\*1.

### CAPABILITY

The XE offers our unique All Wheel Drive with Intelligent Driveline Dynamics and Adaptive Surface Response. Available with selected engines, these systems are designed to enhance the legendary Jaguar handling, agility and ride, and to give added assistance\*5.

### JAGUAR ELITECARE

Enjoy your Jaguar with peace of mind. The XE is backed by Jaguar EliteCare\*8, our exceptional 5 year / 60,000 mile coverage program including New Vehicle Limited Warranty, Complimentary Scheduled Maintenance, Roadside Assistance and InControl Remote & Protect™.



### LIGHTWEIGHT ALUMINUM ARCHITECTURE

The lightweight architecture of the XE creates a strong body - underpinning power with responsive handling, and refinement with beautiful design.

\*Please see page 96 for further information.

VEHICLE SHOWN: XE S IN FIRENZE RED WITH OPTIONAL EQUIPMENT



## DESIGN EXTERIOR PRINCIPLES

[DYNAMIC PROPORTIONS](#) | [MUSCULAR LOOKS](#)

"It's about paring it down to the bare essentials. Good designers have always said less is more."  
Ian Callum, Jaguar Design Director.

The XE stands out from the competition with the clean surfaces and dynamic looks that form the core of Jaguar design. This is because the Lightweight Aluminum Architecture gave its designers the freedom to work alongside engineers to optimize the car's proportions - The XE is unmistakably a Jaguar. The long, distinctly defined hood is aerodynamically sculpted to channel air over and around the body for greater efficiency. Along with the rising waistline and 'cab rearward' design, it ensures that the XE shares the athleticism of the other cars in the Jaguar range. The XE is crouching, ready to pounce.

VEHICLE SHOWN RIGHT: XE S IN FIRENZE RED WITH OPTIONAL EQUIPMENT



## EXTERIOR DETAIL

### ▶ INNOVATIVE DESIGN

One glance at the XE and you know that it could only be a Jaguar. From the headlights featuring Jaguar signature 'J' blade Daytime Running Lights\*\*, the powerfully sculpted hood, and the chrome side vents, stamped with the Jaguar name, all the way to those distinctive rear haunches. Jaguar, as a world leader in aluminum car construction, has the technology and expertise to create sharper creases from deeper, more innovatively formed pressings. The body side curvature of the XE is aerodynamically honed to sweep air seamlessly rearwards to the tail. The deliberately cropped rear has a short overhang, underscoring the car's performance credentials and enhancing airflow. It culminates with those iconic tail lights that are inspired by the F-TYPE sports car.

\*\*Available with Adaptive Xenon headlights only.  
VEHICLE SHOWN: XE R-SPORT IN CAESIUM BLUE WITH OPTIONAL EQUIPMENT





CONTENTS

PERSONALIZATION

LOCATE A RETAILER

BUILD YOUR OWN



INTRODUCTION

DESIGN

PERFORMANCE

DRIVING TECHNOLOGY

JAGUAR INCONTROL® TECHNOLOGIES

ASSISTANCE AND EFFICIENCY

JAGUAR WORLD







## INTERIOR

**▶ COCKPIT FEEL | EXTENSIVE CHOICE**

Connect with XE the moment you slide into the form-hugging seats - you sit low in a Jaguar. The raised center console adds to the cockpit feel.

Pulsing with a heartbeat, the car creates an emotional connection between driver and machine. Its 72 per minute double beat is similar to a jaguar cat at rest. Press the Start button and XE awakes, the needles sweep, the engine growls. The JaguarDrive Selector™ rises to greet your hand.

The outer air vents are unique in the way that they extend the fascia to nestle in the door casings and give the feeling of width and space. Throughout XE the natural forms of the interior architecture lend themselves to the extensive choice of contemporary or traditional materials and finishes. XE is an inspired place for driver and passengers to be.

INTERIOR SHOWN LEFT AND PREVIOUS PAGE: XE S FEATURING PIMENTO RED LEATHER SPORT SEATS WITH EBONY SUEDECLOTH INSERTS WITH OPTIONAL EQUIPMENT

## PERFORMANCE ENGINES

[INGENIUM ENGINES](#) | 
 [STOP/START TECHNOLOGY](#)

Ingenium technology underpins the diesel engine in the XE range. This low friction, all-aluminum engine has stiff cylinder blocks and twin balancer shafts to ensure inherently low levels of vibration, for smooth day-to-day performance. All engines are equipped with Stop/Start technology and smart regenerative charging - harvesting kinetic energy from braking to charge the battery.



### INGENIUM DIESEL ENGINE

**318 lb.ft. of Torque**

The **Ingenium 2.0 liter 4-cylinder 180HP Turbocharged Diesel** engine offers impressive performance and economy. For an engine of this size it offers high levels of torque and balance, achieved thanks to its variable geometry turbocharger. Adapting to the changing flow of exhaust gases, it maximizes low speed torque for broad power and responsiveness that is uniform, progressive and avoids lag.



### INGENIUM GAS ENGINE

**0-60 mph from 5.2 sec<sup>\*7</sup>**

The **Ingenium 2.0 liter 4-cylinder 296HP Turbocharged Gas** engine's impressive power is balanced with strong fuel economy. For almost instant boost and high efficiency, its low inertia twin-scroll turbocharger features low-friction ball bearings and a high flow compressor wheel. Underpinned by the turbocharger's increased aerodynamic efficiency, the engine delivers rapid acceleration and maximum torque of 295lb-ft between 1,500-4,500rpm.

The **Ingenium 2.0 liter 4-cylinder 247HP Turbocharged Gas** engine delivers outstanding usable power and torque. For excellent acceleration and effortless overtaking, maximum torque is available between 1,200-4,500 rpm. This engine's twin scroll turbocharger is fed by an integrated exhaust manifold that synchronizes exhaust pulses from two separate pairs of cylinders - significantly reducing turbo lag and improving engine response.

\*Please see page 96 for further information.

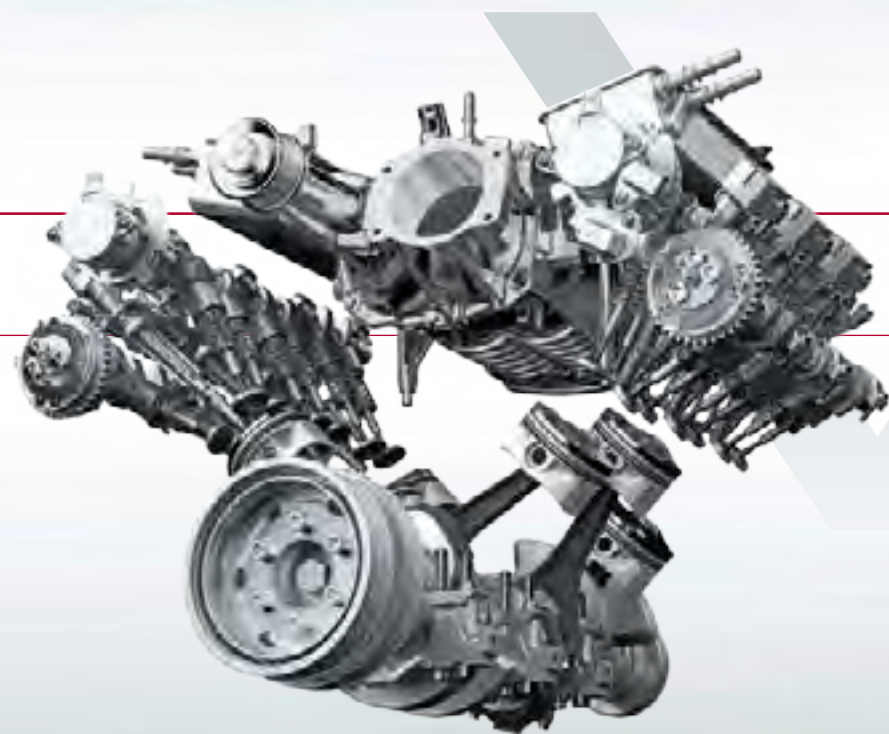

#### SUPERCHARGED GAS ENGINE

## 0-60 mph from 4.9 sec<sup>\*7</sup>

The **3.0 liter V6 380HP Supercharged Gas** engine features a Roots-type twin vortex supercharger that provides linear delivery of power and maximizes responsiveness. This results in performance matching much larger engines, while optimizing economy and reducing emissions. The engine also features dual independent variable cam timing to vary inlet and exhaust valve operation, working alongside lightweight pistons with ultra-low friction piston rings, for increased performance. For added refinement there is a twin, contra-rotating balancer shaft system.

\*Please see page 96 for further information.

VEHICLE SHOWN: XE R-SPORT IN CORRIS GREY WITH OPTIONAL EQUIPMENT



## ADVANCED AERODYNAMICS

### ▶ ADVANCED AERODYNAMICS

The XE form has been rigorously optimized for aerodynamic efficiency and stability. The XE cuts through the air - helping to reduce fuel consumption and lower emissions. Every element exploits the exterior's maximum aerodynamic potential while preserving the stunning proportions of the XE. Vertical apertures in the front bumper's outer edges channel air through vents in the wheel arches and out over the front wheels. Even the race car-inspired underbody protection and diffuser is designed to make the XE as economical and refined as possible.

VEHICLE SHOWN: XE R-SPORT IN CAESIUM BLUE WITH OPTIONAL EQUIPMENT





## LIGHTWEIGHT ALUMINUM ARCHITECTURE

 **BALANCED** | **STRONG AND LIGHTWEIGHT**

Jaguar Land Rover has been at the forefront of aluminum car construction for more than a decade and continues to push the boundaries of this technology. As part of our pioneering recycled aluminum project, REALCAR, we've reclaimed over 50,000 tons of aluminum scrap – the mass of 200,000 XE bodyshells – back into the production process during 2015/16. This has prevented more than the equivalent of 500,000 tons of CO<sub>2</sub> from entering the atmosphere.

The XE is based on our Lightweight Aluminum Architecture, which uses expertise derived from the aerospace industry to deliver premium vehicle characteristics in performance and refinement. This strong bodyshell uses a high strength 6000 series aluminum alloy. Saving weight without compromising durability, it provides very high torsional stiffness, supporting precise handling. It helps achieve optimum weight distribution approaching 50:50.

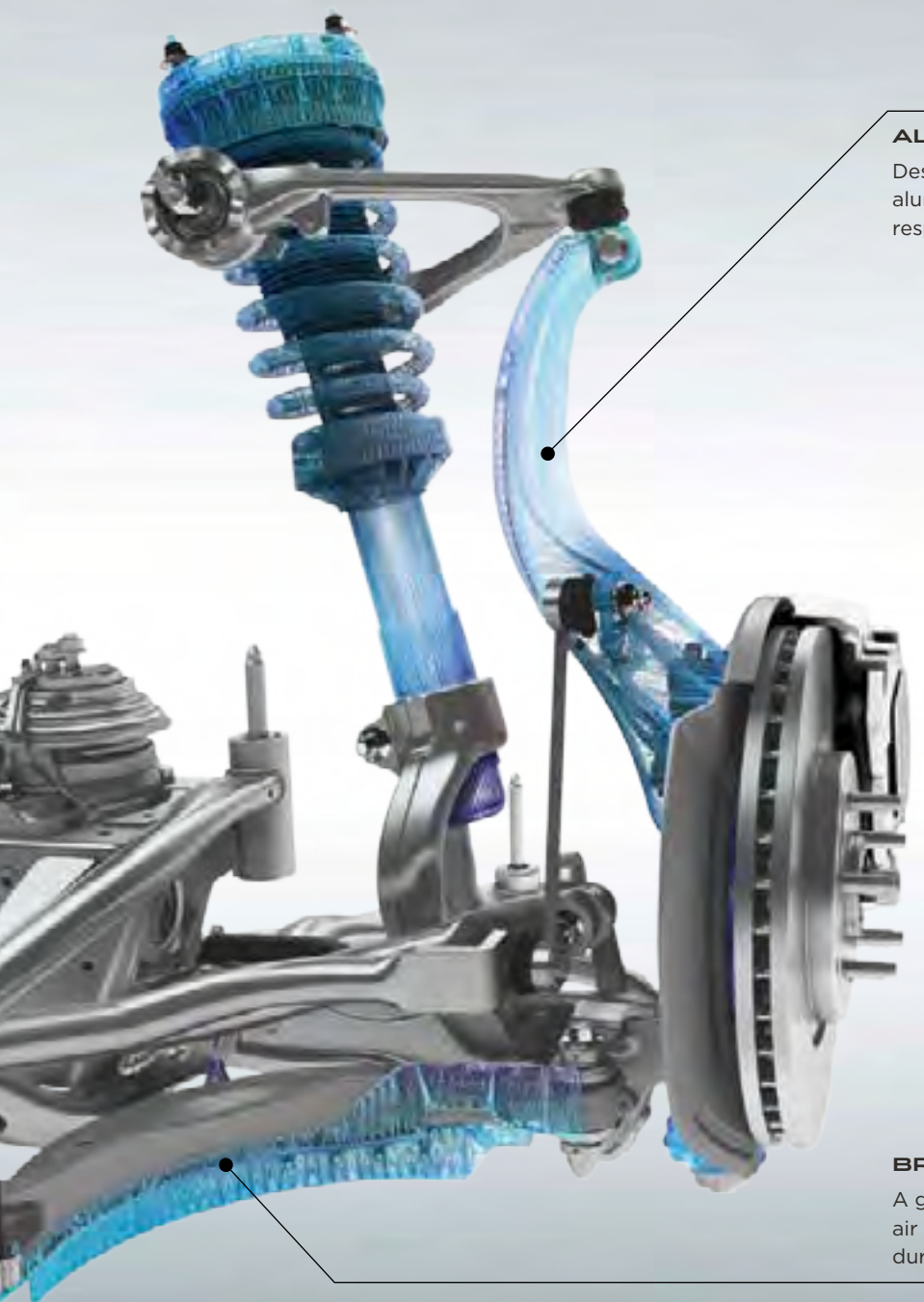

#### ALUMINUM FRONT KNUCKLE

Designed to enhance stiffness and strength, the lightweight aluminum front knuckle helps improve XE agility, responsiveness and refinement for sports-car-like control.

#### BRAKE SCOOP

A glass-filled polypropylene brake scoop channels air onto the brakes for enhanced brake performance during enthusiastic driving.

## CHASSIS AND SUSPENSION

UNIQUE SUSPENSION TECHNOLOGY | COMFORTABLE AND DYNAMIC

The XE responds with agility and performs with dynamism while always maintaining ride comfort - it's a unique balance that makes it a Jaguar. The ideal foundation for these driving dynamics is light, yet strong and stiff, Lightweight Aluminum Architecture with its near 50:50 weight distribution.

The sophisticated front and rear suspension systems complete a chassis that achieves a superb combination of sportiness and refinement. Advanced damper technologies - both passive and adaptive - further improve ride quality and extend the XE breadth of dynamic capabilities. The suspension's control, agility and feedback give the XE the spirit of a sports car.

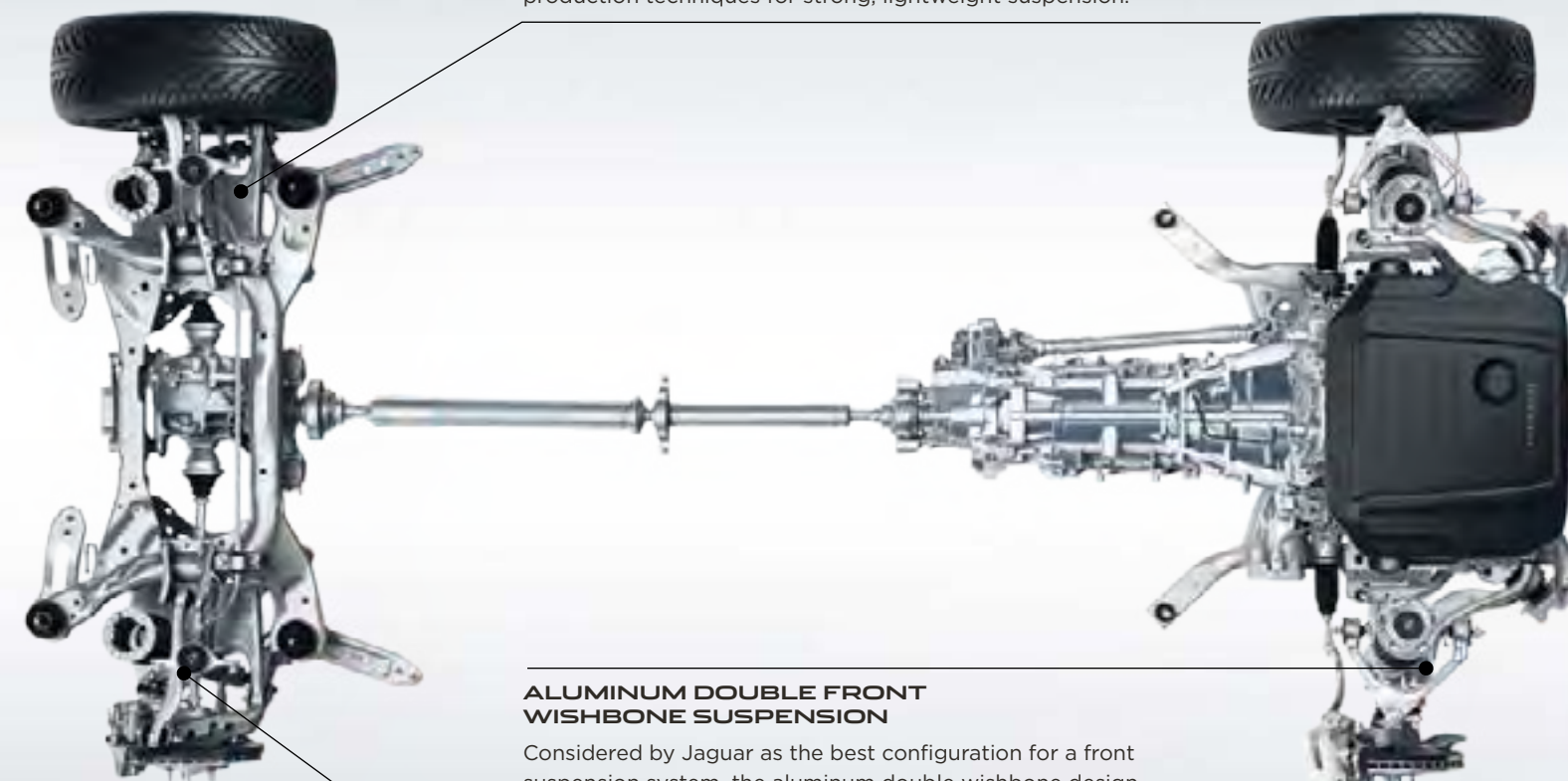

#### INTEGRAL LINK REAR SUSPENSION

Integral Link rear suspension allows the XE to realize a combination of a refined, luxurious ride and sharp, responsive handling. The system, separates and independently manages the lateral, longitudinal and vertical forces acting on the suspension for enhanced control and comfort. Many components are forged or hollow-cast in aluminum - the optimum production techniques for strong, lightweight suspension.

#### ALUMINUM DOUBLE FRONT WISHBONE SUSPENSION

Considered by Jaguar as the best configuration for a front suspension system, the aluminum double wishbone design is modeled closely on the F-TYPE for precise handling and steering response.

#### ADAPTIVE DYNAMICS

The optional Adaptive Dynamics system delivers both precise dynamics and a supple, luxurious ride by monitoring wheel position and body movements. The system constantly monitors conditions and adjusts the dampers to provide the optimum balance between comfort and refinement at all times\*5.

\*Please see page 96 for further information.



## DRIVING TECHNOLOGY ADVANCED DRIVING DYNAMICS

➤ ENHANCE AGILITY | CONTINUOUSLY ADAPTING

Dynamic Mode revises the car's software to further enhance the sporting character. It sharpens the throttle response, increases steering weighting and performs gearshifts more quickly and at higher engine speeds. It also brings visual drama to the driver as the instrument cluster takes on a red glow. Dynamic Mode enhances your connection with the inherent Jaguar performance.

### ELECTRIC POWER ASSISTED STEERING

Electric Power Assisted Steering (EPAS) offers outstanding feedback, control and it is active on demand - saving power for where you really need it. EPAS' sophisticated computer management varies steering assistance as appropriate - increasing assistance for low speed maneuvering and improving feel at higher speeds. It also enables advanced driver assistance features such as Lane Keep Assist and Park Assist\*5.

### ADAPTIVE DYNAMICS\*\*

Whether you're accelerating on the highway, cornering on country roads or navigating around town, optional Adaptive Dynamics modifies the response to match the conditions and your driving style. It analyzes acceleration, cornering, throttle and brake pedal activity, as well as kick-down activation. Steering movement is analyzed up to 500 times a second and body movement up to 100 times a second. Using this information, electronically controlled adaptive dampers then constantly adjust to optimize the suspension settings and maintain the poise and comfort of the XE\*5.

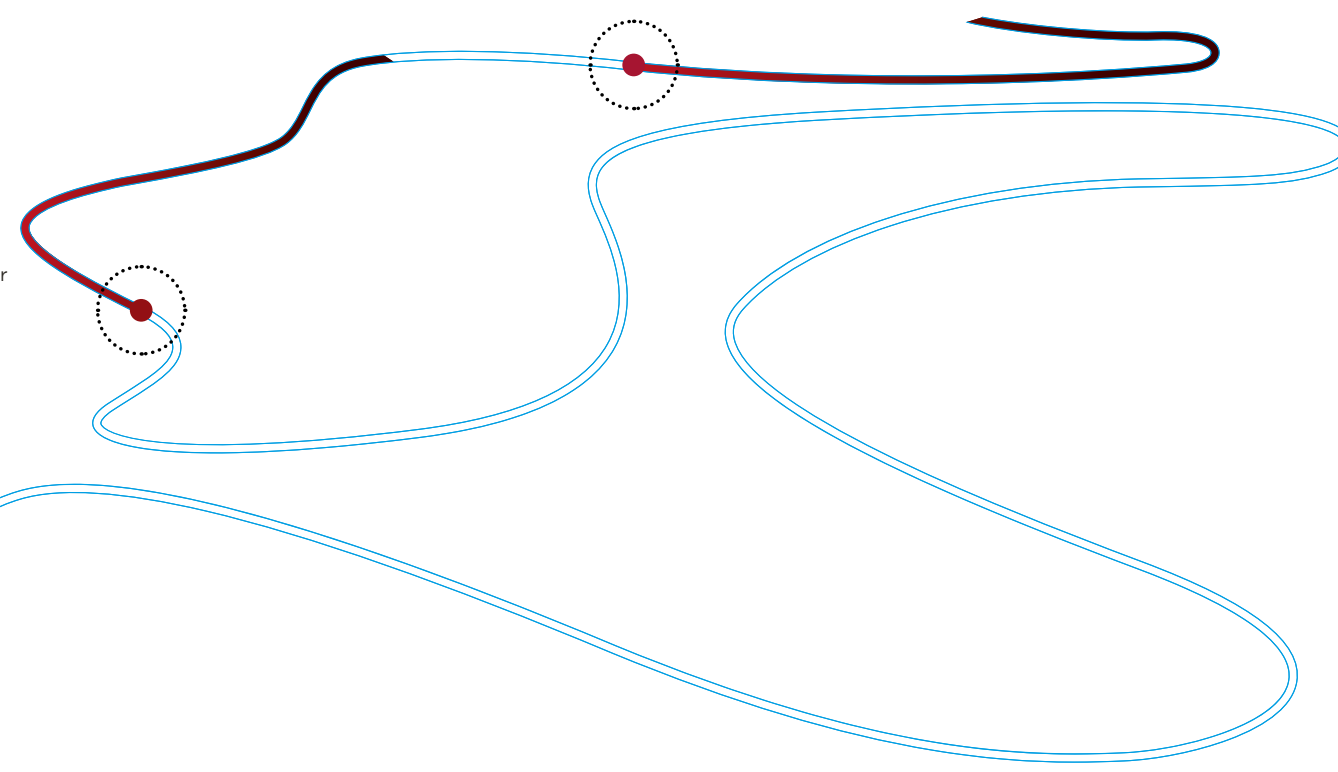

### CONFIGURABLE DYNAMICS\*\*

Bringing technology from the F-TYPE, the optional Configurable Dynamics system allows you to set up the dynamics for throttle mapping, gearbox shift points and steering to suit your performance driving needs. When optional Adaptive Dynamics\*\* is fitted, you can make your setting even more personal by configuring the damper settings.

\*Please see page 96 for further information.  
\*\*Standard on XE S.

## ADDED DRIVER ASSISTANCE

### ▶ ALL SURFACE PROGRESS CONTROL | ADAPTIVE SURFACE RESPONSE

The All Surface Progress Control (ASPC) developed by Jaguar is a low speed cruise control that helps the XE cope with low traction situations. ASPC allows the driver to concentrate more on steering the vehicle. Once activated, you use the cruise control buttons to set a 'target' speed of between 2.2 mph and 18.6 mph. The system then works to achieve and maintain that speed while exerting traction control\*5.

ASPC is standard and gives the XE drivers added assistance over slippery, loose surfaces, undulating terrain and even while descending a difficult incline. It helps make the XE easier to drive in challenging conditions. ASPC also has a pull-away function allowing the XE to progress from rest on low grip surfaces and ascending gradients, as well as a hill descent function that controls vehicle speed on steeper inclines\*5.

On XE S AWD vehicles standard Adaptive Surface Response (AdSR) is designed to recognize differences between surfaces to exploit the maximum available grip. Drawing on Jaguar Land Rover's unrivalled expertise with All Wheel Drive systems, AdSR constantly monitors the car's environment and is designed to adjust the appropriate engine and brake settings. Once selected, AdSR works at all speeds to support you in adverse weather and across challenging surfaces\*5.



MUD/GRAVEL

WET GRASS

SNOW/ICE

WET ROAD

\*Please see page 96 for further information.  
Fitting All Season or Winter tires to the XE can improve capability on slippery surfaces.



## ADVANCED DRIVETRAIN TECHNOLOGY

### ➤ ALL WHEEL DRIVE | INTELLIGENT DRIVELINE DYNAMICS

The XE All Wheel Drive (AWD) system combines the agility and character of Rear Wheel Drive (RWD) with the increased assistance and traction provided by AWD. In normal driving, the XE is predominantly RWD to deliver handling purity, feel and balance. But when roads become more challenging, or when you accelerate more on low-grip surfaces, the system subtly channels power forwards enabling the XE to maintain improved traction for comfortable progress in various conditions\*<sup>5</sup>.

The XE AWD uses a transfer case at the back of the 8-speed Automatic Transmission to manage the appropriate distribution of torque to the front and rear wheels. Engineered to ensure that the XE retains the dynamic behavior of a Jaguar car, the transfer case contains an electro-mechanically activated multi-plate clutch with an actuator to build hydraulic pressure. This pressure is quickly and accurately controlled to generate the required force in the clutch to transfer the optimal amount of torque to the front wheels.

Unlike other systems that react to wheel slip, Jaguar's Intelligent Driveline Dynamics (IDD) software is predictive and uses sensors measuring throttle and steering inputs to anticipate wheel slip. IDD seamlessly co-ordinates these inputs and compares them with responses from the engine, transmission and traction control systems to calculate the traction available and distribute torque accordingly even before grip is lost\*<sup>5</sup>.

The result is a drive which blends the character of RWD with the capability of AWD, providing outstanding levels of performance and control.

#### LOW TRACTION CONDITIONS

On slippery surfaces, such as grass and snow, torque can be balanced between the front and rear wheels to enhance traction.

In extreme conditions where only the front wheels have traction, up to 100 percent of engine torque can be distributed to the front wheels for more optimal grip.

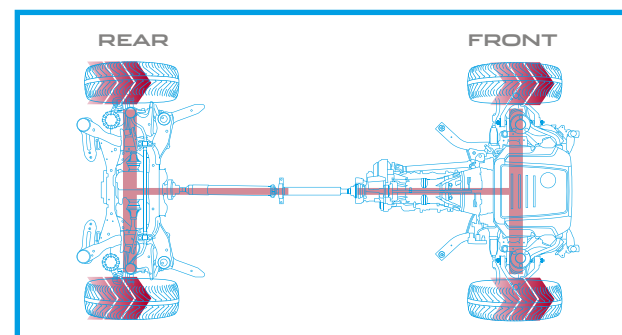

#### DRY ROAD CONDITIONS

In normal conditions, torque is distributed to the rear wheels, delivering acclaimed Jaguar agility and handling.

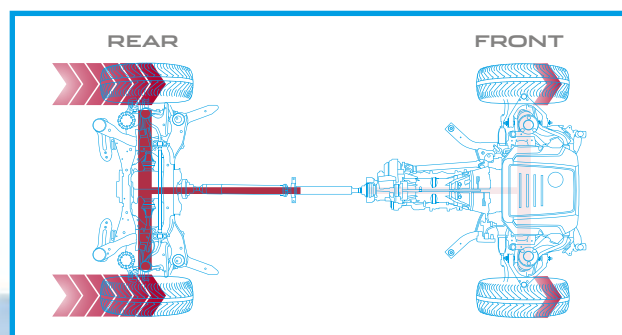

\*Please see page 96 for further information.



TORQUE VECTORING APPLIES BRAKE PRESSURE TO SLOW THE INSIDE FRONT AND INSIDE REAR WHEELS INDEPENDENTLY.

POWER IS SUSTAINED TO MAINTAIN CONSTANT SPEED OF OUTER WHEELS.

ADDITIONAL ROTATIONAL FORCE APPLIED AROUND VEHICLE'S AXIS.

## TORQUE VECTORING

### ➤ ENHANCED CORNERING CAPABILITY

Torque Vectoring improves capability through even the tightest of corners. Torque Vectoring technology provides controlled independent braking on the individual inside front and rear wheels to add to the turning forces acting on the car. In most conditions more braking pressure is applied to the rear inside wheel as this supports the most increased cornering capability, while the front inside wheel is braked for greater effectiveness and refinement. The result is reduced understeer for sharper turning and more consistent road holding. Torque Vectoring delivers increased sports car-like agility and added driver confidence\*5.

\*Please see page 96 for further information.  
VEHICLE SHOWN: XE S IN FIRENZE RED WITH OPTIONAL EQUIPMENT

## STABILITY AND CONTROL

[▶ DYNAMIC STABILITY CONTROL](#) | 
 [ENGINE DRAG TORQUE CONTROL](#)

The stability systems are designed to keep the XE balanced whether you're driving enthusiastically or simply want some reassurance in challenging conditions.

**Dynamic Stability Control (DSC)** monitors the dynamic behavior of the XE, intervening to assist vehicle stability and improving available grip. DSC is designed to reduce engine torque and to apply braking to the appropriate wheels to correct the car's direction of travel by counteracting understeer or oversteer. The XE DSC system has enhanced understeer control to reduce speed and regain control more effectively\*<sup>5</sup>.

**Engine Drag Torque Control (EDC)** mitigates the chance of wheel slip caused by strong engine braking in adverse driving conditions. It acts by briefly increasing torque to the wheels as appropriate\*<sup>5</sup>.

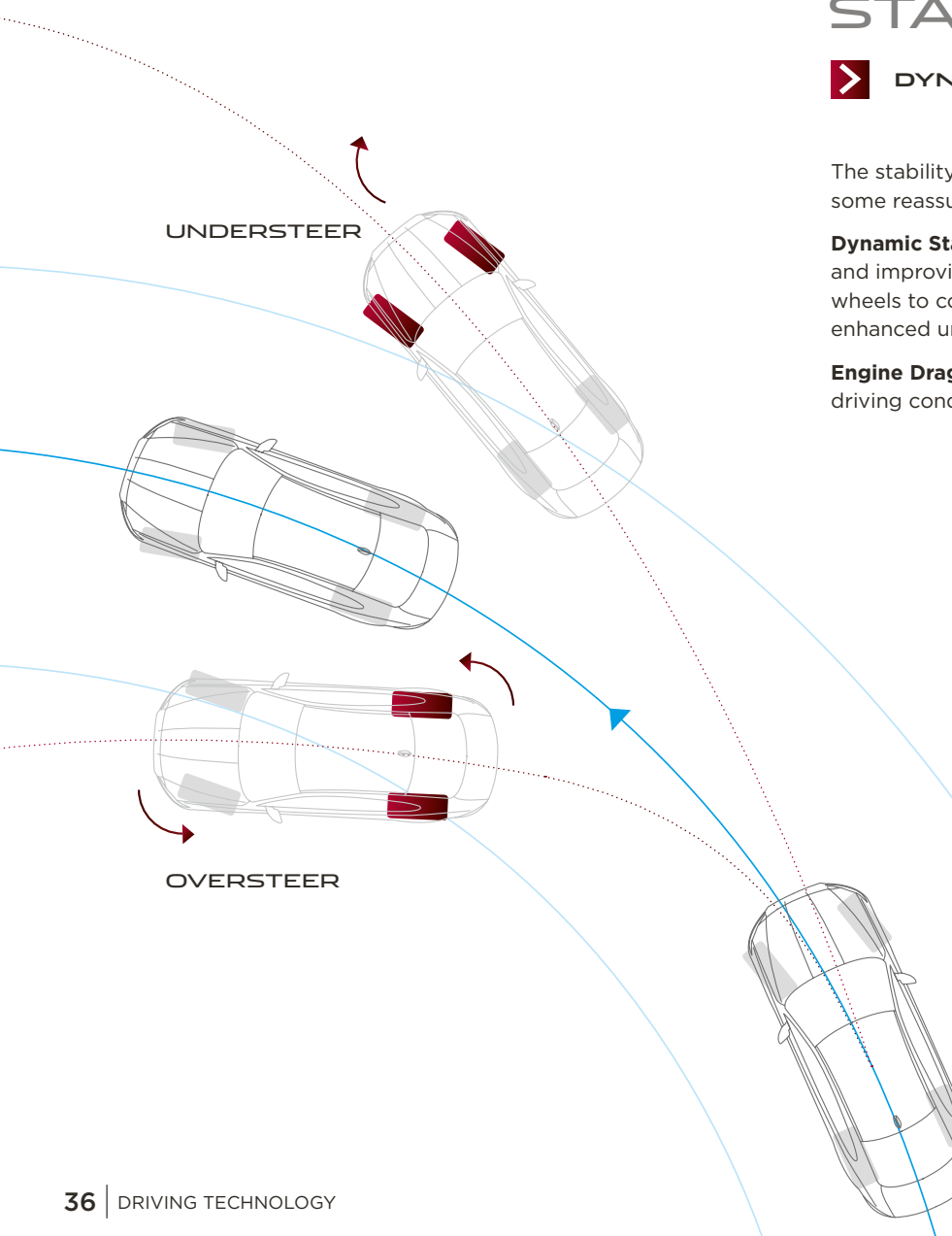

BRAKING APPLIED TO APPROPRIATE WHEELS TO HELP COUNTERACT UNDERSTEER/OVERSTEER

\*Please see page 96 for further information.  
VEHICLE SHOWN: XE S IN FIRENZE RED WITH OPTIONAL EQUIPMENT





## HEAD-UP DISPLAY

### ▶ HEAD-UP DISPLAY WITH LASER TECHNOLOGY

The optional Head-up Display (HUD) with laser technology projects key information onto the windshield. Remaining clear even in direct sunlight, the crisp, bright image can display vehicle speed, navigation, cruise control notifications and Traffic Sign Recognition data, where available. This technology helps you minimize time spent looking down at the instrument cluster and can help you maintain continuous awareness of your speed\*5.

#### ADAPTIVE CRUISE CONTROL

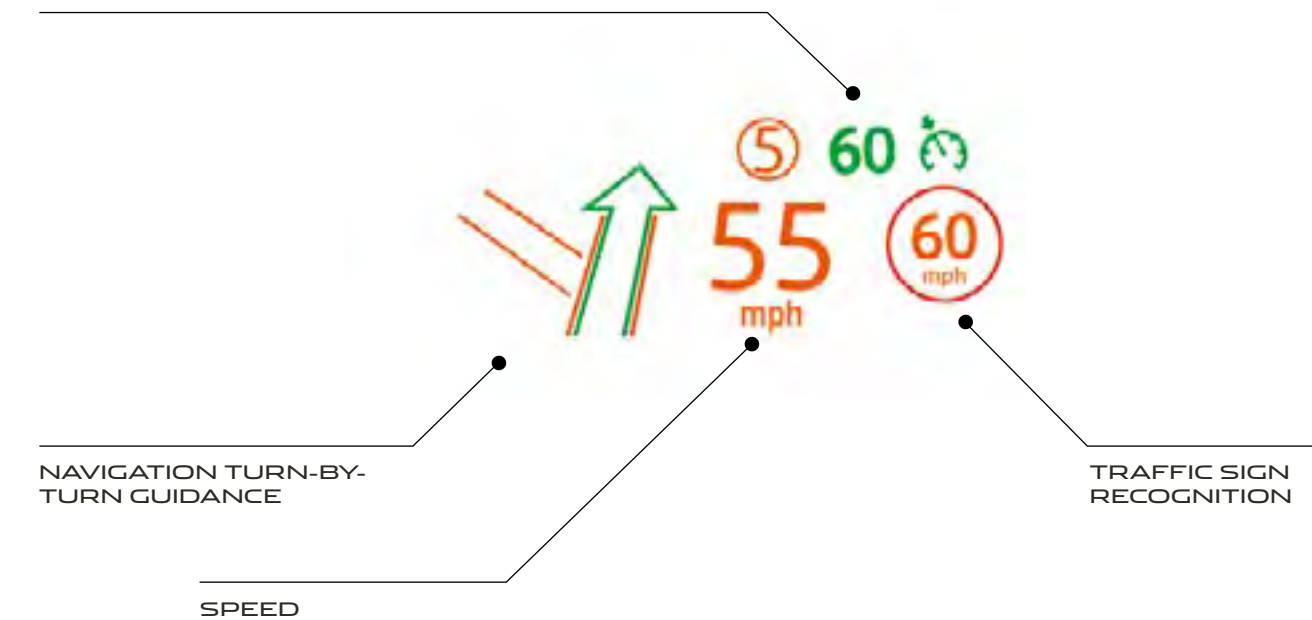

\*Please see page 96 for further information.

## JAGUAR INCONTROL® TECHNOLOGIES INFOTAINMENT AND TECHNOLOGY

➤ TOUCH | TOUCH PRO

Jaguar InControl® is our suite of advanced technologies that links both you and your XE to the wider world. Choose from two Jaguar InControl® infotainment systems: Touch, available as standard, or upgrade to Touch Pro\*1.

\*Please see page 96 for further information.  
 \*\*Not available on Base XE model.  
 \*Optional on XE Prestige model.  
 Third Party programs or applications may require an end user license from the supplier.



### TOUCH\*\*



#### STANDARD ON EVERY XE

- 8" Touchscreen
- 5" Instrument Panel Display with Analog Dials
- Meridian™ Sound System (380W)\*\*
- HD Digital Radio, iPod®, USB, Bluetooth® and AUX connections



**Remote & Protect** consists of SOS Emergency Call, Jaguar Optimized Assistance, Stolen Vehicle Locator and Remote smartphone app

#### OPTIONAL FEATURES

- SD Navigation
- Wi-Fi Hotspot\*3
- SiriusXM® Satellite Radio\*4
- InControl Apps™



### TOUCH PRO\*1



#### AVAILABLE AS AN OPTION

- 10" Touchscreen with multi-touch gestures and customizable homescreen
- 12" Interactive Driver Display with Virtual Dials and full screen 3D Map View
- Navigation Pro
- Meridian™ Surround Sound System (825W)
- HD Radio™, Bluetooth®, and 2 x USB connections
- CD/DVD Drive



**Remote & Protect** consists of SOS Emergency Call, Jaguar Optimized Assistance, Stolen Vehicle Locator and Remote smartphone app

**Connected Navigation** consists of InControl Apps™ and Wi-Fi Hotspot\*3

#### OPTIONAL FEATURES

- SiriusXM® Satellite Radio\*4†

⚙ For information on Touch see pages 42-43.

⚙ For information on Touch Pro see pages 44-45.



8" TOUCHSCREEN SHOWN AT ACTUAL SIZE

<b>Audio</b>	Meridian™ Sound System (380W)**
<b>Display</b>	8" Touchscreen*2
<b>Multimedia*2</b>	HD Digital Radio, iPod®, USB, Bluetooth® and AUX connections
<b>Touch Package</b>	Remote & Protect consists of SOS Emergency Call, Jaguar Optimized Assistance, Stolen Vehicle Locator and Remote smartphone app
<b>Optional Features</b>	InControl Apps™*1, SD Navigation*1, Wi-Fi Hotspot*3 and SiriusXM® Satellite Radio*4

\*Please see page 96 for further information. \*\*Not available on base XE model.

## TOUCH

### ➤ ADVANCED INFOTAINMENT AS STANDARD

The Touch multimedia system is the hub for connectivity, control and entertainment. The key features\*1 are:

**8" Touchscreen** at the heart of the center console. Clear and responsive graphical interface for quick control. Easy to use Touchscreen responds directly to touch and swipe gestures.

**Bluetooth phone connectivity** allows you to link and control your smartphone via Touch either for phone calls or music playback: simple, easy and wire-free.

**Access a world of music** thanks to HD Digital Radio and available SiriusXM® Satellite Radio\*4, as well as iPod, USB and AUX connections.

**Integrated text-to-voice** technology reduces distraction by reading out incoming text messages. You can easily respond with short, prepared messages.

**Precise climate control** is available via the Touchscreen. Adjust temperature levels, direction and intensity of airflow and operate heated or cooled seats (if fitted).

**Remote** is a multi-function app that allows you to monitor as well as interact with your XE from your smartphone. Remote start the engine to pre-condition the climate, lock and unlock the car, locate your XE on a map or by using the beep and flash function, and track your journeys - all via the app.

**Protect** includes SOS Emergency Call and Optimized Jaguar Assistance, which can automatically bring the relevant services to your exact location when needed.

### ➤ OPTIONAL FEATURES

Enhance the capabilities of the Touch multimedia system by selecting from the following options:

**SD Navigation** makes planning journeys and following routes easy, thanks to turn-by-turn voice guidance, intersection views and 3D maps.

**Wi-Fi Hotspot\*3** gives you the option to create a 4G hotspot using the car antenna when you fit a SIM card. This strengthens your link to the outside world, for a more stable connection than an individual device could maintain. Connect up to eight devices to read emails, browse the web and download content.

**InControl Apps™** features a range of Jaguar approved apps that can be connected to the car from your smartphone. It ensures the convenient use of these apps that have been optimized specifically to enhance aspects of your in-car experience\*1.

Explore Jaguar InControl® at [JAGUARUSA.COM](http://JAGUARUSA.COM)

Please consult your local Jaguar Retailer for further details. Certain features require the fitment of a SIM with a suitable data contract.



10" TOUCHSCREEN SHOWN AT ACTUAL SIZE

<b>Audio</b>	Meridian™ Surround Sound System (825W)
<b>Navigation Guidance</b>	Navigation Pro*1
<b>Display</b>	10" Touchscreen*1
<b>Multimedia*2</b>	iPod®, Bluetooth®, HDMI, 2 x USB connections, and CD/DVD Drive
<b>InControl Touch Pro™ Package</b>	<b>Remote &amp; Protect</b> consists of SOS Emergency Call, Jaguar Optimized Assistance, Stolen Vehicle Locator and Remote smartphone app. <b>Connected Navigation</b> consists of InControl Apps™*1, Wi-Fi Hotspot*3. Additional services include Route Planner Companion App, share your destination and ETA, Commute Mode, Arrival Mode, real time traffic information and fuel and parking services.

\*Please see page 96 for further information.



12" Interactive Driver Display with virtual dials

## TOUCH PRO

### ➤ UPGRADE TO NEXT GENERATION INFOTAINMENT

The next-generation hardware and software of Touch Pro advances your vehicle's connectivity and entertainment to the very highest level. Touch Pro features replace or enhance those found in Touch. The key aspects of the Touch Pro system\*1 are:

**Larger, highly-responsive, 10" Touchscreen** at the heart of the center console with customizable homescreen and lightning fast response times. Its interactive side panel makes multi-tasking easy.

**Pinpoint touch control** allows you to manipulate and interact with information swiftly and seamlessly. The Touchscreen responds in the same manner as a smartphone or tablet computer, providing multi-touch gestures such as pinch to zoom and swipe.

**12" Interactive Driver Display with Virtual Dials** and full screen 3D Map View and full screen 3D Map View makes driving even more of a pleasure. It is housed in the instrument display directly in front of the driver. Select full screen 3D Map View or choose one of four graphical themes to suit your personal preference.

**Navigation Pro** with response times that are a fraction of conventional systems'. One of the many innovative features of Navigation Pro is that it allows you to set a destination and the system alerts you if you have insufficient fuel for the journey. It then displays gas stations on the part of the route where you may be low on fuel. The system automatically displays parking options.

### ➤ ENHANCED CONNECTIVITY

The services, technologies and applications found within Connected Navigation provide you with the very best in connectivity and convenience\*1. It offers many features including:

**Route Planner Companion App** offers true door-to-door navigation. Pre-plan your destination and route via your Apple or Android smartphone. The app will guide you to your car, where you will find your selected route available on the car's Touchscreen. When you've completed your road journey, the app can guide you by foot or public transport (where supported) to your destination.

**Share your estimated time of arrival** so your selected contact(s) will know exactly when you will arrive, as calculated by the navigation guidance system. If you're running late, the system can then send automatic updates via text or email, without any further action from you.

**Commute Mode** allows the system to learn your commutes and automatically advises you of the expected journey time based on live and historical traffic movements. The system learns the routes you take for a given destination and then advises which of those is the quickest.

**Arrival Mode** displays interactive 360° street level imagery of your destination for seamless finishes to journeys. It automatically displays again upon your arrival. You can simply tap the Touchscreen to select a nearby parking spot, which appears as an updated destination.

⚙️ Explore Jaguar InControl® at [JAGUARUSA.COM](http://JAGUARUSA.COM)

Please consult your local Jaguar Retailer for further details. Certain features require the fitment of a SIM with a suitable data contract.



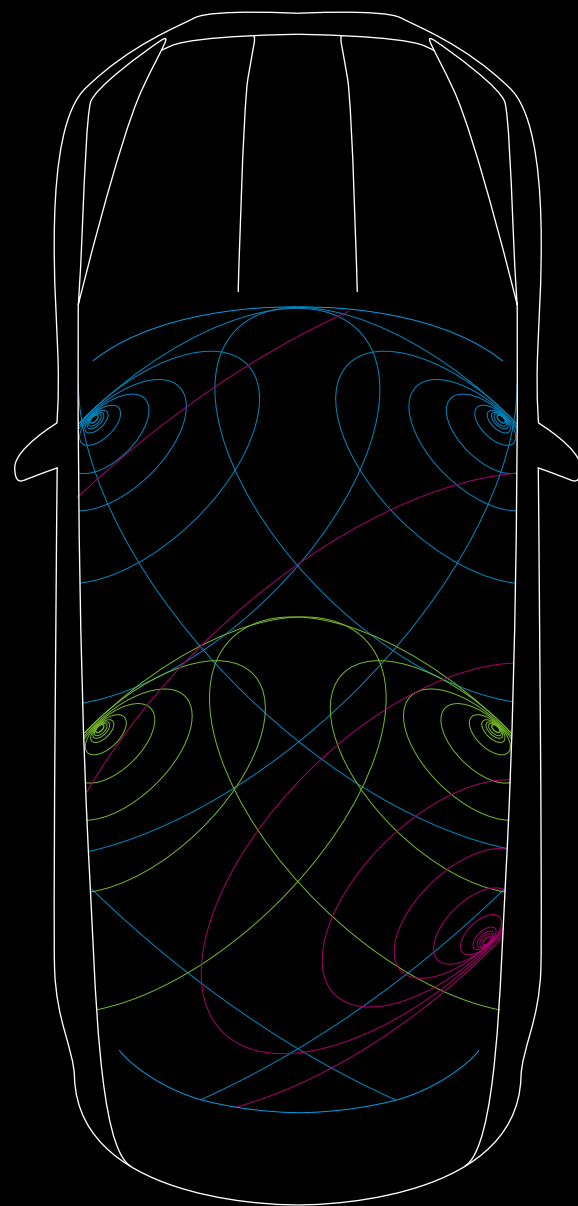

## AUDIO

**JAGUAR SOUND SYSTEM** | 
 **MERIDIAN™ SOUND SYSTEMS**

The superb sound systems bring your music to life. The Jaguar Sound System provides acoustic range through 6 speakers. Offering an enhanced listening experience are the optional Meridian™ Sound Systems. Designed in conjunction with the British audio experts Meridian™, these systems use innovative audio technology and precise speaker placement to give perfectly optimized sound quality. Choose from a range of audio systems, including the 380W Sound System with 11 speakers or the 825W Surround Sound System with 17 speakers. All systems ensure that, wherever you or your passengers sit in your XE, everyone will enjoy a rich, enveloping audio experience.

- Fresh air subwoofer
- Front door waves tweeter midrange bass
- Rear door waves tweeter midrange

Diagram representative of Meridian 380W Sound System.

### SOUND SYSTEMS AVAILABLE IN CONJUNCTION WITH TOUCH



**80**  
WATTS

**6**  
SPEAKERS

**4**  
AMPLIFIER CHANNELS

#### JAGUAR SOUND SYSTEM\*

Speed Dependent Volume\*\*  
80 watts  
6 speakers  
4 amplifier channels



**380**  
WATTS

**11**  
SPEAKERS

**12**  
AMPLIFIER CHANNELS

#### MERIDIAN SOUND SYSTEM\*†

Speed Dependent Volume\*\*  
380 watts  
11 speakers including subwoofer  
12 amplifier channels

### SOUND SYSTEM AVAILABLE IN CONJUNCTION WITH TOUCH PRO



**825**  
WATTS

**17**  
SPEAKERS

**16**  
AMPLIFIER CHANNELS

#### MERIDIAN SURROUND SOUND SYSTEM

DSP amplifier  
Audyssey MultEQ Audio Equalization  
Dynamic Volume Control\*  
825 watts  
17 speakers  
16 amplifier channels

\*\*Automatically adjusts as vehicle speed changes.  
\*Automatically adjusts as vehicle speed changes and/or ambient noise levels change.  
†Standard feature on Premium, Prestige and R-Sport derivatives.

VEHICLE SHOWN: XE PRESTIGE IN YULONG WHITE WITH OPTIONAL EQUIPMENT



## ASSISTANCE AND EFFICIENCY ADVANCED DRIVER ASSISTANCE



**1 EMERGENCY BRAKING\*\***  
Should a potential collision be detected, the XE gives an audible forward collision warning. Visual warnings follow. If the driver takes no action, the system is designed to apply the brakes to help reduce the severity of the possible impact\*<sup>5</sup>, when driving below 50 mph.

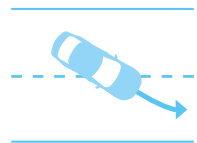

**2 LANE DEPARTURE WARNING\*\***  
Lane Departure Warning (LDW) notifies the driver with a visual alert and a gentle vibration of the steering wheel should the car detect an unintentional drift from its lane\*<sup>5</sup>.

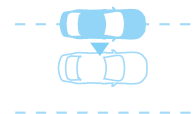

**3 LANE KEEP ASSIST AND DRIVER CONDITION MONITOR\*\***  
Lane Keep Assist (LKA) senses unintentional lane drift and helps steer the XE back into its lane. Driver Condition Monitor (DCM) is designed to detect lapses in concentration due to tiredness by monitoring driver inputs and suggests taking a break via an audible alert and a visual notification in the instrument cluster\*<sup>5</sup>.



**4 TRAFFIC SIGN RECOGNITION AND ADAPTIVE SPEED LIMITER\*\***  
Traffic Sign Recognition technology detects speed limits, including variable limits, and no passing signs via the forward-facing camera, then displays them to the driver. The Adaptive Speed Limiter uses detected traffic sign information to help keep the XE within the appropriate speed limit\*<sup>5</sup>. Where no traffic sign is detected, the Adaptive Speed Limiter can also use the map data from the optional Navigation System.



**5 PARK ASSIST\*\***  
Park Assist makes parking in tight spaces easier than ever. The XE can accurately steer itself during both parallel and perpendicular parking maneuvers - the driver only has to control the brakes and accelerator. An exit-assist function can help guide the XE while leaving a parallel space\*<sup>5</sup>.



**6 BLIND SPOT ASSIST AND REVERSE TRAFFIC DETECTION\*\***  
If your car detects another vehicle in or quickly approaching your blind spot, the Blind Spot Monitor system is designed to alert you via a small warning light in the corresponding exterior mirror. As an enhancement to this, Blind Spot Assist will apply steering torque to guide you away from the vehicle in your blind spot if you begin to change lanes. Using the same radar system, Reverse Traffic Detection is designed to alert you via the Touchscreen of moving vehicles during reversing - for example, when leaving a parking spot with restricted vision\*<sup>5</sup>.

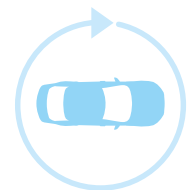

**7 SURROUND CAMERA SYSTEM\*\***  
Helping with various maneuvers, from parking by a curb to getting in and out of tight spaces and intersections, Surround Camera System gives you 360° exterior vision on the Touchscreen. To enhance this system further, new Forward Vehicle Guidance and Forward Traffic Detection are also available. Forming part of the Surround Camera System, Forward Vehicle Guidance provides the driver with an on-screen visualization of the vehicle and parking distance. Forward Traffic Detection helps avoid potential collisions in situations where forward maneuvers involve restricted views\*<sup>5</sup>.

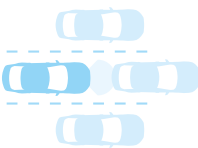

**8 ADAPTIVE CRUISE CONTROL WITH QUEUE ASSIST\*\***  
Adaptive Cruise Control uses radar technology to automatically adjust your speed to maintain a set distance from the vehicle ahead. If that vehicle slows, your XE reduces its speed to maintain a set distance. The XE resumes its pre-set speed as soon as the road in front is clear. Should the car in front stop completely, the Queue Assist function is designed to help bring the XE to a smooth halt. Once the traffic moves, touch the accelerator and the XE will follow the car in front again\*<sup>5</sup>.

\*Please see page 96 for further information.  
\*\*Optional feature.

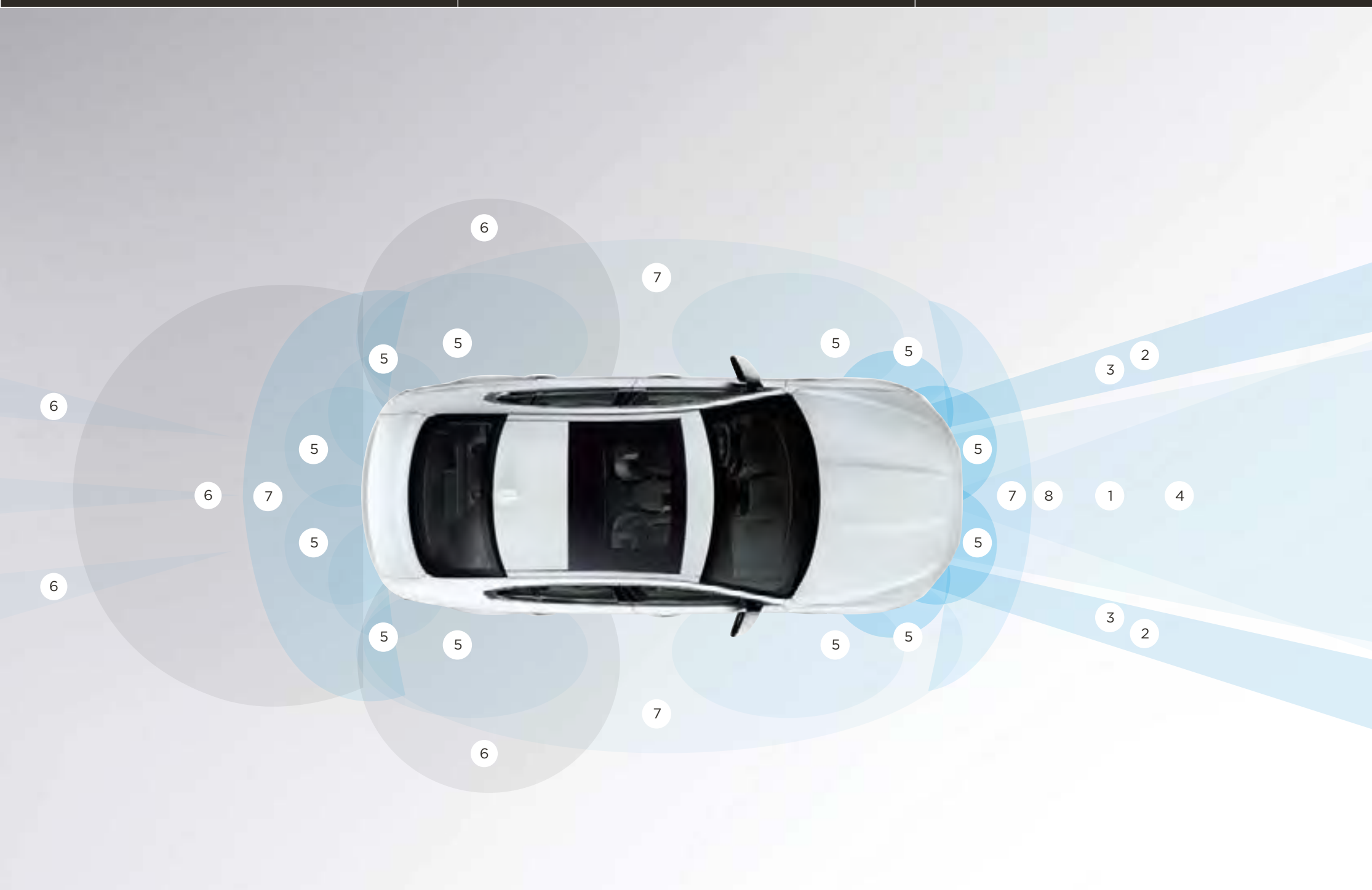

VEHICLE SHOWN: XE PRESTIGE IN YULONG WHITE WITH OPTIONAL EQUIPMENT

## EFFICIENT TECHNOLOGIES

[▶ STOP/START TECHNOLOGY](#) | [CLEAN TECHNOLOGIES](#)

Everyone wants to do more with less. That is why the XE uses a range of technologies to reduce fuel consumption and CO<sub>2</sub> emissions, all while staying true to the dynamic nature of Jaguar.



### STOP/START TECHNOLOGY

The XE engines come with Stop/Start. It shuts down the engine when you come to a complete halt and restarts the engine immediately when required.



### ADVANCED AERODYNAMICS

The aerodynamics are developed and optimized with the aid of Computational Fluid Dynamics analysis. This helps the XE cut through air with ease, meaning less work for the engine.

**AdBlue®**

### ADBLUE®

The diesel models are fitted with AdBlue® to help clean exhaust gases. AdBlue® is a non-toxic, non-flammable, biodegradable additive that cleanses the gases in the car's exhaust system to remove harmful nitrogen oxide emissions.



### LOW FRICTION TECHNOLOGIES

Technologies such as smart coatings on pistons and needle roller bearings in the Ingenium engine range help to reduce friction, particularly at low engine temperatures. This helps the car perform at its efficient best.



# PERSONALIZATION THE XE - YOUR CHOICE

Configure your vehicle at [JAGUARUSA.COM](http://JAGUARUSA.COM)



## CHOOSE YOUR ENGINE

Page 54

Select one of the powerful, gas or diesel engines to suit your driving style.

## CHOOSE YOUR MODEL & PACKAGES

Page 56

Compare the wealth of standard features and options on XE models.

## CHOOSE YOUR COLOR

Page 64

Express your individuality with one of the stunning exterior colors available on the XE.

## CHOOSE YOUR WHEELS

Page 66

Add the personal finishing touch to your new XE, and complement its stunning style, with a set of beautifully designed alloy wheels.

## CHOOSE YOUR INTERIOR

Page 68

There's a wide selection of premium materials, leathers, veneers and finishes for every personal taste.

## CHOOSE YOUR JAGUAR GEAR ACCESSORIES

Page 84

Really make it yours by adding style, practicality and versatility with official XE Accessories from your local Jaguar Retailer.



# 1 CHOOSE YOUR ENGINE

Configure your vehicle at JAGUARUSA.COM

## > DIESEL ENGINE

2.0 LITER 4-CYLINDER TURBOCHARGED	
MAXIMUM POWER	180HP
MAXIMUM TORQUE	318 lb-ft
ACCELERATION 0-60 mph*	
RWD	7.5 seconds
AWD	7.5 seconds*
TOP SPEED	120 mph*
XE, PREMIUM, PRESTIGE, R-SPORT	

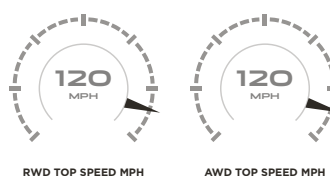
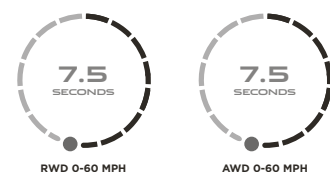

## > GAS ENGINES

2.0 LITER 4-CYLINDER TURBOCHARGED	
MAXIMUM POWER	247HP
MAXIMUM TORQUE	269 lb-ft
ACCELERATION 0-60 mph*	
RWD	6.0 seconds
AWD	5.8 seconds*
TOP SPEED	120 mph*
XE, PREMIUM, PRESTIGE, R-SPORT	

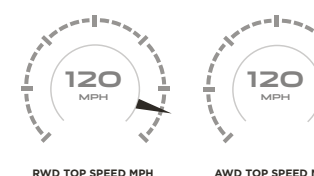

2.0 LITER 4-CYLINDER TURBOCHARGED	
MAXIMUM POWER	296HP
MAXIMUM TORQUE	295 lb-ft
ACCELERATION 0-60 mph*	
RWD	5.4 seconds
AWD	5.2 seconds*
TOP SPEED	120 mph*
PREMIUM, PRESTIGE, PORTFOLIO, R-SPORT	

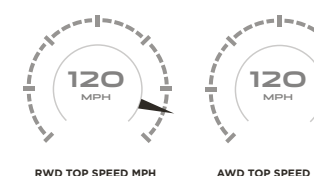

3.0 LITER V6 SUPERCHARGED	
MAXIMUM POWER	380HP
MAXIMUM TORQUE	332 lb-ft
ACCELERATION 0-60 mph*	
RWD	4.9 seconds
AWD	4.9 seconds*
TOP SPEED	121 mph*
S	

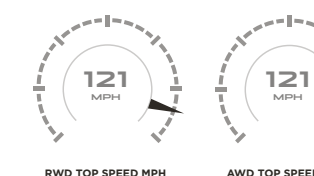

\*Please see page 96 for further information.



# 2 CHOOSE YOUR MODEL & PACKAGES

⚙️ Configure your vehicle at JAGUARUSA.COM

## ➤ LUXURY



### XE

#### KEY FEATURES

- 17" alloy wheels
- Halogen headlights with Daytime Running Lights
- Luxtec seats
- 10-way front seats (8-way electric)
- Gloss Black finisher
- All Surface Progress Control\*5
- Electric tilt and slide glass moonroof
- Jaguar Sound System with 6 speakers
- Chrome window surround with Black waist finisher
- Soft grain leather steering wheel



### PREMIUM

#### KEY FEATURES (IN ADDITION TO XE)

- 18" alloy wheels†
- Rear View Camera\*5
- Meridian™ 380W Sound System
- Memory function with 2 settings for driver's seat and exterior mirrors
- Auto-dimming, power fold, heated door mirrors with memory and approach lights
- HomeLink® System



### PRESTIGE

#### KEY FEATURES (IN ADDITION TO PREMIUM)

- 18" alloy wheels\*\* / 19" alloy wheels†
- Grained leather seats
- Front seats 4-way power lumbar
- Heated front seats
- Bright Chrome window surrounds
- Dark Satin Brushed Aluminum finisher
- Heated soft grain leather sport steering wheel
- SD Navigation System\*2
- Keyless Entry
- Power steering column with memory
- InControl Apps\*1



### PORTFOLIO

#### KEY FEATURES (IN ADDITION TO PRESTIGE)

- 19" alloy wheels
- 18-way electric perforated Windsor leather seats
- Heated and cooled front seats with heated rear seats
- Gloss Figured Ebony veneer
- InControl Touch Pro Navigation\*1
- 12" Interactive Driver Display
- Meridian™ Surround Sound System
- Configurable Ambient Interior Lighting
- Pro Services and Wi-Fi Hotspot\*3
- Head-up Display\*5
- Emergency Braking
- Blind Spot Monitor and Reverse Traffic Detection\*5
- Lane Keep Assist and Driver Condition Monitor\*5
- Front and Rear Parking Aid\*5
- Auto High Beam Assist (AHBA)\*5
- Adaptive Xenon headlights with LED signature
- Powered Gesture Trunk lid

## ➤ SPORT



### R-SPORT

#### KEY FEATURES (IN ADDITION TO PRESTIGE)

- Perforated grained leather sports seats
- R-Sport branded soft grain leather steering wheel
- Black radiator grille with Satin Chrome surround
- Etched Aluminum trim finishers
- R-Sport bodykit - R-Sport front bumper, Body-colored extended side sills, Satin Chrome side power vents with R-Sport badge and trunk lid spoiler
- Metal treadplates with R-Sport branding
- Adaptive Xenon headlights with LED signature
- Auto High Beam Assist (AHBA)\*5
- Lane Departure Warning, Lane Keep Assist, Driver Condition Monitor\*5
- Blind Spot Monitor\*5
- Front and Rear Parking Aids\*5
- Emergency Braking\*5



### S

#### KEY FEATURES (IN ADDITION TO R-SPORT)

- 19" 15 spoke 'Style 1015' with Gloss Black Diamond
- Turned finish alloy wheels
- S branded grained leather and suedecloth sports seats
- S branded soft grain leather steering wheel
- Gloss Black radiator grille with Satin Chrome surround
- Meshed Aluminum trim finisher
- S bodykit - S front bumper, S body-colored and Gloss Black extended side sills, S Gloss Black rear valance and trunk lid spoiler
- Red brake calipers
- Metal treadplates with S branding
- Bright Sport pedals
- Adaptive Dynamics\*5

Images feature optional equipment. Please note that standard features may be replaced when selecting alternative trim levels.  
 \*Please see page 96 for further information.  
 \*\*Available on 20d and 25t derivatives only.  
 †Available on 30t derivative only.



## 2 CHOOSE YOUR MODEL & PACKAGES

Configure your vehicle at JAGUARUSA.COM

KEY STANDARD & OPTIONAL FEATURES	XE	PREMIUM	PRESTIGE	PORTFOLIO	R-SPORT	S
<b>TRANSMISSION, STEERING &amp; DYNAMIC FEATURES</b>						
8-speed Automatic Transmission	●	●	●	●	●	●
Power-assisted, speed sensitive, variable ratio, rack and pinion steering	●	●	●	●	●	●
Electric Power-Assisted Steering (EPAS)*5	●	●	●	●	●	●
Torque Vectoring by Braking (TVBB)*5	●	●	●	●	●	●
Hill Launch Assist*5	●	●	●	●	●	●
All Surface Progress Control (ASPC)*5	●	●	●	●	●	●
Steering wheel mounted shift paddles	●	●	●	●	●	●
JaguarDrive Control™	●	●	●	●	●	●
Normal, Eco & Dynamic Modes*5	●	●	●	●	●	●
Rain/Ice/Snow Mode5	●	●	●	●	●	●
JaguarDrive Selector™ rotary gear selector	●	●	●	●	●	●
<b>SUSPENSION</b>						
Four-wheel independent suspension	●	●	●	●	●	●
Double wishbone front suspension architecture	●	●	●	●	●	●
Integral Link rear suspension	●	●	●	●	●	●
Adaptive Dynamics*5	—	—	○	○	○	●
<b>BRAKES &amp; STABILITY CONTROL</b>						
Anti-lock Braking System (ABS)	●	●	●	●	●	●
Brake pad wear indicator	●	●	●	●	●	●
Cornering Brake Control (CBC)*5	●	●	●	●	●	●
Dynamic Stability Control (DSC) with TracDSC mode*5	●	●	●	●	●	●
Electric Parking Brake (EPB) with drive away release*5	●	●	●	●	●	●
Alloy space saver spare wheel	●	●	●	●	●	●
Red brake callipers	—	—	—	—	—	●

● Standard ○ Optional — Not available  
 P1 Cold Climate Package P2 Vision Assist Package P3 Comfort & Convenience Package P4 Driver Assistance Package  
 P5 Black Design Package P6 Technology Package  
 \*Please see page 96 for further information.

### SAFETY & SECURITY

SAFETY & SECURITY	XE	PREMIUM	PRESTIGE	PORTFOLIO	R-SPORT	S
<b>SAFETY</b>						
Passive front head restraints (whiplash reduction system)	●	●	●	●	●	●
Belt-minder system with audio reminder chime and flashing warning light engages if vehicle is moving more than 10 mph and safety belt is not buckled on occupied front or rear seats	●	●	●	●	●	●
Driver and front passenger safety belt pretensioners	●	●	●	●	●	●
ISOFIX child seat tethered-anchorage	●	●	●	●	●	●
Dual-stage front airbags and seat-mounted side airbags*6 for front occupants	●	●	●	●	●	●
Full length side-impact curtain airbags for front and rear*6	●	●	●	●	●	●
Three-point restraints at all seating positions	●	●	●	●	●	●
Tire Pressure Monitoring System (TPMS)	●	●	●	●	●	●
Adaptive Surface Response (AdSR) (AWD only)	—	—	—	—	—	●
<b>SECURITY</b>						
Anti-theft engine immobilizer	●	●	●	●	●	●
Drive away locking	●	●	●	●	●	●
Security system with perimeter alarm	●	●	●	●	●	●
Emergency phosphorescent release in trunk	●	●	●	●	●	●
<b>LOCKING</b>						
2-stage unlock (programmable)	●	●	●	●	●	●
Central locking with drive-away door locking (programmable)	●	●	●	●	●	●
Jaguar Smart Key System™ with emergency key - provide remote locking/unlocking, access to trunk and activate panic alarm	●	●	●	●	●	●
Keyless Entry	—	—	●	●	●	●
Power operated child locks	●	●	●	●	●	●
Valet function for Touchscreen and trunk security	●	●	●	●	●	●

### DRIVERS AIDS\*5

DRIVERS AIDS*5	XE	PREMIUM	PRESTIGE	PORTFOLIO	R-SPORT	S
Cruise control	●	●	●	●	●	●
Adaptive Speed Limiter (ASL)	●	●	●	●	●	●
Blind Spot Monitor with Closing Vehicle Sensing and Reverse Traffic Detection	—	P2	P2	●	●	●
Blind Spot Assist	—	—	—	P4	P4	P4
Rear View Camera with guidance lines on display	○	●	●	●	●	●
Rear Parking Aid sensors with Touchscreen visual indicators	—	P2	P2	●	●	●
Front Parking Aid sensors with Touchscreen visual indicators	—	P2	P2	●	●	●
Surround Camera System - 4 cameras for front, side and rear views with images shown on the Touchscreen	—	—	—	P4	P4	P4
Park Assist - Parallel & Perpendicular Parking plus Parking Exit	—	—	—	P4	P4	P4
360° Parking Aid - additional sensors to alert the driver to potential side impacts	—	—	—	P4	P4	P4
Traffic Sign Recognition and Adaptive Speed Limiter (ASL)	—	—	—	P4	P4	P4
Adaptive Cruise Control (ACC) with Forward Alert, Queue Assist, Intelligent Emergency Braking and Follow Mode	—	—	—	P4	P4	P4
Emergency Braking (uses forward facing camera)	—	P2	P2	●	●	●
Lane Departure Warning	—	P2	P2	—	—	—
Lane Keep Assist, and Driver Condition Monitor	—	—	—	●	●	●
Head-up Display	—	—	○	●	○	○

### CONVENIENCE FEATURES

CONVENIENCE FEATURES	XE	PREMIUM	PRESTIGE	PORTFOLIO	R-SPORT	S
Approach illumination	●	●	●	●	●	●
Dual function trip computer in Driver Message Center	●	●	●	●	●	●
Outside temperature gauge	●	●	●	●	●	●
Lockable glovebox	●	●	●	●	●	●
HomeLink® System - compatible three-channel garage-door/entry-gate opener	—	●	●	●	●	●
Keyless Push Button Start	●	●	●	●	●	●
Rain sensing, variable intermittent dual wipers	●	●	●	●	●	●
Shopping bag hook in trunk	●	●	●	●	●	●
Powered Gesture Trunk lid (requires Keyless Entry and Rear Parking Aid)	—	—	P3	●	P3	P3
Sunglasses holder in overhead console	●	●	●	●	●	●
Twin front cupholders plus auxiliary power socket in center console	●	●	●	●	●	●
Twin rear cupholders	●	●	●	●	●	●
12V power sockets - located in rear and in trunk	●	●	●	●	●	●



## 2 CHOOSE YOUR MODEL & PACKAGES

Configure your vehicle at [JAGUARUSA.COM](http://JAGUARUSA.COM)

EXTERIOR FEATURES		XE	PREMIUM	PRESTIGE	PORTFOLIO	R-SPORT	S
<b>BODY EXTERIOR APPEARANCE</b>							
Bumpers - Body-colored		●	●	●	●	●	●
Exhaust tips		●	●	●	●	●	●
Front Grille	Grained Black mesh insert with Chrome surround	●	●	●	●	—	—
	Grained Black mesh insert with Satin Chrome surround	—	—	—	—	●	●
	Gloss Black mesh insert with Satin Chrome surround	—	—	—	—	P4	P4
	Gloss Black mesh insert with Chrome surround	—	—	—	—	P4	—
	Gloss Black mesh insert with Gloss Black surround	—	—	P5	—	P5	P5
Window Surround Finishers	Chrome surround with Black waist finisher	●	●	—	—	—	—
	Bright Chrome	—	—	●	—	—	—
	Gloss Black	—	—	P5	—	●	●
Side Power Vents	Bright Chrome	●	●	●	●	—	—
	Gloss Black	—	—	P5	P5	P5	P5
	"R-Sport" Badge	—	—	—	—	●	—
Front Bumper	Satin Chrome	—	—	—	—	—	●
	"R-Sport" Style bumper	—	—	—	—	●	—
	"S" Style bumper	—	—	—	—	—	●
Side Sills	Gloss Black front bumper blades	—	—	—	—	P5	—
	Body-colored	—	—	—	—	●	—
Rear Valance	Gloss Black	—	—	—	—	—	●
	Grained Black	●	●	●	●	●	—
Rear Spoiler - Body-colored, trunk mounted	—	—	—	—	●	●	

● Standard ○ Optional — Not available  
 P1 Cold Climate Package P2 Vision Assist Package P3 Comfort & Convenience Package P4 Driver Assistance Package  
 P5 Black Design Package P6 Technology Package  
 \*Please see page 96 for further information.

EXTERIOR BADGING		XE	PREMIUM	PRESTIGE	PORTFOLIO	R-SPORT	S
<b>EXTERIOR BADGING</b>							
Trunk Left Side - Nameplate		●	●	●	●	●	●
Center Trunk Lid - Jaguar and leaper wordmark		●	●	●	●	●	●
Trunk Right Side	Powertrain	●	●	●	●	●	—
	"AWD" with AWD models only	●	●	●	●	●	●
	"S"	—	—	—	—	—	●
Side Power Vents	Chrome	●	●	●	—	—	—
	Satin Chrome with "R-Sport"	—	—	—	—	●	—
	Satin Chrome	—	—	—	—	—	●
	Side Power Vents - Gloss Black	—	—	P5	—	P5	P5

ELECTRIC GLASS MOONROOF		XE	PREMIUM	PRESTIGE	PORTFOLIO	R-SPORT	S
Electric with tilt/slide one touch operation and electric blind		●	●	●	●	●	●

LIGHTS		XE	PREMIUM	PRESTIGE	PORTFOLIO	R-SPORT	S
<b>LIGHTS</b>							
Halogen headlights with Daytime Running Lights		●	●	●	—	—	—
Adaptive Xenon headlights*5 with LED Daytime Running Lights and variable light distribution including turning lights and auto-leveling		—	P2	P2	●	●	●
LED signature "J" blade Daytime Running Lights		—	P2	P2	●	●	●
Headlight power wash		—	P2	P2	●	●	●
Auto High Beam Assist (AHBA)*5		—	P2	P2	●	●	●
Partial LED tail lights		●	●	●	●	●	●

MIRRORS & WINDOWS		XE	PREMIUM	PRESTIGE	PORTFOLIO	R-SPORT	S
<b>MIRRORS &amp; WINDOWS</b>							
Exterior mirrors - body-colored, electrically adjustable, heated with clear side turn indicators		●	—	—	—	—	—
Exterior mirrors - body-colored, powerfolding, electrically adjustable, heated, auto-dimming with memory, approach lights and clear side turn indicators		—	●	●	●	●	●
Passenger side exterior mirror - dip in reverse		—	●	●	●	●	●
Heated windshield washer jets		P1	P1	○	○	○	○

### INTERIOR FEATURES

CLIMATE CONTROL		XE	PREMIUM	PRESTIGE	PORTFOLIO	R-SPORT	S
Automatic air conditioning with solar sensing, mist sensing, air filtration and dual temperature control for driver and front passenger		●	●	●	●	●	●

DOOR SILL FINISHERS		XE	PREMIUM	PRESTIGE	PORTFOLIO	R-SPORT	S
<b>DOOR SILL FINISHERS</b>							
Non-metal with Jaguar script		●	●	—	—	—	—
Metal with Jaguar script		—	—	●	—	—	—
Illuminated metal treadplates with Jaguar script		—	—	—	●	—	○
Metal with "R-Sport" script		—	—	—	—	●	—
Metal with "S" script		—	—	—	—	—	●

FOOTWELL RUGS		XE	PREMIUM	PRESTIGE	PORTFOLIO	R-SPORT	S
<b>FOOTWELL RUGS</b>							
Front and rear carpet mats		●	●	●	—	●	—
Premium carpet mats		—	—	—	●	—	●
Bright metal pedals		—	—	—	—	○	●

GEAR SELECTOR		XE	PREMIUM	PRESTIGE	PORTFOLIO	R-SPORT	S
JaguarDrive™ rotary gear selector - Bright Chrome finish		●	●	●	●	●	●

INTERIOR LIGHTING		XE	PREMIUM	PRESTIGE	PORTFOLIO	R-SPORT	S
<b>INTERIOR LIGHTING</b>							
Overhead light console with JaguarSense™ control		●	●	●	●	●	●
Phosphor Blue Ambient Interior Lighting		●	●	—	—	—	—
Interior Lighting - Switchgear & ICP lighting, front map lights, trunk illumination and front and rear downlighters		●	●	—	—	—	—
Configurable Ambient Interior Lighting		—	—	—	●	—	—
Driver and front passenger sunvisors with illuminated vanity mirrors		—	—	●	●	●	●
Blue halo illumination on front and rear door signature lines and front and rear door release		—	—	●	—	●	●
Glovebox illumination		—	—	●	●	●	●
Front footwell and rear map lights		—	—	●	●	●	●

MIRRORS & WINDOWS		XE	PREMIUM	PRESTIGE	PORTFOLIO	R-SPORT	S
<b>MIRRORS &amp; WINDOWS</b>							
Auto-dimming interior rear view mirror		●	●	●	●	●	●
Front and rear electric windows with one-touch open/close and anti-trap		●	●	●	●	●	●
Infrared reflective front windshield glass		●	●	●	●	●	●
Heated rear window		●	●	●	●	●	●
Heated front windshield - heated with timer. Includes heated washer jets		P1	P1	○	○	○	○

WINDOW SUNBLINDS		XE	PREMIUM	PRESTIGE	PORTFOLIO	R-SPORT	S
Electric rear window sunblind		—	—	P3	●	P3	P3

SEATING		XE	PREMIUM	PRESTIGE	PORTFOLIO	R-SPORT	S
<b>SEATING</b>							
10x10 way Front seats with 8x8 electric movement - Fore/Aft (2), Cushion Height (2) & Tilt (2), Squab Recline (2) - plus manual Headrest Height (2)		●	●	●	—	●	—
Front seats 4-way power lumbar		—	—	●	●	●	●
14x14 way front seats with 12x12 electric movement - Fore/Aft (2), Cushion Height (2), Cushion Tilt (2), Cushion Extension (2), Squab Recline (2), Bolster (2) & manual Headrest Height (2)		—	—	—	●	—	●
Sport-style front seats		—	—	—	—	●	●
3-stage heated front seats		P1	P1	●	—	●	●
3-stage active ventilated heated and cooled front seats		—	—	P3	●	P3	P3
Driver memory		—	●	●	●	●	●
Fixed rear seat		●	—	—	—	—	—
40:20:40 split fold rear seat		—	●	●	●	●	●
Rear armrest with cupholders		●	●	●	●	●	●
3 rear headrests		●	●	●	●	●	●

STEERING WHEEL & CONTROLS		XE	PREMIUM	PRESTIGE	PORTFOLIO	R-SPORT	S
<b>STEERING WHEEL &amp; CONTROLS</b>							
Soft grain leather steering wheel with Jaguar Sequential Shift™ paddles and remote controls for audio, cruise control & Bluetooth® wireless technology		●	●	—	—	—	—
Soft grain leather sport steering wheel with Jaguar Sequential Shift™ paddles and remote controls for audio, cruise control, Bluetooth® wireless technology and JaguarVoice™		—	—	●	●	●	●
Heated steering wheel		P1	P1	●	●	●	●
"R-Sport" script on steering wheel		—	—	—	—	●	—
"S" script on steering wheel		—	—	—	—	—	●
Power adjustable steering column (reach and rake) with memory		—	—	●	●	●	●
Three flash lane change/turn indicator		●	●	●	●	●	●



## 2 CHOOSE YOUR MODEL & PACKAGES

Configure your vehicle at JAGUARUSA.COM

### INTERIOR FEATURES CONTINUED

	XE	PREMIUM	PRESTIGE	PORTFOLIO	R-SPORT	S
<b>INTERIOR TRIM</b>						
Front center console with storage compartment, auxiliary power socket, 3.5mm stereo auxiliary input socket and armrest	●	●	●	●	●	●
Luxtec seats	●	●	—	—	—	—
Grained leather seats	—	—	●	—	—	—
Perforated grained leather seats	—	—	P3	—	●	○
Perforated Windsor leather seats	—	—	—	●	—	—
Grained leather and suedecloth seats	—	—	—	—	—	●
Luxtec-wrapped instrument panel	—	—	—	●	●	●
Seat back map pocket - Net	—	—	●	●	●	—
Morzine headliner - Oyster	●	●	●	—	—	○
Morzine headliner - Ebony	—	—	—	—	●	●
<b>VENEER TRIM</b>						
Gloss Black	●	●	—	—	—	—
Dark Satin Brushed Aluminum	—	—	●	—	—	—
Etched Aluminum	—	—	—	—	●	—
Satin Burl Ash	—	—	—	—	○	○
Gloss Figured Ebony	—	—	○	●	—	—
Carbon Fiber	—	—	—	—	○	○
Meshed Aluminum	—	—	—	—	—	●

### INFORMATION, COMMUNICATION AND ENTERTAINMENT

	XE	PREMIUM	PRESTIGE	PORTFOLIO	R-SPORT	S
<b>MULTIMEDIA</b>						
Physical dials with 5" full color TFT LCD display	●	●	●	—	●	●
Full TFT / LCD Instrument Cluster	—	—	P6	●	P6	P6
InControl Touch™ 8" capacitive Touchscreen display with controls for audio, climate control, Bluetooth® telephone connectivity and navigation <sup>1</sup>	●	●	●	—	●	●
InControl Touch Pro™ 10" capacitive Touchscreen display with controls for audio, climate control, Bluetooth, telephone connectivity and navigation <sup>1</sup>	—	—	P6	●	P6	P6
ECO HMI - Includes Eco data analysis, parasitic load monitor and Driver Eco	●	●	●	●	●	●
Jaguar 80W Sound System with 6 speakers	●	—	—	—	—	—
Meridian™ 380W Sound System with 11 speakers incl 1 subwoofer	—	●	●	—	●	●
Meridian™ 825W 7.1 Channel Digital Surround Sound System plus Meridian Trifield mode, 17 speakers including 1 subwoofer, separate DSP, Audyssey MultEQ and Meridian Cabin Correction	—	—	P6	●	P6	P6
Dynamic Volume Control	●	●	●	●	●	●
HD Radio™	●	●	●	●	●	●
Front media interface (USB & iPod®)	●	●	●	●	●	●
SiriusXM® Satellite Radio <sup>4</sup>	○	○	○	●	●	●
InControl Apps™ enables use of optimized third party smartphone apps installed on a phone through the vehicle's Touchscreen <sup>1</sup>	○	○	●	●	●	●
Bluetooth® wireless technology for cell phone and audio streaming <sup>2</sup>	●	●	●	●	●	●
<b>NAVIGATION</b>						
Navigation System with SD Card-based mapping <sup>2</sup>	○	○	●	—	●	●
InControl Touch Pro™ - Navigation System with 60GB Solid State Disk (SSD) Drive-based mapping <sup>1</sup> . Includes Pro Services, HDD-based virtual multichanger and single slot in dash CD/DVD player	—	—	P6	●	P6	P6
<b>TELEMATICS</b>						
InControl Protect™ - SOS Emergency Call, Jaguar Assistance Call and Stolen Vehicle Locator. Service complimentary for 5 years	●	●	●	●	●	●
InControl Remote™ - Smartphone app for vehicle status (fuel level, security status, last parked, direction to vehicle), vehicle lock/unlock, air conditioning remote setting through engine start. Feature complimentary for 5 years	●	●	●	●	●	●
InControl Wi-Fi™ - 4G Hotspot - includes 3GB or 3 months (whichever comes first) complimentary data subscription <sup>4</sup>	—	○	○	●	○	○

● Standard ○ Optional — Not available NCO No Cost Option

P1 Cold Climate Package P2 Vision Assist Package P3 Comfort & Convenience Package P4 Driver Assistance Package

P5 Black Design Package P6 Technology Package

<sup>1</sup>Please see page 96 for further information.

### OPTION PACKAGES

	CODE	XE	PREMIUM	PRESTIGE	PORTFOLIO	R-SPORT	S	DESCRIPTION
Cold Climate Package	Z88D	○	○	—	—	—	—	Heated front seats, heated steering wheel, heated front windshield, heated washer jets
Vision Assist Package <sup>5</sup>	Z86A	—	○	○	—	—	—	Adaptive Xenon headlights with LED signature Auto High Beam Assist (AHBA), Headlight power wash, Blind Spot Monitor with Closing Vehicle Sensing, Reverse Traffic Detection, Front and Rear Parking Aids, Lane Departure Warning (LDW), Emergency Braking
Comfort & Convenience Package	Z28C	—	—	○	—	○	○	Cooled front seats, heated rear seats, electric rear window sunblind, Powered Gesture Trunk lid
Driver Assistance Package <sup>5</sup>	Z68X	—	—	—	○	○	○	Adaptive Cruise Control (ACC) with Forward Alert, Advanced, Emergency Brake Assist with Queue Assist, Intelligent Emergency, Braking and Follow Mode, Surround Camera System, 360° Parking Aid, Traffic Sign Recognition and Adaptive Speed Limiter, Park Assist - Parallel, Perpendicular, & Parallel Exit, Blind Spot Assist
Black Design Package	Z93L	—	—	○	—	○	○	Radiator grille - Gloss Black insert with Gloss Black surround, Gloss Black side power vents, Gloss Black blades in R-Sport front bumper (R-Sport only), Gloss Black window surround (Prestige only)
Technology Package	Z80U	—	—	○	—	○	○	InControl Touch Pro™ - SSD based Navigation with 60GB memory and single slot in dash CD/DVD player, 10" capacitive Touchscreen <sup>1</sup> and Meridian 825W Surround Sound System (V32), Pro Services and Wi-Fi Hotspot, 12.3" Full Digital Instrument Panel

### STAND ALONE OPTIONS

	CODE	XE	PREMIUM	PRESTIGE	PORTFOLIO	R-SPORT	S	DESCRIPTION
Heated front windshield	H74A	P1	P1	○	○	○	○	—
Rear View Camera <sup>5</sup>	C14A	○	●	●	●	●	●	—
InControl Touch™ - SD Card-based mapping Navigation System and InControl Apps™ <sup>1</sup>	G61C	○	○	●	●	●	●	Refer to page 40
Head-up Display <sup>5</sup>	G62A	—	—	○	●	○	○	Refer to page 39
SiriusXM® Satellite Radio <sup>4</sup> (includes 3 month complimentary service)	B51D	○	○	○	●	●	●	—
InControl Wi-Fi™ with 3GB or 3 month complimentary data plan <sup>3</sup> (which ever comes first)	A44A	—	○	○	●	○	○	—
Adaptive Dynamics with Configurable Dynamics <sup>5</sup>	C35A	—	—	○	○	○	●	Refer to page 29
Powertrain debadging	B05H	NCO	NCO	NCO	NCO	NCO	—	—
Bright Metal Pedals		—	—	—	—	○	●	—
Illuminated Metal Treadplates with 'Jaguar' script		—	—	—	●	—	○	—





CONTENTS

PERSONALIZATION

LOCATE A RETAILER

BUILD YOUR OWN

# 3 CHOOSE YOUR COLOR

Configure your vehicle at JAGUARUSA.COM

\*Available from Autumn 2017.

SOLID

METALLIC

PREMIUM PALETTE

Fuji White

Narvik Black

Caldera Red\*

Yulong White

Santorini Black

Indus Silver

Corris Grey

Caesium Blue

Loire Blue

Firenze Red

Silicon Silver

Carpathian Grey

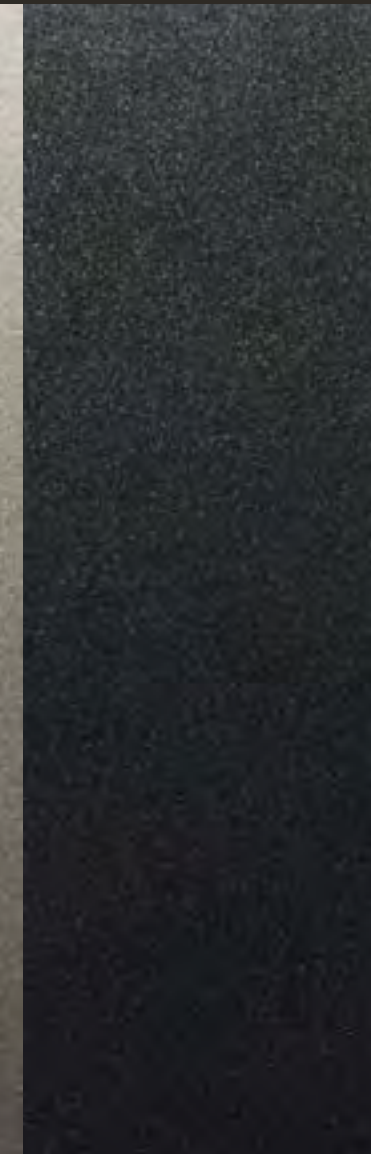
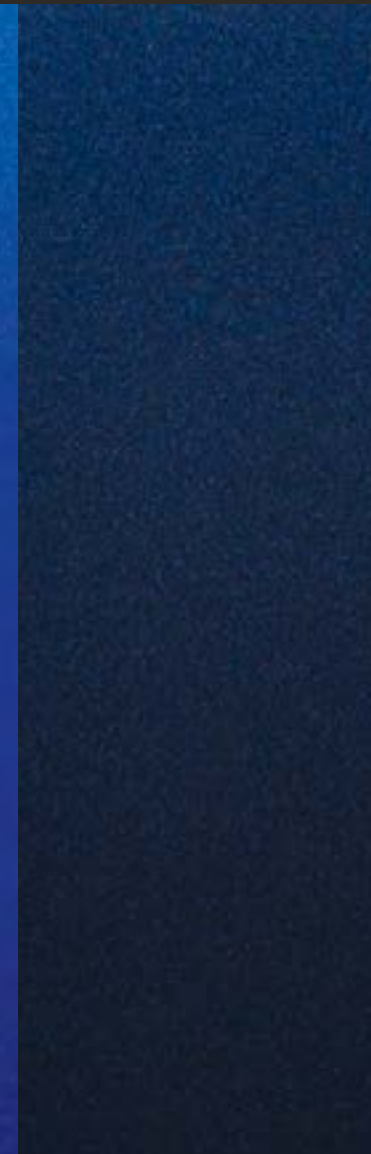
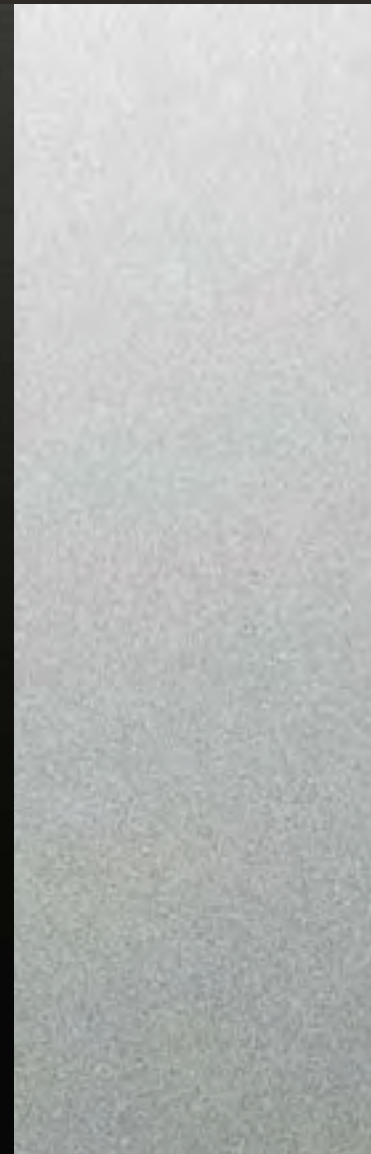
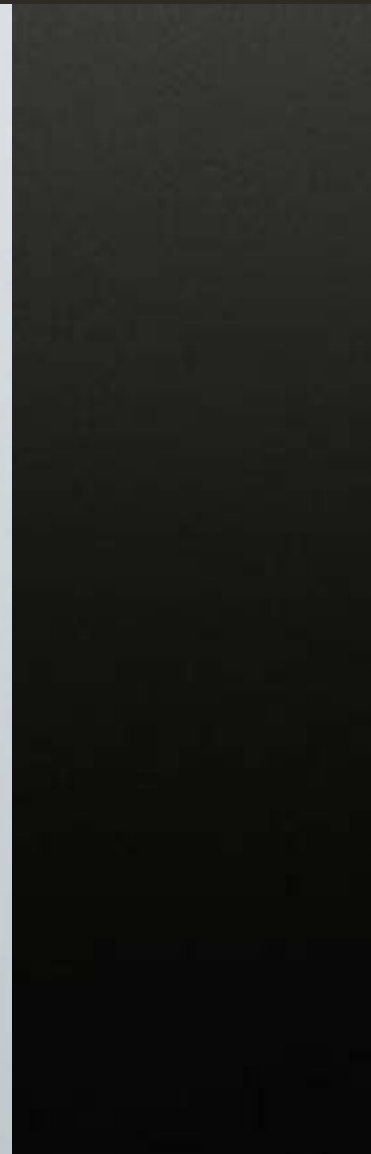
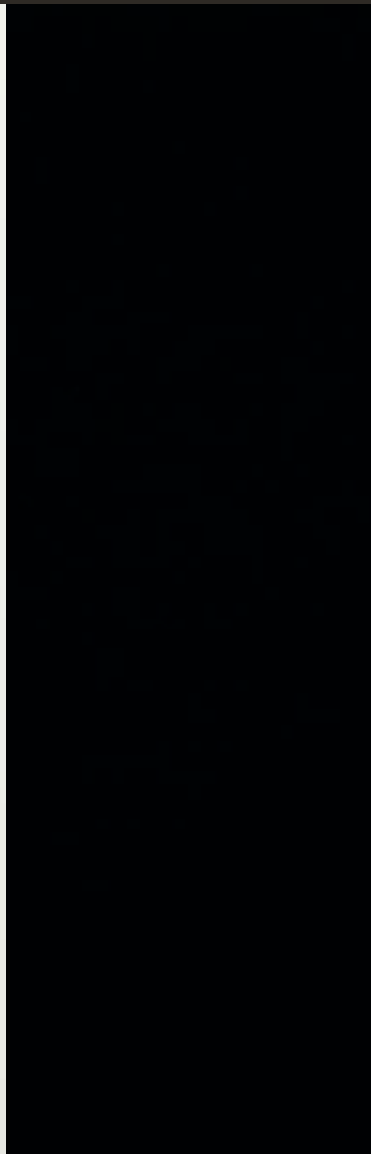
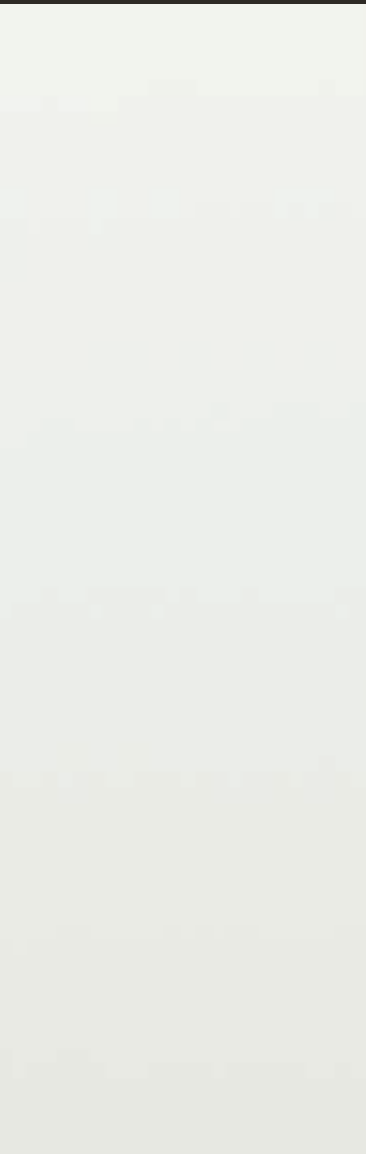

ENGINE

MODEL & PACKAGES

COLOR

WHEELS

INTERIOR

JAGUAR GEAR ACCESSORIES

TECHNICAL SPECIFICATIONS





CONTENTS

PERSONALIZATION

LOCATE A RETAILER

BUILD YOUR OWN

# 4 CHOOSE YOUR WHEELS

Configure your vehicle at JAGUARUSA.COM

	17" 5 SPOKE 'STYLE 5032'	17" 7 SPLIT-SPOKE 'STYLE 7010' <sup>**</sup>
ALLOY WHEEL FINISH	Sparkle Finish	Sparkle Finish
ALLOY WHEEL/SIZE	7.0J x 17"	7.0J x 17"
TIRE SIZE	225/50 R17	205/55 R17   225/50 R17
CODE	C53D	C53B
XE	●	—
PREMIUM	—	●
PRESTIGE	—	—
PORTFOLIO	—	—
R-SPORT	—	—
S	—	—

	18" 6 SPOKE 'STYLE 6006' <sup>**†‡</sup>	18" 7 SPLIT-SPOKE 'STYLE 7009' <sup>**</sup>	18" 7 SPLIT-SPOKE 'STYLE 7009' <sup>‡</sup>
ALLOY WHEEL FINISH	Sparkle Finish	Sparkle Finish	Black
ALLOY WHEEL/SIZE	7.5J x 18"	7.5J x 18"	7.5J x 18"
TIRE SIZE	225/45 R18	225/45 R18	225/45 R18
CODE	C52P	C52Q	C52S
XE	—	—	—
PREMIUM	●/○	—	—
PRESTIGE	●	—	○
PORTFOLIO	—	—	—
R-SPORT	—	●	○
S	—	—	—

	19" 5 SPLIT-SPOKE 'STYLE 5071' <sup>†‡</sup>	19" 15 SPOKE 'STYLE 1015'	19" 15 SPOKE 'STYLE 1015' <sup>†‡</sup>
ALLOY WHEEL FINISH	Sparkle Finish	Black/Diamond Turned	Sparkle Finish
ALLOY WHEEL/SIZE	7.5J x 19"   8.5J x 19"	7.5J x 19"   8.5J x 19"	7.5J x 19"   8.5J x 19"
TIRE SIZE	225/40 R19   255/35 R19	225/40 R19   255/35 R19	225/40 R19   255/35 R19
CODE	C52T	C52M	C52U
XE	—	—	—
PREMIUM	○	—	—
PRESTIGE	●	—	—
PORTFOLIO	—	—	●
R-SPORT	—	—	—
S	○	●	—

	19" 5 SPLIT-SPOKE 'STYLE 5031' <sup>**†‡</sup>	19" 5 SPLIT-SPOKE 'STYLE 5031' <sup>†</sup>	20" 10 SPOKE 'STYLE 1014' <sup>†</sup>
ALLOY WHEEL FINISH	Silver/Diamond Turned	Black	Silver/Diamond Turned
ALLOY WHEEL/SIZE	7.5J x 19"   8.5J x 19"	7.5J x 19"   8.5J x 19"	8J x 20"   9J x 20"
TIRE SIZE	225/40 R19   255/35 R19	225/40 R19   255/35 R19	235/35 R20   265/30 R20
CODE	C52V	C52W	C52K
XE	—	—	—
PREMIUM	—	—	—
PRESTIGE	○	○	—
PORTFOLIO	—	—	—
R-SPORT	●/○	○	—
S	○	—	○

● Standard ○ Option — Not Applicable

<sup>†</sup>Please see page 96 for further information. <sup>\*\*</sup>Standard feature on 20d and 25t derivatives as shown. <sup>†</sup>Optional feature on 30t derivatives as shown. <sup>‡</sup>Standard on 30t derivatives as shown. <sup>‡</sup>Optional feature on 20d and 25t derivatives as shown. Standard and optional features differ depending on engine selection. Please consult your local Jaguar Retailer for further details.



# 5 CHOOSE YOUR INTERIOR

Configure your vehicle at JAGUARUSA.COM

XE						
	SEAT WITH TONAL STITCH	FINISHER	UPPER FASCIA/ LOWER FASCIA	HEADLINING MORZINE	CARPET	INTERIOR TRIM CODES
Luxtec Seats	Ebony with Ebony	Gloss Black	Ebony	Light Oyster	Ebony	TR01
	Latte with Latte	Gloss Black	Ebony	Light Oyster	Ebony	TR02
	Light Oyster with Light Oyster	Gloss Black	Oyster	Light Oyster	Oyster	TR03

PREMIUM						
	SEAT WITH TONAL STITCH	FINISHER**	UPPER FASCIA/ LOWER FASCIA	HEADLINING MORZINE	CARPET	INTERIOR TRIM CODES
Luxtec Seats	Ebony with Ebony	Gloss Black	Ebony	Light Oyster	Ebony	TR01
	Latte with Latte	Gloss Black	Ebony	Light Oyster	Ebony	TR02
	Light Oyster with Light Oyster	Gloss Black	Oyster	Light Oyster	Oyster	TR03

PRESTIGE						
	SEAT WITH CONTRAST STITCH	FINISHER**	UPPER FASCIA/ LOWER FASCIA	HEADLINING MORZINE	CARPET	INTERIOR TRIM CODES
Grained Leather Seats	Ebony with Sienna Tan	Dark Satin Brushed Aluminum	Ebony with Ebony	Light Oyster	Ebony	TR05
	Latte with Ebony	Dark Satin Brushed Aluminum	Ebony with Latte	Light Oyster	Ebony	TR06
	Light Oyster with Pistachio	Dark Satin Brushed Aluminum	Oyster with Light Oyster	Light Oyster	Oyster	TR07

PORTFOLIO						
	SEAT WITH TONAL STITCH	FINISHER	UPPER FASCIA/ LOWER FASCIA	HEADLINING MORZINE	CARPET	INTERIOR TRIM CODES
Perforated Windsor Leather Seats	Sienna Tan with Sienna Tan	Gloss Figured Ebony	Ebony with Ebony/Sienna Tan	Light Oyster	Ebony	TR18

\*\*Optional finishers are available.

R-SPORT						
	DUOTONE SEAT WITH CONTRAST STITCH	FINISHER**	UPPER FASCIA/ LOWER FASCIA	HEADLINING MORZINE	CARPET	INTERIOR TRIM CODES
Perforated Grained Leather Sports Seats	Ebony/Ebony with Light Oyster	Etched Aluminum	Ebony with Light Oyster	Ebony	Ebony	TR63
	Ebony/Pimento Red with Pimento Red	Etched Aluminum	Ebony with Pimento Red	Ebony	Ebony	TR10
	Ebony/Eclipse with Eclipse	Etched Aluminum	Ebony with Eclipse	Ebony	Ebony	TR12
	Ebony/Light Oyster with Light Oyster	Etched Aluminum	Ebony with Light Oyster	Ebony	Ebony	TR13

S						
	DUOTONE SEAT WITH CONTRAST STITCH	FINISHER**	FASCIA WITH CONTRAST STITCH	HEADLINING MORZINE	CARPET	INTERIOR TRIM CODES
Standard	Ebony/Ebony with Light Oyster	Meshed Aluminum	Ebony with Light Oyster	Ebony	Ebony	TR21
	Pimento Red/Ebony with Ebony	Meshed Aluminum	Ebony with Pimento Red	Ebony	Ebony	TR14
	Eclipse/Ebony with Ebony	Meshed Aluminum	Ebony with Eclipse	Ebony	Ebony	TR15
	Light Oyster/Ebony with Ebony	Meshed Aluminum	Ebony with Light Oyster	Ebony	Ebony	TR16

Optional						
	DUOTONE SEAT WITH CONTRAST STITCH	FINISHER**	FASCIA WITH CONTRAST STITCH	HEADLINING MORZINE	CARPET	INTERIOR TRIM CODES
Perforated Grained Leather Sport Seats	Ebony/Ebony with Light Oyster	Meshed Aluminum	Ebony with Light Oyster	Ebony	Ebony	TR21
	Pimento Red/Ebony with Ebony	Meshed Aluminum	Ebony with Pimento Red	Ebony	Ebony	TR14
	Eclipse/Ebony with Ebony	Meshed Aluminum	Ebony with Eclipse	Ebony	Ebony	TR15
	Light Oyster/Ebony with Ebony	Meshed Aluminum	Ebony with Light Oyster	Ebony	Ebony	TR16

# 5 CHOOSE YOUR INTERIOR

Configure your vehicle at [JAGUARUSA.COM](http://JAGUARUSA.COM)

Interior shown: Ebony Luxtec seats with Gloss Black finisher, Light Oyster headlining and Ebony fascia.



## XE & PREMIUM INTERIOR COLOR COMBINATIONS

1	2	3	4	5
SEAT	FINISHER	HEADLINING	FASCIA	CARPET
 Ebony	 Gloss Black	 Light Oyster	 Ebony	 Ebony
 Latte	 Gloss Black	 Light Oyster	 Ebony	 Ebony
 Light Oyster	 Gloss Black	 Light Oyster	 Oyster	 Oyster

# 5 CHOOSE YOUR INTERIOR

Configure your vehicle at JAGUARUSA.COM

Interior shown: Latte leather seats with Ebony contrast stitch, Dark Satin Brushed Aluminum finisher, Light Oyster headlining, Ebony upper fascia and Latte lower fascia.



## PRESTIGE INTERIOR COLOR COMBINATIONS

1	2	3	4	5
SEAT WITH CONTRAST STITCH	FINISHER**	HEADLINING	FASCIA UPPER/LOWER	CARPET
Ebony with Sienna Tan	Dark Satin Brushed Aluminum	Light Oyster	Ebony with Jet	Ebony
Latte with Ebony	Dark Satin Brushed Aluminum	Light Oyster	Ebony with Latte	Ebony
Light Oyster with Pistachio	Dark Satin Brushed Aluminum	Light Oyster	Oyster with Light Oyster	Oyster

### FINISHER OPTIONS

Gloss Figured Ebony

\*\*Console finisher is Gloss Black.

# 5 CHOOSE YOUR INTERIOR

Configure your vehicle at [JAGUARUSA.COM](http://JAGUARUSA.COM)

Interior shown: Sienna Tan leather seats with Herringbone perforations and Sienna Tan tonal stitch. Gloss Figured Ebony veneer, Light Oyster headlining, Ebony upper fascia and Sienna Tan lower fascia.



## PORTFOLIO

### INTERIOR COLOR COMBINATIONS

#### STANDARD

①	②	③	④	⑤
SEAT WITH TONAL STITCH	FINISHER**	HEADLINING	FASCIA UPPER WITH TONAL STITCH/LOWER	CARPET
Sienna Tan with Sienna Tan	Gloss Figured Ebony	Light Oyster	Ebony with Ebony/Sienna Tan	Ebony

\*\*Console finisher is Gloss Black.

# 5 CHOOSE YOUR INTERIOR

Configure your vehicle at [JAGUARUSA.COM](http://JAGUARUSA.COM)

Interior shown: Ebony perforated leather sport seats with Light Oyster contrast stitch. Etched Aluminum finisher, Ebony headlining and Ebony fascia with Light Oyster contrast stitch.



## R-SPORT INTERIOR COLOR COMBINATIONS

1	2	3	4	5
SEAT WITH CONTRAST STITCH	FINISHER**	HEADLINING	FASCIA	CARPET
Ebony/Ebony with Light Oyster	Etched Aluminum	Ebony	Ebony with Light Oyster	Ebony
Ebony/Pimento Red with Pimento Red	Etched Aluminum	Ebony	Ebony with Pimento Red	Ebony
Ebony/Eclipse with Eclipse	Etched Aluminum	Ebony	Ebony with Eclipse	Ebony
Ebony/Light Oyster with Light Oyster	Etched Aluminum	Ebony	Ebony with Light Oyster	Ebony

### FINISHER OPTIONS

Satin Burl Ash or Carbon Fiber

\*\*Console finisher is Gloss Black.

# 5 CHOOSE YOUR INTERIOR

Configure your vehicle at [JAGUARUSA.COM](http://JAGUARUSA.COM)

Interior shown: Pimento Red leather sport seats with Ebony suedecloth inserts and Ebony contrast stitch. Meshed Aluminum finisher, Ebony headlining and Ebony fascia with Pimento Red contrast stitch.



## S INTERIOR COLOR COMBINATIONS

### STANDARD

1	2	3	4	5
DUOTONE SEAT WITH CONTRAST STITCH	FINISHER**	HEADLINING	FASCIA WITH CONTRAST STITCH	CARPETS
Ebony/Ebony with Light Oyster	Meshed Aluminum	Ebony	Ebony with Light Oyster	Ebony
Pimento Red/Ebony with Ebony	Meshed Aluminum	Ebony	Ebony with Pimento Red	Ebony
Eclipse/Ebony with Ebony	Meshed Aluminum	Ebony	Ebony with Eclipse	Ebony
Light Oyster/Ebony with Ebony	Meshed Aluminum	Ebony	Ebony with Light Oyster	Ebony

### OPTIONS

HEADLINING	FINISHER
Light Oyster	Satin Burl Ash or Carbon Fiber

\*\*Console finisher is Gloss Black.



# 5 CHOOSE YOUR INTERIOR

Configure your vehicle at [JAGUARUSA.COM](http://JAGUARUSA.COM)

Interior shown: Ebony perforated leather seats with Light Oyster contrast stitch.  
 Meshed Aluminum finisher, Ebony headlining and Ebony fascia with Light Oyster contrast stitch.



## S INTERIOR COLOR COMBINATIONS

### OPTIONS

1	2	3	4	5
DUOTONE SEAT WITH CONTRAST STITCH	FINISHER**	HEADLINING	FASCIA WITH CONTRAST STITCH	CARPET
Ebony/Ebony with Light Oyster	Meshed Aluminum	Ebony	Ebony with Light Oyster	Ebony
Pimento Red/Ebony with Ebony	Meshed Aluminum	Ebony	Ebony with Pimento Red	Ebony
Eclipse/Ebony with Ebony	Meshed Aluminum	Ebony	Ebony with Eclipse	Ebony
Light Oyster/Ebony with Ebony	Meshed Aluminum	Ebony	Ebony with Light Oyster	Ebony

### OPTIONS

HEADLINING	FINISHER
Light Oyster	Satin Burl Ash or Carbon Fiber

\*\*Console finisher is Gloss Black.



CONTENTS

PERSONALIZATION

LOCATE A RETAILER

BUILD YOUR OWN

# 5 CHOOSE YOUR INTERIOR

Configure your vehicle at [JAGUARUSA.COM](http://JAGUARUSA.COM)

Gloss Black

Dark Satin Brushed Aluminum

Etched Aluminum

Meshed Aluminum

Carbon Fiber

Satin Burl Ash

Gloss Figured Ebony

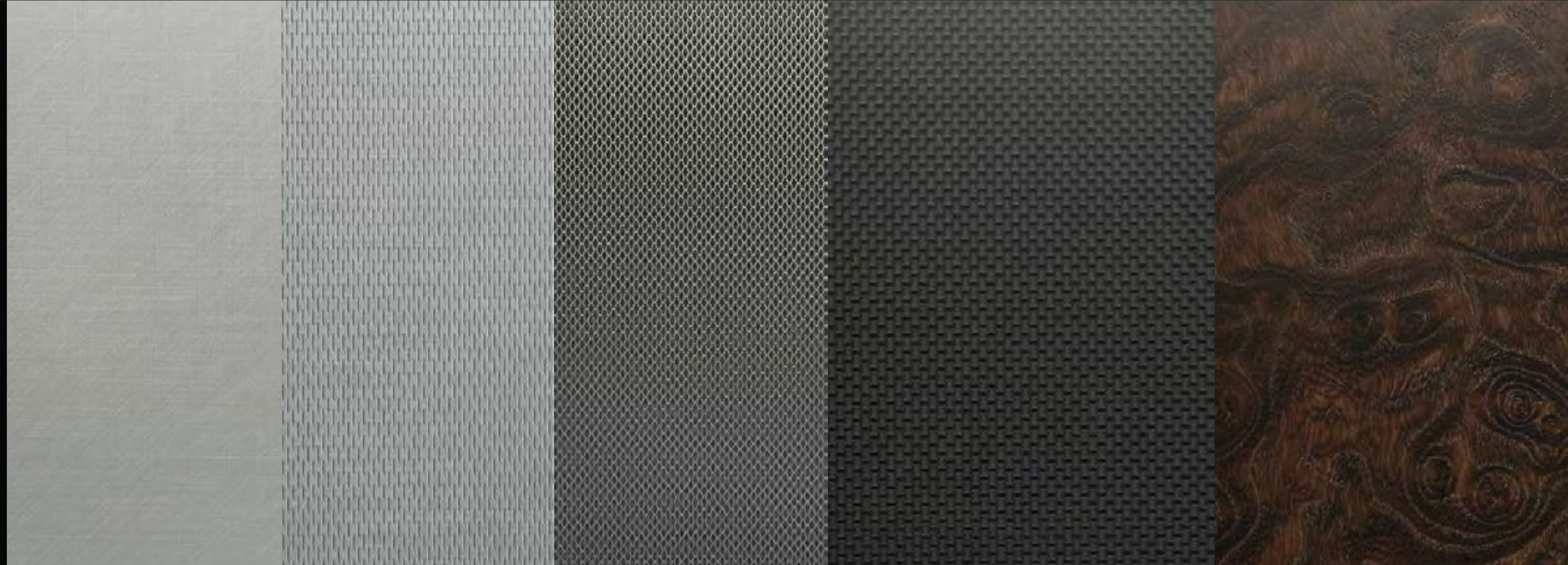

ENGINE

MODEL & PACKAGES

COLOR

WHEELS

INTERIOR

JAGUAR GEAR ACCESSORIES

TECHNICAL SPECIFICATIONS



# 6 CHOOSE YOUR JAGUAR GEAR ACCESSORIES

To find out more about the full range of Jaguar Accessories, please refer to your Jaguar Retailer or go to JAGUARUSA.COM



**Roof Mounted Cycle Carrier\*\*  
C2A1539**

An easy to fit, roof mounted, lockable cycle carrier which carries one bike per holder. A maximum of three holders can be fitted.

\*\*Requires roof cross bars T4N4709.

VEHICLE SHOWN: XE S IN FIRENZE RED WITH OPTIONAL EQUIPMENT



**Personalized Illuminated Sill Treadplates  
T4N7511**

Elegantly styled stainless steel sill treadplate finishers for driver or passenger doors. Illuminates when either the driver or passenger doors are opened. Highlighted by soft Phosphor Blue lighting. Allows customer to specify a monochrome 'motif' in a choice of approved typefaces/scripts.



**Aluminum Gearshift Paddles  
T2R6547MMU**

Replacement steering wheel gearshift paddles offered in a premium aluminum material providing a high quality finish to a key contact point in the vehicle. Manufactured from billet machined aluminum, the paddles are hand brushed for a premium finish and anodized to ensure they will not deteriorate with wear.



**iPad® Holder  
T2H7757**

Jaguar branded iPad® holder mounts to front seat headrests providing a flexible solution for rear seat entertainment. Quick release design ensures iPad® can be fitted or removed quickly and easily.



**Sport Pedal Covers  
T2H3746**

Made from stainless steel and rubber, the pedal kit fits securely over existing pedals for a contemporary, sporting appearance.



**Premium Carpet Mats  
T4N7146 PVJ - Jet  
T4N7146 AMT - Oyster**

Luxurious, tailored 2,050g/m<sup>2</sup> pile front carpet mats with embossed Jaguar logo and Nubuck edge binding. The premium mats provide a well appointed finishing touch to the interior.



**Premium Luggage Compartment Carpet Mat  
T4N7147PVJ**

Luxurious soft luggage mat in Jet Black with the Jaguar logo. Deep premium 2,050g/m<sup>2</sup> pile with Nubuck edging and Dove contrast stitch.

## 6 CHOOSE YOUR JAGUAR GEAR ACCESSORIES

Configure your vehicle at [JAGUARUSA.COM](http://JAGUARUSA.COM)



**Gloss Black Side Power Vent**  
**T4N5176 - Left Side**  
**T4N5178 - Right Side**  
 Gloss Black side power vents provide a dynamic exterior styling enhancement.



**Carbon Fiber Side Power Vent**  
**T2H6208 - Left Side**  
**T2H6209 - Right Side**  
 High-grade Carbon Fiber side power vents provide a performance-inspired styling upgrade.



**Sports Rear Valance\*\***  
**T4N5633**  
 The Sports rear valance gives the XE an athletic look.



**Roof Cross Bars**  
**T4N4709**  
 Jaguar branded cross bars required for fitting all roof carrying equipment. Engineered specifically for your vehicle.



**Watersports Carrier\*\***  
**C2Z21730**  
 A versatile system for transporting a variety of water sports equipment including surfboard, kayak or sailboard. Tilts to facilitate loading/unloading.



**Roof Sport Box\***  
**C2C41627**  
 Spacious 11 cubic feet capacity lockable roof box designed for sports equipment, measuring 81 x 33 x 13 inches.



**Gloss Black Mirror Cover**  
**C2D6066PEC - Left Side**  
**C2D6067PEC - Right Side**  
 Gloss Black mirror covers accentuate the dynamic design of the exterior mirrors.



**Carbon Fiber Mirror Cover**  
**C2P24176 - Left Side**  
**C2P24177 - Right Side**  
 High-grade Carbon Fiber mirror covers provide a performance-inspired styling upgrade.



**Chrome Mirror Cover**  
**C2D5489 - Left Side**  
**C2D5488 - Right Side**  
 Chrome mirror covers accentuate the stylish design of the exterior mirrors.



**Chrome Front Splitter**  
**T4N7599**  
 Give the XE an even more stylish look with this bright finish front splitter blade. Body-colored rear spoiler is also available. (T4N5462LML)



**Rear Splash Guards**  
**T4N7514**  
 Jaguar branded, rear splash guards complement the lines of your vehicle and provide protection from dirt and stone chippings.



**All-Weather Car Cover**  
**T4N7502**  
 All-weather tailored cover for the XE with the Jaguar logo. Protect your XE from the elements, including showers, frost and dust. Quick and easy to fit.

\*Requires roof cross bars T4N4709. \*\*Available on 2.0 Gas 240HP only. Not applicable with R-Sport, standard on S. Not applicable with towing.



# TECHNICAL SPECIFICATIONS

Configure your vehicle at [JAGUARUSA.COM](http://JAGUARUSA.COM)

ENGINES		20D 2.0 LITER 180 4-CYLINDER TURBOCHARGED DIESEL		25T 2.0 LITER 247 4-CYLINDER TURBOCHARGED GAS	
Capacity	cc	1,999		1,997	
Maximum power	hp	180		247	
@rev/min	rpm	4,000		5,500	
Maximum torque	lb.ft.	318		269	
@rev/min	rpm	1,750-2,500		1,200-4,500	
Transmission		8-speed automatic		8-speed automatic	
PERFORMANCE*7		RWD		AWD	
0-60 mph	seconds	7.5		6.0	
Top speed	mph	120		120	
DIMENSIONS					
Overall length	in	183.9		183.9	
Overall width (inc. mirrors)	in	81.7		81.7	
Overall width (exc. mirrors)	in	77.4		77.4	
Overall height	in	55.8 (RWD) 56.1 (AWD)		55.8 (RWD) 56.1 (AWD)	
Wheelbase	in	111.6		111.6	
Front track	in	62.8-63.3		62.8-63.3	
Rear track	in	62.4-63.3		62.4-63.3	
Ground clearance	in	4.3 (RWD) 4.7 (AWD)		4.3 (RWD) 4.7 (AWD)	
Turning circle diameter (curb-to-curb)	ft	36.8		36.8	
Trunk volume	cu-ft	15.9		15.9	
Tank capacity (usable)	US gallons	14.8		16.6	
ENGINE AVAILABILITY					
XE		●		●	
PREMIUM		●		●	
PRESTIGE		●		●	
PORTFOLIO		—		—	
R-SPORT		●		●	
S		—		—	
WEIGHT†		RWD		AWD	
Weight from	lb	3,320		3,560	
Gross vehicle weight	lb	4,707		4,916	

ENGINES		30T 2.0 LITER 296 4-CYLINDER TURBOCHARGED GAS		S 3.0 LITER V6 380 SUPERCHARGED GAS	
Capacity	cc	1,997		2,995	
Maximum power	hp	296		380	
@rev/min	rpm	5,500		6,500	
Maximum torque	lb.ft.	295		332	
@rev/min	rpm	1,500-4,500		3,500-5,000	
Transmission		8-speed automatic		8-speed automatic	
PERFORMANCE*7		RWD		AWD	
0-60 mph	seconds	5.4		5.2	
Top speed	mph	120		121	
DIMENSIONS					
Overall length	in	183.9		183.9	
Overall width (inc. mirrors)	in	81.7		81.7	
Overall width (exc. mirrors)	in	77.4		77.4	
Overall height	in	55.8 (RWD) 56.1 (AWD)		55.8 (RWD) 56.1 (AWD)	
Wheelbase	in	11.6		111.6	
Front track	in	62.8-63.3		62.8-63.3	
Rear track	in	62.4-63.3		62.4-63.3	
Ground clearance	in	4.3 (RWD) 4.7 (AWD)		4.3 (RWD) 4.7 (AWD)	
Turning circle diameter (curb-to-curb)	ft	36.8		36.8	
Trunk volume	cu-ft	15.9		15.9	
Tank capacity (usable)	US gallons	16.6		16.6	
ENGINE AVAILABILITY					
XE		—		—	
PREMIUM		●		—	
PRESTIGE		●		—	
PORTFOLIO		●		—	
R-SPORT		●		—	
S		—		●	
WEIGHT†		RWD		AWD	
Weight from	lb	3,445		3,570	
Gross vehicle weight	lb	4,760		4,870	

● Available — Not Available  
 \*Please see page 96 for further information.  
 †Weights reflect vehicles to standard specifications. Optional extras increase weight.

## DIMENSIONS

Overall Width (inc mirrors) 81.7 inches

Overall Width (exc mirrors) 77.4 inches

Trunk Volume 15.9 cu-ft

**Turning Circle**  
Curb-to-Curb 36.8 ft



62.8 in - 63.3 in  
77.4 in



55.8 - 56.1 in  
62.4 in - 63.3 in  
4.3 in - 4.7 in



111.6 in  
183.9 in

Dimensions were measured with vehicle at unladen mass  
(measured by VDA standard test method using 200 x 100 x 50mm blocks).  
VEHICLE SHOWN: XE R-SPORT IN YULONG WHITE WITH OPTIONAL EQUIPMENT

## JAGUAR EXPERIENCE

There's no better way to get to know Jaguar than by taking a drive. The Jaguar Experience offers a range of unique opportunities to really find out what it feels like to get the most out of a Jaguar. Our track experiences allow you to push yourself and cars from the incredible Jaguar range to the limit. Jaguar Experience also offers the opportunity to see a Jaguar brought to life during a tour of one of our UK manufacturing facilities.

Find out more by visiting [JAGUARUSA.COM](http://JAGUARUSA.COM)



### BEHIND THE SCENES

Our factory tours give you the unique opportunity to experience the whole process of how our cars are brought to life – from the molding of sheet metal to those intricate final touches. At our state-of-the-art production facilities, you'll get to see how skilled technicians and sophisticated machines work seamlessly together to perfect some of Jaguar's most breathtaking cars – from the powerful F-TYPE to the groundbreaking F-PACE performance SUV.

Find out more at [JAGUARUSA.COM](http://JAGUARUSA.COM)

### DRIVING EXPERIENCES

The opportunity to drive the latest Jaguar cars at their limits, or relive iconic Jaguar history, is rare. Jaguar Driving Experiences offer unique driving adventures you will never forget. Imagine yourself behind the wheel of our highest performing Jaguar models, on a private track, with a Jaguar Experience Instructor at your side. This is the Jaguar Performance Driving Academy.

Find out more at [JAGUARUSA.COM](http://JAGUARUSA.COM)



### ICONIC EXPERIENCES

Take your driving to the next level with our international adventures facing extreme on-road, and off-road, conditions. Our Iconic Experiences offer journeys and challenges that will test and develop your performance driving skills. Every year, Jaguar customers and enthusiasts join us for our luxury Ice Driving Experience. The exclusive ski resort in Gstaad, Switzerland, is the perfect location to enjoy the thrill of performance driving on ice. Our Ice Driving Experience is a two-day getaway held each winter. You can get a flavor of the event below. Then, if you'd like to be part of it in the next experience, we can keep you posted.

Find out more at [JAGUARUSA.COM](http://JAGUARUSA.COM)

# THE WORLD OF JAGUAR

Choose an XE and you're joining the exciting World of Jaguar. It makes owning and driving carefree and easy, as well as providing a range of exclusive services and lifestyle products.



## JAGUAR ELITECARE

Enjoy your Jaguar with complete peace of mind. The XE is now backed by Jaguar EliteCare<sup>®</sup>, our exceptional 5 year / 60,000 mile coverage program including New Vehicle Limited Warranty, Complimentary Scheduled Maintenance, Roadside Assistance and InControl Remote & Protect<sup>™</sup>.

## NEW VEHICLE LIMITED WARRANTY

The New Vehicle Limited Warranty (the "Warranty") lets you enjoy your driving with peace of mind and runs for a best in class 5 years or 60,000 miles, whichever occurs first. The Warranty is fully transferable to subsequent owners and remains in effect throughout the Warranty coverage period.



## COMPLIMENTARY SCHEDULED MAINTENANCE\*\*

Relax in the knowledge that long-term performance is assured with the Complimentary Scheduled Maintenance Coverage. It covers factory recommended scheduled servicing as detailed in the "Passport to Service" for 5 years or 60,000 miles, whichever occurs first\*\*. A Service Interval Indicator will appear every 16,000 miles or every 12 months, to remind you to take advantage of your complimentary maintenance.

## GENUINE PARTS

Jaguar Genuine Parts are designed, tested and manufactured to our uncompromising standards for quality, fit and durability. Each part is engineered specifically for the XE to contribute to optimum performance and to help maximize its lifespan.



## ROADSIDE ASSISTANCE

Jaguar Optimized Assistance provides assistance in motoring emergencies, from immobilization due to breakdown or accident to minor problems such as punctures. You can rely on our roadside assistance, whatever the situation, anywhere in North America during the vehicles warranty period.



## JAGUAR MAGAZINE

This is our own vibrant, cosmopolitan and contemporary magazine. Produced by a team of enthusiastic designers and feature writers, it goes behind the scenes at Jaguar as well as providing insight into the world of luxury, design, style and travel. You can enjoy Jaguar Magazine twice a year completely free of charge for the first three years. Ask your retailer to ensure that you receive your copy.

## JAGUAR COLLECTION

The latest range from the Jaguar Collection has been crafted with the same design execution and attention to detail that goes into all of our cars. This is evident in our clothing range, premium leather items and luxury travel goods. To celebrate Jaguar's heritage we also have a collection that honors past achievements and features race-inspired gift items and apparel. Visit [shop.jaguarusa.com](http://shop.jaguarusa.com) to browse the latest Jaguar Collection.

\*Please see page 96 for further information.

\*\*Servicing your vehicle at the specified interval is critical to maintaining its long-term durability. Failure to perform scheduled maintenance within 1,000 miles of the recommended interval may void the Warranty under certain circumstances.





CONTENTS

PERSONALIZATION

LOCATE A RETAILER

BUILD YOUR OWN

# GLOSSARY

## A

**AUDIO EQUALIZATION**  
Audio Equalization lets you fine tune the sound of your car's audio system by giving you tone adjustment not covered by standard treble, mid-range, and bass controls.

## D

**DAMPERS/DAMPING**  
Dampers absorb forces acting on the suspension for greater ride comfort and control. Dampers are also known as shock absorbers.

**DSP AMPLIFIER**  
Meridian's Digital Signal Processing (DSP) technology analyzes a range of variables that may impact audio quality, then processes them using sophisticated algorithms and adapts the system's output accordingly. This enables a level of powerful, authentic performance impossible with a conventional sound system.

## E

**ECO MODE**  
Eco Mode encourages fuel efficient driving by reducing throttle sensitivity, selecting more economical engine mapping and, on manual vehicles, advising of gear shifts. It also reduces fuel consumption by reducing the energy demands placed on the engine by climate control and audio systems.

## J

**JAGUARDRIVE CONTROL**  
Interacts with the Dynamic Stability Control system, engine and transmission management systems to alter the characteristics of the engine mapping, gear shifts and brakes. It offers different modes designed to optimize the vehicle's response to particular driving conditions and styles.

**"J" BLADE DAYTIME RUNNING LIGHTS**  
"J" blade Daytime Running Lights are separate LED running lights, in a distinctive 'J' shape, built into the headlights. They emphasize the striking on-road style of Jaguar vehicles.

**JAGUARDRIVE SELECTOR**  
The JaguarDrive Selector rises from the center console on start up. It is a rotary shifter used with automatic transmissions that allows you to quickly shift between drive modes.

## M

**MHL CONNECTION**  
A Mobile High-Definition Link (MHL) enables connection between a personal device and the InControl infotainment system. It is designed for seamless transfer of audio-visual data.

## T

**10" MULTI-TOUCHSCREEN WITH MULTI-TOUCH GESTURES**  
The multi-touch functionality of Touch Pro 10" display allows the screen to recognize multiple points of contact. This provides direct control of the system's features in a more natural, intuitive way, enabling gestures such as pinch and zoom.

**TURBOCHARGED DIESEL**  
Diesel engine with a turbocharger. A turbocharger is a forced induction device powered by exhaust gases. Turbocharging produces higher power outputs, lower emissions levels, and improved efficiency and refinement compared to similar capacity naturally aspirated engines.

## X

**XENON HEADLIGHTS**  
Xenon headlights offer improved illumination and feature LED "J" blade Daytime Running Lights for a striking on road style.

## \*DISCLAIMERS

<sup>1</sup>Do not use Jaguar InControl® features under conditions that will affect your safety or the safety of others. Driving while distracted can result in loss of vehicle control.

<sup>2</sup>Driving while distracted can result in loss of vehicle control. Do not operate, adjust or view the navigation or multimedia systems under conditions that will affect your safety or the safety of others. Only use mobile phones, and other devices, even with voice commands, when it is safe to do so.

<sup>3</sup>The Wi-Fi Hotspot is intended for passenger use only. InControl® features may require an additional subscription with separate terms and conditions.

<sup>4</sup>A 3-month trial subscription to the SiriusXM® All Access package is included with the vehicle, which gives you access to 175+ channels of premium programming. Plus you can stream SiriusXM® on your computer, smartphone or tablet - it's included in your trial. If you decide to continue service after your trial, the subscription plan you choose will automatically renew thereafter and you will be charged according to your chosen payment method at then-current rates. Fees and taxes apply. To cancel you must call SiriusXM® at 1-866-635-2349. See the SiriusXM® Customer Agreement for complete terms at siriusxm.com. All fees and programming are subject to change. SiriusXM® Satellite Radio is not available in Alaska, Hawaii, or Puerto Rico.

<sup>5</sup>These features are not a substitute for driving safely with due care and attention and will not function under all circumstances, speeds, weather and road conditions, etc. Driver should not assume that these features will correct errors of judgment in driving. Please consult the owner's manual or your local Jaguar Retailer for more details.

<sup>6</sup>Please remember that the safety belts in a vehicle constitute the primary protection system for driver and passengers in collisions. Airbags are not designed to deploy in all collisions. The airbag Supplemental Restraint System (SRS) is a supplement to the safety belts and is designed to work as a system with the safety belts. Although airbags provide additional protection, airbags without safety belts do not provide optimal protection in a crash. Always wear your safety belts. Children younger than 13 years old should always be properly restrained in a back seat, away from airbags. Never place an infant seat in the front seat.

<sup>7</sup>Always follow local speed limits.

<sup>8</sup>For complete details regarding Jaguar EliteCare coverage, visit JAGUARUSA.COM, call 1.800.4.JAGUAR or visit your local Jaguar Retailer.



## IMPORTANT NOTICE

Jaguar Land Rover Limited is constantly seeking ways to improve the specification, design and production of its vehicles and alterations take place continually. While every effort is made to produce up-to-date literature, this brochure should not be regarded as an infallible guide to current specifications, nor does it constitute an offer for the sale of any particular vehicle. Distributors and Retailers are not agents of Jaguar Land Rover Limited by any express or implied undertaking or representation. Comparisons are based on manufacturer's own data and testing prior to publication.

## COLORS

Print and online colors are representative only.

## ENVIRONMENTAL INNOVATION AT JAGUAR

F-PACE, XF, XE, XJ and F-TYPE innovative use of lightweight aluminum, which incorporates up to 50% closed-loop recycled material from the manufacturing process of the body structures, provides considerable performance benefits. This includes improved fuel consumption and less CO<sub>2</sub> emissions during the use phase of the Life Cycle due to lighter structures. Our on-going target is to ensure scrap aluminum reclaimed from our stamping process is to be segregated and recycled through a closed loop system and incorporated back into the same grade quality aluminum sheet, therefore reducing CO<sub>2</sub> emissions, versus the use of virgin aluminum sheets, during the production phase of the Life Cycle.

Jaguar is committed to reducing dependency on fossil fuels, using fewer natural resources and creating less waste as part of our approach to responsible and sustainable business development, called Environmental Innovation.

The company plan includes ongoing reduction in CO<sub>2</sub> emissions & the use of natural resources and at the end of 2014 we have achieved a 28% reduction in operating CO<sub>2</sub> emissions, 25% in the Company's European fleet average tailpipe emissions, 75% in waste to landfill, logistics efficiencies (18%) and water consumption (10%), all based on per vehicle built since 2007. In addition the manufacturing assembly CO<sub>2</sub> emissions of each Jaguar built in the UK since 2009, is 100% offset as part of our 2020 strategy for carbon neutral manufacturing assembly and since 2013 carbon-for-development projects form a key part of the company's Global Corporate Social Responsibility (CSR) program.

For each ton of CO<sub>2</sub> emitted in the assembly process, the company invests in emissions reductions projects that reduce an equivalent ton of CO<sub>2</sub> elsewhere and provide social and humanitarian benefits at the same time. Since 2013 the program has offset 800,000 ton of CO<sub>2</sub> and improved the lives of over 2 million people from our award winning Lifestraw carbon-for-water emissions reduction program.

Taking into account the company's global sales growth and increased investment in more efficient operating facilities, we are proud to have delivered and in some cases exceeded our Environmental Innovation targets as planned between 2012-2015 But it doesn't stop there. Our manufacturing facilities have been certified to ISO14001 since 1998 and in 2013 the Company was recognized as the UK's Responsible Business of the Year by leading CR index, Business in the Community. In 2014 we built on this success through the Queens award for Enterprise in Sustainable Development for 2014.

Looking forward, we have developed our 2020 vision for sustainable business growth that focuses on continued improvements in operating & tailpipe CO<sub>2</sub> emissions, carbon neutral manufacturing and zero waste. The company will also improve the lives of 12 million people by 2020 as part of the global Corporate Social Responsibility program.

Meridian is a trademark of Meridian Audio Limited.  
AdBlue is a registered trademark of Verband der Automobilindustrie e. V. (VDA).  
The Bluetooth. word mark and logos are owned by the Bluetooth SIG, Inc. and any use of such marks by Jaguar Land Rover Limited is under license.  
iPod, iPod touch and iPad are trademarks of Apple Inc, registered in the US and other countries.

**VEHICLE SHOWN FRONT COVER: XE S IN FIRENZE RED WITH OPTIONAL EQUIPMENT**  
**VEHICLE SHOWN BACK COVER: XE R-SPORT IN YULONG WHITE WITH OPTIONAL EQUIPMENT**  
© 2017 Jaguar Land Rover North America, LLC

Jaguar Land Rover North America, LLC  
555 MacArthur Boulevard  
Mahwah, NJ 07430-2327  
JAGUARUSA.COM

1X7601820CCSBUSENO1P





18.5MY XE  
JNA18.5001XE

