



ABOVE & BEYOND

CONTENTS

SPECIFICATION

LOCATE A RETAILER

BUILD YOUR OWN

RANGE ROVER SPORT

2017



ABOVE & BEYOND





ABOVE & BEYOND

CONTENTS

SPECIFICATION

LOCATE A RETAILER

BUILD YOUR OWN



BY APPOINTMENT TO
HM THE QUEEN
MANUFACTURERS OF
MOTOR VEHICLES
JAGUAR LAND ROVER LIMITED
COVENTRY



BY APPOINTMENT TO
HRH THE DUKE OF EDINBURGH
MANUFACTURERS OF
MOTOR VEHICLES
JAGUAR LAND ROVER LIMITED
COVENTRY



BY APPOINTMENT TO
HRH THE PRINCE OF WALES
MANUFACTURERS OF
MOTOR VEHICLES
JAGUAR LAND ROVER LIMITED
COVENTRY



ABOVE & BEYOND

Ever since the first Land Rover vehicle was conceived in 1947, we have built vehicles that challenge what is possible. These in turn have challenged their owners to explore new territories and conquer difficult terrains. Our vehicles epitomize the values of the designers and engineers who have created them. Each one instilled with iconic British design cues, delivering capability with composure. Which is how we continue to break new ground, defy conventions and encourage each other to go further. Land Rover truly enables you to make more of your world, to go above and beyond.

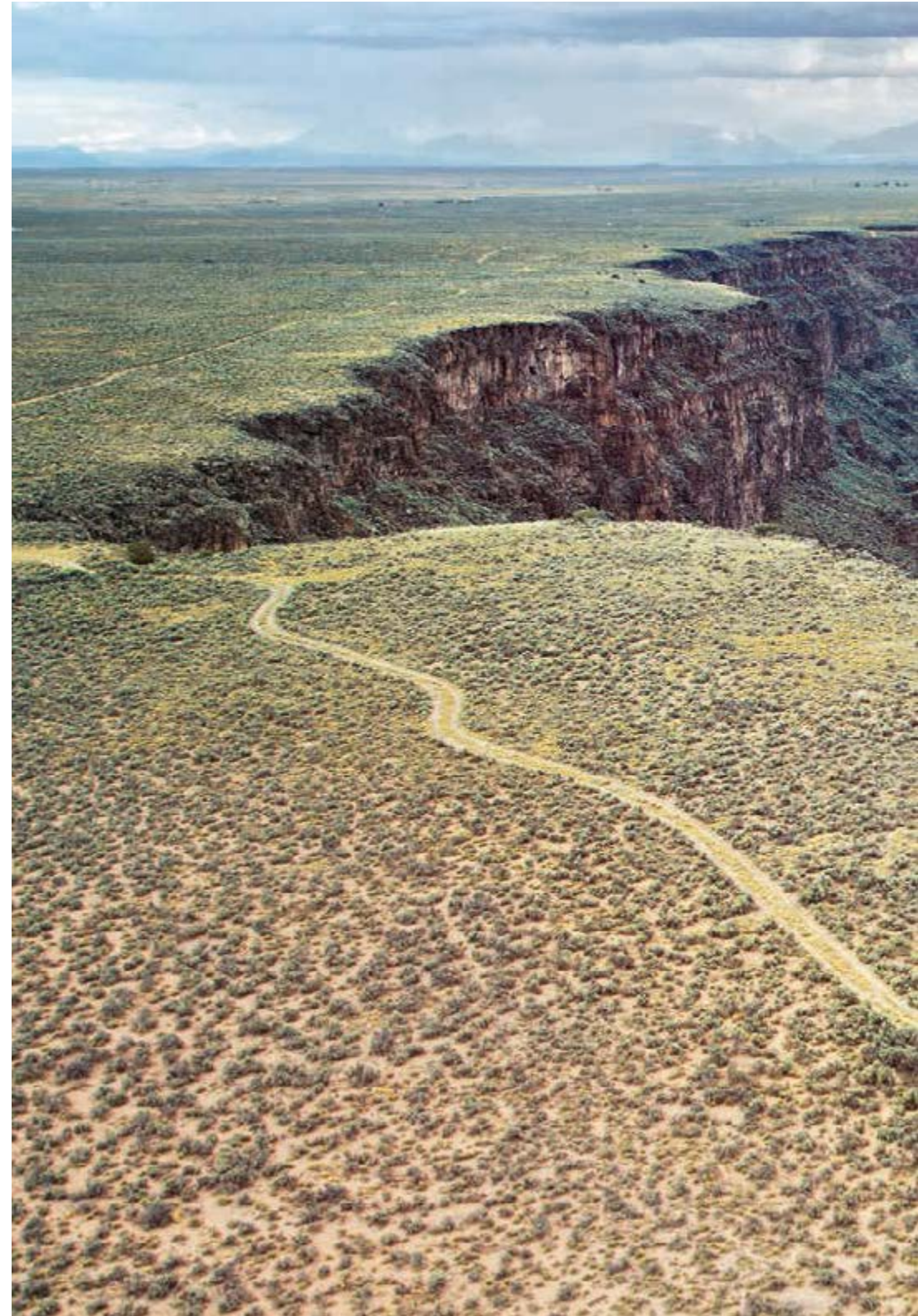



ABOVE & BEYOND

CONTENTS

SPECIFICATION

LOCATE A RETAILER

BUILD YOUR OWN





ABOVE & BEYOND

CONTENTS

SPECIFICATION

LOCATE A RETAILER

BUILD YOUR OWN

IT HAS 'DRIVE ME'
WRITTEN ALL OVER IT.

Gerry McGovern.
Land Rover Design Director and Chief Creative Officer.



Scan to view the Range Rover Sport in action.

Vehicle shown right is Supercharged with Dynamic Package in Indus Silver.





ABOVE & BEYOND

CONTENTS

SPECIFICATION

LOCATE A RETAILER

BUILD YOUR OWN



CONTENTS

DESIGN

Exterior	6
Interior	9
5 + 2 Seating	10
Cargo Capacity	12
SVR	15

DRIVING TECHNOLOGY

Testing	18
Terrain Response®	20
All Terrain Progress Control (ATPC)	20
Low Traction Launch	20
Electronic Air Suspension	20
Hill Descent Control (HDC®)	23
Dynamic Response	24
Torque Vectoring	24
Adaptive Dynamics	27
Dynamic Stability Control	27
SVR Dynamic Response	28

DRIVER ASSISTANCE

Driving Aids	31
Parking Aids	33
Towing Aids	35

CONNECTIVITY.

ENTERTAINMENT. COMFORT

Land Rover InControl®	36
Meridian™ Sound System	40
Comfort For All	43

ENGINES

8-speed Automatic Transmission	47
Diesel Engine	47
Gasoline Engines	48

BODY AND CHASSIS

All-Aluminum Body	50
-------------------	----

SAFETY

Enhanced Driver and Passenger Protection	52
--	----

ENVIRONMENTAL

Sustainability	55
----------------	----

SPECIFICATIONS

Choose Your Engine	58
Choose Your Model and Options	60
Choose Your Color	82
Choose Your Wheels	90
Choose Your Interior	92
Choose Your Accessories	102

TECHNICAL DETAILS

	108
--	-----

A WORLD OF LAND ROVER

	110
--	-----



ABOVE & BEYOND

CONTENTS

SPECIFICATION

LOCATE A RETAILER

BUILD YOUR OWN

DESIGN

EXTERIOR

Born from a relentless drive to create a contemporary yet authentic design, its distinctive silhouette, streamlined front elevation and rearward sloping roof give the vehicle immense road presence.

With seductive flowing lines and stylish features such as the side vent and grille, the sophisticated design of the vehicle is conveyed without compromising its character.

It is beautifully proportioned with a muscular and contemporary look. The tapered bodywork and wide track help give the vehicle a powerful, planted stance.

While the gentle curves, signature headlights and sculpted corners denote the precision of its design that is unmistakably Land Rover.



Vehicle shown above and right is Supercharged with Dynamic Package in Indus Silver with optional wheel.





ABOVE & BEYOND

CONTENTS

SPECIFICATION

LOCATE A RETAILER

BUILD YOUR OWN



DESIGN 7

DESIGN

DRIVING
TECHNOLOGY

FINISHING TOUCHES

ENGINES

BODY AND CHASSIS

SAFETY

ENVIRONMENTAL





ABOVE & BEYOND

CONTENTS

SPECIFICATION

LOCATE A RETAILER

BUILD YOUR OWN



DESIGN

DRIVING
TECHNOLOGY

FINISHING TOUCHES

ENGINES

BODY AND CHASSIS

SAFETY

ENVIRONMENTAL





ABOVE & BEYOND

CONTENTS

SPECIFICATION

LOCATE A RETAILER

BUILD YOUR OWN

INTERIOR

Contemporary. Beautifully designed. Flawlessly executed.

The Range Rover Sport interior is meticulously appointed to reflect its character. Superb detailing, strong elegant lines and clean surfaces combined with luxurious soft touch finishes. Intuitively placed controls, such as the CommandShift® 2, create a cabin that places the driver at its center.

The centerpiece of the interior is the bold intersection between the strong horizontal elements of the instrument panel and the vertical lines of the center console. The dynamic character of the cockpit is complemented by the angle of the center console, with its striking Satin Chrome pillars which flow from the instrument panel through into the rear cabin.

The finest materials and a keen eye for detail helped to shape this comfortable yet purposeful space. The strong architectural lines of the interior are balanced by soft lighting and the choice of color themes available. The use of leather and metal truly complements the sporty design.

The 10" screen* with its 21:9 wide format is a superb addition to the vehicle's contemporary, clean interior.



*Driving while distracted can result in loss of vehicle control. Do not operate, adjust or view the navigation or multimedia systems under conditions that will affect your safety or the safety of others. Only use mobile phones and other devices, even with voice commands, when it is safe to do so.

Interiors shown are HSE in Ebony/Ivory with Ivory seats and Grand Black veneer.



ABOVE & BEYOND

CONTENTS

SPECIFICATION

LOCATE A RETAILER

BUILD YOUR OWN

5+2 SEATING

For additional seating versatility, the optional 5 + 2 arrangement* has two seats stored under the floor of the luggage compartment, which are split 50/50, with no loss of cargo space. They have been designed for occasional use, enabling the vehicle to accommodate up to seven occupants.

The second row seats have forwards / backwards movement of four inches allowing for better access to the third row seats and flexible accommodation. Power operation is standard for the third row seats. When folded, the third row seats leave a flat floor in the luggage compartment.



*The third row seats are suitable for use by older children who can either use the adult belt or a booster seat in conjunction with the adult belt. They are not suitable for smaller children who require a child seat where the adult belt is not used directly to restrain the child. When the vehicle is equipped with a third row seat, a tire repair kit is included, and no spare tire is available.

Features and their availability may differ by vehicle specification. Please see pages 66-81, or contact your nearest Land Rover Retailer, for more information. Availability varies by engine. Please see page 75 for more information. Interior shown is Autobiography with Dynamic Package in Espresso/Ivory/Tan, with Espresso/Ivory/Tan seats and Shadow Zebrano veneer with optional features fitted.



ABOVE & BEYOND

CONTENTS

SPECIFICATION

LOCATE A RETAILER

BUILD YOUR OWN



DESIGN

DRIVING
TECHNOLOGY

FINISHING TOUCHES

ENGINES

BODY AND CHASSIS

SAFETY

ENVIRONMENTAL





ABOVE & BEYOND

CONTENTS

SPECIFICATION

LOCATE A RETAILER

BUILD YOUR OWN



CARGO SPACE CAPACITY

Whether you're heading out to the opera for the evening or for a week of skiing, Range Rover Sport has ample cargo space. In fact, there are 27.7 cu.ft available or, when the rear seats are stored flat, 62.2 cu.ft.

Even though the vehicle enjoys the most exemplary levels of refinement, it's always ready to accommodate your luggage or even bulkier loads with ease.

5 + 2 SEATS



ABOVE & BEYOND

CONTENTS

SPECIFICATION

LOCATE A RETAILER

BUILD YOUR OWN



5 SEATS



4 SEATS



3 SEATS



2 SEATS



ABOVE & BEYOND

CONTENTS

SPECIFICATION

LOCATE A RETAILER

BUILD YOUR OWN



DESIGN

DRIVING
TECHNOLOGY

FINISHING TOUCHES

ENGINES

BODY AND CHASSIS

SAFETY

ENVIRONMENTAL





ABOVE & BEYOND

CONTENTS

SPECIFICATION

LOCATE A RETAILER

BUILD YOUR OWN



RANGE ROVER SPORT SVR IS A NATURAL PROGRESSION BEYOND THE CORE VEHICLE'S OUTSTANDING ON AND OFF-ROAD CAPABILITIES AND LEADING-EDGE DESIGN. IT IS TRULY ONE OF THE WORLD'S MOST CAPABLE PERFORMANCE SUV'S.

John Edwards.
Managing Director of Special Vehicle Operations.

SVR

EXTERIOR

Designed and Engineered by Special Vehicle Operations (SVO) – Land Rover's center of excellence for bespoke commissions, luxury editions and performance models – Range Rover Sport SVR builds on the marque's capabilities and creates a performance SUV that is even more exhilarating.

This is immediately apparent in the SVR design, with the vehicle's muscular, broad shouldered stance being the perfect complement to its performance and handling. Large air intakes in the front bumper increase airflow to the two charge air coolers while the rear spoiler increases down-force at high speeds.



Vehicle shown left is SVR in Estoril Blue with optional Narvik Black contrast roof.



ABOVE & BEYOND

CONTENTS

SPECIFICATION

LOCATE A RETAILER

BUILD YOUR OWN



INTERIOR

The stylish cabin has been ergonomically designed around the driver. The 14-way SVR Sports powered front seats – with memory and SVR embossing on the seat – are in the softest perforated Oxford leather.

A choice of four color themes enables you to personalize the space to your taste. Added to which, deft touches such as optional Carbon Fiber trim contribute greatly to the look.

Range Rover Sport SVR. Sit behind the wheel and you will know why it takes the performance SUV to its most rounded, electrifying and compelling level yet.

16 Interiors shown above and right are SVR in Ebony/Cirrus with optional features fitted.

DESIGN

DRIVING TECHNOLOGY

FINISHING TOUCHES

ENGINES

BODY AND CHASSIS

SAFETY

ENVIRONMENTAL



ABOVE & BEYOND

CONTENTS

SPECIFICATION

LOCATE A RETAILER

BUILD YOUR OWN



DESIGN

DRIVING
TECHNOLOGY

FINISHING TOUCHES

ENGINES

BODY AND CHASSIS

SAFETY

ENVIRONMENTAL





ABOVE & BEYOND

CONTENTS

SPECIFICATION

LOCATE A RETAILER

BUILD YOUR OWN

DRIVING TECHNOLOGY

TESTING

Before any vehicle can carry the Land Rover badge, rigorous testing has been carried out to establish the highest levels of luxury, performance and capability.



SUSPENSION

You're unlikely to push any Land Rover harder than we have. To guarantee an unrivalled breadth of dynamic capability, both on and off-road, the vehicles have been exposed to some of the most extreme driving pressures in a fraction of the time using our test rig.



WIND SPEED

In our climate chambers we can recreate some of the most challenging wind conditions Range Rover Sport will face. Not just 112mph crosswinds, but high ambient temperatures and low airflow situations. Only by pushing all systems to their limits do we develop true excellence.



HOT AND COLD CLIMATE

In real world environments and our climate chambers, we freeze vehicles to -40°F and bake them to 120°F. Key functions and systems are then scrutinized to our exacting standards. So even on the most remote locations, comfort and peace of mind are never far away.



OFF-ROAD

From the icy proving grounds of Arjeplog, Sweden, to Dubai's unforgiving desert sands, we ensure our legendary all-terrain performance is innate in every vehicle. Prototypes are tested on approximately 5,300 miles of the most demanding off-road routes.



SEMI-ANECHOIC CHAMBER

In the 'neutral sound' of our semi-anechoic chamber we precisely expose the cabin to a range of frequencies and vibrations, making certain that Range Rover Sport sounds refined at every speed and across every surface.



MONSOON

Using our monsoon simulator, we drench our vehicles with nearly 19,000 gallons of specially dyed water, while tilting it by as much as 45°, checking for even the slightest leak with UV lights. Ensuring each vehicle can enter and exit a body of water and stay dry inside the cabin.



ABOVE & BEYOND

CONTENTS

SPECIFICATION

LOCATE A RETAILER

BUILD YOUR OWN



Professional driver on closed course. Do not attempt.

DRIVING TECHNOLOGY 19

DESIGN

DRIVING
TECHNOLOGY

FINISHING TOUCHES

ENGINES

BODY AND CHASSIS

SAFETY

ENVIRONMENTAL





ABOVE & BEYOND

CONTENTS

SPECIFICATION

LOCATE A RETAILER

BUILD YOUR OWN

TERRAIN RESPONSE®

With over 65 years of all-terrain expertise, the Range Rover Sport has Land Rover capability at its heart. Our unique 4-mode Terrain Response® system enables the driver to optimize the vehicle's engine, transmission, center differential and chassis systems to match the demands of the terrain, by selecting one of the easily identifiable driving modes*.

The optional Terrain Response® 2 system enhances this by monitoring driving conditions and automatically selecting the driving modes to achieve the best possible chassis and powertrain set up for the conditions. It also includes additional Rock Crawl Mode*.

An optional sixth setting is available when Terrain Response® 2 with Dynamic Mode is specified. Dynamic Mode tunes the suspension to deliver tighter body control with flatter handling and sharper responses*.



ALL TERRAIN PROGRESS CONTROL

All Terrain Progress Control (ATPC) is an optional system that is designed to help drivers set and maintain a steady speed in challenging conditions*.

Operating like a cruise control system, it functions at very low speeds between 1mph and 18mph, enabling the driver to maintain full concentration on steering and finding a path through obstacles*.

Developed by Land Rover's all-terrain specialists, the system works seamlessly alongside the Terrain Response® 2 and Four Wheel Drive (4WD) traction and braking systems*.

Once ATPC is activated, the standard steering wheel +/- cruise control buttons are used to set the speed. Brake and accelerator pedals can still override the chosen settings, with gentle braking achieving a reduction in speed.

LOW TRACTION LAUNCH

Range Rover Sport features a dedicated launch function which can assist the vehicle to pull away smoothly and easily, even on tricky low-friction surfaces like snow or wet grass.

ELECTRONIC AIR SUSPENSION

Range Rover Sport features an electronic air suspension system which delivers comfort and capabilities both on and off-road.

The system automatically switches between two ride heights when the off-road setting is selected. Maximum ground clearance is increased by 2.6 inches above normal ride height at speeds less than 31mph.

The suspension system delivers impressive wheel travel with 10.2 inches of movement at the front and 10.7 inches at the rear, providing exceptional wheel articulation and composure to deal with the tough conditions.



*These systems are not a substitute for driving safely with due care and attention and will not function under all circumstances, speeds, weather and road conditions, etc. Driver should not assume that these systems will correct errors of judgment in driving. Please consult the owner's manual or your local authorized Land Rover Retailer for more details. Features and their availability may differ by vehicle specification. Please see pages 66-81, or contact your nearest Land Rover Retailer, for more information.





ABOVE & BEYOND

CONTENTS

SPECIFICATION

LOCATE A RETAILER

BUILD YOUR OWN



DESIGN

DRIVING
TECHNOLOGY

FINISHING TOUCHES

ENGINES

BODY AND CHASSIS

SAFETY

ENVIRONMENTAL





ABOVE & BEYOND

CONTENTS

SPECIFICATION

LOCATE A RETAILER

BUILD YOUR OWN



	DESIGN	DRIVING TECHNOLOGY	FINISHING TOUCHES	ENGINES	BODY AND CHASSIS	SAFETY	ENVIRONMENTAL	
--	--------	--------------------	-------------------	---------	------------------	--------	---------------	--



ABOVE & BEYOND

CONTENTS

SPECIFICATION

LOCATE A RETAILER

BUILD YOUR OWN



HILL DESCENT CONTROL (HDC®)

To complement the **Terrain Response®** system*, Range Rover Sport can also call upon a unique suite of all-terrain technologies to help improve performance.

Hill Descent Control (HDC®) assists with controlled descent of difficult slopes by maintaining a constant speed and applying braking separately to each wheel*.

Hill Start Assist is designed to prevent the vehicle from rolling backwards as you pull away on an incline.

The vehicle also utilizes **Gradient Release Control (GRC)** which is designed to prevent the vehicle from 'running away' on a steep incline when the driver releases the brake*.

*These systems are not a substitute for driving safely with due care and attention and will not function under all circumstances, speeds, weather and road conditions, etc. Driver should not assume that these systems will correct errors of judgment in driving. Please consult the owner's manual or your local authorized Land Rover Retailer for more details.

Vehicle shown left is Autobiography with Dynamic Package in Corris Grey with optional wheel and Narvik Black contrast roof.





ABOVE & BEYOND

CONTENTS

SPECIFICATION

LOCATE A RETAILER

BUILD YOUR OWN

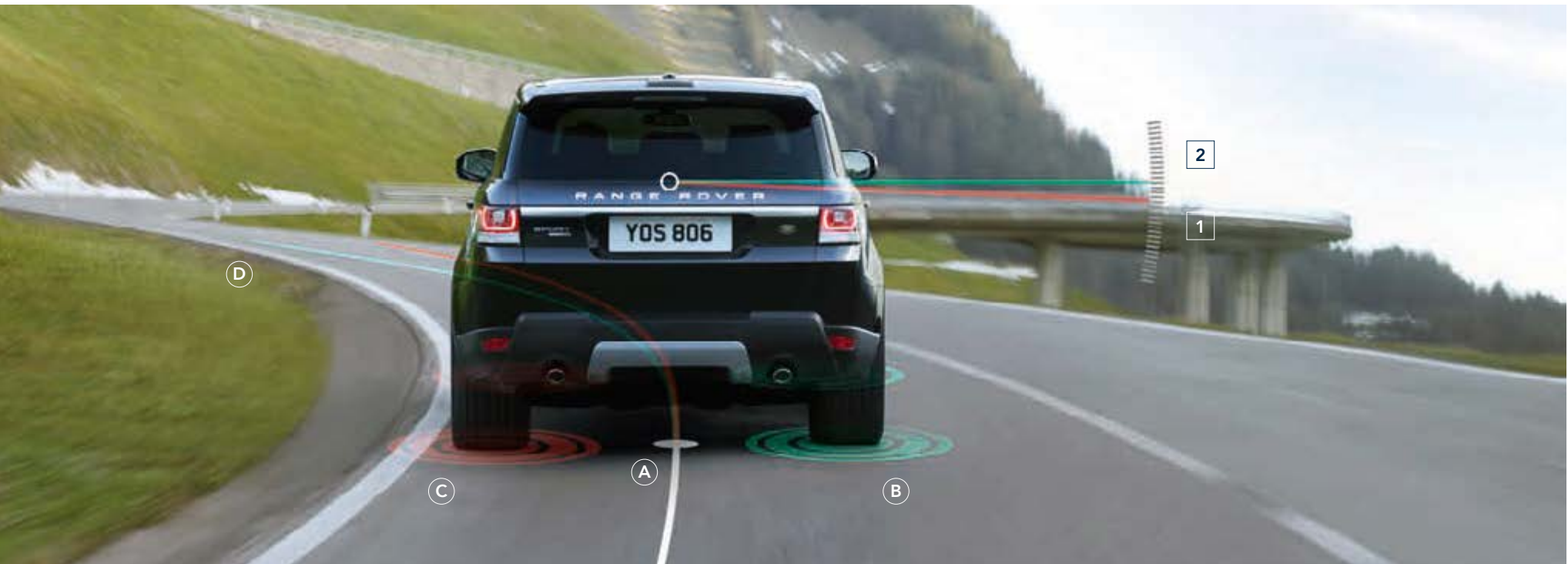

DYNAMIC RESPONSE*

Dynamic Response is designed to improve vehicle handling through hydraulic roll control, optimizing on-road performance and passenger comfort, by reducing the amount of body lean during cornering.

Our two-channel system is capable of controlling the front and rear axles independently, allowing it to be tuned to deliver increased low-speed agility, along with enhanced high-speed stability and greater steering precision.

This feature also aids off-road capability. If the system detects off-road conditions, the control module reduces the level of lean compensation and actively manages the body roll rate, allowing improved passenger comfort and body composure at low speeds.

- 1** UNADJUSTED LATERAL BODY LEAN
- 2** CORRECTED LATERAL BODY LEAN

TORQUE VECTORING*

The Torque Vectoring by Braking system* with dynamic active rear locking differential delivers responsive, controlled cornering and handling through even the tightest of bends. The electronic differential and vehicle's brake system constantly balance the distribution of engine torque between the four wheels when cornering. Exceptional grip and steering confirm Range Rover Sport as our most dynamic SUV.

The system is also active in off-road conditions using the relevant Terrain Response settings. It can be very effective in conditions such as sand, where it helps the vehicle turn in and avoid excessive understeer.

- A** UNDERSTEER DETECTED
- B** FULL TORQUE TO OUTER WHEELS
- C** BRAKING FORCE TO INNER WHEELS
- D** LINE CORRECTED

*These systems are not a substitute for driving safely with due care and attention and will not function under all circumstances, speeds, weather and road conditions, etc. Driver should not assume that these systems will correct errors of judgment in driving. Please consult the owner's manual or your local authorized Land Rover Retailer for more details. Features and their availability may differ by vehicle specification. Please see pages 66-81, or contact your nearest Land Rover Retailer, for more information.

Vehicle shown above and right is HSE in Farallon Black.



ABOVE & BEYOND

CONTENTS

SPECIFICATION

LOCATE A RETAILER

BUILD YOUR OWN



DESIGN

DRIVING
TECHNOLOGY

FINISHING TOUCHES

ENGINES

BODY AND CHASSIS

SAFETY

ENVIRONMENTAL





ABOVE & BEYOND

CONTENTS

SPECIFICATION

LOCATE A RETAILER

BUILD YOUR OWN



DESIGN

DRIVING
TECHNOLOGY

FINISHING TOUCHES

ENGINES

BODY AND CHASSIS

SAFETY

ENVIRONMENTAL





ABOVE & BEYOND

CONTENTS

SPECIFICATION

LOCATE A RETAILER

BUILD YOUR OWN



ADAPTIVE DYNAMICS

Featuring continuously variable dampers, Adaptive Dynamics* provides the optimum balance of ride and control by offering infinitely variable damper settings between soft and firm extremes.

The system monitors vehicle movements up to 500 times per second, reacting to driver or road inputs virtually instantaneously to give great control and minimize body movement, providing a composed ride. The system is designed to sense off-road conditions, and to improve damping accordingly.

DYNAMIC STABILITY CONTROL

Stay composed when cornering as Dynamic Stability Control* detects deviation from your chosen course and applies appropriate braking.

The system monitors the vehicle 100 times per second via the Dynamic Stability Control module. As the vehicle accelerates through a corner, the system uses yaw sensors to detect the beginning of understeer.

Imperceptible levels of braking are then used to correct the vehicle attitude, while engine torque is transferred to the outside wheels, which have more grip, thus maintaining traction and steering control.

*These systems are not a substitute for driving safely with due care and attention and will not function under all circumstances, speeds, weather and road conditions, etc. Driver should not assume that these systems will correct errors of judgment in driving. Please consult the owner's manual or your local authorized Land Rover Retailer for more details. Features and their availability may differ by vehicle specification. Please see pages 66-81, or contact your nearest Land Rover Retailer, for more information.

Vehicle shown left is HSE in Farallon Black with optional wheel.



ABOVE & BEYOND

CONTENTS

SPECIFICATION

LOCATE A RETAILER

BUILD YOUR OWN

SVR DYNAMIC RESPONSE

Working with the vehicle's upgraded air springs and Adaptive Dynamics continuously variable dampers, the two-channel Dynamic Response* is specially tuned to enhance the high-performance capability of the Range Rover Sport SVR.

Indeed, the SVR is so much more competent on asphalt that Land Rover had to completely re-scale existing Dynamic Response parameters to take account of its increased cornering ability, allowing the Range Rover Sport SVR to corner flatter and faster than any other Land Rover in history.

The system is also tuned to deliver progressive traction at the limit, particularly when the optional 22" tires reach their grip threshold. This helps the vehicle remain predictable up to the tires' limits while cornering.

While Dynamic Response is tuned to behave uniquely for the Range Rover Sport SVR during performance driving, it automatically reverts to the same software map as other Range Rover Sport models once off-road use is detected by sensors monitoring body movement, wheel positions and vehicle height. This greatly reduces body lean at speeds up to 25mph and maintains excellent off-road capability.



*These systems are not a substitute for driving safely with due care and attention and will not function under all circumstances, speeds, weather and road conditions, etc. Driver should not assume that these systems will correct errors of judgment in driving. Please consult the owner's manual or your local authorized Land Rover Retailer for more details. Vehicle shown above and right is SVR in Estoril Blue with optional Narvik Black contrast roof and optional wheel.





ABOVE & BEYOND

CONTENTS

SPECIFICATION

LOCATE A RETAILER

BUILD YOUR OWN



DESIGN

DRIVING TECHNOLOGY

FINISHING TOUCHES

ENGINES

BODY AND CHASSIS

SAFETY

ENVIRONMENTAL





ABOVE & BEYOND

CONTENTS

SPECIFICATION

LOCATE A RETAILER

BUILD YOUR OWN

DRIVER ASSISTANCE

DRIVING AIDS



DESIGN

DRIVING
TECHNOLOGY

FINISHING TOUCHES

ENGINES

BODY AND CHASSIS

SAFETY

ENVIRONMENTAL





ABOVE & BEYOND

CONTENTS

SPECIFICATION

LOCATE A RETAILER

BUILD YOUR OWN

SPORTS COMMAND DRIVING POSITION

The Range Rover Sport provides drivers with a Sports Command Driving Position* by elevating the driver within the vehicle, delivering a supreme sense of confidence and control with a sporting, less upright seating position.

This offers a reassuring view of the vehicle and its surroundings, with clear visibility to the side and outstanding forward visibility over the characteristic profile of the hood; all of which contribute to the unique Range Rover Sport character.

TRAFFIC SIGN RECOGNITION WITH INTELLIGENT SPEED LIMITER

Traffic Sign Recognition keeps you fully informed by displaying particular traffic signs in the instrument cluster where they can easily be seen, and as part of Head-up Display when fitted. The system is capable of detecting variable speed limits and where it exists, navigation data is used to increase its effectiveness*.

When activated, Intelligent Speed Limiter uses Traffic Sign Recognition information to adjust your vehicle's speed accordingly*.

FULL THIN FILM TRANSISTOR (TFT) VIRTUAL INSTRUMENT PANEL

The available 12.3" virtual instrument panel uses high-resolution display technology and color graphics for clear communication of the main vehicle functions and data. With elegant virtual dials resembling 3D Chrome it can be tailored to display only information that is relevant to the current driving situation.

HEAD-UP DISPLAY

Head-up Display*† is an option that presents key vehicle data such as speed, gear selection and navigation directions on the windshield, without distraction or the need for you to take your eyes off the road.

The innovative laser system is robust against issues such as 'washout' – the effect that the glare from sunlight may have on it. The system is fully configurable and can be customized to your specific tastes. The feature can be turned on or off dependent on driver preference.



*These systems are not a substitute for driving safely with due care and attention and will not function under all circumstances, speeds, weather and road conditions, etc. Driver should not assume that these systems will correct errors of judgment in driving. Please consult the owner's manual or your local authorized Land Rover Retailer for more details †Requires solar attenuating windshield or privacy glass with solar attenuating windshield.

Vehicle shown left is Supercharged with Dynamic Package in Indus Silver with optional wheel.



ABOVE & BEYOND

CONTENTS

SPECIFICATION

LOCATE A RETAILER

BUILD YOUR OWN

DRIVING AIDS

Range Rover Sport has a wealth of innovative and seamlessly integrated Driver Assistance features. Each one is designed to make every journey or maneuver simpler.



LANE KEEP ASSIST AND DRIVER CONDITION MONITOR*

Lane Keep Assist is designed to detect when your vehicle is unintentionally drifting out of your lane, and to gently steer you back. Driver Condition Monitor is designed to detect if you're starting to feel drowsy and gives you an early warning when you need to take a break.



ADAPTIVE CRUISE CONTROL WITH QUEUE ASSIST AND INTELLIGENT EMERGENCY BRAKING*

When you're cruising on the highway or travelling in slow-moving traffic, this system is designed to keep your vehicle a pre-set distance from the one in front should it slow or stop. When the vehicle speeds up again so does Range Rover Sport. If a collision is unavoidable, Adaptive Cruise Control is designed to engage Intelligent Emergency Braking. This system is designed to help reduce the severity of the possible impact by automatically applying the brakes.



AUTONOMOUS EMERGENCY BRAKING*

Functioning at moderate speeds, if a potential collision is detected, this system displays a forward collision warning, giving you time to take action. If a collision is still anticipated and you have taken no action, this system is designed to apply the brakes to help reduce the severity of the possible impact.



BLIND SPOT MONITOR WITH REVERSE TRAFFIC DETECTION*

Blind Spot Monitor is designed to alert you to vehicles in, or quickly approaching, your blind spot, through a small warning light in the corresponding door mirror. Reverse Traffic Detection warns you of hazards approaching from either side of your vehicle, through both audible and visual warnings so you know what's behind you even when the view is obstructed. Optional Blind Spot Assist with Reverse Traffic Detection is also available.

*These systems are not a substitute for driving safely with due care and attention and will not function under all circumstances, speeds, weather and road conditions, etc. Driver should not assume that these systems will correct errors of judgment in driving. Features and their availability may differ by vehicle specification. Please see pages 78-79 or contact your nearest Land Rover Retailer, for more information.



ABOVE & BEYOND

CONTENTS

SPECIFICATION

LOCATE A RETAILER

BUILD YOUR OWN

PARKING AIDS

Parking your vehicle in a busy town or city is not always a simple and straightforward maneuver, which is why Range Rover Sport features an array of aids to help you reverse and park, even when you're negotiating the tightest of spaces.

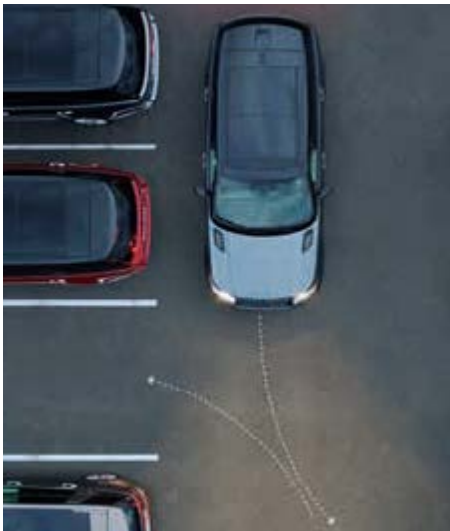

PARK ASSIST – PARALLEL PARK, PARKING EXIT AND PERPENDICULAR PARK*

Our Park Assist system makes parallel and perpendicular parking easier than ever by steering your vehicle into a suitable space. You just have to select the appropriate gear and control the vehicle's speed. Park Assist will also steer you out of a space, taking the stress out of parking. Graphics and notifications guide you through the maneuvers.



SURROUND CAMERA SYSTEM*

Giving a 360° exterior view via the Touchscreen, this helps with various maneuvers from parking by a curb to getting in and out of tight spaces and intersections.



REAR VIEW CAMERA*

To make parking in tight spots simpler, lines to represent the vehicle's outer perimeter and predicted path are superimposed on the rearward image displayed on your Touchscreen.

Features and their availability may differ by vehicle specification. Please see pages 78-79 or contact your nearest Land Rover Retailer, for more information.

DRIVER ASSISTANCE 33

DESIGN

DRIVING TECHNOLOGY

FINISHING TOUCHES

ENGINES

BODY AND CHASSIS

SAFETY

ENVIRONMENTAL



ABOVE & BEYOND

CONTENTS

SPECIFICATION

LOCATE A RETAILER

BUILD YOUR OWN

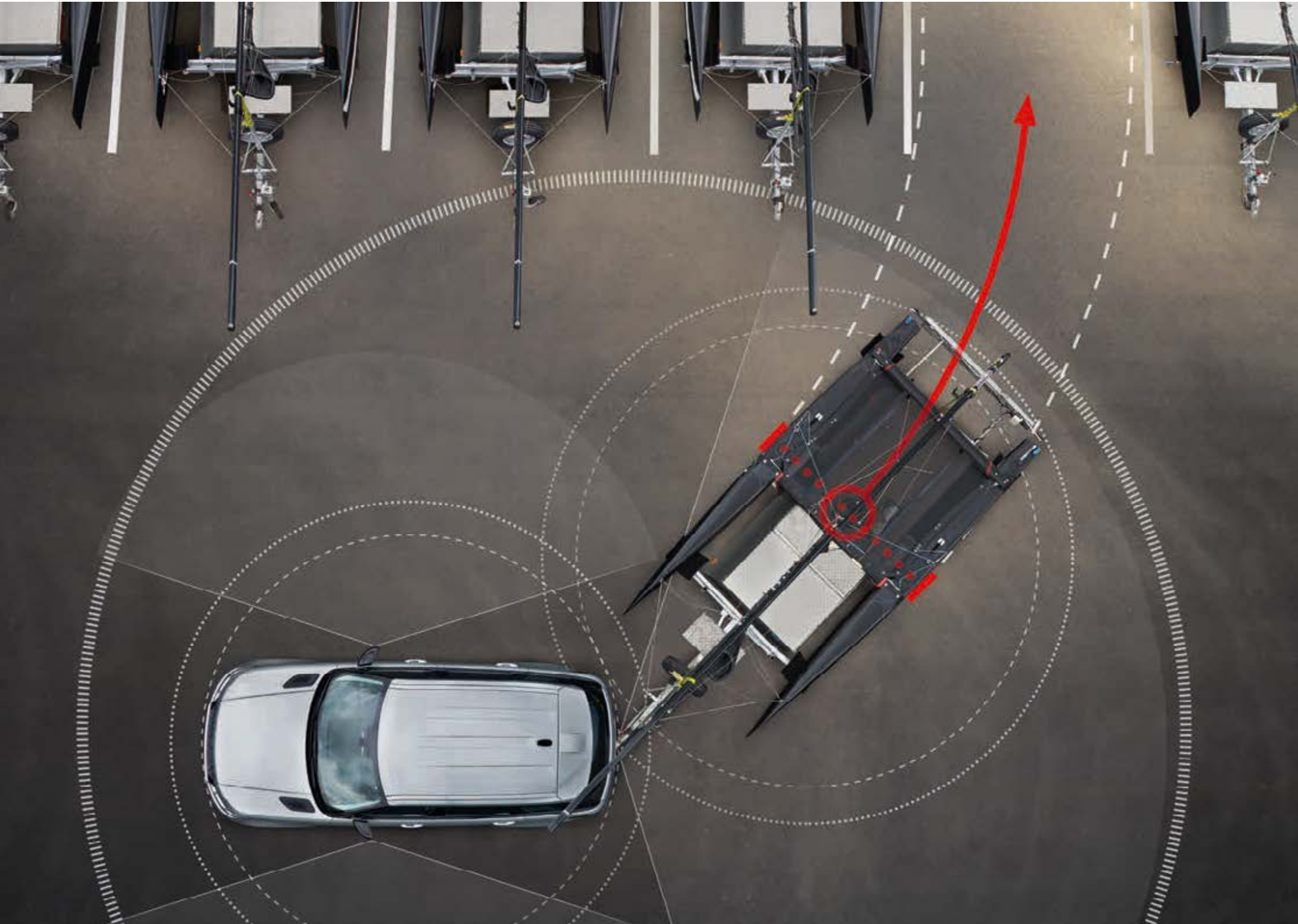

DESIGN

DRIVING
TECHNOLOGY

FINISHING TOUCHES

ENGINES

BODY AND CHASSIS

SAFETY

ENVIRONMENTAL





ABOVE & BEYOND

CONTENTS

SPECIFICATION

LOCATE A RETAILER

BUILD YOUR OWN



TOWING AIDS

With a towing capacity of up to 7,716lbs* and by incorporating tailored technologies, Range Rover Sport can handle the most demanding of tasks.

TOW HITCH ASSIST

Tow Hitch Assist** makes coupling a trailer to the vehicle much easier by helping you visualize the hitching process**; it displays the predicted path of the vehicle tow ball towards the trailer tow bar on the Touchscreen**. Standard with Rear View Camera.

TOW ASSIST

On the road, the Tow Assist feature helps with reversing by predicting the trailer's direction. You can even choose your trailer's width for precise guidelines displayed on the Touchscreen. Standard with Surround Camera System.

ADVANCED TOW ASSIST**

Advanced Tow Assist** allows you to control the direction of your trailer when reversing by using the rotary Terrain Response® 2 controller. This optional system will control the vehicle's steering to achieve the desired trailer trajectory. The Touchscreen will display the current and desired trailer trajectory.

TRAILER STABILITY ASSIST**

Trailer Stability Assist (TSA) monitors the vehicle to detect movements in the trailer and then uses selective braking to help correct potentially hazardous situations.

SURROUND CAMERA SYSTEM**

For a complete, all-round view, the optional Surround Camera System** incorporating T-Intersection View helps to see everything clearly on the high-resolution full color Touchscreen. Using four digital cameras discreetly placed around the vehicle, the system provides an almost complete 360° view including a birds-eye overhead view. It aids parking and is perfect for more complex driving assignments such as towing a sailboat or horse trailer.

Along with the ability to display several different views at the same time, this technology can also zoom and pan, ensuring objects and angles, normally below the line of sight, can be seen.

*6,613lbs limit on SVR model **These systems are not a substitute for driving safely with due care and attention and will not function under all circumstances, speeds, weather and road conditions, etc. Driver should not assume that these systems will correct errors of judgment in driving.

Vehicle shown left is Supercharged with Dynamic Package in Indus Silver.

Vehicle shown above is an accessorised Autobiography with Dynamic Package and Bright Package in Corris Grey. Accessories shown include Noble Plated mirror caps, Stainless Steel front undershield, side protection tubes and 21" 9 spoke 'Style 901' wheel with Satin Black finish.



ABOVE & BEYOND

CONTENTS

SPECIFICATION

LOCATE A RETAILER

BUILD YOUR OWN

CONNECTIVITY. ENTERTAINMENT. COMFORT

LAND ROVER INCONTROL®



InControl is our suite of advanced technologies that links both you and your Range Rover Sport to the wider world*.

*Do not use Land Rover InControl® features under conditions that will affect your safety or the safety of others. Driving while distracted can result in loss of vehicle control. Certain features require a Micro SIM with a suitable data contract which will require further subscription after the initial term advised by your Retailer. Apple Watch is a registered trademark of Apple Inc., registered in the US and other countries. InControl® Apps will need to be downloaded from the Apple/Android Store, please contact your nearest Land Rover Retailer for further information.

Find out more about Land Rover InControl® at landroverusa.com

DESIGN

DRIVING TECHNOLOGY

FINISHING TOUCHES

ENGINES

BODY AND CHASSIS

SAFETY

ENVIRONMENTAL





ABOVE & BEYOND

CONTENTS

SPECIFICATION

LOCATE A RETAILER

BUILD YOUR OWN

INCONTROL TOUCH PRO™



INCONTROL TOUCH PRO

The next-generation hardware and software advances the Range Rover Sport connectivity and entertainment to the very highest level*. Some key aspects of InControl Touch Pro are:

- 10" Touchscreen
- InControl Touch Pro Navigation
- Range Rover Audio System 250W with 8 speakers
- InControl Apps – features a range of Land Rover approved apps that can be connected to Range Rover Sport from your smartphone. It optimizes and enhances your in-car experience*
- InControl Protect which includes SOS Emergency Call, Land Rover Optimized Assistance and Remote Essentials smartphone app
- Sirius XM® Satellite Radio† & HD Radio™.



AVAILABLE

- 12.3" Instrument Panel Display with virtual dials and full screen 3D Map View
- Rear Seat Entertainment (not available on SVR models)
- Meridian™ Surround Sound System 825W with 18 speakers and subwoofer
- Meridian™ Reference Sound System 1700W with 22 speakers and subwoofer and Conversation Assist.



INCONTROL PRO SERVICES

You have the option of adding these services, technologies and applications to give you the very best in connectivity and convenience*. It offers features including:

- InControl Apps*
- Remote Premium – includes Remote Start Climate Control, Remote Lock and Unlock, and Remote Beep and Flash
- Includes InControl Wi-Fi™ Hotspot**, Route Planner App, Live Services, Commute Mode, Arrival Mode and Arrival Mode Parking.

*A 3-month trial subscription to the Sirius All Access package is included with the vehicle, which gives you access to 150+ channels of premium programming. Plus you can stream SiriusXM on your computer, smartphone or tablet – it's included in your trial. If you decide to continue service after your trial, the subscription plan you choose will automatically renew thereafter and you will be charged according to your chosen payment method at then-current rates. Fees and taxes apply. To cancel you must call SiriusXM at 1-866-635-2349. See the SiriusXM Customer Agreement for complete terms at siriusxm.com. All fees and programming are subject to change. SiriusXM Satellite Radio is not available in Alaska or Hawaii **The Wi-Fi Hotspot is intended for passenger use only. InControl features may require an additional subscription with separate terms and conditions.

Please refer to the standard and optional feature listing on pages 66-81.

Certain features require a Micro SIM with a suitable data contract which will require further subscription after the initial term advised by your Retailer. iPhone® is a registered trademark of Apple Inc., registered in the US and other countries. Mobile network connectivity cannot be guaranteed in all locations.

Vehicle shown left is Supercharged with Dynamic Package in Indus Silver with optional wheel.



ABOVE & BEYOND

CONTENTS

SPECIFICATION

LOCATE A RETAILER

BUILD YOUR OWN

9 WAYS TO GET YOUR LIFE CONNECTED

Find out how InControl can make your life easier*.

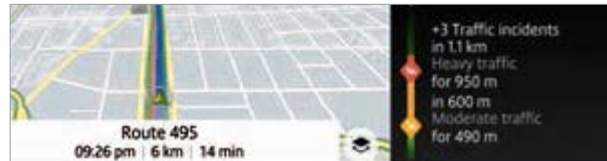

PLANNING ROUTES

Before setting off, use the **Route Planner App** or online portal to search, save locations or set your destination. The app uses the Cloud to send your destination automatically to your vehicle's navigation screen*.

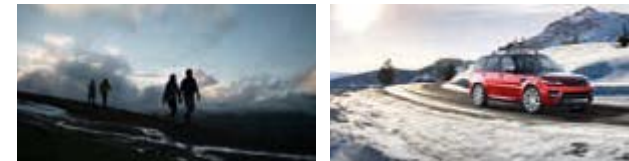

STAYING CONNECTED

Before you get into your vehicle, set your ideal cabin temperature with the **Remote Premium App** on smartphones and now the Apple Watch®. On the road, the in-car **Wi-Fi Hotspot** provides a stable Internet connection and lets you connect up to eight devices**.



STAYING FOCUSED

Our all-new InControl Touch Pro **Voice Recognition** system understands normal spoken instructions. So you can concentrate on the road ahead without distractions*.



FINDING PARKING

When you near your destination, **InControl Touch Pro Navigation** will suggest nearby parking from a database including space availability. With just one click, parking is added and your route is updated. **Arrival Mode Parking** shows a 360° street level image to help you identify your destination.

*Do not use Land Rover InControl® features under conditions that will affect your safety or the safety of others. Driving while distracted can result in loss of vehicle control **The Wi-Fi Hotspot is intended for passenger use only. InControl features may require an additional subscription. Certain features require the fitment of Pro Services and a Micro SIM with a suitable data contract which will require further subscription after the initial term advised by your Retailer. Apple Watch® is a registered trademark of Apple Inc., registered in the US and other countries. Mobile network connectivity cannot be guaranteed in all locations. InControl apps will need to be downloaded from the Apple/Android Store, please contact your nearest Land Rover Retailer for further information.



ABOVE & BEYOND

CONTENTS

SPECIFICATION

LOCATE A RETAILER

BUILD YOUR OWN

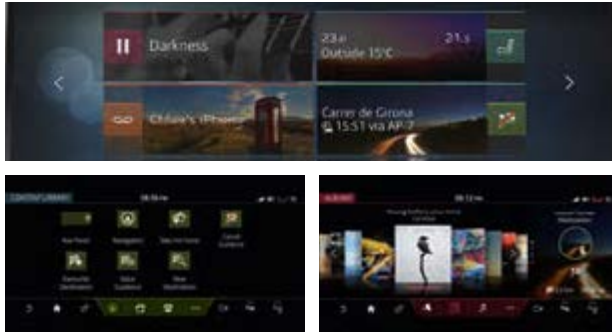

MOVING FASTER

InControl Touch Pro brings you more processing power, thanks to a quad core processor, plus integrated Ethernet network*.

Customizable homescreens let you arrange the screen, as you like, with up to four personalized homescreens and over 60 shortcuts.



INTELLIGENT ROUTING

Commute Mode allows the system to learn your commutes and automatically advises you of the expected journey time based on live and historical traffic movements without having to input a destination. The system learns the routes you take for a given destination and then advises which of those is the quickest.

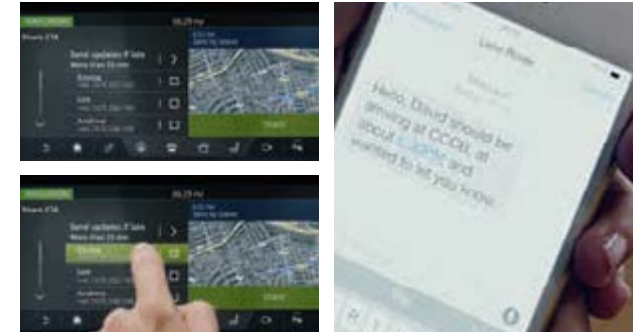

SHARING PROGRESS

Share your estimated time of arrival so your selected contact(s) will know exactly when you will arrive, as calculated by the navigation guidance system. If you're running late, Share ETA can then send automatic updates via text or email, without any further action from you*.



DOOR-TO-DOOR

Once you've parked, the Route Planner App will guide you to your destination – a true door-to-door experience which includes public transportation options. The Remote Premium App also lets you check your vehicle to make sure you've locked and secured all doors and windows.



HELP IS ALWAYS AT HAND

With InControl Protect the emergency services will be automatically notified if the airbags deploy, or you can call them manually via an in-car button. You can also call a Land Rover Optimized Assistance operator should you need technical assistance.



ABOVE & BEYOND

CONTENTS

SPECIFICATION

LOCATE A RETAILER

BUILD YOUR OWN



MERIDIAN™ SOUND SYSTEMS

Meridian products offer the very best in British engineering, technology and design. Just like Land Rover, it is an intuitive and personal experience. Meridian sound masters have employed years of psychoacoustic research to enable you to experience music in a new dimension.

MERIDIAN REFERENCE SOUND SYSTEM (1700W)*

The optional 1700 Watt system has 22 speakers and 22 channels, and a dual channel subwoofer, with four speakers located in the roof lining delivering a realistic musical performance. While all sound systems offer highly optimized sound quality, the 1700 Watt system incorporates Meridian Trifield* 3D technology, which provides greater control over the content of the surround and side channels, as well as additional signal feeds for height speakers.

This innovative technology expands the sense of space within the cabin, providing a personal, realistic three-dimensional listening experience in every seat. Your entertainment system comes with Conversation Assist, a feature that aids normal conversation between everyone in the vehicle, by a microphone that is linked from the rear seats to speakers in the front.

MERIDIAN SURROUND SOUND SYSTEM (825W)

The 825 Watt system has 18 speakers and 16 channels, and a dual channel subwoofer, which are placed in ideal positions around the vehicle. This available system also incorporates Meridian Trifield* technology to create a concert-like experience for all occupants.

Meridian is a trademark of Meridian Audio Limited.

*Trifield and the "three fields" device is a trademark of Trifield Productions Ltd.

Features and their availability may differ by vehicle specification.

Please see pages 68-85, or contact your nearest Land Rover Retailer, for more information.

Vehicle shown right is Autobiography with Dynamic Package and Bright Package in Corris Grey.



ABOVE & BEYOND

CONTENTS

SPECIFICATION

LOCATE A RETAILER

BUILD YOUR OWN



MERIDIAN REFERENCE SOUND SYSTEM

1700 WATTS

22 SPEAKERS

SUBWOOFER

CONNECTIVITY. ENTERTAINMENT. COMFORT 41

DESIGN

DRIVING TECHNOLOGY

FINISHING TOUCHES

ENGINES

BODY AND CHASSIS

SAFETY

ENVIRONMENTAL



ABOVE & BEYOND

CONTENTS

SPECIFICATION

LOCATE A RETAILER

BUILD YOUR OWN



DESIGN

DRIVING
TECHNOLOGY

FINISHING TOUCHES

ENGINES

BODY AND CHASSIS

SAFETY

ENVIRONMENTAL





ABOVE & BEYOND

CONTENTS

SPECIFICATION

LOCATE A RETAILER

BUILD YOUR OWN



COMFORT FOR ALL



CLIMATE CONTROL

To ensure that the interior is maintained at the perfect temperature whatever the weather outside, Range Rover Sport features a Climate Control system which features the latest technology. The result of an incredibly rigorous development program, the system has been tested in real-world conditions in temperatures ranging from -40 to 120°F.

Three versions are available: the standard two-zone system, a three-zone system, or the premium four-zone system with separate climate controls for driver, front passenger and each side of the rear cabin.

With its independent heating and cooling capability in the rear compartment, the four-zone system offers an exceptional level of comfort in the rear seats, with multiple outlets at face, foot and hip level.

CONFIGURABLE INTERIOR MOOD LIGHTING

Passengers can change the interior lighting to suit their tastes. There are ten colors in total ranging from Spark Blue through to Ice White and Racing Red. Simply operated variable brightness controls can help create the desired mood. The clean, elegant lines and premium materials of the interior are complemented by carefully detailed LED mood lighting that brings the cabin alive at night. Available as an optional feature.

PANORAMIC ROOF

Flooding the interior with light, the available fixed or sliding panoramic roof enhances the feeling of space and a connection to the world outside. Yet, at the touch of a button, the driver and passengers can feel cocooned once more as the full-length power blind glides into place.

Interior shown left is HSE in Ebony/Ivory with Ivory seats with optional features fitted.

CONNECTIVITY. ENTERTAINMENT. COMFORT 43

DESIGN

DRIVING TECHNOLOGY

FINISHING TOUCHES

ENGINES

BODY AND CHASSIS

SAFETY

ENVIRONMENTAL



ABOVE & BEYOND

CONTENTS

SPECIFICATION

LOCATE A RETAILER

BUILD YOUR OWN



COMFORT FOR ALL

POWERED GESTURE TAILGATE

This feature adds practicality and makes life with your Range Rover Sport even easier. Electronically operated, simply by performing a smooth upward movement of the foot beneath the sensor, powered gesture tailgate enables the driver to operate the tailgate (both to open and close) from the curb without needing to physically touch either the vehicle or the key fob, provided the smart key is detected.

SOFT DOOR CLOSE

For additional convenience, Range Rover Sport is available with power latching on all doors. This allows the last 0.25 inches of the travel of the doors to be controlled and provides a soft close of the front and rear doors.

REAR SEAT ENTERTAINMENT

The optional Rear Seat Entertainment System provides either 8" screens built in to the headrest or 10" high-definition seat mounted articulating screens. It includes 'Journey Status', a Navigation Summary screen which displays a pop-up for the rear occupant detailing the time and distance to destination. Both systems come with a pair of WhiteFire® digital wireless headphones and HDMI, Mobile High-Definition Link and USB connections.

AUTOMATIC ACCESS HEIGHT

Attention to detail is everywhere you look and in everything you touch. For instance, the Automatic Access Height feature lowers the vehicle with precision by up to 2 inches, for easier entry and exit when parked. Arriving in style at any function has never been more relaxed.

WhiteFire® is a registered trademark of Unwired Technology LLC and any use of such marks by Land Rover is under licence. Features and their availability may differ by vehicle specification. Please see pages 66-81, or contact your nearest Land Rover Retailer, for more information. Interior shown right is HSE in Ebony/Ivory with Ivory seats with optional features fitted. Vehicle shown left is Supercharged with Dynamic Package in Indus Silver and optional wheel.



ABOVE & BEYOND

CONTENTS

SPECIFICATION

LOCATE A RETAILER

BUILD YOUR OWN



DESIGN

DRIVING
TECHNOLOGY

FINISHING TOUCHES

ENGINES

BODY AND CHASSIS

SAFETY

ENVIRONMENTAL





ABOVE & BEYOND

CONTENTS

SPECIFICATION

LOCATE A RETAILER

BUILD YOUR OWN





ABOVE & BEYOND

CONTENTS

SPECIFICATION

LOCATE A RETAILER

BUILD YOUR OWN

ENGINES

8-SPEED AUTOMATIC TRANSMISSION

All engines in the Range Rover Sport are paired with the advanced electronically controlled ZF 8-speed automatic transmission, which has been tuned to combine silky-smooth shifting with exceptionally rapid response.

With eight closely spaced ratios, gear changes are almost imperceptible, with each shift completed in just 200 milliseconds.

Controls include the optional steering wheel-mounted Paddle Shift and the standard CommandShift 2, enabling the driver to take control of gear shifting manually.

The transmission accepts multiple downshifts, maintaining a smooth transition between ratios, with quicker shifts and sportier kick-downs in Dynamic Mode.

The optimized lightweight 8-speed transmission is the perfect partner to the torque-rich gas and diesel engines.

The transmission is tuned to select torque converter lock-up as early as possible to reduce slip and energy loss. **Transmission Idle Control** disengages 70 percent of the drive when the vehicle is stationary and the engine is idling in Drive, helping to reduce fuel consumption in urban conditions.

In cold conditions, the transmission selects a lower gear to promote fast warm up and get the engine up to its efficient operating temperature as soon as possible.

DIESEL ENGINE

254HP Td6

The Td6 engine delivers exceptional performance. It achieves 0-60 mph in 7.1 seconds* with 443 lbs-ft of torque.



ACCELERATION 0-60MPH*
(SECONDS)

TOP SPEED
(MPH)*

254HP Td6 Turbocharged 3.0L Diesel

7.1

130

*Always follow local speed limits.

ENGINES 47

DESIGN

DRIVING
TECHNOLOGY

FINISHING TOUCHES

ENGINES

BODY AND CHASSIS

SAFETY

ENVIRONMENTAL



ABOVE & BEYOND

CONTENTS

SPECIFICATION

LOCATE A RETAILER

BUILD YOUR OWN

GASOLINE ENGINES

340HP SUPERCHARGED V6

A Roots-type twin vortex supercharger is mounted in the 'V' between the two rows of cylinders for compact dimensions. Supercharging provides linear delivery of power and improves responsiveness. The engine also features dual independent variable cam timing to vary inlet and exhaust valve operation, working alongside lightweight pistons with ultra-low friction piston rings, for increased performance and efficiency. For added refinement there is a twin, counter-rotating balancer shaft system.

380HP SUPERCHARGED V6

The powerful 380HP Supercharged V6 delivers an additional 40HP and can accelerate from 0-60 mph in 6.8 seconds*.

510HP SUPERCHARGED V8

5.0L V8 Supercharged delivers exhilarating performance with a 0-60 mph in just 5.0 seconds** on a power output of 510HP and 461 lb-ft of torque, all achieved with supreme refinement.

The V8 has a compact and lightweight all-aluminum design, with extremely low levels of internal friction. The engine is optimized around a Bosch engine management system. This features high-pressure direct injection with centrally mounted, multi-hole, spray guided injection system.

The 510HP engine is fitted with a sixth generation, Twin Vortex System (TVS) supercharger that offers thermodynamic efficiency and refined noise levels.

550HP SUPERCHARGED V8

Range Rover Sport SVR goes from 0-60 mph in 4.5 seconds*. It has a top speed of 162 mph. Its 5.0 liter Supercharged V8 engine delivers 550HP and 502 lb-ft.

This breath-taking performance is enabled by a recalibration of the engine and its management system to increase maximum available boost pressure. Maximum torque is delivered at 3,500-4,000rpm.



	ACCELERATION 0-60MPH* (SECONDS)	TOP SPEED (MPH)*
340HP Supercharged 3.0L V6	6.9	130
380HP Supercharged 3.0L V6	6.8	130
510HP Supercharged 5.0L V8	5.0	130/140**
550HP Supercharged 5.0L V8	4.5	162

*Always follow local speed limits **140 with Dynamic Package.



ABOVE & BEYOND

CONTENTS

SPECIFICATION

LOCATE A RETAILER

BUILD YOUR OWN



ENGINES 49

DESIGN

DRIVING
TECHNOLOGY

FINISHING TOUCHES

ENGINES

BODY AND CHASSIS

SAFETY

ENVIRONMENTAL



ABOVE & BEYOND

CONTENTS

SPECIFICATION

LOCATE A RETAILER

BUILD YOUR OWN

BODY AND CHASSIS

ALL-ALUMINUM BODY

The all-aluminum unibody makes the vehicle strong, efficient and sustainable. Being lighter also improves both speed and agility for a refined driving experience.

The body has been engineered to withstand the same off-road use as all Land Rover vehicles. This structure means that traditional energy intensive construction methods, such as spot welding, are not required.

To create such a weight-efficient body, the structure features a rigorously optimized combination of stamped, cast and extruded aluminum alloy components, so that the strength of the bodyshell is concentrated precisely where the loads are greatest.

This results in a structure which delivers outstanding stiffness and refinement optimized crash performance.

This structure is supported by a lightweight front and rear suspension designed to deliver a much broader range of dynamic capabilities across all terrains.

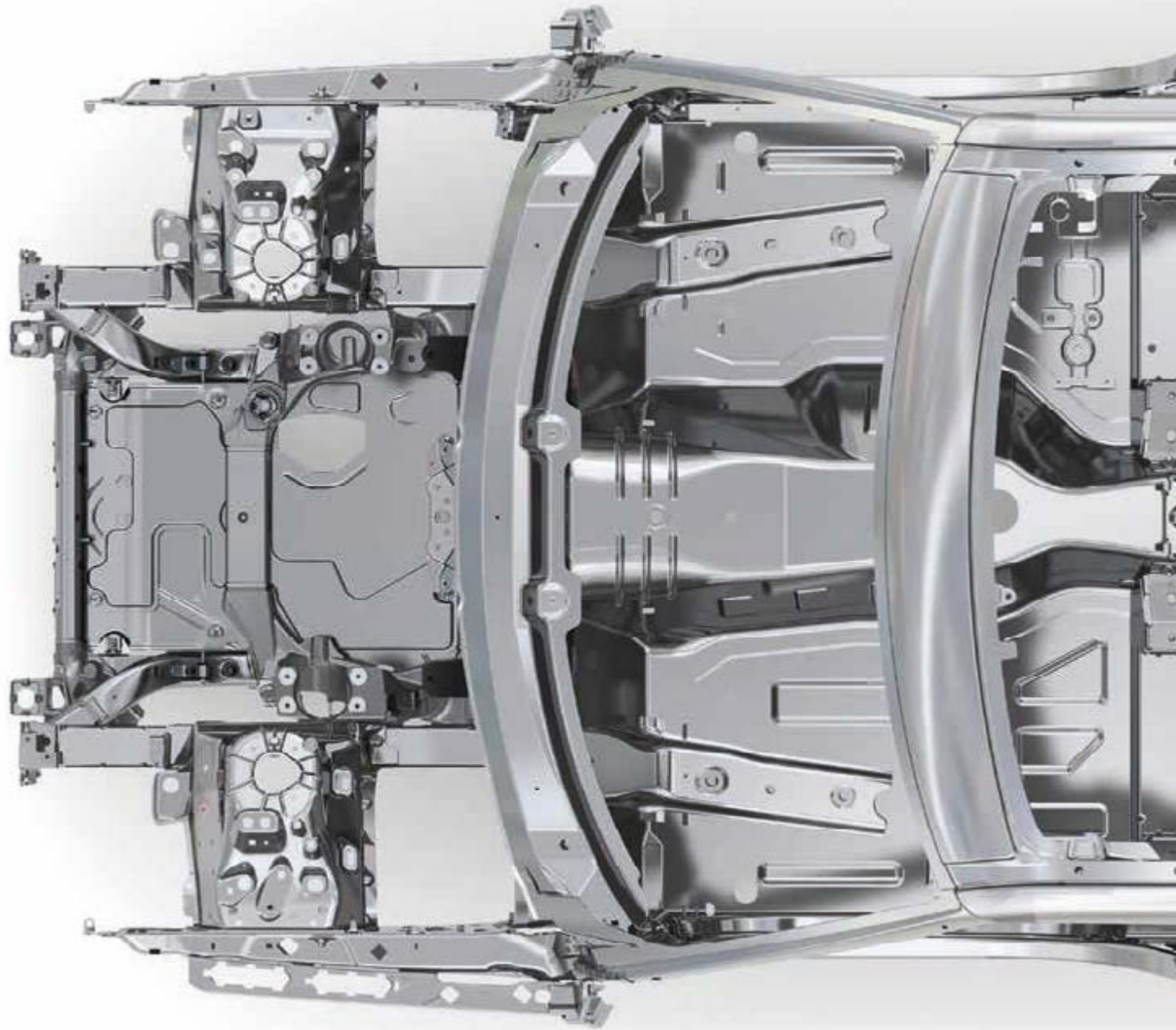



ABOVE & BEYOND

CONTENTS

SPECIFICATION

LOCATE A RETAILER

BUILD YOUR OWN



SUSPENSION

Primarily constructed from aluminum components, the suspension is fully independent, with a wide-spaced double-wishbone design at the front and an advanced multi-link layout at the rear.

The suspension was specifically developed to maximize breadth of capability, offering responsive and agile handling together with supreme ride quality and refinement.

SVR

The Range Rover Sport has high levels of comfort and extremely agile handling. The SVR takes that capability to the next level. The vehicle's chassis is tuned to provide quicker responses, tighter body control, higher cornering velocities and an increased sense of connection to the road.





ABOVE & BEYOND

CONTENTS

SPECIFICATION

LOCATE A RETAILER

BUILD YOUR OWN

SAFETY

ENHANCED DRIVER AND PASSENGER PROTECTION

The optimized aluminum body structure protects occupants by using an incredibly strong and stable safety cell. This crash structure is optimized using computer simulation tools, which allows engineers to conduct a significant number of 'virtual' crash tests long before physical prototypes are available.

The occupant safety package includes a comprehensive system of airbags and restraint systems including driver and passenger airbags, side curtain and thorax airbags and seat belt pretensioners* which are linked to the vehicle's emergency braking functions.

PASSENGER SEAT BELT CHECK SYSTEM



CURTAIN AIRBAG WITH ROLLOVER SENSING*

In the event of a side impact or rollover, these are deployed to provide greater protection against head injuries.

SEAT BELT PRETENSIONERS**

Provide additional protection in the event of a front impact by reducing the forward movement of the occupant.

DRIVER AND PASSENGER AIRBAGS*

The airbags have two levels of inflation to ensure they inflate to the optimum level depending on the incident to provide maximum occupant protection.

*Please remember that the safety belts in a vehicle constitute the primary protection system for driver and passengers in collisions. Airbags are not designed to deploy in all collisions. The airbag Supplemental Restraint System (SRS) is a supplement to the safety belts and is designed to work as a system with the safety belts. Although airbags provide additional protection, airbags without safety belts do not provide optimal protection in a crash. Always wear your safety belts. Children younger than 13 years old should always be properly restrained in a back seat, away from airbags. Never place an infant seat in the front seat **Front, outer second row and third row seats only.





ABOVE & BEYOND

CONTENTS

SPECIFICATION

LOCATE A RETAILER

BUILD YOUR OWN

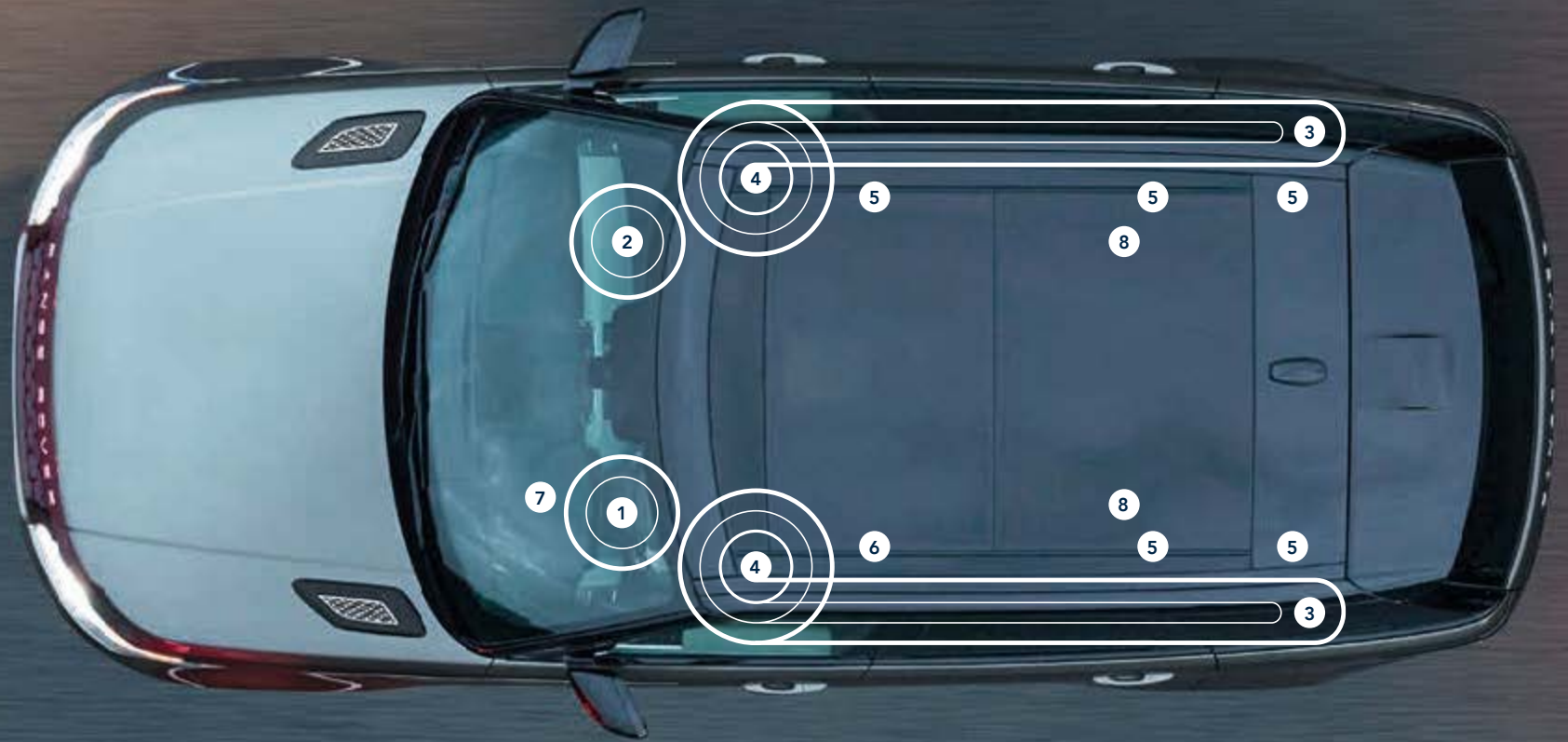

SAFETY SYSTEMS

- 1 DRIVER AIRBAG
- 2 PASSENGER AIRBAG
- 3 SIDE CURTAIN AIRBAGS

- 4 SIDE THORAX AIRBAGS
- 5 SEAT BELT PRETENSIONERS
- 6 DOUBLE SEAT BELT PRETENSIONER

- 7 SEAT BELT REMINDER
- 8 LATCH CHILD SEAT RESTRAINT SYSTEM





ABOVE & BEYOND

CONTENTS

SPECIFICATION

LOCATE A RETAILER

BUILD YOUR OWN



DESIGN

DRIVING
TECHNOLOGY

FINISHING TOUCHES

ENGINES

BODY AND CHASSIS

SAFETY

ENVIRONMENTAL





ABOVE & BEYOND

CONTENTS

SPECIFICATION

LOCATE A RETAILER

BUILD YOUR OWN



ENVIRONMENTAL

SUSTAINABILITY

EFFICIENCY DRIVES SUSTAINABILITY

Range Rover Sport demonstrates Land Rover's commitment to enhancing the sustainability of its products and operations. With its aluminum structure and optimized powertrains, Range Rover Sport addresses the growing consumer need for more environmentally responsible vehicles in a carbon-conscious world.

Its greener credentials stem from a comprehensive approach to reducing environmental impact throughout the life cycle of the vehicle, from development and manufacturing, to customer use and end-of-life.

SUSTAINABLE BY DESIGN, WITH A LIFE CYCLE APPROACH

In order to minimize the vehicle's overall ecological impact, Range Rover Sport is designed with a life cycle approach, aiming to minimize the environmental impact by considering the entire life cycle of the vehicle.

Each element of the life cycle was analyzed with a view to consuming fewer natural resources, using more sustainable materials and minimizing the generation of waste.

The development process has included a full life cycle assessment in line with ISO 14040/14044.

The aluminum construction makes a major contribution to its reduced carbon footprint. Up to 50 percent of the aluminum material is sourced from recycled content, resulting in a significant saving of energy and CO₂ emissions.

Recycled and renewable materials are used wherever possible in the Range Rover Sport. High specification vehicles use up to 59 lbs of recycled plastics, diverting over 15,796 tons of plastic from landfill during the carline's life. Natural and renewable materials, such as the luxurious leathers and veneers, represent 62 lbs of each vehicle.

INTELLIGENT STOP START SYSTEM

All Range Rover Sport powertrains incorporate low CO₂ technologies such as the advanced Intelligent Stop/Start System. The system automatically shuts down the engine at rest and starts it again as soon as you lift your foot off the brake. It features a **Tandem Solenoid Starter** with a dedicated secondary battery for instant restarting.

Vehicle shown left is Autobiography with Dynamic Package in Corris Grey with optional wheel and optional unpainted brake calipers.





ABOVE & BEYOND

CONTENTS

SPECIFICATION

LOCATE A RETAILER

BUILD YOUR OWN

RANGE ROVER SPORT OFFERS GREAT OPTIONS AND FLEXIBILITY TO PERSONALIZE YOUR VEHICLE.

The following pages take you through a logical series of steps to make your vehicle suit your lifestyle. There are several choices: from selecting your engine and model to exterior and interior colors, wheels, finishes and those detailed touches to enable you to personalize your vehicle.

If you'd like to bring your options to life, go to our online configurator at landroverusa.com

58-59

1

**STEP 1
CHOOSE YOUR ENGINE**

You can select from a range of powerful gasoline or diesel engines.

60-81

2

**STEP 2
CHOOSE YOUR MODEL
AND OPTIONS**

Compare the standard and optional features on each model.



ABOVE & BEYOND

CONTENTS

SPECIFICATION

LOCATE A RETAILER

BUILD YOUR OWN

82-89

3

**STEP 3
CHOOSE YOUR COLOR**

There's a wide range of colors to enable you to express yourself.

90-91

4

**STEP 4
CHOOSE YOUR WHEELS**

There's a range of styles, each one designed to complement the bold exterior.

92-101

5

**STEP 5
CHOOSE YOUR INTERIOR**

Carefully selected colors complemented by a range of finishes. You can personalize your interior space.

102-107

6

**STEP 6
CHOOSE YOUR ACCESSORIES**

This range of stylish and practical accessories can be tailored to suit any lifestyle.

108-109

TECHNICAL DETAILS

Technical information and data for dimensions, performance and specifications.

Visit landroverusa.com to configure your vehicle online. 57

ENGINE

MODEL

COLOUR

WHEELS

INTERIOR

ACCESSORIES

TECHNICAL DETAILS



ABOVE & BEYOND

CONTENTS

SPECIFICATION

LOCATE A RETAILER

BUILD YOUR OWN

1



58



ENGINE

MODEL

COLOUR

WHEELS

INTERIOR

ACCESSORIES

TECHNICAL DETAILS





ABOVE & BEYOND

CONTENTS

SPECIFICATION

LOCATE A RETAILER

BUILD YOUR OWN

**STEP 1
CHOOSE YOUR ENGINE**

DRIVELINE, ENGINE PERFORMANCE AND FUEL ECONOMY

	DIESEL		GASOLINE		
	3.0L TURBOCHARGED DIESEL V6	3.0L SUPERCHARGED V6	3.0L SUPERCHARGED V6	5.0L SUPERCHARGED V8	5.0L SUPERCHARGED V8 SVR
	AUTOMATIC	AUTOMATIC	AUTOMATIC	AUTOMATIC	AUTOMATIC
POWER (HP)	254	340	380	510	550
Driveline	4 Wheel Drive (4WD)	4 Wheel Drive (4WD)	4 Wheel Drive (4WD)	4 Wheel Drive (4WD)	4 Wheel Drive (4WD)
Maximum power (hp @ rpm)	254 @ 3,750	340 @ 6,500	380 @ 6,500	510 @ 6,000-6,500	550 @ 6,000-6,500
Maximum torque (lb-ft @ rpm)	443 @ 1,750-2,250	332 @ 3,500-5,000	332 @ 3,500-5,000	461 @ 2,500-5,500	502 @ 3,500-4,000
Capacity (cc)	2,993	2,995	2,995	4,999.7	4,999.7
No. of cylinders	6	6	6	8	8
Valves per cylinder	4	4	4	4	4
Cylinder layout	Longitudinal V6	Longitudinal V6	Longitudinal V6	Longitudinal V8	Longitudinal V8

MODELS BY ENGINE

	SE	HSE	HSE DYNAMIC	SUPERCHARGED	SUPERCHARGED WITH DYNAMIC PACKAGE	AUTOBIOGRAPHY	SVR
254HP Turbocharged Diesel 3.0L V6	■	■					
340HP Supercharged 3.0L V6	■	■					
380HP Supercharged 3.0L V6			■				
510HP Supercharged 5.0L V8				■	■	■	
550HP Supercharged 5.0L V8							■

FUEL ECONOMY

Please visit landroverusa.com for the most up-to-date fuel economy figures.

Vehicle shown left is HSE in Firenze Red with optional features fitted.

Visit landroverusa.com to configure your vehicle online. 59

ENGINE

MODEL

COLOUR

WHEELS

INTERIOR

ACCESSORIES

TECHNICAL DETAILS



ABOVE & BEYOND

CONTENTS

SPECIFICATION

LOCATE A RETAILER

BUILD YOUR OWN

2

EACH MODEL HAS A CHOICE OF ENGINES AND UNIQUE FEATURES.

Each model has a choice of engines and unique features. This guide will help you to select your ideal Range Rover Sport. On the following pages you will see the standard features for each model.

RANGE ROVER SPORT SE



- Grille in Dark Atlas with Gloss Black surround
- Fender vent with Dark Atlas fingers, Satin Black mesh and surrounds
- Body-colored upper mirror caps
- Atlas Silver RANGE ROVER script on hood and tailgate
- Body-colored roof
- Tow eye covers in Dark Techno Silver
- Grained leather
- 19" 5-split spoke 'Style 501' alloy wheels
- Leather steering wheel
- Two-zone Climate Control
- Gesture tailgate.

60 Vehicles shown include optional wheels. Please refer to pages 90-91 for wheel availability.

ENGINE

MODEL

COLOUR

WHEELS

INTERIOR

ACCESSORIES

TECHNICAL DETAILS



ABOVE & BEYOND

CONTENTS

SPECIFICATION

LOCATE A RETAILER

BUILD YOUR OWN

STEP 2 CHOOSE YOUR MODEL AND OPTIONS

RANGE ROVER SPORT HSE



- Sliding panoramic roof
- Front fog lights
- Heated front and rear seats
- Aluminum front treadplates with Range Rover script
- Garage door opener
- Grille in Atlas with Gloss Black surround

- Fender vent with Atlas Silver fingers, Atlas Silver mesh and Gloss Black surround
- Fog light surrounds in Atlas Silver
- Tow eye covers in Indus Silver
- Seats in perforated Oxford leather
- 20" 5 split-spoke 'Style 520' alloy wheels.

RANGE ROVER SPORT HSE DYNAMIC



- Auto-dimming exterior mirrors
- Narvik Black contrast roof*
- Body-colored side sills and bumpers
- Driver condition monitor
- Blind Spot Monitoring with Reverse Traffic Detection
- Intelligent Speed Limiter and Traffic Sign Recognition

- Seats in perforated Oxford leather
- Climate front seats with heated rear seats
- Heated leather steering wheel
- Three-zone Climate Control
- 21" 5 split-spoke 'Style 507' alloy wheels with Satin Grey finish.

Visit landroverusa.com to configure your vehicle online. 61

ENGINE

MODEL

COLOUR

WHEELS

INTERIOR

ACCESSORIES

TECHNICAL DETAILS



ABOVE & BEYOND

CONTENTS

SPECIFICATION

LOCATE A RETAILER

BUILD YOUR OWN

RANGE ROVER SPORT SUPERCHARGED



- Two-speed transfer case*
- Terrain Response® 2*
- All Terrain Progress Control*
- Adaptive Dynamics
- Torque Vectoring
- Red Brembo™ branded brake calipers
- Paddle shift.
- Sliding panoramic roof
- 20" 5 split-spoke 'Style 520' alloy wheels.

RANGE ROVER SPORT SUPERCHARGED DYNAMIC PACKAGE



- Red SPORT badge
- Bright sport pedal
- Grille in Gloss Black painted mesh with Gloss Black surround
- Gloss Black fender vents and fingers
- Narvik Black mirror caps
- Gloss Black hood vents and mesh
- Gloss Black hood and tailgate script
- Fog light blades in Gloss Black
- Gloss Black tailgate finisher
- Tow eye covers in Corris Grey
- 21" 5 split-spoke 'Style 507' alloy wheels with Satin Grey finish.

*Standard with V8 Supercharged 510HP engine **Standard with 550HP Supercharged V8 engine. Brembo is a registered trademark of Freni Brembo S.p.A



ABOVE & BEYOND

CONTENTS

SPECIFICATION

LOCATE A RETAILER

BUILD YOUR OWN

STEP 2 CHOOSE YOUR MODEL AND OPTIONS

RANGE ROVER SPORT AUTOBIOGRAPHY



- Noble plated paddle shift
- Two-speed transfer case
- Terrain Response® 2
- Adaptive Dynamics
- Red brake calipers
- Sliding panoramic roof
- Auto High Beam Assist (AHBA)

- Contrast roof - Narvik Black
- 21" 5 split spoke 'Style 507' with Diamond Turned finish alloy wheels
- Perforated Oxford leather with Autobiography pattern
- Climate front seats with heated rear seats.

RANGE ROVER SPORT SVR



- Darkened headlights with Gloss Black finish to non-reflective surfaces
- SVR rear spoiler
- Bright quad tailpipes
- Unique grille in Gloss Black painted mesh with Gloss Black surround
- Distinct design of fender vents in Gloss Black

- Lower front bumper grille insert and splitter in Gloss Black (splitter is Corris Grey when exterior color is Fuji White, Yulong White or Indus Silver)
- Unique design of front and rear bumpers
- Sport seats in perforated Oxford leather with SVR pattern
- 21" 5 split-spoke 'Style 517' alloy wheels*
- Blue Brembo™ branded brake calipers.

*Wheels shown are optional.

Visit landroverusa.com to configure your vehicle online. 63

ENGINE

MODEL

COLOUR

WHEELS

INTERIOR

ACCESSORIES

TECHNICAL DETAILS



ABOVE & BEYOND

CONTENTS

SPECIFICATION

LOCATE A RETAILER

BUILD YOUR OWN



ENGINE

MODEL

COLOUR

WHEELS

INTERIOR

ACCESSORIES

TECHNICAL DETAILS



ABOVE & BEYOND

CONTENTS

SPECIFICATION

LOCATE A RETAILER

BUILD YOUR OWN

STEP 2
CHOOSE YOUR MODEL AND OPTIONS

PERSONALIZING THE EXTERIOR

STEALTH DESIGN PACKAGE FOR AUTOBIOGRAPHY MODELS

For an even more striking effect, Range Rover Sport Autobiography can be personalized with the optional Stealth Design Package. Emphasizing the assertive, confident stance of the vehicle, the Stealth Design Package makes Range Rover Sport your own.

It is available in all exterior color options and includes Satin Black exterior accents. In addition the package comes with darkened exterior lighting and a choice of 21" or 22" wheels in Satin Black finish.



Grille and RANGE ROVER script in Satin Black.



Tailgate trim in Satin Black.



Mirror caps in Satin Black.



Side vent in Satin Black.

Available on HSE with Dynamic Package and Autobiography with Dynamic Package models.
Vehicle shown left is Autobiography with Dynamic Package in Fuji White with optional body-colored roof and Stealth Package.

Visit landroverusa.com to configure your vehicle online. 65

ENGINE

MODEL

COLOUR

WHEELS

INTERIOR

ACCESSORIES

TECHNICAL DETAILS



ABOVE & BEYOND

CONTENTS

SPECIFICATION

LOCATE A RETAILER

BUILD YOUR OWN

STANDARD FEATURES

Engine Transmission, Suspension and Driving Dynamics

	SE	HSE	HSE DYNAMIC	SUPERCHARGED	SUPERCHARGED DYNAMIC	AUTOBIOGRAPHY	SVR
8-speed Automatic Transmission with CommandShift® 2	■	■	■	■	■	■	■
4 Wheel Drive (4WD)	■	■	■	■	■	■	■
Intelligent Stop/Start System	■	■	■	■	■	■	■
Speed proportional Electronic Power Assisted Steering (EPAS)	■	■	■	■	■	■	■
Electric Parking Brake (EPB)	■	■	■	■	■	■	■
Anti-lock Braking System (ABS) (1)	■	■	■	■	■	■	■
Cornering Brake Control (CBC) (1)	■	■	■	■	■	■	■
Dynamic Stability Control (DSC) (1)	■	■	■	■	■	■	■
Electronic Brake-force Distribution (EBD) (1)	■	■	■	■	■	■	■
Emergency Brake Assist (EBA) (1)	■	■	■	■	■	■	■
Electronic Traction Control (ETC) (1)	■	■	■	■	■	■	■
Gradient Release Control (GRC) and Gradient Acceleration Control (GAC) (1)	■	■	■	■	■	■	■
Hill Descent Control (HDC®) (1)	■	■	■	■	■	■	■
Reactive Grounding Response (1)	■	■	■	■	■	■	■
Diesel Misfuelling Protection Device (standard with diesel engines) (2)	■	■	–	–	–	–	–
Roll Stability Control (RSC) (1)	■	■	■	■	■	■	■
Low Traction Launch	■	■	■	■	■	■	■
Electronic air suspension	■	■	■	■	■	■	■

■ Standard – Not Available.

(1) These systems are not a substitute for driving safely with due care and attention and will not function under all circumstances, speeds, weather and road conditions, etc. (2) Only fitted to TDV6 engine. Driver should not assume that these systems will correct errors of judgment in driving. Please consult the owner's manual or your local authorized Land Rover Retailer for more details.



ABOVE & BEYOND

CONTENTS

SPECIFICATION

LOCATE A RETAILER

BUILD YOUR OWN

STEP 2
CHOOSE YOUR MODEL AND OPTIONS

Exterior Features and Finishers

	SE	HSE	HSE DYNAMIC	SUPERCHARGED	SUPERCHARGED DYNAMIC	AUTOBIOGRAPHY	SVR
ROOF AND EXTERIOR DESIGN							
Roof rack mounting provisions	■	■	■	■	■	■	■
GLASS AND EXTERIOR MIRRORS							
Power windows (front and rear) with auto close	■	■	■	■	■	■	■
Rain sensing wipers	■	■	■	■	■	■	■
Winter Wiper Park Position	■	■	■	■	■	■	■
Heated rear window	■	■	■	■	■	■	■
Acoustic laminated windshield	■	■	■	■	■	■	■
Privacy glass with infrared reflective windshield	■	■	■	■	■	■	■
HEADLIGHTS AND LIGHTING							
Automatic headlights	■	■	■	■	■	■	■
Follow me home lighting	■	■	■	■	■	■	■
Side repeater indicators in mirror	■	■	■	■	■	■	■
Daytime Running Lights (DRLs)	■	■	■	■	■	■	■
TOWING							
Trailer Stability Control (1)	■	■	■	■	■	■	■
Electrical towing preparation	■	■	■	■	■	■	■
Front and rear recovery hooks	■	■	■	■	■	■	■

Wheel Features

	SE	HSE	HSE DYNAMIC	SUPERCHARGED	SUPERCHARGED DYNAMIC	AUTOBIOGRAPHY	SVR
Tire Pressure Monitoring System (TPMS)	■	■	■	■	■	■	■
Reduced section alloy spare wheel (not included with 5 + 2 seating)	■	■	■	■	■	■	■

■ Standard.

Visit landroverusa.com to configure your vehicle online. 67

ENGINE

MODEL

COLOUR

WHEELS

INTERIOR

ACCESSORIES

TECHNICAL DETAILS



ABOVE & BEYOND

CONTENTS

SPECIFICATION

LOCATE A RETAILER

BUILD YOUR OWN

STANDARD FEATURES

Seating, Interior Features and Finishers

	SE	HSE	HSE DYNAMIC	SUPERCHARGED	SUPERCHARGED DYNAMIC	AUTOBIOGRAPHY	SVR
SEATING							
Head restraints 2-way adjust (second row seats)	■	■	■	■	■	■	■
ISOFIX/LATCH seat anchorages (only in second row outer seats)	■	■	■	■	■	■	■
Second row manual recline	■	■	■	■	■	■	■
STEERING WHEEL							
Leather steering wheel with multi-functional controls	■	■	■	■	■	■	■
INTERIOR FEATURES							
Auto-dimming interior rear view mirror	■	■	■	■	■	■	■
Driver and passenger sunvisor with illuminated vanity mirror	■	■	■	■	■	■	■
Center armrest with storage box	■	■	■	■	■	■	■
Front and rear grab handles	■	■	■	■	■	■	■
Front and rear cupholders	■	■	■	■	■	■	■

Safety and Security

	SE	HSE	HSE DYNAMIC	SUPERCHARGED	SUPERCHARGED DYNAMIC	AUTOBIOGRAPHY	SVR
Single point entry, customer configurable	■	■	■	■	■	■	■
Power operated child locks	■	■	■	■	■	■	■
Driver and passenger airbags (side, seat-front, thorax, pelvis) (1)	■	■	■	■	■	■	■
Seat belt pretensioners (outer seats only in second row)	■	■	■	■	■	■	■
Front height adjustable seat belts	■	■	■	■	■	■	■
Autonomous Emergency Braking (AEB) (2)	■	■	■	■	■	■	■

■ Standard.

(1) Please remember that the safety belts in a vehicle constitute the primary protection system for driver and passengers in collisions. Airbags are not designed to deploy in all collisions. The airbag Supplemental Restraint System (SRS) is a supplement to the safety belts and is designed to work as a system with the safety belts. Although airbags provide additional protection, airbags without safety belts do not provide optimal protection in a crash. Always wear your safety belts. Children younger than 13 years old should always be properly restrained in a back seat, away from airbags. Never place an infant seat in the front seat.



ABOVE & BEYOND

CONTENTS

SPECIFICATION

LOCATE A RETAILER

BUILD YOUR OWN

STEP 2 CHOOSE YOUR MODEL AND OPTIONS

Driver Assistance, Convenience and Cargo Features

	SE	HSE	HSE DYNAMIC	SUPERCHARGED	SUPERCHARGED DYNAMIC	AUTOBIOGRAPHY	SVR
DRIVING ASSISTANCE							
Front Parking Aid (2)	■	■	■	■	■	■	■
Lane Departure Warning (1)	■	■	■	■	■	■	■
Rear Parking Aid (2)	■	■	■	■	■	■	■
Cruise Control	■	■	■	■	■	■	■
Adjustable Speed Limiter device (2)	■	■	■	■	■	■	■
CONVENIENCE FEATURES							
Push Button Start	■	■	■	■	■	■	■
Keyless Entry	■	■	■	■	■	■	■
CARGO FEATURES							
Cargo area tie-down provisions	■	■	■	■	■	■	■
Roller cargo area cover	■	■	■	■	■	■	■
Powered gesture tailgate (2)	■	■	■	■	■	■	■

Information, Communication and Entertainment

	SE	HSE	HSE DYNAMIC	SUPERCHARGED	SUPERCHARGED DYNAMIC	AUTOBIOGRAPHY	SVR
InControl Apps® (3)	■	■	■	■	■	■	■
InControl® Touch Pro Navigation (3) (4)	■	■	■	■	■	■	■
InControl® Protect (3)	■	■	■	■	■	■	■
CD / DVD Player	■	■	■	■	■	■	■
Sirius XM® Satellite Radio & HD Radio™	■	■	■	■	■	■	■
Single USB socket in cubby box	■	■	■	■	■	■	■
Bluetooth® audio streaming and Bluetooth® phone connection (4)	■	■	■	■	■	■	■
Auxiliary power sockets (front, second row and cargo area 12V)	■	■	■	■	■	■	■

■ Standard.

(2) These systems are not a substitute for driving safely with due care and attention and will not function under all circumstances, speeds, weather and road conditions, etc. Driver should not assume that these systems will correct errors of judgment in driving. Please consult the owner's manual or your local authorized Land Rover Retailer for more details (3) Do not use Land Rover InControl® features under conditions that will affect your safety or the safety of others. Driving while distracted can result in loss of vehicle control (4) Driving while distracted can result in loss of vehicle control. Do not operate, adjust or view the navigation or multimedia systems under conditions that will affect your safety or the safety of others. Only use mobile phones, and other devices, even with voice commands, when it is safe to do so.

The Bluetooth® word mark and logos are owned by the Bluetooth SIG, Inc. and any use of such marks by Land Rover is under license.

Visit landroverusa.com to configure your vehicle online. 69

ENGINE

MODEL

COLOUR

WHEELS

INTERIOR

ACCESSORIES

TECHNICAL DETAILS



ABOVE & BEYOND

CONTENTS

SPECIFICATION

LOCATE A RETAILER

BUILD YOUR OWN

OPTIONAL FEATURES

Engine, Transmission, Suspension and Driving Dynamics

	OPTION CODE	SE	HSE	HSE DYNAMIC	SUPERCHARGED	SUPERCHARGED DYNAMIC	AUTOBIOGRAPHY	SVR	DESCRIPTION
Single-speed transfer case	043BE	■	■	■	-	-	-	-	High range only.
Two-speed transfer case	043BF	□ [†]	□ [†]	-	■	■	■	■	High/low range.
SVR four-corner electronic air suspension		-	-	-	-	-	-	■	Please refer to pages 28 and 51.
Terrain Response (1) (3)		■	■	-	-	-	-	-	
Adaptive Dynamics (4)		□ [†]	□ [†]	■	■	■	■	■	
Dynamic Response (4)		-	-	-	■	■	■	■	
Terrain Response 2 Dynamic Program (1)		-	-	-	■	■	■	■	
Torque Vectoring by Braking		-	-	-	■	■	■	■	
All Terrain Progress Control (ATPC) (1) (5)		□ [†]	□ [†]	-	■	■	■	-	
Black gearshift paddles	078CB	-	-	-	■	-	-	-	
Satin Chrome gearshift paddles	078CC	-	-	■	-	■	■	■	
Unpainted brake calipers	020BG	■	■	Δ	Δ	Δ	Δ	Δ	
Red Brembo™ branded brake calipers	020BE	-	-	■	■	■	■	-	
Blue Brembo™ branded brake calipers		-	-	-	-	-	-	■	
Active Sports Exhaust		-	-	-	-	-	-	■	

■ Standard □ Optional - Not Available Δ No Cost Option □[†] Available as part of Option Package.

(1) These systems are not a substitute for driving safely with due care and attention and will not function under all circumstances, speeds, weather and road conditions, etc. Driver should not assume that these systems will correct errors of judgment in driving. Please consult the owner's manual or your local authorized Land Rover Retailer for more details (2) For Dynamic Program, Dynamic Response or Torque Vectoring see On / Off-Road Package (3) Requires single-speed transfer case (4) Requires two-speed transfer case (5) Requires Terrain Response® 2 or Terrain Response® 2 Dynamic Program.



ABOVE & BEYOND

CONTENTS

SPECIFICATION

LOCATE A RETAILER

BUILD YOUR OWN

STEP 2
CHOOSE YOUR MODEL AND OPTIONS

Exterior Features and Finishers

	OPTION CODE	SE	HSE	HSE DYNAMIC	SUPERCHARGED	SUPERCHARGED DYNAMIC	AUTOBIOGRAPHY	SVR	DESCRIPTION
ROOF AND EXTERIOR DESIGN									
Body-colored side sills and bumpers	032DE	-	-	■	-	-	■	■	
Metal roof		■	Δ	Δ	Δ	Δ	Δ	Δ	
Sliding panoramic roof	041CZ	-	□	■	■	■	■	■	Please refer to page 43.
Fixed panoramic roof	041CX	□	■	-	-	-	-	Δ	
Body-colored roof	080AC	■	■	Δ	■	■	Δ	■	
Grey contrast roof	080EE	□	□	Δ	□	□	Δ	-	
Silver contrast roof	080AD	□	□	Δ	□	□	Δ	-	Dependent on exterior color selected.
Black contrast roof	080AN	□	□	■	□	□	■	Δ	
Twin tailpipes with Bright finish		■	■	■	■	■	■	-	
Quad tailpipes with Bright finish		-	-	-	-	-	-	■	
Stealth Package (5)	074MM	-	-	-	-	-	□	-	Please refer to page 65.
Bright Package	074MQ	-	-	Δ	-	-	Δ	-	Includes Gloss Black surround and Atlas Silver mesh on the front grille, hood and fender vents, Atlas Silver fender vent fingers, hood and tailgate script and fog light surrounds, Indus Silver tow eye covers and Satin Chrome tailgate finisher.
Carbon Fiber engine cover	063AC	-	-	-	-	-	-	□	
GLASS AND EXTERIOR MIRRORS									
Heated windshield	040AK	□	□	□	□	□	□	□	
Power fold, heated door mirrors with approach lights (6)	030NM	■	■	-	■	■	-	-	Approach lights include illuminated Range Rover graphic.
Auto-dimming exterior mirrors (6)	031EB	□†	□†	■	□†	□†	■	■	Power fold, heated door mirrors with approach lights and auto-dimming function. Approach lights include illuminated Range Rover graphic.

■ Standard □ Optional - Not Available Δ No Cost Option □† Available as part of Option Package.

(5) Only available with 21" or 22" wheels in Satin Black finish (6) Includes memory and auto reverse dipping function when ordered with seats with memory.

Visit landroverusa.com to configure your vehicle online.



ABOVE & BEYOND

CONTENTS

SPECIFICATION

LOCATE A RETAILER

BUILD YOUR OWN

OPTIONAL FEATURES

Exterior Features and Finishers (continued)

	OPTION CODE	SE	HSE	HSE DYNAMIC	SUPERCHARGED	SUPERCHARGED DYNAMIC	AUTOBIOGRAPHY	SVR	DESCRIPTION
HEADLIGHTS AND LIGHTING									
Front fog lights	064AP	<input type="checkbox"/>	<input checked="" type="checkbox"/>	<input checked="" type="checkbox"/>	<input checked="" type="checkbox"/>	<input checked="" type="checkbox"/>	<input checked="" type="checkbox"/>	-	
Xenon headlights with LED signature		<input checked="" type="checkbox"/>	<input checked="" type="checkbox"/>	-	<input checked="" type="checkbox"/>	<input checked="" type="checkbox"/>	-	-	
Adaptive Xenon headlights (1) with LED signature	064DI	<input checked="" type="checkbox"/>	<input checked="" type="checkbox"/>	<input checked="" type="checkbox"/>	<input checked="" type="checkbox"/>	<input checked="" type="checkbox"/>	<input checked="" type="checkbox"/>	<input checked="" type="checkbox"/>	
Automatic High Beam Assist (AHBA) (1)	030NT	<input checked="" type="checkbox"/>	<input checked="" type="checkbox"/>	<input checked="" type="checkbox"/>	<input checked="" type="checkbox"/>	<input checked="" type="checkbox"/>	<input checked="" type="checkbox"/>	<input checked="" type="checkbox"/>	Automatic High Beam Assist headlights automatically switch to low beam when traffic is detected, reverting to high beam when vehicles have passed.
PAINT									
Solid paint		<input type="checkbox"/>	<input type="checkbox"/>	<input type="checkbox"/>	<input type="checkbox"/>	<input type="checkbox"/>	<input type="checkbox"/>	<input type="checkbox"/>	
Metallic paint		<input type="checkbox"/>	<input type="checkbox"/>	<input type="checkbox"/>	<input type="checkbox"/>	<input type="checkbox"/>	<input type="checkbox"/>	<input type="checkbox"/>	
Premium metallic paint		<input type="checkbox"/>	<input type="checkbox"/>	<input type="checkbox"/>	<input type="checkbox"/>	<input type="checkbox"/>	<input type="checkbox"/>	<input type="checkbox"/>	
SVO Premium Palette – ultra metallic	519SV	<input type="checkbox"/>	<input type="checkbox"/>	<input type="checkbox"/>	<input type="checkbox"/>	<input type="checkbox"/>	<input type="checkbox"/>	<input type="checkbox"/>	
SVO Premium Palette – special effect colors and satin matte finish	503SV	<input type="checkbox"/>	<input type="checkbox"/>	<input type="checkbox"/>	<input type="checkbox"/>	<input type="checkbox"/>	<input type="checkbox"/>	<input type="checkbox"/>	The availability of exterior paint colors varies by model and by time of year. Please contact your nearest Land Rover Retailer for further details. Please refer to pages 82-89.
TOWING									
Advanced Tow Assist (1)	062CE	<input type="checkbox"/>	<input type="checkbox"/>	-	<input type="checkbox"/>	<input type="checkbox"/>	<input type="checkbox"/>	<input type="checkbox"/>	Requires Surround Camera System, All Terrain Progress Control and Terrain Response 2 or Terrain Response 2 Dynamic Program. Requires Land Rover approved tow hitch. Please refer to page 35.

Wheel Features

	OPTION CODE	SE	HSE	HSE DYNAMIC	SUPERCHARGED	SUPERCHARGED DYNAMIC	AUTOBIOGRAPHY	SVR	DESCRIPTION
Tire Repair System	029SJ	<input checked="" type="checkbox"/>	<input type="checkbox"/>	<input type="checkbox"/>	<input type="checkbox"/>	<input type="checkbox"/>	<input type="checkbox"/>	-	Only for vehicles with 5 + 2 third row seating.
Full size spare wheel	029MI	<input type="checkbox"/>	<input type="checkbox"/>	<input type="checkbox"/>	<input type="checkbox"/>	<input type="checkbox"/>	<input type="checkbox"/>	-	Not available with 5 + 2 Seating.

■ Standard □ Optional – Not Available ☐ Available as part of Option Package.

(1) These systems are not a substitute for driving safely with due care and attention and will not function under all circumstances, speeds, weather and road conditions, etc. Driver should not assume that these systems will correct errors of judgment in driving. Please consult the owner's manual or your local authorized Land Rover Retailer for more details.



ABOVE & BEYOND

CONTENTS

SPECIFICATION

LOCATE A RETAILER

BUILD YOUR OWN

STEP 2
CHOOSE YOUR MODEL AND OPTIONS

Seating, Interior Features and Finishers

	OPTION CODE	SE	HSE	HSE DYNAMIC	SUPERCHARGED	SUPERCHARGED DYNAMIC	AUTOBIOGRAPHY	SVR	DESCRIPTION
SEATING									
Grained leather seats	033TB	■	-	-	-	-	-	-	
Perforated Oxford leather seats	033JK	-	■	-	■	■	-	-	
Perforated Oxford leather seats with unique pattern (Single / Duo / Tri tone)		-	-	■	-	-	■	-	
Perforated Oxford leather seats with SVR pattern		-	-	-	-	-	-	■	
16-way power front seats with memory (1)	033KZ	■	■	-	■	■	-	-	All 16-way power front seat movements plus memory functionality.
16-way power front seats with memory and powered headrest (1)	033SZ	-	□†	■	□†	□†	■	-	All 16-way front seats with driver and passenger memory 4 way lumbar and power headrests.
18-way power front seats with memory and massage (1)	033TT	-	-	-	-	-	□	-	All 18-way power front seats with memory movements, plus upper seat articulation and massage functionality.
14-way power front SVR Sport seats with memory (2)	033TV	-	-	-	-	-	-	■	All 14-way Sport front seats with driver and passenger memory and 4 way lumbar.

■ Standard □ Optional - Not Available □† Available as part of Option Package.

(1) Not available with 10" Rear Seat Entertainment (2) Not available with 8" or 10" Rear Seat Entertainment.

Visit landroverusa.com to configure your vehicle online. 73

ENGINE

MODEL

COLOUR

WHEELS

INTERIOR

ACCESSORIES

TECHNICAL DETAILS



ABOVE & BEYOND

CONTENTS

SPECIFICATION

LOCATE A RETAILER

BUILD YOUR OWN

OPTIONAL FEATURES

Seating, Interior Features and Finishers (continued)

	OPTION CODE	SE	HSE	HSE DYNAMIC	SUPERCHARGED	SUPERCHARGED DYNAMIC	AUTOBIOGRAPHY	SVR	DESCRIPTION
SEATING									
Heated front seats	033BV	–	■	–	■	■	–	–	
Heated front and rear seats	033EQ	□†	–	–	–	–	–	■	Heats the front seats and outer second row seats.
Heated and cooled front seats with heated rear seats	033GQ	–	□†	■	□†	□	■	–	On the second row, heats the outer seats only.
Heated and cooled front and rear seats	033IN	–	□†	□†	□†	□†	□†	–	Requires three-zone or four-zone Climate Control. On the second row, heats and cools the outer seats only.
60:40 second row seat fold		–	–	–	–	–	–	■	Not available with 5 + 2 Seating.
60:40 second row folding seats with load through	033CW	■	■	■	■	■	■	–	
60:40 second row folding seats with load through, tilt and slide	033NC	□	□	□	□	□	□	–	Standard with 5 + 2 Seating.
Powered 5 + 2 Seating	033BI	□†	□	□	□	□	□	–	Please refer to page 10.
STEERING WHEEL									
Power adjustable steering column	049AL	■	■	■	■	■	■	■	Includes reach/rake on steering wheel. Includes entry and exit tilt away when memory seats are specified.
Heated leather steering wheel	032FB	□†	□†	■	□†	□†	■	■	With Audio Controls and Cruise Control.
Heated leather steering wheel with Carbon Fiber bezel*	032FD	–	–	–	–	–	–	□	

■ Standard □ Optional – Not Available □† Available as part of Option Package.

*Only available with Carbon Fiber veneer.



ABOVE & BEYOND

CONTENTS

SPECIFICATION

LOCATE A RETAILER

BUILD YOUR OWN

STEP 2
CHOOSE YOUR MODEL AND OPTIONS

Seating, Interior Features and Finishers (continued)

	OPTION CODE	SE	HSE	HSE DYNAMIC	SUPERCHARGED	SUPERCHARGED DYNAMIC	AUTOBIOGRAPHY	SVR	DESCRIPTION
INTERIOR FINISHERS									
	Dark Satin Brushed Aluminum trim finisher	■	-	-	-	-	-	-	Please refer to pages 100-101.
	Micro Mesh Aluminum trim finisher	-	■	-	■	-	-	-	Please refer to pages 100-101.
	Sport Textured Aluminum trim finisher	-	-	-	-	-	■	-	Please refer to pages 100-101.
	Dark Engine Turned Aluminum trim finisher	-	-	■	-	-	■	■	Please refer to pages 100-101.
	Shadow Zebrano veneer (1)	088HB	□	□	□	□	-	-	Please refer to pages 100-101.
	Dark Grey Oak veneer (1)	088GM	□	□	□	□	-	-	Please refer to pages 100-101.
	Grand Black veneer	088HS	-	□	□	□	-	-	Please refer to pages 100-101.
	Carbon Fiber veneer	088JF	-	-	-	-	-	□	
	Extended Shadow Zebrano veneer (2)	088JC	-	-	-	-	□	-	Includes additional veneers on front and rear doors. Also includes additional door storage and additional Configurable Interior Mood Lighting.
	Extended Dark Grey Oak veneer (2)	088HZ	-	-	-	-	□	-	
	Extended Grand Black veneer (2)	088JD	-	-	-	-	□	-	
HEADLINING									
	Morzine headlining	088HH	■	■	■	■	■	■	Cirrus or Ivory dependent on colorway.
	Ebony Morzine headlining	005BJ	□	□	□	□	□	□	

■ Standard □ Optional - Not Available.

(1) Please see pages 94-95 for Color and Trim matrix for availability (2) Only available with Configurable Interior Mood Lighting.

Visit landroverusa.com to configure your vehicle online. 75

ENGINE

MODEL

COLOUR

WHEELS

INTERIOR

ACCESSORIES

TECHNICAL DETAILS



ABOVE & BEYOND

CONTENTS

SPECIFICATION

LOCATE A RETAILER

BUILD YOUR OWN

OPTIONAL FEATURES

Seating, Interior Features and Finishers (continued)

	OPTION CODE	SE	HSE	HSE DYNAMIC	SUPERCHARGED	SUPERCHARGED DYNAMIC	AUTOBIOGRAPHY	SVR	DESCRIPTION
INTERIOR FEATURES									
Single blade sunvisor		■	■	–	■	■	–	–	
Twin blade sunvisor	115AP	□†	□†	■	□†	□†	■	■	
Carpet mats	079AJ	■	■	–	■	■	–	–	
Front and rear premium carpet mats	079CA	–	–	■	–	□†	■	■	
Aluminum treadplates	048AR	–	■	■	■	■	■	■	With Range Rover script on front door treadplates.
Bright Sport pedals	051AJ	–	–	■	–	■	■	■	
Front center console cooler compartment	038EA	–	□	□†	□	□	□†	Δ	
Two-zone Climate Control	022AY / 022BM	■	■	–	■	■	–	–	Please refer to page 43.
Three-zone Climate Control	022BC / 022BK	–	–	■	–	–	■	■	Please refer to page 43.
Four-zone Climate Control	022BG / 022BL	–	□†	□†	□†	□†	□†	□	Please refer to page 43.
Interior Mood Lighting		■	■	–	■	■	–	–	Please refer to page 43.
Configurable Interior Mood Lighting	064FM	□†	□†	■	□†	□†	■	■	
Smoker's Package	094AA	Δ	Δ	Δ	Δ	Δ	Δ	Δ	Includes front row ashtray and cigar lighter
Extended Leather Package	032CG	–	□	–	□	□	–	–	Additional leather added to the instrument panel and door top. Please refer to page 96 for color details.

■ Standard □ Optional – Not Available Δ No Cost Option □† Available as part of Option Package.



ABOVE & BEYOND

CONTENTS

SPECIFICATION

LOCATE A RETAILER

BUILD YOUR OWN

STEP 2 CHOOSE YOUR MODEL AND OPTIONS

Driver Assistance, Convenience and Cargo Features

	OPTION CODE	SE	HSE	HSE DYNAMIC	SUPERCHARGED	SUPERCHARGED DYNAMIC	AUTOBIOGRAPHY	SVR	DESCRIPTION
DRIVER ASSISTANCE									
Park Assist (1)	086HA	<input type="checkbox"/>	<input type="checkbox"/>	<input type="checkbox"/>	<input type="checkbox"/>	<input type="checkbox"/>	<input type="checkbox"/>	<input type="checkbox"/>	Includes Parallel Parking / Park Exit / Perpendicular Park. Requires 360° Parking Aid. Please refer to pages 32-33.
Rear View Camera (1)	086FA	<input checked="" type="checkbox"/>	<input checked="" type="checkbox"/>	<input checked="" type="checkbox"/>	<input checked="" type="checkbox"/>	<input checked="" type="checkbox"/>	-	-	Includes Tow Hitch Assist. Please refer to pages 32-33.
Surround Camera System (1) (2)	086GC	<input type="checkbox"/>	<input type="checkbox"/>	<input style="border: 1px solid black; width: 10px; height: 10px; display: inline-block; vertical-align: middle;" type="checkbox"/>	<input type="checkbox"/>	<input type="checkbox"/>	<input checked="" type="checkbox"/>	<input checked="" type="checkbox"/>	Includes Tow Hitch Assist. Please refer to pages 32-33.
360° Parking Aid (1)	036MB	<input type="checkbox"/>	<input type="checkbox"/>	<input checked="" type="checkbox"/>	<input type="checkbox"/>	<input type="checkbox"/>	<input checked="" type="checkbox"/>	<input checked="" type="checkbox"/>	
Drive Package (1)	074VX	<input type="checkbox"/>	<input type="checkbox"/>	-	<input type="checkbox"/>	<input type="checkbox"/>	-	-	Includes Driver Condition Monitor, Blind Spot Monitor with Reverse Traffic Detection and Intelligent Speed Limiter and Traffic Sign Recognition.
Driver Condition Monitor (1)		<input style="border: 1px solid black; width: 10px; height: 10px; display: inline-block; vertical-align: middle;" type="checkbox"/>	<input style="border: 1px solid black; width: 10px; height: 10px; display: inline-block; vertical-align: middle;" type="checkbox"/>	-	<input style="border: 1px solid black; width: 10px; height: 10px; display: inline-block; vertical-align: middle;" type="checkbox"/>	<input style="border: 1px solid black; width: 10px; height: 10px; display: inline-block; vertical-align: middle;" type="checkbox"/>	-	-	Please refer to page 32.
Traffic Sign Recognition and Intelligent Speed Limiter (1)		<input style="border: 1px solid black; width: 10px; height: 10px; display: inline-block; vertical-align: middle;" type="checkbox"/>	<input style="border: 1px solid black; width: 10px; height: 10px; display: inline-block; vertical-align: middle;" type="checkbox"/>	-	<input style="border: 1px solid black; width: 10px; height: 10px; display: inline-block; vertical-align: middle;" type="checkbox"/>	<input style="border: 1px solid black; width: 10px; height: 10px; display: inline-block; vertical-align: middle;" type="checkbox"/>	-	-	Please refer to page 31.
Blind Spot Monitor with Reverse Traffic Detection (1) (3)		<input style="border: 1px solid black; width: 10px; height: 10px; display: inline-block; vertical-align: middle;" type="checkbox"/>	<input style="border: 1px solid black; width: 10px; height: 10px; display: inline-block; vertical-align: middle;" type="checkbox"/>	-	<input style="border: 1px solid black; width: 10px; height: 10px; display: inline-block; vertical-align: middle;" type="checkbox"/>	<input style="border: 1px solid black; width: 10px; height: 10px; display: inline-block; vertical-align: middle;" type="checkbox"/>	-	-	Please refer to pages 32-33.

■ Standard □ Optional □[†] Available as part of Option Package.

(1) These systems are not a substitute for driving safely with due care and attention and will not function under all circumstances, speeds, weather and road conditions, etc. Driver should not assume that these systems will correct errors of judgment in driving. Please consult the owner's manual or your local authorized Land Rover Retailer for more details (2) Only available with power fold, heated door mirrors or auto-dimming exterior mirrors (3) Only available with auto-dimming exterior mirrors.

Visit landroverusa.com to configure your vehicle online. 77

ENGINE

MODEL

COLOUR

WHEELS

INTERIOR

ACCESSORIES

TECHNICAL DETAILS



ABOVE & BEYOND

CONTENTS

SPECIFICATION

LOCATE A RETAILER

BUILD YOUR OWN

OPTIONAL FEATURES

Driver Assistance, Convenience and Cargo Features (continued)

	OPTION CODE	SE	HSE	HSE DYNAMIC	SUPERCHARGED	SUPERCHARGED DYNAMIC	AUTOBIOGRAPHY	SVR	DESCRIPTION
DRIVER ASSISTANCE									
Drive Pro Package (1)	074VY	□	□	□	□	□	□	□	Includes Driver Condition Monitor, Intelligent Speed Limiter and Traffic Sign Recognition, Adaptive Cruise Control, Lane Keep Assist and Blind Spot Assist with Reverse Traffic Detection. Requires auto-dimming exterior mirrors.
Lane Keep Assist (1)		□†	□†	□†	□†	□†	□†	□†	Please refer to pages 32-33.
Adaptive Cruise Control with Queue Assist and Intelligent Emergency Braking (1)		□†	□†	□†	□†	□†	□†	□†	Please refer to pages 32-33.
Blind Spot Assist with Reverse Traffic Detection (1) (2)		□†	□†	□†	□†	□†	□†	□†	Working with Blind Spot Monitor, Blind Spot Assist can help prevent collisions. If your vehicle detects another vehicle in your blind spot when you begin to change lanes, Blind Spot Assist provides precisely calculated steering torque – supporting the driver in guiding your vehicle safely away from the approaching vehicle.
CONVENIENCE FEATURES									
Garage door opener (HomeLink®) (3)	025CT	□†	■	■	■	■	■	■	This universal transmitter can be programmed to operate up to three home or office wireless controlled systems, such as garage doors, automatic gates, or security lighting.
Soft door close (4)	173AB	□†	□†	□†	□†	□†	■	□	Please refer to page 44.

■ Standard □ Optional – Not Available □† Available as part of Option Package.

(1) These systems are not a substitute for driving safely with due care and attention and will not function under all circumstances, speeds, weather and road conditions, etc. Driver should not assume that these systems will correct errors of judgment in driving. Please consult the owner's manual or your local authorized Land Rover Retailer for more details (2) Only available with auto-dimming exterior mirrors (3) Requires auto-dimming interior mirror (4) Requires Keyless Entry. HomeLink® is the registered trademark of Gentex Corporation.



ABOVE & BEYOND

CONTENTS

SPECIFICATION

LOCATE A RETAILER

BUILD YOUR OWN

STEP 2
CHOOSE YOUR MODEL AND OPTIONS

Information, Communication and Entertainment

	OPTION CODE	SE	HSE	HSE DYNAMIC	SUPERCHARGED	SUPERCHARGED DYNAMIC	AUTOBIOGRAPHY	SVR	DESCRIPTION
Range Rover Audio System		■	■	–	■	■	–	–	250W with 8 speakers.
Meridian™ Surround Sound System	025LN	□	□	■	□	□	■	■	825W with 18 speakers plus subwoofer. Please refer to page 40.
Meridian™ Reference Sound System	025LV	–	–	□	□	□	□	□	1700W with 22 speakers plus subwoofer. Please refer to page 40.
Analog dials with 5" full color TFT display		■	■	–	■	–	–	–	
TFT virtual instrument panel	038ID	–	□†	■	□†	■	■	■	Please refer to page 31.
8" Rear Seat Entertainment (5)	129AH	□	□	□	□	□	–	–	Mounted to front headrests. With remote control and two sets of wireless headphones (one USB port in second row). Please refer to page 44.
10" Rear Seat Entertainment (5) (6)	129AQ	–	–	–	–	–	□	–	Mounted to front seatbacks.
Head-up Display (7) (8)	039IB	□	□	□	□	□	□	□	Please refer to page 31.

■ Standard □ Optional – Not Available □† Available as part of Option Package.

(5) Requires: 60:40 second row folding seats with load through and 825W or 1700W Sound System (6) Requires 20-way electric front seats with memory and massage (7) Requires infrared reflective glass or privacy glass with infrared reflective glass (8) These features are not a substitute for driving safely with due care and attention and will not function under all circumstances, speeds, weather and road conditions, etc. Driver should not assume that these features will correct errors of judgment in driving. Please consult the owner's manual or your local authorized Land Rover Retailer for more details.

Visit landroverusa.com to configure your vehicle online. 79

ENGINE

MODEL

COLOUR

WHEELS

INTERIOR

ACCESSORIES

TECHNICAL DETAILS



ABOVE & BEYOND

CONTENTS

SPECIFICATION

LOCATE A RETAILER

BUILD YOUR OWN

OPTIONAL FEATURES

Option Packs

	OPTION CODE	SE	HSE	HSE DYNAMIC	SUPERCHARGED	SUPERCHARGED DYNAMIC	AUTOBIOGRAPHY	SVR
OFF ROAD PACKAGE	074QA	□	□	-	-	-	-	-
Terrain Response® 2	088IA							
Twin-Speed Transfer Box (High/Low Range)	043BF							
All Terrain Progress Control (ATPC)	095CB							
Adaptive Dynamics	027CW							
CLIMATE COMFORT AND VISIBILITY PACKAGE	075FA	□	-	-	-	-	-	-
Heated front and rear seats	033EQ							
Heated leather steering wheel	032FB							
Garage door opener (HomeLink®)	025FF							
Twin-blade sunvisor with illuminated vanity mirrors	115AP							
Auto-dimming exterior mirrors	031EB							
Front fog lights	064AP							
Auto High Beam Assist (AHBA)	030NT							
Adaptive Xenon headlights with LED signature	064DI							
FRONT CLIMATE COMFORT AND VISIBILITY PACKAGE	075FB	-	□	-	□	□	-	-
Climate front seats and heated rear seats	033GQ							
Heated Leather Steering Wheel	032FB							
Style 4 – 16 way / 16 way powered seats with powered headrest and memory	033SZ							
Auto High Beam Assist (AHBA)	030NT							
Auto-dimming exterior mirrors	031EB							
Twin-blade sunvisor with illuminated vanity mirrors	115AP							
Adaptive Xenon headlights with LED signature	064DI							

□ Optional – Not Available.



ABOVE & BEYOND

CONTENTS

SPECIFICATION

LOCATE A RETAILER

BUILD YOUR OWN

Option Packs (continued)

	OPTION CODE	SE	HSE	HSE DYNAMIC	SUPERCHARGED	SUPERCHARGED DYNAMIC	AUTOBIOGRAPHY	SVR
LUXURY CLIMATE COMFORT PACKAGE VISIBILITY PACKAGE	075FF	-	□	-	□	□	-	-
Climate front and rear seats	033IN							
Heated leather steering wheel	032FB							
Style 4 – 16 way / 16 way powered seats with powered headrest and memory	033SZ							
4-Zone Climate Control	022BG							
Auto High Beam Assist (AHBA)	030NT							
Auto-dimming exterior mirrors	031EB							
Twin-blade sunvisor with illuminated vanity mirrors	115AP							
Adaptive Xenon headlights with LED signature	064DI							
VISION AND CONVENIENCE PACKAGE	074MR	□	□	□	□	□	-	-
Surround Camera System	086GC							
TFT Virtual Instrument Panel	038ID	-		-		-		
Customer Configurable Interior Mood Lighting	064FM			-				
Soft Door Close	173AB	-						
THIRD ROW SEATING PACKAGE	033UB	□	-	-	-	-	-	-
Third row seats	033BI							
Tire Repair System (deletes spare tire)	029FJ							
20" 5 split spoke 'Style 520'	029YT							
CLIMATE COMFORT PACKAGE	072BD	-	-	□	-	-	□	-
4-Zone Climate Control	022BG							
Front Center console cooler compartment	038EA							
Climate front and rear seats	033IN							

□ Optional – Not Available.

Visit landroverusa.com to configure your vehicle online. 81

ENGINE

MODEL

COLOUR

WHEELS

INTERIOR

ACCESSORIES

TECHNICAL DETAILS



ABOVE & BEYOND

CONTENTS

SPECIFICATION

LOCATE A RETAILER

BUILD YOUR OWN

3

There is a distinctive range of specifically formulated colors and finishes. Choose from 4 categories of colors: solid & metallic, premium metallic, ultra metallic and special effect.

SOLID AND METALLIC COLORS

A standard range of 13 specifically formulated solid and metallic colors and finishes are available.

Body and Roof Color

Further enhance the look by selecting a contrast roof with a choice of Narvik Black, Corris Grey or Indus Silver (dependent on exterior color selected).

Fuji White (solid)*

Optional Contrast Roof Color

Narvik Black Corris Grey



Narvik Black (solid)

Optional Contrast Roof Color

Narvik Black Corris Grey



Indus Silver (metallic)*

Optional Contrast Roof Color

Narvik Black Corris Grey



Yulong White (metallic)*

Optional Contrast Roof Color

Narvik Black Corris Grey



Corris Grey (metallic)*

Optional Contrast Roof Color

Narvik Black Indus Silver



*Denotes availability on SVR model.

The availability of exterior paint colors varies by model and by time of year. Please contact your nearest Land Rover Retailer for further details.



ABOVE & BEYOND

CONTENTS

SPECIFICATION

LOCATE A RETAILER

BUILD YOUR OWN

STEP 3 CHOOSE YOUR COLOR

Kaikoura Stone (metallic)

Optional Contrast Roof Color

Narvik Black Corris Grey



Zanzibar (metallic)

Optional Contrast Roof Color

Narvik Black Corris Grey Indus Silver



Scotia Grey (metallic)*

Optional Contrast Roof Color

Narvik Black Indus Silver



Aintree Green (metallic)

Optional Contrast Roof Color

Narvik Black Corris Grey Indus Silver



Visit landroverusa.com to configure your vehicle online. 83

ENGINE

MODEL

COLOUR

WHEELS

INTERIOR

ACCESSORIES

TECHNICAL DETAILS



ABOVE & BEYOND

CONTENTS

SPECIFICATION

LOCATE A RETAILER

BUILD YOUR OWN

Loire Blue (metallic)

Optional Contrast Roof Color

Narvik Black Corris Grey Indus Silver



Santorini Black (metallic)*

Optional Contrast Roof Color

Corris Grey Indus Silver



Firenze Red (metallic)*

Optional Contrast Roof Color

Narvik Black Corris Grey Indus Silver



Montalcino Red (metallic)

Optional Contrast Roof Color

Narvik Black Indus Silver



*Denotes availability on SVR model.

The availability of exterior paint colors varies by model and by time of year. Please contact your nearest Land Rover Retailer for further details.



ABOVE & BEYOND

CONTENTS

SPECIFICATION

LOCATE A RETAILER

BUILD YOUR OWN

STEP 3 CHOOSE YOUR COLOR

PREMIUM METALLIC COLORS

An optional range of 6 specifically formulated premium metallic colors and finishes are available.

Estoril Blue (SVR model only)*

Optional Contrast Roof Color

Narvik Black



Body and Roof Color

Further enhance the look by selecting a contrast roof with a choice of Narvik Black, Corris Grey or Indus Silver (dependent on exterior color selected).

Silicon Silver

Optional Contrast Roof Color

Narvik Black

Indus Silver



Aruba

Optional Contrast Roof Color

Narvik Black

Corris Grey



Waitomo Grey

Optional Contrast Roof Color

Narvik Black

Indus Silver



Carpathian Grey

Optional Contrast Roof Color

Narvik Black

Corris Grey

Indus Silver



Farallon Black

Optional Contrast Roof Color

Corris Grey

Indus Silver

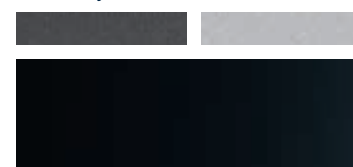

Visit landroverusa.com to configure your vehicle online. 85

ENGINE

MODEL

COLOUR

WHEELS

INTERIOR

ACCESSORIES

TECHNICAL DETAILS



ABOVE & BEYOND

CONTENTS

SPECIFICATION

LOCATE A RETAILER

BUILD YOUR OWN

ULTRA METALLIC COLORS

An optional range of 13 specifically formulated ultra metallic premium palette colors and finishes are available. These are the latest high technology colors and finishes delivered by our new SVO facility. All ultra metallic colors come in a gloss finish or, as an additional option, satin matte finish.

Body and Roof Color

Further enhance the look by selecting a contrast roof with a choice of Narvik Black, Corris Grey or Indus Silver (dependent on exterior color selected).

Verbier Silver[†]

Optional Contrast Roof Color
Narvik Black



Rio Gold[†]

Optional Contrast Roof Color
Narvik Black



Madagascar Orange[†]

Optional Contrast Roof Color
Narvik Black Indus Silver



Balmoral Blue[†]

Optional Contrast Roof Color
Narvik Black Indus Silver





ABOVE & BEYOND

CONTENTS

SPECIFICATION

LOCATE A RETAILER

BUILD YOUR OWN

STEP 3 CHOOSE YOUR COLOR

Ruffina Red[†]

Optional Contrast Roof Color
Narvik Black Indus Silver



Mescalito Black[†]

Optional Contrast Roof Color
Indus Silver



British Racing Green[†]

Optional Contrast Roof Color
Narvik Black



Visit landroverusa.com to configure your vehicle online. 87

ENGINE

MODEL

COLOUR

WHEELS

INTERIOR

ACCESSORIES

TECHNICAL DETAILS



ABOVE & BEYOND

CONTENTS

SPECIFICATION

LOCATE A RETAILER

BUILD YOUR OWN

Windward Grey[†]

Optional Contrast Roof Color

Narvik Black Indus Silver



Scafell Grey[†]

Optional Contrast Roof Color

Narvik Black Indus Silver



Bosphorus Grey[†]

Optional Contrast Roof Color

Narvik Black Indus Silver



Borealis Black[†]

Optional Contrast Roof Color

Corris Grey Indus Silver

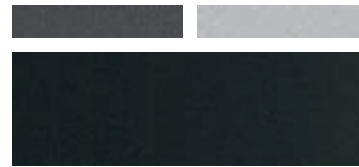

Flux[†]

Optional Contrast Roof Color

Narvik Black Indus Silver



Ligurian Black[†]

Optional Contrast Roof Color

Indus Silver



[†]Available in satin matte finish (priced as special effect colors).
The availability of exterior paint colors varies by model and by time of year. Please contact your nearest Land Rover Retailer for further details.



ABOVE & BEYOND

CONTENTS

SPECIFICATION

LOCATE A RETAILER

BUILD YOUR OWN

STEP 3 CHOOSE YOUR COLOR

SPECIAL EFFECT COLORS

An optional range of 6 specifically formulated special effect premium palette colors and finishes are available: pearlescent, ChromaFlair® and tinted clearcoat. These are the latest high technology colors and finishes delivered by our new SVO facility. All special effect colors come in a gloss finish or, as an additional option, satin matte finish (except Camargue Red tinted clearcoat which is available in gloss finish only).

Body and Roof Color

Further enhance the look by selecting a contrast roof with a choice of Narvik Black, Corris Grey or Indus Silver (dependent on exterior color selected).

Valloire White Pearl (pearlescent)[†]

Optional Contrast Roof Color
Narvik Black Corris Grey



Meribel White Pearl (pearlescent)[†]

Optional Contrast Roof Color
Narvik Black Corris Grey



Spectral Blue (ChromaFlair)[†]

Optional Contrast Roof Color
Narvik Black



Spectral British Racing Green (ChromaFlair)[†]

Optional Contrast Roof Color
Narvik Black



Spectral Racing Red (ChromaFlair)[†]

Optional Contrast Roof Color
Narvik Black



Camargue Red (tinted clearcoat)

Optional Contrast Roof Color
Narvik Black Indus Silver



ChromaFlair® is a registered trademark of Viavi Solutions.

Visit landroverusa.com to configure your vehicle online. 89

ENGINE

MODEL

COLOUR

WHEELS

INTERIOR

ACCESSORIES

TECHNICAL DETAILS



ABOVE & BEYOND

CONTENTS

SPECIFICATION

LOCATE A RETAILER

BUILD YOUR OWN

4



19" 5 SPLIT-SPOKE
'STYLE 501'^{**†}



19" 5 SPLIT-SPOKE
'STYLE 501'
WITH SATIN DARK GREY FINISH[†]



20" 5 SPLIT-SPOKE
'STYLE 520'^{*}



20" 5 SPLIT-SPOKE
'STYLE 520'
WITH GLOSS BLACK FINISH^{**}



21" 5 SPLIT-SPOKE
'STYLE 507'^{*}



21" 5 SPLIT-SPOKE
'STYLE 507'
WITH DIAMOND TURNED FINISH^{*}



21" 5 SPLIT-SPOKE
'STYLE 507'
WITH SATIN DARK GREY FINISH

	OPTION CODE	SE	HSE	HSE DYNAMIC	SUPERCHARGED	SUPERCHARGED DYNAMIC	AUTOBIOGRAPHY	SVR
WHEELS								
19" 5 split-spoke 'Style 501'	029SA	■	-	-	-	-	-	-
19" 5 split-spoke 'Style 501' with Satin Dark Grey finish	029XR	□	-	-	-	-	-	-
20" 5 split-spoke 'Style 520' [*]	029YT	□ [†]	■	-	■	△	-	-
20" 5 split-spoke 'Style 520' with Gloss Black finish ^{**}	VPLWW0090	◇	◇	◇	◇	◇	◇	-
21" 5 split-spoke 'Style 507' [*]	029YU	□	□	-	-	-	-	-
21" 5 split-spoke 'Style 507' with Diamond Turned finish [*]	029YV	-	□	□	□	□	■	-
21" 5 split-spoke 'Style 507' with Satin Grey finish ^{**}	031GA	-	-	■	-	■	-	-

■ Standard □ Optional - Not Available □[†] Available as part of Option Package △ No Cost Option ◇ Accessory fit only.

*Also available as an accessory. Rim only. Center caps available separately **Only available as an accessory. Rim only. Center caps available separately. Accessory wheels must be selected with a standard wheel and incur an additional cost. Accessory wheels not available on SVR model [†]Not available with 5 + 2 Seating ^{*}Not available with full size spare wheel.



ABOVE & BEYOND

CONTENTS

SPECIFICATION

LOCATE A RETAILER

BUILD YOUR OWN

STEP 4
CHOOSE YOUR WHEELS



21" 5 SPLIT-SPOKE
'STYLE 505'



21" 9 SPOKE
'STYLE 901'
WITH SATIN BLACK FINISH*



21" 5 SPLIT-SPOKE
'STYLE 517'[†]



22" 5 SPLIT-SPOKE
'STYLE 504'[†]



22" 5 SPLIT-SPOKE
'STYLE 508'
WITH SATIN BLACK FINISH[†]



22" 10 SPLIT-SPOKE
'STYLE 108'[†]



22" 10 SPLIT-SPOKE
'STYLE 108'
WITH GLOSS BLACK FINISH[†]

	OPTION CODE	SE	HSE	HSE DYNAMIC	SUPERCHARGED	SUPERCHARGED DYNAMIC	AUTOBIOGRAPHY	SVR
WHEELS								
21" 5 split-spoke 'Style 505'	029SW	-	-	-	-	-	Δ	-
21" 9 spoke 'Style 901' with Satin Black finish (available with Stealth Package)*	029YW	-	-	-	-	-	□	-
21" 5 split-spoke 'Style 517' [†]	029TT	-	-	-	-	-	-	■
22" 5 split-spoke 'Style 504' [†]	029SF	-	□	□	□	□	□	-
22" 5 split-spoke 'Style 508' with Satin Black finish (only available with Stealth Package) [†]	029YX	-	-	-	-	-	□	-
22" 10 split-spoke 'Style 108' [†]	029TU	-	-	-	-	-	-	□
22" 10 split-spoke 'Style 108' with Gloss Black finish [†]	031PU	-	-	-	-	-	-	□

■ Standard □ Optional - Not Available [†] Available as part of Option Package Δ No Cost Option.

Visit landroverusa.com to configure your vehicle online.

ENGINE

MODEL

COLOUR

WHEELS

INTERIOR

ACCESSORIES

TECHNICAL DETAILS

5

CHOOSE YOUR SEAT CONFIGURATION



5 Seats

The seat configuration has been intelligently engineered to accommodate the lines of the roofline. The cabin is light and spacious, ensuring everyone has a relaxed and comfortable journey. There is generous leg, shoulder and head room throughout the contemporary cabin.



ABOVE & BEYOND

CONTENTS

SPECIFICATION

LOCATE A RETAILER

BUILD YOUR OWN

STEP 5 CHOOSE YOUR INTERIOR



5 + 2 Seating

The 5 + 2 arrangement has two seats stowed under the floor of the luggage compartment that can be used for occasional use, enabling the vehicle to accommodate up to seven occupants.

The third row seats are suitable for use by older children who can either use the adult belt or a booster seat in conjunction with the adult belt. They are not suitable for smaller children who require a child seat where the adult belt is not used directly to restrain the child. Features and their availability may vary by vehicle specification. Please see page 74, or contact your nearest Land Rover Retailer, for more information.

Visit landroverusa.com to configure your vehicle online. 93

ENGINE

MODEL

COLOUR

WHEELS

INTERIOR

ACCESSORIES

TECHNICAL DETAILS



ABOVE & BEYOND

CONTENTS

SPECIFICATION

LOCATE A RETAILER

BUILD YOUR OWN

CHOOSE YOUR INTERIOR COLOR COMBINATIONS

	(A)	(B)	(C)	(D)	(E)					
COLORWAYS	EBONY / EBONY (page 97)	EBONY / LUNAR (page 97)	ESPRESSO / ALMOND (page 97)	EBONY / CIRRUS (page 98)	ESPRESSO / IVORY (page 98)					
INTERIOR COLOR										
Seat color	Ebony	Lunar	Ebony / Lunar	Espresso	Almond	Espresso / Almond	Ebony / Cirrus	Espresso	Ivory	Espresso / Ivory
Carpet	Ebony	Ebony		Espresso			Ebony	Espresso		
MODEL										
SE (grained leather)	○	–	–	–	○	–	–	–	–	–
HSE & Supercharged (perforated Oxford leather)	○	–	–	○	○	–	–	○	○	–
Supercharged with Dynamic Package (perforated Oxford leather)	○	–	–	○	○	–	–	○	○	–
HSE Dynamic & Autobiography (perforated Oxford leather with unique pattern)	○	○	○	○	○	○	–	○	○	○
SVR (perforated Oxford leather with SVR pattern)	○	–	–	–	–	–	○	–	–	–
INTERIOR FINISHERS										
Dark Satin Brushed Aluminum trim finisher	○	–	–	–	○	–	–	–	–	–
Micro Mesh Aluminum trim finisher	○	–	–	○	○	–	–	○	○	–
Sports Textured Aluminum trim finisher	○	–	–	○	○	–	–	○	○	–
Dark Engine Turned Aluminum trim finisher	○	○	○	○	○	○	○	○	○	○
Carbon Fiber veneer**	○	–	–	–	–	–	○	–	–	–
Shadow Zebrano veneer	–	–	–	○	○	○	–	○	○	○
Dark Grey Oak veneer	○	○	○	–	–	–	–	–	–	–
Grand Black veneer	○	○	○	○	○	○	–	○	○	○
EXTERIOR COLOR										
Fuji White†	○	○	○	○	○	○	▲	○	○	○
Narvik Black	○	○	○	○	○	○	○	○	○	○
Yulong White**†	▲	○	▲	○	○	○	▲	○	○	○
Indus Silver†	○	○	○	○	○	○	○	○	○	○
Corris Grey†	○	○	▲	○	○	○	▲	○	○	○
Kaikoura Stone	○	○	○	▲	○	○	○	▲	○	▲
Zanzibar	○	○	○	○	○	○	○	○	○	○
Scotia Grey†	▲	○	○	○	○	○	○	○	○	○
Aintree Green	○	○	○	○	○	○	○	○	▲	○
Estoril Blue**	▲	–	–	–	–	–	▲	–	–	–
Loire Blue	○	○	○	○	○	○	○	○	○	○
Santorini Black†	▲	▲	▲	○	○	○	○	○	○	○
Firenze Red†	▲	○	○	○	○	○	○	○	○	○
Montalcino Red	○	○	○	○	○	○	○	○	○	○
Silicon Silver*	○	○	○	○	○	○	○	○	○	○
Aruba	○	○	○	▲	○	○	○	▲	○	○
Waitomo Grey	○	○	○	○	▲	▲	○	○	▲	▲
Carpathian Grey	○	○	▲	○	○	○	▲	○	○	○
Farallon Black	○	○	○	○	○	○	○	○	○	○

▲ Combination is Designer's Choice ○ Combination is Available – Not Available.

*The availability of exterior paint colors varies by model and by time of year **Only available on SVR model †Denotes availability on SVR model.

The above table is designed as a guide. Please contact your nearest Land Rover Retailer for more information.



ABOVE & BEYOND

CONTENTS

SPECIFICATION

LOCATE A RETAILER

BUILD YOUR OWN

**STEP 5
CHOOSE YOUR INTERIOR**

	F			G		H		I		J
COLORWAYS	EBONY / IVORY (page 99)			EBONY / TAN (page 99)		EBONY / PIMENTO (page 98)		ESPRESSO / IVORY / TAN (page 98)		EBONY / LUNAR / PIMENTO (page 99)
INTERIOR COLOR										
Seat color	Ebony	Ivory	Ebony / Ivory	Tan	Ebony / Tan	Pimento	Ebony / Pimento	Espresso / Ivory / Tan		Ebony / Lunar / Pimento
Carpet	Ebony			Ebony		Ebony		Espresso		Ebony
MODEL										
SE (grained leather)	-	-	-	-	-	-	-	-	-	-
HSE & Supercharged (perforated Oxford leather)	o	o	-	-	-	-	-	-	-	-
Supercharged with Dynamic Package (perforated Oxford leather)	o	o	-	o	-	o	-	-	-	-
HSE Dynamic & Autobiography (perforated Oxford leather with unique pattern)	o	o	o	o	o	o	o	o	o	o
SVR (perforated Oxford leather with SVR pattern)	-	-	-	-	o	-	o	-	-	-
INTERIOR FINISHERS										
Dark Satin Brushed Aluminum trim finisher	-	-	-	-	-	-	-	-	-	-
Micro Mesh Aluminum trim finisher	o	o	-	-	-	-	-	-	-	-
Sports Textured Aluminum trim finisher	o	o	-	o	-	o	-	-	-	-
Dark Engine Turned Aluminum trim finisher	o	o	o	o	o	o	o	o	o	o
Carbon Fiber veneer**	-	-	-	-	o	-	o	-	-	-
Shadow Zebrano veneer	o	o	o	-	-	-	-	o	-	-
Dark Grey Oak veneer	-	-	-	o	o	o	o	-	-	o
Grand Black veneer	o	o	o	o	o	o	o	o	o	o
EXTERIOR COLOR										
Fuji White†	o	o	o	▲	o	o	o	▲		o
Narvik Black	o	o	o	o	o	o	o	o	o	o
Yulong White**†	o	o	o	▲	▲	▲	o	o	o	o
Indus Silver†	o	o	o	o	o	o	o	o	o	o
Corris Grey†	o	o	o	▲	o	o	▲	o		▲
Kaikoura Stone	o	o	o	o	o	o	o	o	o	o
Zanzibar	o	o	o	▲	▲	o	o	▲		o
Scotia Grey†	o	o	o	o	o	o	o	o	o	o
Aintree Green	o	o	o	o	o	o	o	o	o	o
Estoril Blue**	-	-	-	-	o	-	o	-	-	-
Loire Blue	o	▲	o	o	o	o	o	o	o	o
Santorini Black†	o	▲	▲	o	▲	▲	o	o	o	o
Firenze Red†	▲	o	o	-	-	▲	o	o		▲
Montalcino Red	o	o	o	-	-	o	▲	-		▲
Silicon Silver*	▲	o	o	o	o	o	o	o	o	o
Aruba	o	▲	o	o	o	o	o	▲		o
Waitomo Grey	o	o	o	o	o	o	o	▲		o
Carpathian Grey	o	o	▲	o	▲	▲	o	o		▲
Farallon Black	o	▲	o	o	o	o	o	o		o

Visit landroverusa.com to configure your vehicle online. 95

ENGINE

MODEL

COLOUR

WHEELS

INTERIOR

ACCESSORIES

TECHNICAL DETAILS



ABOVE & BEYOND

CONTENTS

SPECIFICATION

LOCATE A RETAILER

BUILD YOUR OWN

COLOR CHOICES

Each interior comes in up to three color combinations. You can use this section to place your chosen colorway within the vehicle to personalize your cabin. A choice of trim finishers is also available.



	1	2	3	4	5
COLORWAYS*	DOOR TOP	DOOR ARMREST	DOOR LOWER	INSTRUMENT PANEL UPPER	INSTRUMENT PANEL MID/ CONSOLE LID
(A) Ebony / Ebony	Ebony	Ebony	Ebony	Ebony	Ebony
(B) Ebony / Lunar	Lunar	Lunar	Ebony	Ebony	Lunar
(C) Espresso / Almond	Almond	Almond	Almond	Espresso	Almond
(D) Ebony / Cirrus (SVR model only)	Cirrus	Ebony	Ebony	Ebony	Cirrus / Ebony
(E) Espresso / Ivory	Ivory	Ivory	Ivory	Espresso	Ivory
(F) Ebony / Ivory	Ivory	Ivory	Ebony	Ebony	Ivory
(G) Ebony / Tan**	Tan (Ebony**)	Tan	Ebony	Ebony	Tan (Ebony**)
(H) Ebony / Pimento**	Pimento (Ebony**)	Pimento	Ebony	Ebony	Pimento (Ebony**)
(I) Espresso / Ivory / Tan	Ivory	Tan	Ivory	Espresso	Ivory
(J) Ebony / Lunar / Pimento	Lunar	Pimento	Ebony	Ebony	Lunar

*Steering wheel airbag cover for Autobiography with Dynamic Package will reflect colorways as per instrument panel mid and cubby lid (5)

**On Supercharged with Dynamic Package, the instrument panel mid and door top rolls are Ebony unless the Extended Leather Package is selected.



ABOVE & BEYOND

CONTENTS

SPECIFICATION

LOCATE A RETAILER

BUILD YOUR OWN

STEP 5 CHOOSE YOUR INTERIOR

AVAILABLE INTERIOR COLOR COMBINATIONS

The cabin in Range Rover Sport embodies the finest of contemporary living. The warmth of wood veneers, superb metal finishes and soft leathers combine to create a sense of home. The attention to detail is everywhere you look and in everything you touch. A wide range of color themes and seat materials is available to suit all tastes.

Interiors shown are for color reference only and are not representative of all model specification. Please refer to pages 94 to 96 for full details of availability or contact your nearest Land Rover Retailer for more information.

- A** **Ebony / Ebony** (available on SE, HSE, HSE Dynamic, Supercharged, Supercharged with Dynamic Package, Autobiography and SVR)



Interior shown: Supercharged with Dynamic Package interior in Ebony/Ebony, with Ebony seats and Micro Mesh Aluminum trim finisher, with optional Extended Leather Package.

- B** **Ebony / Lunar** (available on HSE Dynamic, and Autobiography)



Interior shown: Autobiography in Ebony/Lunar with Ebony/Lunar seats and Dark Engine Turned Aluminum trim finisher.

- C** **Espresso / Almond** (available on SE, HSE, HSE Dynamic, Supercharged, Supercharged with Dynamic Package and Autobiography)



Interior shown: Autobiography interior in Espresso/Almond, with Espresso/Almond seats and Shadow Zebrano veneer.

Visit landroverusa.com to configure your vehicle online. 97

ENGINE

MODEL

COLOUR

WHEELS

INTERIOR

ACCESSORIES

TECHNICAL DETAILS



ABOVE & BEYOND

CONTENTS

SPECIFICATION

LOCATE A RETAILER

BUILD YOUR OWN

Interiors shown are for color reference only and are not representative of all model specification. Please refer to pages 94 to 96 for full details of availability.

D Ebony / Cirrus (available on SVR only)



Interior shown: SVR interior in Ebony/Cirrus, with Ebony/Cirrus seats and Carbon Fiber veneer.

E Espresso / Ivory (available on HSE, HSE Dynamic, Supercharged, Supercharged with Dynamic Package and Autobiography)



Interior shown: Autobiography interior in Espresso/Ivory, with Espresso/Ivory seats and Dark Engine Turned Aluminum trim finisher.

H Ebony / Pimento (available on HSE Dynamic, Supercharged, Supercharged with Dynamic Package, Autobiography and SVR)



Interior shown: Autobiography interior in Ebony/Pimento, with Ebony/Pimento seats and Dark Engine Turned Aluminum trim finisher.

I Espresso / Ivory / Tan (available on HSE Dynamic, and Autobiography)



Interior shown: Autobiography interior in Espresso/Ivory/Tan, with Espresso/Ivory/Tan seats and Shadow Zebrano veneer.



ABOVE & BEYOND

CONTENTS

SPECIFICATION

LOCATE A RETAILER

BUILD YOUR OWN

STEP 5 CHOOSE YOUR INTERIOR

- F Ebony / Ivory** (available on HSE, HSE Dynamic, Supercharged, Supercharged with Dynamic Package and Autobiography)



Interior shown: Autobiography interior in Ebony/Ivory, with Ebony/Ivory seats and Grand Black veneer.

- G Ebony / Tan** (available on HSE Dynamic, Supercharged with Dynamic Package, Autobiography and SVR)



Interior shown: Autobiography interior in Ebony/Tan, with Ebony/Tan seats and Dark Grey Oak veneer.

- J Ebony / Lunar / Pimento** (available on HSE Dynamic, and Autobiography)



Interior shown: Autobiography interior in Ebony/Lunar/Pimento, with Ebony/Lunar/Pimento seats and Dark Grey Oak veneer.

Visit landroverusa.com to configure your vehicle online. 99

ENGINE

MODEL

COLOUR

WHEELS

INTERIOR

ACCESSORIES

TECHNICAL DETAILS



ABOVE & BEYOND

CONTENTS

SPECIFICATION

LOCATE A RETAILER

BUILD YOUR OWN

INTERIOR FINISHERS

Now you have chosen your interior color combination, choose one of eight interior finishers. For full availability and designer's choices, please see the color and trim matrix on pages 94 and 95.



Dark Satin Brushed Aluminum trim finisher

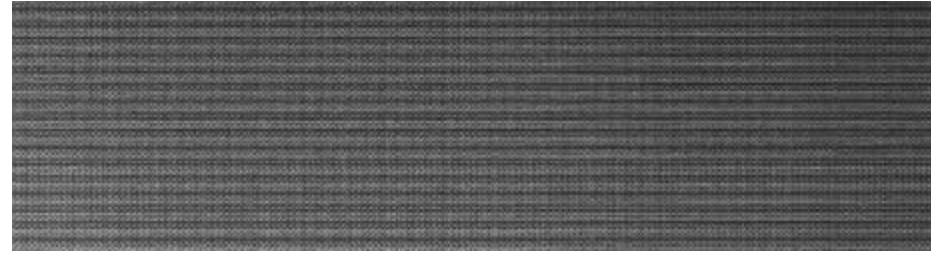

Micro Mesh Aluminum trim finisher



Sports Textured Aluminum trim finisher



ABOVE & BEYOND

CONTENTS

SPECIFICATION

LOCATE A RETAILER

BUILD YOUR OWN

STEP 5
CHOOSE YOUR INTERIOR

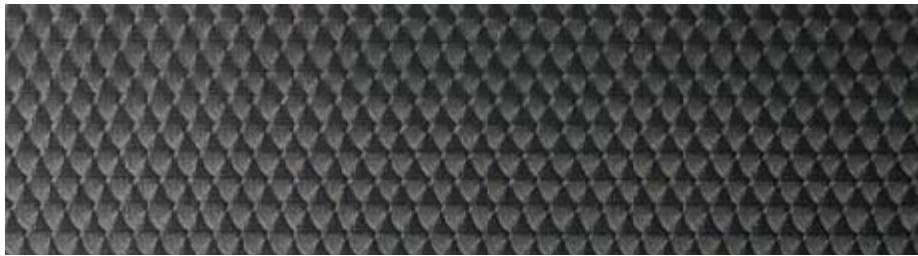

Dark Engine Turned Aluminum trim finisher



Dark Grey Oak veneer

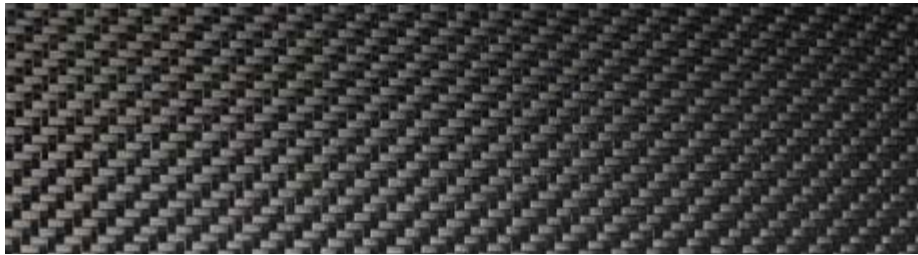

Carbon Fiber veneer (SVR only)



Grand Black veneer



Shadow Zebrano veneer

Visit landroverusa.com to configure your vehicle online. 101

ENGINE

MODEL

COLOUR

WHEELS

INTERIOR

ACCESSORIES

TECHNICAL DETAILS



ABOVE & BEYOND

CONTENTS

SPECIFICATION

LOCATE A RETAILER

BUILD YOUR OWN

6

LAND ROVER APPROVED ACCESSORIES



Some owners want to add their own stamp of individuality by tailoring their Range Rover Sport to their specific needs with a range of stylish, practical accessories that are tough, versatile and bring an opportunity for personalization to Range Rover Sport.

Importantly, these accessories can be added at any stage during the vehicle's life. Land Rover Approved Accessories are designed, tested and manufactured to the same exacting standards as the original equipment fitted to your vehicle.





ABOVE & BEYOND

CONTENTS

SPECIFICATION

LOCATE A RETAILER

BUILD YOUR OWN

STEP 6 CHOOSE YOUR ACCESSORIES

DESIGN



Stainless Steel Undershield – Front*
VPLWP0162

The off-road inspired undershield features a premium Bright Polished finish for the front of the vehicle.

Stainless Steel Undershield – Rear*
VPLWP0163 (not shown)

Stainless Steel Undershield – Rear, Tow*
VPLWP0164 (not shown)



Deployable Side Steps**

These smart, practical steps make it easier to get in and out of the vehicle. Neatly stowed under the sills, the side steps automatically deploy as soon as the door is opened, or when activated by the key fob. They stow automatically when the door is closed. The side steps are sensitive to obstructions and will not deploy in off-road or low range settings. Automatic Mode can be overridden to allow access to the roof when the doors are closed. The deployable side steps are compatible with front mudflaps and feature a stainless steel finish with laser etched Range Rover branding.



Accessory Wheels

Personalize your vehicle with a selection of alloy wheels featuring a wide range of contemporary and dynamic designs.



Mirror Covers – Carbon Fiber
VPLWB0230

High grade Carbon Fiber mirror covers, with a High Gloss finish, provide a performance-inspired premium design update.

Tailgate Trim – Carbon Fiber
VPLWB0235 (not shown)

High grade Carbon Fiber tailgate trim featuring a twill weave and a High Gloss lacquered finish, providing a performance-inspired design enhancement coupled with weight benefits associated with Carbon Fiber.



Side Vent Blades – Carbon Fiber*
VPLWB0232

High grade Carbon Fiber side power vent blades provide a performance-inspired design upgrade coupled with weight benefits associated with Carbon Fiber.

Hood Louvers – Carbon Fiber
VPLWB0231 (not shown)

High grade Carbon Fiber hood louvers provide a performance-inspired design enhancement to accentuate the distinctive Range Rover Sport profile.



Front Grille Surround – Carbon Fiber*
VPLWB0233

High grade Carbon Fiber front grille surround, with a High Gloss finish, provides a premium exterior design upgrade to highlight the dynamic capabilities and performance-inspired design of Range Rover Sport.

Fog Lamp Bezel – Carbon Fiber*
VPLWB0234 (not shown)

High grade Carbon Fiber fog lamp bezel featuring a twill weave and a High Gloss lacquered finish, providing a performance-inspired design enhancement coupled with weight benefits associated with Carbon Fiber.

*Not applicable on SVR model **Fitting of side tubes or side steps may affect the off-road capability of vehicle.

Visit landroverusa.com for more information. 103

ENGINE

MODEL

COLOUR

WHEELS

INTERIOR

ACCESSORIES

TECHNICAL DETAILS



ABOVE & BEYOND

CONTENTS

SPECIFICATION

LOCATE A RETAILER

BUILD YOUR OWN

TOURING



Luggage Roof Box**
VPLVR0062

Roof mounted luggage box with Gloss Black finish. Opens from both sides and is lockable for security. Includes power-grip mounting for easy and quick fixing to the roof bars. External dimensions: 68.9 inches long, 32.3 inches wide, 17.7 inches high. Volume 14.5 cu.ft. Maximum payload 165lbs**.



Sports Roof Box**
VPLVR0061

Sleek, aerodynamic design sports roof box with a Gloss Black finish which can be mounted on either side of the vehicle. Internal retention system for skis or other long loads. Lockable for security. External dimensions: 81.1 inches long, 33 inches wide, 13.4 inches high. Internal volume 11.3 cu.ft. Load capacity 165lbs.

Large Sports Roof Box*
VPLWR0100 (not shown)



Luggage Carrier**
LR006848

Flexible rack system to facilitate roof carrying. Maximum payload 165lbs**.



Tow Bar Receiver
VPLWT0150

This bespoke system has been optimized alongside the Range Rover advanced aluminum chassis construction. Approved for up to 7,716lbs trailer load.

Trailer Hitch Kit (VPLWY0083) and Towing Electrics Kit are available separately.

Dark Atlas Bumper Fitting Kit VPLWB0136
Light Atlas Bumper Fitting Kit VPLWB0139
Gloss Black Bumper Fitting Kit VPLWB0137



Towing Electrics
VPLWT0115

These handy sockets are mounted conveniently in your vehicle's rear bumper, providing the electrical power needed for rear lighting on your trailer. Must be used with Trailer Hitch Kit.



Collapsible Luggage Organiser
VPLVS0175

Collapsible loadspace organiser keeps items from shifting during transport. Comes with two durable straps to clip to the lashing eyes and can be easily folded away when not in use.



Center Armrest Cooler/Warmer Box
VPLVS0176

Food and drinks chiller and warmer that acts as a rear center armrest. With a leather-covered top, it is held in place by the center seat belt and powered from the rear auxiliary socket. Ideal for long journeys with the family.

*Roof rails and cross bars are required for all Land Rover roof mounted accessories. Objects placed above the roof mounted satellite antenna may reduce the quality of the signal received by the vehicle and could have a detrimental effect on the navigation and satellite radio system, if fitted **Maximum payload equals the load capacity of the roof mounted accessory *Some roof carrying accessories may restrict opening of the vehicles sliding sunroof when fitted. Care should be taken when opening the roof to avoid collision with any items fitted above the vehicle.



ABOVE & BEYOND

CONTENTS

SPECIFICATION

LOCATE A RETAILER

BUILD YOUR OWN

STEP 6 CHOOSE YOUR ACCESSORIES

SPORTING



Aqua Sports Carrier**
VPLGR0107

Carries one surfboard, sailboard, canoe or kayak. Includes lockable multi-purpose holder to carry a mast, oars or paddles. Tilts to facilitate easy loading/unloading. Features lockable straps and rubber supports to maintain optimum weight distribution while protecting the kayak and vehicle from scratches/scuffs. Maximum load capacity 99lbs.



Aqua Sports Carrier – 2 Kayaks**
VPLWR0099

Carries two kayaks or canoes. Also suitable for transporting surfboards or paddle boards. Includes lockable multi-purpose holder to carry paddles. Tilts to facilitate easy loading/unloading.



Ski/Snowboard Carrier**
LR006849

Carries four pairs of skis or two snowboards and incorporates slider rails for easy loading, is also lockable for security. Maximum payload 79lbs**.

Ski Bag
VPLGS0166

The Land Rover padded ski/snowboard bag carries up to two pairs of skis and poles up to 70.9 inches long. It is manufactured from durable 600D polyester and features removable shoulder straps.



Roof Rails*

Roof rails facilitate easy fitment of cross bars for roof carrying. Pre-set positioning points ensure cross bars are fixed in optimum position for weight distribution and dynamics.

Cross Bars*
VPLGR0102

Elegant, durable Bright finish aluminum cross bars, with T-track design which utilizes the full length of the bars, providing space to mount multiple accessories. Aerodynamic profile minimises drag and wind noise. The incremental height when fitted is 3.5 inches.



Loadspace Liner Tray
VPLWS0224

Semi-rigid waterproof loadspace liner tray with a raised lip on three sides to protect loadspace floor and side wall carpets from dirty or wet equipment.

Visit landroverusa.com for more information. 105

ENGINE

MODEL

COLOUR

WHEELS

INTERIOR

ACCESSORIES

TECHNICAL DETAILS



ABOVE & BEYOND

CONTENTS

SPECIFICATION

LOCATE A RETAILER

BUILD YOUR OWN

OUTDOOR



Loadspace Retention Kit
VPLGS0171

The loadspace retention kit consists of a package of attachments that fix into the loadspace rails via a quick lock/quick release system to help provide a comprehensive and flexible solution for retaining luggage and other items within the loadspace. The attachment package includes a retractable flexible strap with inertia reel, telescopic rod and stowage bag.

Loadspace mounted rails to help increase the flexibility of loadspace stowage, also allowing the fitment of the luggage retention kit stowage system.

Loadspace Rails
VPLWS0242 – 5 Seat
VPLWS0243 – 5 + 2 Seat



Loadspace Rubber Mat
VPLWS0225

Range Rover branded waterproof rubber mat with retaining lip, helps protect the rear loadspace carpet from general dirt.



Luggage Partition – Full Height
VPLWS0235

Designed to protect vehicle occupants against the displacement of luggage. Following initial retailer installation the luggage partition can be easily removed with appropriate fitting tool.

Luggage Partition – Half Height
VPLWS0236 (not shown)

Luggage Partition Divider
VPLWS0237 (not shown)



Fixed Side Steps*
VPLGP0226

Complete with a rubber tread mat and brushed stainless steel trim, the fixed side steps provide easy access/exit to the vehicle's cabin and aids access to the roof. With embossed Range Rover branding, exterior Bright work and Bright Anodised Aluminum edge trim finish, they complement vehicle exterior design cues.



Rubber Mats – LHD
VPLWS0190

Rubber footwell mats for front and second row occupants helps provide protection from general dirt. Branded and with Bright accent Range Rover ingot and durable metal corner piece to the external edge.



Mudflaps – Front
VPLWP0165

Mudflaps – Front, with Deployable Side Steps
VPLWP0167 (not shown)

Mudflaps – Front, SVR (not shown)**
VPLWP0222



Mudflaps – Rear
VPLWP0166

Mudflaps – Rear, SVR (not shown)
VPLWP0221

Mudflaps are a popular upgrade for reducing spray and ensuring paintwork is protected from debris and dirt. Designed to complement vehicle exterior design.

ENGINE

MODEL

COLOUR

WHEELS

INTERIOR

ACCESSORIES

TECHNICAL DETAILS



ABOVE & BEYOND

CONTENTS

SPECIFICATION

LOCATE A RETAILER

BUILD YOUR OWN

STEP 6 CHOOSE YOUR ACCESSORIES

OTHER



Loadspace Retention Net
VPLMS0302

Secure small items and luggage within loadspace. Utilizes loadspace tie-down points. Includes floor net and two ratchet straps which are approximately two meters long.



Sill Treadplates – Illuminated, Vehicle Set
VPLWS0208

Illuminated treadplates with Range Rover script and halo surround. Rear treadplates feature illuminated halo only.



Sill Treadplates – Personalized, Illuminated, Front, Pair
VPLWS0212

Personalized illuminated treadplates allows you to choose a personalized message using an approved set of fonts/typefaces which will be highlighted in white illumination when the front doors are open.

Sill Treadplates – Personalized, Illuminated, Vehicle Set
VPLWS0209



iPad® Holder – 1*
VPLVS0164

iPad® holder with Land Rover branding, mounts securely to the rear of the front seat head restraint posts to face rear seat. Features quick release design allowing iPad® to be fitted/removed quickly and easily.

iPad® Holder – 2 and onwards*
VPLVS0165



Seat Back Stowage†
VPLVS0181

Provides convenient stowage solution for the rear of the front seats with multiple compartments for stowing small items.

Seat Back Stowage – Premium Leather†
VPLVS0182



Gearshift Paddles – Aluminum
VPLVS0187MMU

Complete the look and feel of your steering wheel with premium aluminum paddles. Gearshift paddles are machine polished, anodized and hand brushed to provide exceptional wear resistance with a premium finish.

Gearshift Paddles – Aluminum Red
VPLVS0187CAY

*Not compatible with 10" Rear Seat Entertainment. Not available on SVR model †Not compatible with 10" Rear Seat Entertainment. iPad® is a registered trademark of Apple Inc., registered in the US and other countries.

Visit landroverusa.com for more information. 107

ENGINE

MODEL

COLOUR

WHEELS

INTERIOR

ACCESSORIES

TECHNICAL DETAILS



ABOVE & BEYOND

CONTENTS

SPECIFICATION

LOCATE A RETAILER

BUILD YOUR OWN

DIMENSIONS AND CAPABILITIES

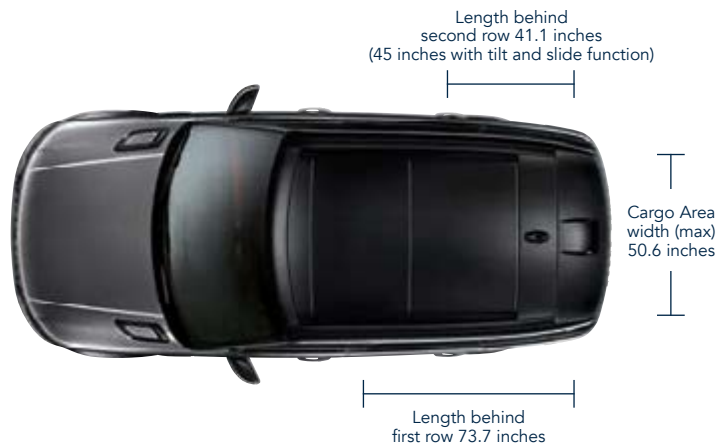

Standard Ride Height

With roof rails 70.1 inches
 With roof antenna 70.9 inches
 With panoramic roof open 71.5 inches
 Access height air suspension setting will reduce each of the above by 2 inches

Headroom

Maximum front headroom with panoramic roof 39.4 inches
 Rear headroom 39.1 inches

Legroom

Maximum front legroom 42.2 inches
 Maximum rear legroom 37 inches

Cargo Capacity

Rear seats upright
 Height 30.2 inches, Width 50.6 inches
 Cargo volume 27.7 cu.ft.
 Cargo width between arches 44.1 inches
 Length at floor 41.1 - 45 inches
 Rear seats folded
 Height 30.2 inches, Width 50.6 inches
 Cargo volume 62.2 cu.ft.
 Cargo width between arches 44.1 inches
 Length at floor 73.7 inches

Obstacle Clearance

Off-road height 11.3 inches*
 Standard ride height 8.4 inches

Turning Circle

Curb-to-curb 40.6 feet
 Wall-to-wall 41.0 feet
 Turns lock-to-lock 2.7

Wading Depth**

Maximum wading depth 33.5 inches

Width 81.6 inches mirrors folded
 Width 87.4 inches mirrors out



Front wheel track 66.5 inches



Rear wheel track 66.3 inches



	A	B	C
Ride Height	Approach Angle	Ramp Angle	Departure Angle
Off-road (SVR)*	33.0° (30.0°)	27.2° (27.0°)	31.0° (27.3°)
Standard (SVR)	24.3° (22.4°)	19.4° (19.4°)	24.9° (22.5°)



Wheelbase 115.1 inches



ABOVE & BEYOND

CONTENTS

SPECIFICATION

LOCATE A RETAILER

BUILD YOUR OWN

TECHNICAL DETAILS

TECHNICAL SPECIFICATION, PERFORMANCE AND KEY DATA

	DIESEL	GAS			
	3.0L Td6	3.0L SUPERCHARGED V6	3.0L SUPERCHARGED V6	5.0L SUPERCHARGED V8	5.0L SUPERCHARGED V8 (SVR)
POWER (HP)	254	340	380	510	550
ENGINE DATA					
Bore (inches)	3.31	3.33	3.33	3.64	3.64
Stroke (inches)	3.54	3.50	3.50	3.66	3.66
Compression ratio (:1)	16.1	10.5	10.5	9.5	9.5
BRAKES					
Front type	Ventilated disc	Ventilated disc	Ventilated disc	Ventilated disc	Ventilated disc
Front diameter (inches)	14.17	14.17	14.96	14.96	14.96
Rear type	Ventilated disc	Ventilated disc	Ventilated disc	Ventilated disc	Ventilated disc
Rear diameter (inches)	13.78	13.78	14.37	14.37	14.37
Park Brake	Electric Park Brake (EPB) integrated into brake caliper		Electric Park Brake (EPB) integrated into brake caliper		
WEIGHTS (lbs)					
Weight	4,698	4,658	4,658	5,084	5,137
Maximum laden weight (5 seat / 5 + 2 Seating)	6,614 / 6,945	6,614 / 6,900	6,614 / 6,900	6,834 / 7,165	6,614
Maximum mass on each axle (front)	3,306	3,306	3,306	3,306	3,306
Maximum mass on each axle (rear) (5 seat / 5 + 2 Seating)	3,913 / 4,188	3,905 / 4,180	3,913 / 4,188	3,913.2 / 4,188	3,913
TOWING (lbs)					
Unbraked trailer	1,654	1,654	1,654	1,654	1,654
Maximum towing	7,716	7,716	7,716	7,716	6,614
Maximum tongue weight**	771	771	771	771	771
Maximum vehicle and trailer combination / Gross Train Weight (5 seat / 5 + 2 Seating)	14,330 / 14,660	14,330 / 14,616	14,330 / 14,616	14,550 / 14,881	13,227
ROOF CARRYING (lbs)					
Maximum roof load (including roof rails)	220	220	220	220	220
PERFORMANCE					
Maximum speed (mph) [†]	130	130	130	130	162
Acceleration (secs) 0-60mph [†]	7.1	6.9	6.8	5.0	4.5
Fuel tank capacity – usable (gallons)	22.7	27.7	27.7	27.7	27.7
Diesel Particulate Filter (DPF)	■	-	-	-	-

■ Standard – Not Available.

*Only available on Dynamic Package models **Maximum tongue weight when vehicle is at maximum laden weight is 330lbs †Always follow local speed limits.

Official EU Test Figures. For comparison purposes only. Real world figures may differ.

Visit landroverusa.com for more information. 109

ENGINE

MODEL

COLOUR

WHEELS

INTERIOR

ACCESSORIES

TECHNICAL DETAILS



ABOVE & BEYOND

CONTENTS

SPECIFICATION

LOCATE A RETAILER

BUILD YOUR OWN

A WORLD OF LAND ROVER



LAND ROVER EXPERIENCE

Ever since its inception, Land Rover has been ready for anything. Its legendary capability has seen it tackle the most demanding of terrains, in the most difficult conditions. Its versatile interior has become synonymous with comfort and greater loadspace. And its 'can do' attitude has made it the most welcome of vehicles across the globe.

You can be part of the Land Rover story at one of our Land Rover Experience Centers. You can see how each and every one of these iconic vehicles is built. You can take one out onto off-road tracks where your driving skills will be put to the test. Or you can go even further on one of our Adventure Travel holidays to such countries as Tanzania, Iceland or Morocco.

Adventure awaits.

For more information, visit landroverusa.com



LAND ROVER ONELIFE

Onelife, the award-winning Land Rover magazine, is published twice a year and reaches customers in 40 countries. Each issue is filled with the latest Land Rover news and vehicles, insights into the technology and design that shape each vehicle, inspirational journeys and opinions from international experts.



LAND ROVER FINANCIAL SERVICES

Getting the keys to your very own Land Rover has never been so simple. And it's more affordable than you might think. New or used, for personal or business use, we have an option that puts you in complete control. Please speak to your nearest Land Rover Retailer to find out more.

FLEET & BUSINESS

Land Rover is dedicated to being the premium manufacturer of choice for fleets and businesses, by providing a highly attractive range of vehicles and exemplary customer service.

Distinctive, capable and versatile, all Land Rover vehicles deliver low total cost of ownership through strong residual values, competitive service, maintenance and repair costs.

We are also committed to providing a totally customer-focused aftersales service, which will ensure every Land Rover vehicle is kept on the road and in top condition, in the easiest and most cost-efficient way for businesses.

For more information, visit landroverusa.com





ABOVE & BEYOND

CONTENTS

SPECIFICATION

LOCATE A RETAILER

BUILD YOUR OWN



LAND ROVER COLLECTION

The vehicle is just the beginning. The latest Land Rover Collection is now available for you to discover.

A meticulous attention to detail doesn't stop with our vehicles. You'll find the same level of craftsmanship in all of our clothing, travel items and premium gift ideas. So whether you're shopping for yourself or a loved one, you know the quality is assured.

The Land Rover Collection includes ladies and gents clothing, an extensive range of small leather goods such as wallets, portfolios, iPad and iPhone cases along with briefcases and weekender bags. A range of cufflinks and ladies silk scarves add a luxury feel to the collection. There's a kids collection too, with colorful fun clothing, caps and replica model vehicles for them to enjoy.

Visit shop.landroverusa.com to browse the latest Land Rover Collection.



ROADSIDE ASSISTANCE

Land Rover Roadside Assistance provides assistance in motoring emergencies, from immobilization due to breakdown or accident to minor problems such as punctures. You can rely on our roadside assistance, whatever the situation, anywhere in North America during the vehicle warranty period.

For further details please contact your nearest Land Rover Retailer or visit landroverusa.com

IMPORTANT NOTICE: Jaguar Land Rover Limited is constantly seeking ways to improve the specification, design and production of its vehicles and alterations take place continually. While every effort is made to produce up to date literature, this brochure should not be regarded as an infallible guide to current specifications, nor does it constitute an offer for the sale of any particular vehicle. Distributors and Retailers are not agents of Jaguar Land Rover Limited by any express or implied undertaking or representation.

All Land Rover Approved Accessories fitted by a Land Rover Retailer within one month or 1,000 miles (which ever occurs first) of the handover of a new registered vehicle will benefit from the same warranty terms and period of cover as the vehicle warranty. Accessories purchased outside of these parameters will be subject to a 12 month unlimited mileage warranty. All Land Rover Approved Accessories are rigorously tested to the same exacting standards as those applied to our vehicles. Performance in extreme hot and cold temperatures, corrosion resistance, impact and airbag deployment highlight some of the exhaustive product testing carried out to ensure accessories are both durable and importantly, continue to comply with current legislation. Some of the accessories featured are not available on all models. Please consult your nearest Land Rover Retailer for more information.

All our accessories are designed to be an integral part of Land Rover vehicles. While many items such as roof carriers are simple to fit, some products require specialist tools and diagnostic equipment to ensure correct integration with the vehicle structure and electrical systems. These products vary from market to market, please consult your Land Rover Retailer who will be pleased to advise you on current specifications and any query you may have.

The colors reproduced here are subject to the limitations of the printing process and may therefore vary slightly from the actual vehicle. The company reserves the right to alter or withdraw any color finish without notice. Some of these colors may not be obtainable in your country. Please check availability of colors and current specifications with your Land Rover Retailer. Distributors and retailers are not agents of Jaguar Land Rover Limited and have absolutely no authority to bind Jaguar Land Rover Limited to any express or implied undertaking or representation.

Castrol EDGE Professional recommended by Land Rover.

Vehicle shown on front and back covers is Supercharged with Dynamic Package in Indus Silver with optional wheel.



Jaguar Land Rover North America, LLC

555 MacArthur Boulevard
Mahwah, NJ 07430

1-800-FIND-4WD

landroverusa.com

© 2016 Jaguar Land Rover North America, LLC.
Publication Number: LRML 5253/16





ABOVE & BEYOND

CONTENTS

SPECIFICATION

LOCATE A RETAILER

BUILD YOUR OWN

