

2018 Chrysler 300

Bold design dedicated
to making a statement.



IMPORTED FROM DETROIT®



Classic and modern design advances trend. The Chrysler 300 stands the test by standing by a distinctive lineage of power, luxury and everlasting style. Confident without conceit, it's a machine of the ages for the sophisticated and discerning driver. One who recognizes worth, understands design and appreciates dynamic performance. Some call it maturity. You'll know it's premium — everything. It's time to show the world what you're made of.

Style personified.

Each stunning Chrysler 300 model embodies attainable craftsmanship and advanced technology. The lineup is tailored with available leather interiors and offerings like an advanced automatic available All-Wheel-Drive (AWD) system, a V6 or V8 engine with a class-exclusive* standard rotary e-shift 8-speed transmission, and enhanced fuel efficiency. Finished in statement-making appointments, the 300 design echoes your assured sense of accomplishment.



Details matter.

Dynamic and enduring architecture serves a myriad of purposes bearing a strong connection to overall design, function and surroundings. The Chrysler 300 takes its proper place at the top, delineating a solid and seamless flow the driver feels. The trademark grilles pay tribute to the bold shape and admirable platform of attitude that can only be attributed to one nameplate.

Promote yourself at every occasion.

The best of American aspiration delivers attributes like 363-V8 available horsepower, mission-focused aerodynamic design, and the ultimate in premium interior materials, technology and roominess of a full-size sedan — making the 300C impeccably luxurious. The sculpted 300 exterior reveals a head-turning profile complemented by a modern, athletic silhouette that's always dressed to impress.



The luxury of timeless elegance.

Chrysler 300C



Advanced All-Wheel-Drive (AWD) system.

This available advanced AWD system detects wheel-slip and kicks in before you even realize you need it by automatically distributing power between front and rear wheels. The system also engages when the driver turns off the Electronic Stability Control (ESC)² system or when the steering-wheel paddle shifters are in use. In cases of inclement weather, AWD is tuned to minimize oversteer and maximize traction where snow, ice, mud, sand and/or gravel are present.

Automatic front-axle disconnect.

The available front-axle disconnect gives you the ultimate in performance and traction when you need it, and optimized fuel economy when you don't. As a function of the available AWD system, power is completely removed from the front wheels when Rear-Wheel-Drive (RWD) performance is sufficient, such as on dry surfaces, allowing for an increase in fuel efficiency. There is no need to select RWD or AWD, as the proper mode is engaged when necessary, depending on the road surface and factors such as aggressive starts and dynamic driving.



Leave the rookies behind.

Through the evolution of the legendary 300 collection, its innate strength and stunning shape remain true. The uniquely square, chiseled face features premium chrome applications symbolizing engineering brilliance and innovation in its construction. Framing the signature lighting, wing badge and grille designs, the fascia hardware leads the visual continuity that is undeniably Chrysler.

4-wheel independent suspension makes rough roads ride smoothly.

You will immediately notice the superior driving dynamics and premium ride and comfort, even on not-so-smooth roads. The optimally tuned multilink suspension, premium shock absorbers and rear stabilizer bar deliver calibrated road-surface handling during cornering and over bumps. Multiple bushings designed with first-rate construction materials help reduce road noise, vibration and harshness (NVH) to deliver a smooth, quiet ride, and the electric power steering system contributes to increased fuel efficiency while providing exceptional feel and feedback.

Sustained to attain

A symphony of power and efficiency.

For maximum power, choose the legendary 5.7L HEMI® V8 Variable Valve Timing (VVT) engine with Fuel Saver Technology, available on the Rear-Wheel-Drive (RWD) versions. Delivering the power of an eight-cylinder engine with the efficiency of a four-cylinder, this technology detects when full power isn't necessary, such as at highway cruising, and deactivates four of the eight cylinders for improved efficiency. It produces best-in-class¹ 363-V8 horsepower and 394 lb-ft of torque along with an EPA estimated 16 city/25 hwy mpg.* Thanks in part to the TorqueFlite® 8-speed transmission, you'll get the perfect formula for power and value.

Class-exclusive¹ rotary e-shift 8-speed transmission.

The standard 8-speed transmission provides optimal fuel efficiency with full-power performance. It starts with the acclaimed 3.6L Pentastar® V6 engine with up to 300 horsepower and arms it with eight speeds to yield up to an EPA estimated 19 city/30 hwy mpg.†

The class-exclusive¹ standard Satin Chrome-finished rotary e-shifter, located on the integrated center console, electronically selects gears for a smooth, lightweight automatic shift experience.

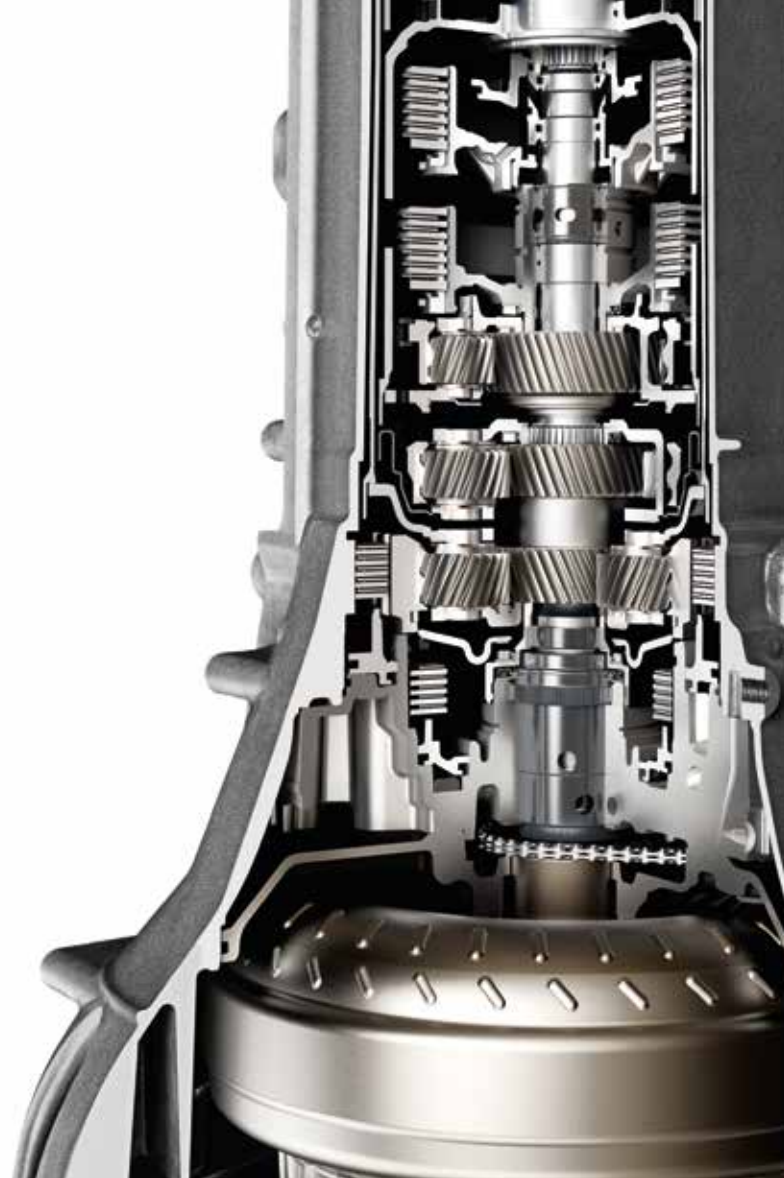
**Best-in-class¹ V6 driving range.**

With the Chrysler 300S model's dual-exhaust system accompanying the standard 3.6-liter DOHC Pentastar® VVT V6 engine and 8-speed transmission, it produces an astounding 300 horsepower and 264 lb-ft of torque. Standard on Chrysler 300 Touring, 300 Touring L and 300 Limited, the V6 8-speed powertrain delivers 292 horsepower and 260 lb-ft of torque. It provides an exceptional blend of high torque, fuel efficiency, low emissions and first-rate noise, vibration and harshness (NVH) control, along with up to an EPA estimated 19 city/30 hwy mpg.†

300S commands 300 horsepower
with up to 30 hwy mpg¹





Performance 10

The S factor.

Like stepping into your favorite black leather boots, the 300S gives drivers an edge when it comes to attitude. Black headlamps and fog lamp bezels, 20-inch wheels, Black LED taillamps, Black Chrome surround grille, and Gloss Black DLO make a slightly sinister statement. The expression synchronizes with the interior's available premium, perforated leather performance seats with high-bolstered contours in suede, providing more lateral support during spirited driving. With 300 available horsepower from the V6 engine, Sport mode and a performance-tuned suspension, the swagger is more than skin deep.

Designed to move you.

BeatsAudio™ technology translates countless hours of experience in the studio working with world-class musicians into a unique blend of artistry and tuning for vehicle sound quality. BeatsAudio 10-speaker system plus subwoofer, available on 300S.



Some families prefer to play it cool, while they keep it real.

Spaciousness means more than physical comfort for a family of five in the Chrysler 300. The 60/40 split rear bench seat, cup holders, rear A/C vents and available heated seats, as well as access to USB ports allow a welcoming environment for backseat passengers. The beauty and feel of premium materials and ergonomically designed seats including LATCH child seat anchors help the driver and passengers alike, find a personal space to call their own. An available dual-pane panoramic sunroof, which extends to the backseat, offers a moonlit vibe to nighttime outings, while the available power sunshade puts backseat naps back on the schedule.

Work to live

Opposite page: 300S interior shown in Black Nappa leather with Light Diesel stitching. This page: 300S shown in Bright White.



Zero to sixty in less than six.

There's a reason some prefer to take charge on the road and the most powerful V8 in its class¹ with the available 5.7L HEMI[®] V8 engine gets it. The best-in-class¹ 363 heavyweight V8 horsepower and the surprising punch of 394 lb-ft of torque add up to acceleration that more than meets the demands of the get-ahead driver. With a 0 – 60 time at 5.8 seconds and an astounding 1/4-mile time of 14.2 seconds, there is no room for doubt behind the wheel. For a more athletic attitude that demands being at the front of the pack, the 300S V8 includes the S Model Appearance Package, which adds a more aggressive SRT[®] front fascia, unique SRT LED fog lamps, sculpted side sills and the SRT deck-lid spoiler.

Spur on the Sport dynamics.

The Sport mode on 300S delivers enhanced steering and throttle feedback, stability control and transmission shifts, and more aggressive available All-Wheel-Drive (AWD) performance. When in Sport mode, paddle shifters can be used to shift gears as the Electric Power Steering Sport Performance is activated.



300S puts the driver back into driving



Position of authority.

The leather-wrapped and available heated steering wheel provides advanced ergonomic grip, cruise settings, hands-free³ phone controls and available performance-driving Sport mode paddle shifters. The three-spoke design invites a clear view to the gauges and 7-inch Driver Information Display (DID). An available two-tone premium Nappa leather-wrapped, stitched and real wood, tilt/telescoping-column steering wheel with a chrome tracer ring brings a feeling of luxury to your hands. The advanced EPS offers Normal, Comfort and Sport modes for more responsive steering, as well as feedback for spirited driving.

Warmth to hold on to.

Because waiting for heat isn't an option on cold mornings — the available heated steering wheel delivers immediate warmth operated via the Uconnect[®] touchscreen display. With the available Remote Start⁴, the heated steering wheel can be programmed to activate automatically when temperatures outside dip below 40°F.

Coat of arms.

The emblem-worthy interior boasts seat features that include available leather-trimmed, heated front and rear seats, and available front-seat ventilation. The available rich, deep-quilted Linen leather-trimmed seats with Linen stitching and quilted door bolsters are the hallmark of the 300C model. Recline in the comfort of premium perforated Nappa leather-trimmed seats. Matte-finish Mocha real wood adds warm accents along with the heated two-tone leather-wrapped steering wheel and leather-wrapped dash.



Designed for the driven

Appreciate the performance from the best seats in the house.

Every sense awakens as you slip into the smooth, stately interior. The available leather-wrapped and accent-stitched seating, instrument panel, doors and center console, real wood accents, heated and cooled front-console cup holder, and generous leg and head room reveal the level of sophistication for you and your passengers' ergonomic pleasure. An available dual-pane panoramic sunroof, which extends to the backseat, brings further magnificence to the 300C interior experience.

Just right, every time.

The driver and front-passenger seats have two heat settings and may be ventilated for faster cooling in warmer weather. The available Remote Start⁴ feature allows the driver's heated seat to be programmed to automatically activate if outside temperatures are below 40°F, while cooling ventilation activates above 80°F.

Instrumental collaboration to keep you in key.

An available premium audio 276-watt system makes any commute pleasant. The six-speaker sound system incorporates high-performance, injection-molded woofers, including two 3.5-inch speakers located in the instrument panel, and two 6x9-inch speakers located in the front doors, as well as in the rear shelf.



Sound your on-board specialists will approve.

With the available Harman Kardon[®] premium audio system, every seat is perfectly tuned by sound specialists to immerse you in multichannel surround sound with up to 19 speakers in 13 locations — providing a life-like audio experience.

Acoustic perfection: the impressive 19-speaker Harman Kardon audio system.

Available on 300 Limited and 300C, the system is tailored to provide the driver and passengers with the ultimate music playback realism, maximizing the sound stage experience from any seating position.

Well-known in the world of high-end audio, Harman Kardon gives you a clear, powerful audio experience that delivers:

- GreenEdge™ unity coaxial mid-range speakers with integrated tweeters
- Harman Kardon GreenEdge subwoofers
- 12-channel, Class D amplifier with 35-volt tracking power and Logic 7[®] surround-sound processing

harman/kardon[®]

Cruising perks.

Centrally located control buttons on the steering wheel provide ease of operation for the standard Uconnect® 4C with 8.4-inch touchscreen, as well as the audio, voice and speed controls. The cruise settings include the available Adaptive Cruise Control (ACC) with Stop,⁵ which allows you to select one of four distance increments behind other vehicles.

7-inch Driver Information Display (DID).

Personalize the information you want to see. The full-color DID in the instrument cluster seamlessly integrates crisp, configurable graphics with analog instruments. The distinctive Sapphire Blue-ambient display allows for a wide range of settings, including audio, speed, compass, temperature, fuel economy, trip, cruise control, vehicle status and engine performance, all adding up to over 7,000 available driver configurations.



SiriusXM® All Access Package⁶ Get over 160 channels on your radio, including premium programming and Instant Replay to pause, replay, rewind and fast-forward programs. One-year trial.

SiriusXM⁶ on the App and Online. Stream SiriusXM⁶ beyond your car. Go to siriusxm.com/getallaccess for more information.

SiriusXM Traffic Plus⁶/SiriusXM Travel Link⁶ Get detailed information on traffic, construction, road closures and more, as well as weather forecasts, fuel prices, sports scores and movie schedules.

SiriusXM Guardian⁷ Connected Vehicle Services. With services like SOS Call,⁸ Roadside Assistance Call,⁹ Remote Vehicle Start,⁴ Vehicle Finder,¹⁰ Stolen Vehicle Assistance,¹¹ it keeps you safely connected.

Uconnect® Phone. Pair a Bluetooth® enabled phone with Uconnect by simply pressing the steering-wheel Phone button and following the prompts. Then send and receive calls hands-free.³ Do Not Disturb: Route incoming calls to voice mail, hold texts, provide visual prompts of calls/texts and send an automated reply.

Voice Recognition. Select radio stations, SiriusXM⁶ channels and navigation destinations, and make calls and record voice memos. The system can be trained to recognize your voice and understand English, French and Spanish.

One-step Navigation. Available Uconnect 4C NAV with 8.4-inch display radio systems with navigation includes 3D city and landmark imaging, digital terrain maps, enhanced screen graphics and one-step voice destination entry.

Climate. Interior temperature and climate settings, heated seats, steering-wheel buttons and mirror dimmer can be controlled via the 8.4-inch touchscreen, as well as voice activation.

Drag and Drop Menu Bar. Personalize the dashboard with your top six features and services.

Uconnect®

Choice, connection and harmony.



Uconnect 4G Wi-Fi¹² is the traveling hotspot.

Securing the perfect location to get online is simple with a built-in hotspot that uses the antenna of your Chrysler 300 to connect to your personal Wi-Fi¹² account. And with the AT&T® nationwide network, you're always connected to fast reliable Internet speed for up to 8 devices and within 50 feet of your vehicle.

Android Auto^{TM13}

Automatically provides a safer way to use AndroidTM while driving, sharing information while you easily access the best of Google: Maps with voice-guided navigation and Play Music; place phone calls or send and receive messages¹⁴ and ask Google Search any question by voice command.⁵

android
auto

Apple CarPlay^{TM15}

A smarter, safer way to use an iPhone® inside your vehicle and seamlessly integrate it with the Uconnect touchscreen and Siri^{®16} voice control. You can make calls, access music, send and receive messages,¹⁴ get directions optimized for traffic conditions and more while staying focused on the road.

Works with
Apple CarPlay

80+ standard and available safety and security features.



Safety cage/air bag¹⁷ deployment

Solid framework.

The body frame utilizes advanced high-strength steels for outstanding occupant protection in the event of front, side or rear impact. The front and rear crumple zones are strategically formed structural sections that crumple and absorb energy in a collision, helping to protect the occupant cabin.

Equipped to protect.

The standard air bags¹⁷ include front dual-stage air bags¹⁷ with adaptive venting technology, driver knee air bag¹⁷ as well as supplemental front-seat-mounted side-impact air bags¹⁷ and supplemental side-curtain air bags¹⁷ which extend over front and rear-outside seating rows. Advanced multistage low-risk deployment front air bags¹⁷ incorporate adaptive venting technology, which delivers varying levels of deployment based on occupant size and impact severity.

Electronic Stability Control (ESC)² reacts automatically.

In the event of a sudden, unexpected traction loss, it's human nature to overcompensate for the loss of control by pulling the steering wheel too much in the opposite direction of the vehicle's sway. Fortunately, the standard ESC² features dynamic directional control and stability measures in various driving conditions. The system automatically activates when steering-wheel angle differs or is inconsistent with the vehicle orientation, reducing throttle input and selectively applying brakes to counteract oversteer or understeer.



Rain Brake Support.

In rainy conditions, this standard mechanism will occasionally push the brake pads lightly against the rotors to keep them dry. Likewise, Ready Alert Braking anticipates when the driver may initiate an emergency brake stop and uses the ESC² pump to set brake pads against rotors, decreasing time required for full braking.

Rain-sensing wipers.

An available convenience feature that automatically senses moisture on the windshield and activates the wipers.

Adaptive Forward Lighting (AFL).

This available system adjusts headlight beams up to 15 directional degrees left or right depending on which direction the driver is turning the vehicle.

Brake Assist.

By applying maximum braking power in emergency braking situations, this available feature minimizes stopping distance.

Automatic headlamps.

The standard headlamps turn on and off automatically depending on exterior light levels and whether or not windshield wipers are operating.

LED visual reinforcements.

Even on a clear day or night, being seen in the distance by drivers behind you is as imperative as clearly seeing the road and vehicles ahead. The standard LED taillamps provide distinct illumination along with brake, stop and running light functions, ensuring light output is consistent throughout the taillamp. The available LED fog lamps provide improved illumination during inclement weather, without obstructing the view of oncoming traffic.

Expand your space and time.

[A] Blind Spot Monitoring¹⁸ — Sees where you can't.

This available system continuously monitors rear blind zones on either side of your vehicle via radar. If a vehicle is sensed in the zones, audible chimes will alert you, as well as a yellow triangle symbol on the outside rearview mirror. Available Rear Cross-Path Detection¹⁹ monitors for vehicles/objects in perpendicular relationships to your vehicle when maneuvering backward in parking lots, and provides feedback to you by audible chimes and/or visual icons.

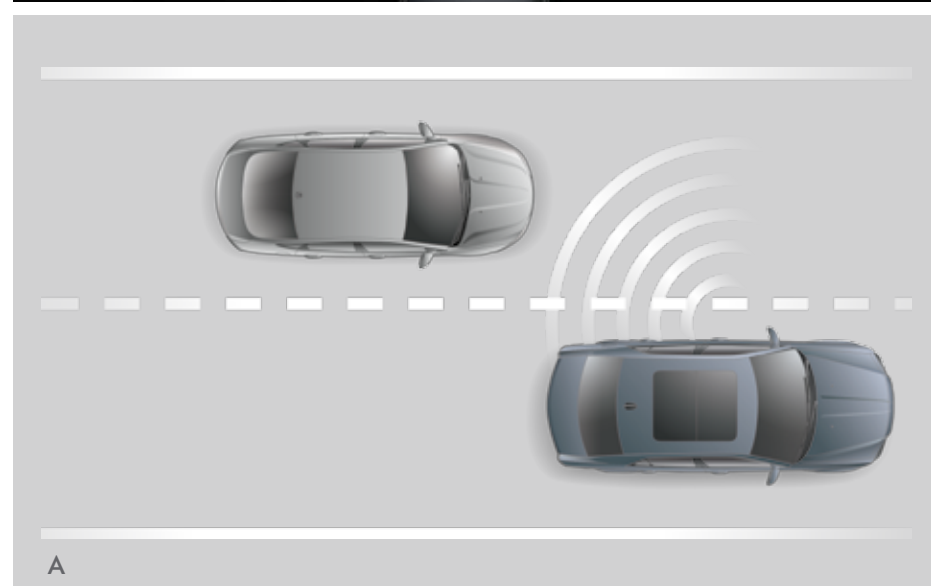

[B] Full-Speed Forward Collision Warning with Active Braking²⁰
 This available system features Active Braking, which slows the vehicle to prevent a potential impact. Using radar and video sensors, the system detects whether the vehicle is approaching another vehicle or large obstacle in its path too rapidly, warning and assisting the driver in avoiding the incident. The driver has the ability to adjust the sensitivity and turn brake support on or off.

[C] Adaptive Cruise Control (ACC) with Stop⁵

This available system identifies vehicles in the forward path by utilizing radar and video sensors to help maintain a safe distance between your vehicle and the one in front of it. ACC with Stop⁵ has the ability to manage cruising speeds between 0 mph and highway cruising speeds with one of four following distances. The system maintains the distance until 0 mph, holding the brakes for two seconds then resuming forward, requiring the driver to take control and manually apply brakes.

[D] LaneSense[®] Lane Departure Warning with Lane Keep Assist²¹

Moves your vehicle back into its intended lane. With a camera mounted inside the rearview mirror and on the front fascia of the vehicle, the available LaneSense system²¹ can identify the lines on the road. It determines where your vehicle is positioned relative to the lines, warning you through the cluster display if you drive onto either line without using a turn indicator. If nothing is done to correct the drift, the system will automatically align the vehicle to its correct lane position.

[E] Available ParkSense.^{®19}

Your luck in securing a great parking spot just took a turn for the better with this automatic, exterior object-detection system. Parking in close range to other vehicles or objects is made easy with four sensors positioned on the front and rear bumpers. The system alerts you with a chime if your vehicle is too close to another vehicle or object, such as a building, bike, parking meter or lot barrier. A visual reference is also located in the Driver Information Display for enhanced parking convenience.

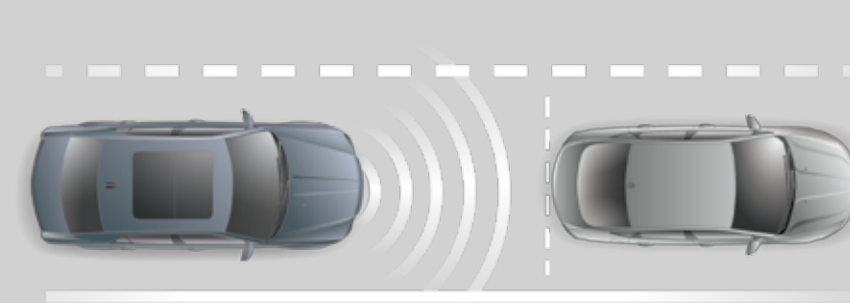

B | C

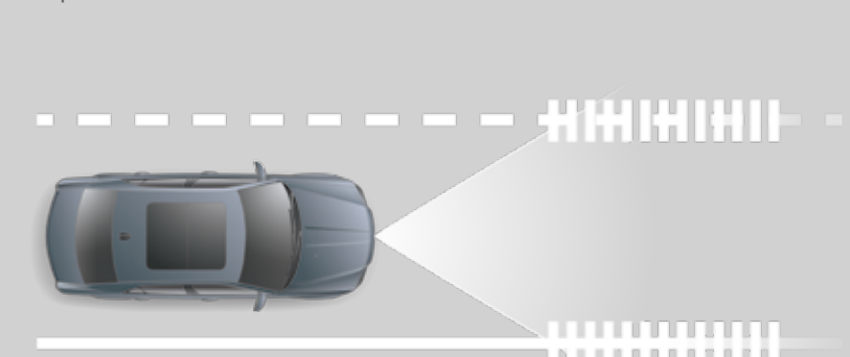

D



E

300 EXTERIOR COLORS



Billet Silver Metallic



Bright White



Maximum Steel Metallic



Velvet Red Pearl Coat



Granite Crystal Metallic



Redline Red Tri-Coat Pearl*



Green Metallic



Ceramic Grey



Gloss Black



Ocean Blue Metallic

*Limited availability.

300 INTERIOR MATERIALS



Black Cloth
Standard on 300 Touring



Linen Cloth
Standard on 300 Touring



Black Nappa Leather Trim
Standard on 300 Touring L

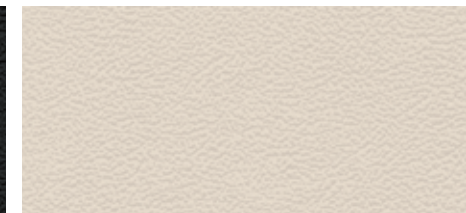

Linen Nappa Leather Trim
Standard on 300 Touring L



Black Nappa Leather Trim with embroidered logo
Standard on 300S

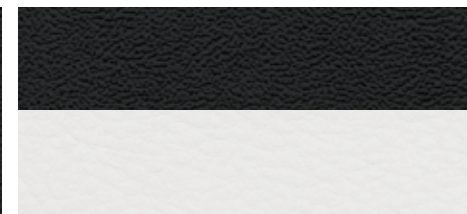

Black/Smoke Nappa Leather Trim with embroidered logo
Standard on 300S



Black Nappa Leather Trim with Caramel accent stitching and embroidered logo
Packaged with Alloy Edition on 300S



Black Nappa Leather Trim with Axis II perforated insert and embroidered logo
Packaged with 300S Premium Group 2



Black/Smoke Nappa Leather Trim with Axis II perforated insert and embroidered logo
Packaged with 300S Premium Group 2



Black Nappa Leather Trim with Alcantara® suede bolsters, Alcantara perforated suede inserts and embroidered logo
Optional on 300S



Black Nappa Leather Trim with Axis II perforated insert
Standard on 300 Limited

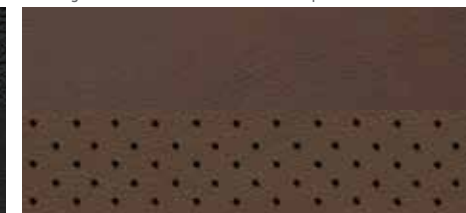

Deep Mocha Nappa Leather Trim with Axis II perforated insert
Standard on 300 Limited

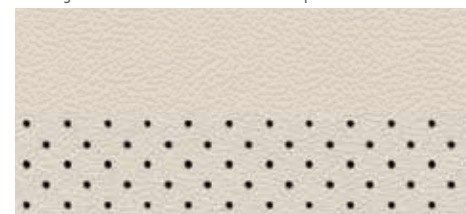

Linen Nappa Leather Trim with Axis II perforated insert
Standard on 300 Limited

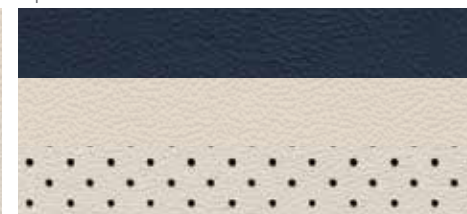

Premium Indigo/Linen Nappa Leather Trim with Axis II perforated insert
Standard on 300C



Premium Black Nappa Leather Trim with Axis II perforated insert
Standard on 300C



Premium Deep Mocha Nappa Leather Trim with Axis II perforated insert
Standard on 300C



300C shown in Maximum Steel Metallic. 300S shown in Redline Red Tri-Coat Pearl with S Model Appearance Package.

300 TOURING: SELECT STANDARD EQUIPMENT

powertrain
3.6L Pentastar® Variable Valve Timing (VVT) V6
8-speed automatic transmission (RWD/AWD)
4-wheel independent suspension

exterior
17-inch Cast-Aluminum Premium Painted Wheel (RWD)
19-inch Cast-Aluminum Wheel Fully Polished (AWD)
Acoustic windshield and front-door glass
Body-color mirror caps and door handles
Automatic projector headlamps
LED daytime running lamps (DRLs)
LED taillamps
Bright Chrome surround with Black grille
Dual exhaust with bright tips
Power heated mirrors

interior
Cloth seats
Power driver seat with 4-way power lumbar adjuster
60/40 split-folding rear bench seat
Tilt/telescoping steering column
Leather-wrapped steering wheel
Uconnect® 4C with 8.4-inch display
6 speakers
Integrated Voice Command⁵ with Bluetooth®
Bluetooth Streaming Audio
SiriusXM® Guardian⁶ with one-year trial
Media Hub (2 USB ports and Aux)
Rotary E-shifter
Keyless Enter 'n Go™/Remote Proximity Entry
Dual-Zone Automatic Temperature Control (ATC)
Speed control
Electric power steering
ParkView® Rear Back-Up Camera¹⁹

WHEELS



17-inch Cast-Aluminum Premium Painted Wheel
Standard on 300 Touring (WBG)



18-inch Cast-Aluminum Wheel Fully Polished
Standard on 300 Touring AWD, Optional on 300 Touring (WPC)

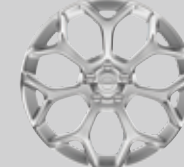

19-inch Cast-Aluminum Wheel Fully Polished
Standard on 300 Touring AWD, Touring L AWD and Limited AWD (WPY)



19-inch Cast-Aluminum Wheel Fully Painted Hyper Black
Standard on 300S AWD (WSF)



19-inch Cast-Aluminum Wheel Fully Painted Dark Bronze
Optional on 300S AWD (WAD)



20-inch Cast-Aluminum Wheel Fully Painted Hyper Black
Standard on 300S, Optional on 300 Touring (WRS)



20-inch Cast-Aluminum Wheel Fully Painted Dark Bronze
Optional on 300S RWD (WAC)



20-inch Cast-Aluminum Wheel Fully Polished
Standard on 300 Limited, Optional on 300 Touring and Touring L (WFY)

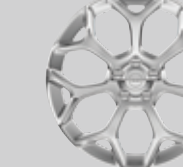

20-inch Cast-Aluminum Wheel Fully Polished with Satin Clear
Standard on 300C (WDE)

300 TOURING L

300 Touring L: Select standard equipment over 300 Touring

powertrain
3.6L Pentastar® Variable Valve Timing (VVT) V6
8-speed automatic transmission (RWD/AWD)

exterior
18-inch Cast-Aluminum Wheel Fully Polished (RWD)
19-inch Cast-Aluminum Wheel Fully Polished (AWD)

interior
Leather-trimmed bucket seats
Power passenger seat with 4-way power lumbar adjuster
Heated front seats
Cargo net
Security alarm
Rear illuminated armrest with storage

300S

300S: Select standard equipment over 300 Touring L

powertrain
Standard 300 hp 3.6L Pentastar VVT V6
8-speed automatic transmission (RWD/AWD)
Optional 5.7L HEMI® V8 8-speed automatic transmission (RWD)

Performance-tuned suspension
Sport mode

exterior
20-inch Cast-Aluminum Wheel Fully Painted Hyper Black (RWD)
19-inch Cast-Aluminum Wheel Fully Painted Hyper Black (AWD)
Headlamps with Black bezels
LED fog lamps
Black LED taillamps
Black Chrome surround with Gloss Black grille
Gloss Black Daylight Opening surround molding
Chrysler wing badge with Black accents
S Model Appearance Package with 5.7L V8

interior
Performance leather-trimmed seats
Steering-wheel paddle shifters
Remote Start System⁴
Universal Garage Door Opener²²
6 premium speakers with 276-watt amplifier

300 LIMITED

300 Limited: Select standard equipment over 300S

powertrain
3.6L Pentastar VVT V6 8.5-speed automatic transmission (RWD/AWD)

exterior
20-inch Cast-Aluminum Wheel Fully Polished (RWD)
19-inch Cast-Aluminum Wheel Fully Polished (AWD)
Chrome mirrors and door handles
Chrome headlamp bezels
Chrome LED taillamps
Bright Chrome surround with Granite Crystal grille
Auto-dimming driver mirror
Auto-adjust-in-Reverse mirrors

interior
Premium leather-trimmed bucket seats
Heated and ventilated front seats
Heated second-row seats
Real wood interior accents
Real wood/leather heated steering wheel
Power tilt/telescoping steering column
Radio/driver-seat/mirrors memory

300C

300C: Select standard equipment over 300 Limited

powertrain
Standard 5.7L HEMI V8 8-speed automatic transmission (RWD)
Sport mode

exterior
20-inch Cast-Aluminum Wheel Fully Polished with Satin Clear (RWD)
Platinum mirrors and door handles
Platinum Chrome surround with luxury Black grille
Automatic headlamp leveling system
Adaptive Bi-xenon High Intensity Discharge (HID) headlamps
300C badge

interior
Luxury perforated Nappa leather-trimmed seats
Luxury leather-wrapped steering wheel
Real open-pore wood interior accents
Steering wheel-mounted paddle shifters
Heated/cooled front console cup holder
Luxury Berber floor mats



Authentic Chrysler Accessories

The Chrysler 300 embodies classic, sophisticated design. A wide range of Authentic Mopar® Accessories, crafted specifically for the versatility of the modern 300, let you take your lifestyle further. From performance and styling enhancements to technological conveniences and Premium Protection Parts, Mopar keeps you looking good to go. Visit your local Chrysler dealership to see the full line of Authentic Accessories for all of the Chrysler 300 models. Vehicle is shown with Matte Black Pinstripe Graphic and 20-Inch Polished Wheels.

mopar.com

300 STANDARD & OPTIONAL FEATURES

	300 TOURING	300 TOURING L	300S	300 LIMITED	300C
Engines and Transmissions					
3.6L Pentastar® V6 Variable Valve Timing (VVT) with 8-speed Automatic Transmission	*	*	*	*	*
5.7L HEMI® V8 VVT with Multi-Displacement System (MDS) Fuel Saver Technology and interactive Deceleration Fuel Shut-Off (DFSO) with 8-speed Automatic Transmission			o		*
MECHANICAL FEATURES					
All-Wheel Drive (AWD) with Front-Axle Disconnect (includes 3.6L V6)	o	o	o	o	
Alternators — 160-amp	*	*			
— 180-amp			*	*	*
Battery — 730-amp, maintenance-free	*	*	*	*	*
Brakes — 4-wheel antilock disc with vented front and solid rear discs (includes All-Speed Traction Control)	*	*	*	*	*
— Performance (packaged with 5.7L HEMI engine and AWD)	P	P	P	P	*
Engine Block Heater	o	o	o	o	o
Exhaust System — Dual exhaust with bright tips	*	*	*	*	*
— Titanium tips (included with Alloy Edition)			P		
Fuel Filler System — Capless, with remote fuel-door release	*	*	*	*	*
Fuel Tank — 18.5-gallon	*	*	*	*	*
Remote Keyless Enter 'n Go™ — Proximity entry and push-button ignition system	*	*	*	*	*
Speed Control	*	*	*	*	*
— Adaptive Cruise Control with Stop ⁵ (included with SafetyTec™ Plus Group)			P	P	P
Sport Mode — Selectable Sport-tuned transmission shift points (includes steering wheel-mounted shift controls; included with 5.7L HEMI V8 engine)			*		*
Steering — Electric	*	*	*	*	*
Suspension — 4-wheel independent AWD	o	o	o	o	
— 4-wheel independent comfort	o	o			
— 4-wheel independent touring	*	*		*	*
— 4-wheel independent performance			*		
Tip Start System	*	*	*	*	*
EXTERIOR FEATURES					
Badging — 300 Limited — Chrome finish	*	*		*	*
— 300S — Black finish			*		
— 300C					*
— AWD	P	P	P	P	
— Rear, Chrysler wing badge	*	*		*	*

EXTERIOR FEATURES (CONTINUED)

	300 TOURING	300 TOURING L	300S	300 LIMITED	300C
— Wing badge with Black accent (packaged with Sport Appearance Package)	P		*		
— Chrysler badge (packaged with Chrome Appearance Package)	P	*	*	*	*
Cladding — Lower bodyside	*	*	*	*	*
Door Handles — Body-color	*	*	*		
— Bright				*	
— Platinum					*
Glass — Acoustic windshield and front doors; Solar-Control front and rear windows	*	*	*	*	*
Grille — Black with Black Chrome surround (packaged with Sport Appearance Package)	P		*		
— Black with bright surround	*	*			
— Black with Platinum surround (packaged with Chrome Appearance Package)	P				*
— Granite Crystal with Chrome surround				*	
— Dark Bronze grille and surround (packaged with Alloy Edition)			P		
Headlamps — Adaptive Bi-xenon High Intensity Discharge (HID) with delay and automatic leveling system (included with 300S Premium Group 2 and Light Group)			P	P	*
— LED daytime running lamps	*	*	*	*	*
— Auto High-Beam Headlamp Control (included with SafetyTec Plus)			P	P	P
— Automatic	*	*	*	*	*
— Bifunctional halogen projector with delay (not available with Adaptive Bi-xenon HID)	*	*	*	*	
— Black bezels (packaged with Sport Appearance Package)	P		*		
— Chrome bezels	*	*		*	*
— LED fog lamps (included with Value Package, Driver Convenience Group and 300 Premium Group)	P	P	*	*	*
— Premium SRT® fog lamps (included with S Model Appearance Package)			P		
Mirrors — Auto tilt-down adjust when in Reverse (included with 300S Premium Group and 300S Premium Group 2)			P	*	*
— Blind Spot Monitoring (BSM) ¹⁸ and Rear Cross-Path Detection ¹⁹ (included with 300S Premium Group 2, 300 Premium Group, 300S Premium Group and SafetyTec Plus)		P	P	P	P
— Body-color	*	*	*		
— Chrome				*	
— Courtesy lamp (driver/passenger; included with 300S Premium Group 2 and 300 Premium Group)		P	P	P	P
— E-Chromic auto-dimming (driver's side only; included with 300 Premium Group and 300S Premium Group 2)		P	P	*	*

* = Included. P = Available within Package noted. O = Optional.



300 STANDARD & OPTIONAL FEATURES (CONT.)	300 TOURING	300 TOURINGL	300S	300 LIMITED	300C
PACKAGES/EQUIPMENT GROUPS (CONTINUED)					
300S Premium Group 2 — Includes power multifunction folding mirrors with auto-adjust-in-Reverse driver's mirrors, auto-dimming exterior driver's mirror, supplemental signals and courtesy lamps, ventilated leather-trimmed seats, Adaptive Bi-xenon High Intensity Discharge (HID) headlamps with automatic leveling system, door sill scuff pads, trunk mat, driver's and front-passenger footwell LED lamps, front and rear LED-illuminated map pockets, heated rear seats, heated steering wheel, power backlight sunshade, power tilt/telescoping steering column, memory for radio, driver's seat and mirrors, ParkSense® Front and Rear Park Assist, ¹⁷ Blind Spot Monitoring (BSM) ¹⁸ and Rear Cross-Path Detection ¹⁹ requires Black, or Black/Smoke interior colors on Black/Caramel interior if Alloy Edition			○		
Alloy Edition — Includes Titanium exhaust tips, Alloy Edition floor mats, Liquid Titanium Chrome wing badge, Dark Bronze badging, Dark Bronze grille and grille surround, 20-inch Dark Bronze aluminum wheels (Rear-Wheel Drive (RWD)) or 19-inch Dark Bronze aluminum wheels (All-Wheel Drive)			○		
Chrome Appearance Package — Includes Chrome-capped power heated mirrors, Chrysler badging, Chrome daylight opening molding and Platinum grille with Platinum surround and 20-inch polished aluminum wheels (restrictions apply)	○				
Driver Convenience Group — Includes Uconnect® 4C NAV with 8.4-inch display and Navigation, front LED fog lamps, Remote Start ⁴ and Universal Garage Door Opener ²² (not available with 300 Premium Group)		○			
Driver Convenience Group — Includes 18-inch polished aluminum wheels on RWD, front LED fog lamps, Remote Start ⁴ and Universal Garage Door Opener ²²	○				
Harman Kardon® Audio Group — Includes 19 high-performance speakers, including subwoofer and 900-watt amplifier (rear sunshade is not available with this group)				○	○
Light Group — Adaptive Bi-xenon HID headlamps with auto-leveling				○	
S Model Appearance Package — Premium SRT® fog lamps, SRT body-color front fascia and appliqué, lower grille close-out panels and rear body-color spoiler and Black Chrome grille surround when ordered without Alloy Edition (included with 5.7L HEMI® V8 engine)			○/P		
Value Package — Includes dual-pane panoramic sunroof, LED fog lamps, Uconnect 4C NAV with 8.4-inch display and Navigation, Remote Start ⁴ and Universal Garage Door Opener ²² (not available with Driver Convenience Group and 300 Premium Group)		○			
Sport Appearance Package — Includes bright Chrome wing badge with Black insert, Black LED taillamps, Black headlamp bezels, Gloss Black daylight opening molding, Black Chrome surround, 300S grille and 20-inch Hyper Black aluminum wheels (not available with Chrome Appearance Package or 300 Premium Group)	○				
Sun, Sound and NAV Package — Includes dual-pane panoramic sunroof, 19 Harman Kardon speakers, Harman Kardon amplifier, Uconnect 4C NAV with 8.4-inch touchscreen display and Navigation					○

• = Included. P = Available within Package noted. ○ = Optional.

300 DIMENSIONS (INCHES)



WARRANTIES²⁴

Chrysler Brand vehicles are covered by an FCA US LLC 3-Year or 36,000-Mile Basic Limited Warranty²⁴ (excludes normal maintenance and wear items), as well as a 5-Year or 60,000-Mile Powertrain Limited Warranty²⁴ that is fully transferable and includes Roadside Assistance services: Flat Tire, Lockout, Towing, Out of Gas/Fuel Delivery and Battery Jump Assistance. Ask your dealer for details and a copy of these limited warranties.²⁴

AUTOMOBILITY PROGRAM

The FCA US LLC Automobility Program provides aftermarket reimbursement incentives on adaptive vehicle upfit equipment in order to help provide safe and reliable vehicle modifications to enhance accessibility for all people. For more information, call (800) 255-9877 or visit chryslerautomobility.com

SIRIUSXM® SATELLITE RADIO⁶

SiriusXM Satellite Radio⁶ delivers over 160 channels, including commercial-free music, sports, news, talk, entertainment, traffic and weather. Factory-installed SiriusXM Satellite Radio⁶ includes a one-year subscription. For more information, go to siriusxm.com

OFFICIAL CHRYSLER OWNER SITE & APP

Your Chrysler Brand vehicle ownership gives you exclusive access to personalized vehicle information, service and maintenance records, recall notifications, roadside assistance, special offers, and more through whatever device you prefer — desktop, tablet, or smartphone! Register for your Chrysler Vehicle Owner Site account at mopar.com/chrysler or download the **Chrysler For Owners app** for free at either the App or Google Play stores.



Earn 3 points per \$1 on qualifying purchases made at FCA US LLC dealerships, 2 points per \$1 on qualifying travel purchases and 1 point per \$1 on qualifying purchases everywhere else with the new Chrysler MasterCard.²⁵ Points may be redeemed at your local dealership for cash off your new or used vehicle, accessories, parts or service — including your next oil change. Or choose from hundreds of other rewards, including travel, cash back to your account, merchandise or gift cards.²⁵ For more information or to apply, visit ChryslerCard.com

MOPAR® VEHICLE PROTECTION

Mopar Vehicle Protection[®] has a vested interest in your satisfaction and owner experience with your new Chrysler Brand vehicle. This is the only extended protection provider backed by the manufacturer, FCA US LLC. We stand behind every Mopar Vehicle Protection plan with certified, factory-trained technicians and the use of authentic Mopar parts. Your plan is honored at over 2,600 dealerships within the United States, Canada, Puerto Rico and Mexico. Be sure to ask for a Mopar Vehicle Protection plan at your dealership, call (800) 442-2666 or visit moparvehicleprotection.com

JOIN IN

Join fellow enthusiasts and tell your story by posting comments, participating in discussions, and sharing your Chrysler Brand vehicle photos and videos. Join our community on Facebook (facebook.com/Chrysler), follow us on Twitter (twitter.com/Chrysler), Google+ (plus.google.com/+Chrysler), Instagram (instagram.com/Chrysler), Pinterest (pinterest.com/Chrysler) and check us out on YouTube (youtube.com/TheChryslerChannel). Thank you for following.

GO MOBILE

Take an engaging, multimedia tour of your Chrysler 300 on your mobile device. Log on to the Chrysler.com mobile site for a comprehensive, at-a-glance review of what you need to know about your vehicle. Experience interactive demonstrations of the entire lineup, gaining access to product information at your fingertips, wherever you go.



CHRYSLER MERCHANDISE

Bring Chrysler Brand distinction to your lifestyle both in and outside your vehicle with apparel, personal accessories, gift cards and more. Shop the complete line at collection.chrysler.com



(1) Based on the latest available competitive information and the FCA US LLC Upper Large Car segmentation. (2) No system, no matter how sophisticated, can repeal the laws of physics or overcome careless driving actions. Performance is limited by available traction, which snow, ice and other conditions can affect. When the ESC warning lamp flashes, the driver needs to use less throttle and adapt speed and driving behavior to prevailing road conditions. Always drive carefully, consistent with conditions. Always wear your seat belt. (3) Requires a mobile phone equipped with the Bluetooth Hands-Free Profile. Visit UconnectPhone.com for system and device compatibility. (4) Remote Vehicle Start not available on all vehicles. You are responsible for using remote features in accordance with any laws, rules or ordinances in effect wherever you operate your vehicle. (5) This system is a driver convenience system, not a substitute for active driver involvement. The driver must remain aware of traffic conditions and be prepared to use the brakes to avoid collisions. (6) SiriusXM audio and data services each require a subscription, sold separately or as a package, by SiriusXM Radio Inc. Your SiriusXM service will automatically stop at the end of your trial unless you decide to subscribe. If you decide to continue service after your trial, the subscription plan you choose will automatically renew thereafter and you will be charged according to your chosen payment method at then-current rates. Fees and taxes apply. To cancel, you must call SiriusXM at 1-866-635-2349. See SiriusXM Customer Agreement for complete terms at www.siriusxm.com. All fees and programming subject to change. Not all vehicles or devices are capable of receiving all services offered by SiriusXM. Current information and features may not be available in all locations or on all receivers. (7) All SiriusXM Guardian-equipped vehicles come with a 12-month complimentary trial effective on the date of purchase or lease of a new vehicle. Enrollment in the trial is required to receive service. Upon expiration of the trial period, purchase of a subscription is required to continue SiriusXM Guardian. SiriusXM Guardian is available only on equipped vehicles purchased within the United States, Puerto Rico and Canada. Services can only be used where cellular coverage is available. See Uconnect and SiriusXM Guardian Terms of Service for complete service limitations. (8) In the event of a medical or other emergency, press the SOS button to be connected to a Customer Care agent who can direct emergency assistance to your vehicle's location. (9) Roadside Assistance Call provides direct calling to an agent who can provide the vehicle location to Roadside Assistance Service. Vehicle must be within the United States, Puerto Rico or Canada and have network coverage. Additional roadside assistance charges may apply. Check warranty for details. (10) To use Vehicle Finder, you must have the SiriusXM Guardian mobile app installed on a compatible smartphone and have an active subscription to SiriusXM Guardian. (11) Active SiriusXM Guardian subscription is required to use this service. Stolen vehicle police report required. Always notify law enforcement if your vehicle is stolen and do not attempt to recover it on your own. (12) Wi-Fi subscription required. Vehicle must be properly equipped and in active and usable cellular range for Wi-Fi usage. Wi-Fi Hotspot does not enable direct communication between multiple in-vehicle devices. Factors affecting the performance of Wi-Fi Hotspot include: cellular network, signal strength and quality, time of day, number of channels used by the service provider, type of connection, number of clients using Wi-Fi Hotspot and client device. This feature is not intended for use by the driver while the vehicle is in motion. Always drive safely. (13) Android Auto uses your smartphone's data plan. Additional charges may apply. To use Android Auto, you must be in an area with cellular coverage. Requires the Android Auto app on Google Play and an Android-compatible smartphone running Android 5.0 Lollipop or higher. (14) Voice Text Reply and Voice Texting features require a compatible mobile device enabled with Bluetooth Message Access Profile (MAP). iPhone and some other smartphones do not currently support Bluetooth MAP. Visit www.UconnectPhone.com for system and device compatibility. Ensure MAP is ON and incoming message notification is enabled. Vehicle must be registered for Uconnect Access and you must fulfill minimum subscription requirements. Also requires the use of a compatible smartphone that supports text messaging and Bluetooth. Check UconnectPhone.com for device compatibility. (15) Apple CarPlay uses your smartphone's data plan. Additional charges may apply. To use Apple CarPlay, you must be in an area with cellular coverage. (16) Siri Eyes Free requires an iPhone equipped with Siri. Certain features not available while the vehicle is in motion. iPhone must be within active cellular range. Customer's existing iPhone data rates apply to Internet-supported features. (17) The Advanced Front Air Bags in this vehicle are certified to the new U.S. Federal regulations for Advanced Air Bags. Children 12 years old and younger should always ride buckled up in a rear seat. Infants in rear-facing child restraints should never ride in the front seat of a vehicle with a passenger front air bag. All occupants should always wear their lap and shoulder belts properly. (18) Always check visually for vehicles prior to changing lanes. (19) Always look before proceeding. An electronic drive aid is not a substitute for conscientious driving. Always be aware of your surroundings. (20) This system is not intended to avoid collisions on its own, nor can FCW detect every type of potential crash. The driver must remain aware of traffic conditions and be prepared to brake and steer to avoid potential collisions at all times. (21) This system is a driver convenience system, not a substitute for active driver involvement. The driver must remain aware of traffic conditions and maintain control of the vehicle. (22) Not compatible with all garage door openers. (23) Always sit properly with the head restraint properly adjusted. Never place anything in front of the head restraint. (24) Transferable. See dealer for details and a copy of the limited warranty. Includes towing to an authorized dealer. (25) Complete details, including restrictions, limitations and exclusions, will be available when you become a Cardmember. MasterCard is a registered trademark of MasterCard International Incorporated. This card is issued by First Bankcard, a division of First National Bank of Omaha, pursuant to a license by MasterCard International Incorporated.

©2017 FCA US LLC. All Rights Reserved. Chrysler, Dodge, Jeep, Ram, Mopar, SRT, the Chrysler wing design, Chrysler 300, Automobility Program, HEMI, Imported From Detroit, LaneSense, Mopar Vehicle Protection, ParkSense, ParkView, Pentastar, Sentry Key, TorqueFlite and Uconnect are registered trademarks, and Keyless Enter 'n Go and SafetyTec are trademarks of FCA US LLC.

Alcantara is a registered trademark of Alcantara S.p.A. Apple CarPlay is a trademark, and iOS, iPhone, iTunes and Siri are registered trademarks of Apple Inc. AT&T is a registered trademark of AT&T Knowledge Ventures. Dr. Dre, Beats, BeatsAudio and the b logo are trademarks of Beats Electronics, LLC. Bluetooth is a registered trademark of Bluetooth SIG, Inc. Facebook and logo are registered trademarks of Facebook, Inc. Google, Android, Android Auto, Google Play, YouTube and other marks are trademarks of Google Inc. Harman Kardon and Logic 7 are registered trademarks and GreenEdge is a trademark of Harman International Industries, Inc. Instagram is a registered trademark of Instagram, Inc. Pinterest is a registered trademark of Pinterest, Inc. SiriusXM Connected Vehicles Services Inc., Sirius, XM, SiriusXM and SiriusXM Guardian and all related marks and logos are registered trademarks of SiriusXM Radio Inc. The Twitter name, logo, Twitter T, Tweet and Twitter bird are service marks of Twitter, Inc. in the United States and other countries.

This brochure is a publication of FCA US LLC. All product illustrations and specifications are based upon current information at the time of publication approval. FCA US LLC reserves the right to make changes from time to time, without notice or obligation, in prices, specifications, colors and materials, and to change or discontinue models, which are considered necessary to the purpose of product improvement or for reasons of design and/or marketing.



74-383-3811 (9/17-37M)

