

2010 Jeep®  
Wrangler



[machaikdcj.com](http://machaikdcj.com)



# Dynamic duo.

There's absolutely nothing else out there like the 2010 Jeep® Wrangler. Built tough and backed by more than 65 years of American legend, Jeep Wrangler puts its less capable rivals to shame. All of Wrangler's components, like heavy-duty suspension, skid plates, and shock absorbers, have been tirelessly torture-tested countless times in some of the most brutal environments known to mankind — so you can rest assured your Jeep vehicle will live up to its tough-to-the-core reputation. Other available features, like the Media Center radio with GPS navigation, let you make the most of trails or rush-hour traffic. Every Wrangler two-door model features comfortable seating for four passengers while Wrangler Unlimited models show off four doors and spacious seating for five. Head out with purpose and build from there.

[machaikdcj.com](http://machaikdcj.com)

# How a trademark becomes a benchmark.

Both Jeep® Wrangler and Wrangler Unlimited have been fortified with components that deliver the highest degree of proven capability so you have the freedom to get out there and do your thing. The Dana 44 solid rear axle is durable, thanks to a large pinion and unitized wheel bearings. The Command-Trac® part-time 4WD system features a 2-speed transfer case with shift-on-the-fly capability. A four-wheel disc antilock brake system (ABS) with a Jeep 4WD off-road calibration system provides sustained wheel lockup on surfaces like mud, sand, and gravel. The 3.8L SMPI V6 engine may be quiet and light, but that doesn't stop it from harnessing a powerful 202 hp and 237 lb-ft of torque. Drivers seeking more control when tackling the great outdoors or changing highway lanes will appreciate the standard 6-speed manual transmission. Those who enjoy the freedom of hands-free shifting can opt for the convenience of a 4-speed automatic transmission.<sup>(1)</sup> For those who have toys to take along, Wrangler Unlimited can confidently tow up to 3,500 lb when properly equipped with the factory-installed Trailer Tow Group.

<sup>(1)</sup>4-speed automatic transmission is standard on Wrangler Unlimited 2WD models, available on all other Wrangler and Wrangler Unlimited models.



[machaikdcj.com](http://machaikdcj.com)

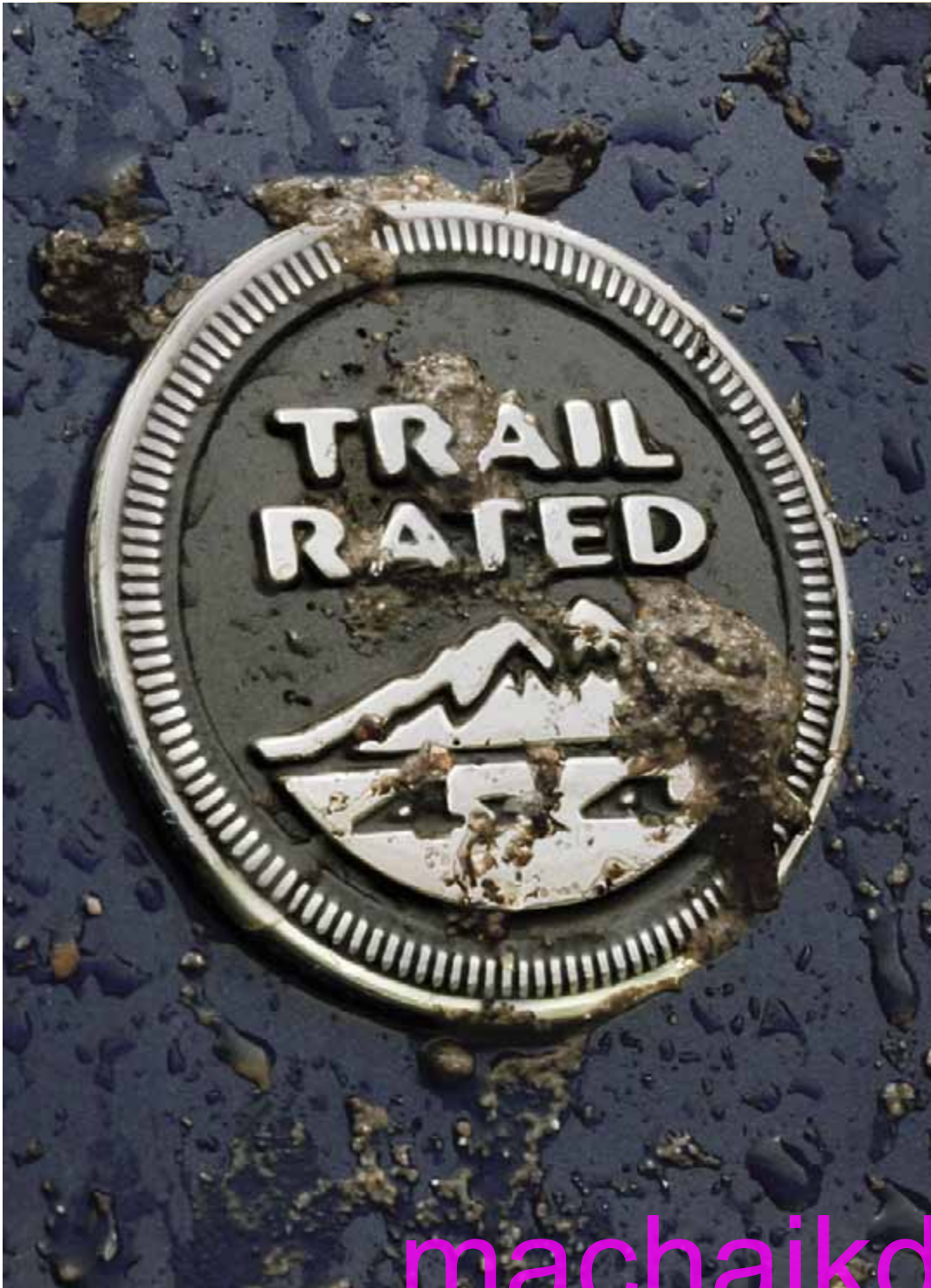

**JEEP TRAIL RATED®** vehicles are designed to perform in a variety of off-road conditions. Five performance categories outline the superior capabilities that all Trail Rated vehicles share.



#### **ARTICULATION**

A Trail Rated suspension system is limber, like a gymnast. How exactly? Flexibility is the key to good articulation. The more a wheel can travel and suspension flex, the better it can maintain contact with terra firma and provide the traction needed to cross an array of obstacles.



#### **TRACTION**

The vehicle maintains forward momentum through the tires staying in contact with the road or trail. Trail Rated traction helps you stay in control on untamed terrain, slippery (wet, mud, snow) conditions, and on steep grades.



#### **MANEUVERABILITY**

Athletic. Agile. Trail Rated. Jeep 4WD vehicles have the footwork to help navigate narrow gaps, dodge emergency situations, and avoid cosmetic damage to the underbody, thanks to precision steering and optimized wheelbases.



#### **GROUND CLEARANCE**

Help keep your belly out of the mud. Clear nasty logs, rocks, and uneven ground while helping to prevent undercarriage damage. Trail Rated vehicles feature optimized approach, departure, and breakover angles to keep you in the clear.



#### **WATER FORDING<sup>(1)</sup>**

Hit that riverbed with confidence. A Trail Rated Jeep vehicle features additional electrical and body sealing, along with a high air intake location for optimum water fording capability.

<sup>(1)</sup>Do not attempt water fording unless depth is known to be less than 20 inches. Traversing water can cause damage that may not be covered by the new vehicle warranty. Always off-road responsibly in approved areas.



The freedom to **explore nature.**

[machaikdcj.com](http://machaikdcj.com)

#### Tru-Lok® locking differentials

Front and rear electronic-locking differentials balance speed between left and right wheels, maintaining forward momentum for the ultimate in Wrangler traction. The instrument panel-mounted rocker switch can lock either the rear or both axles (standard on Rubicon).

#### Command-Trac® transfer case

A NV241 Gll transfer case is smooth, quiet, and tough. Ribs and a stiff outer case also reduce the potential for leakage (standard on Sahara and Sport 4WD models).

#### Rock-Trac® transfer case

A 4:1 low-gear ratio allows Wrangler Rubicon to crawl at a low speed for greater control and increases the amount of torque available at the wheels (standard on Rubicon).

#### Front sway bar disconnect system

With the flip of a switch, the sway bar automatically disengages when driving under 18 mph in 4WD-low (4LO) mode. This allows the front wheels to drop and compress up to 22 percent further on Wrangler or 25 percent further on Wrangler Unlimited (standard on Rubicon).

**Rock rails** Extra-tough body-mounted rails provide additional protection (standard on Rubicon).

#### Two-piece structural oil pan

A two-piece oil pan provides a steel lower portion for impact resistance with an upper aluminum section for improved noise reduction and weight savings.

#### Best-in-Class ground clearance<sup>1)</sup>

Rubicon's standard 32-inch BF Goodrich® off-road tires have a custom tread pattern that is exclusive to the Jeep brand giving Wrangler over 10 inches of ground clearance.

#### Next Generation Dana 44 heavy-duty solid axles

Durability and articulation come from heavy shafts, stiff housings, large pinion bearings, and above-center pinion mountings. The above-center joint angles for smoother, quieter operation and also adds ground clearance (Rear Dana 44 standard on all models. Front Dana 44 standard on Rubicon).

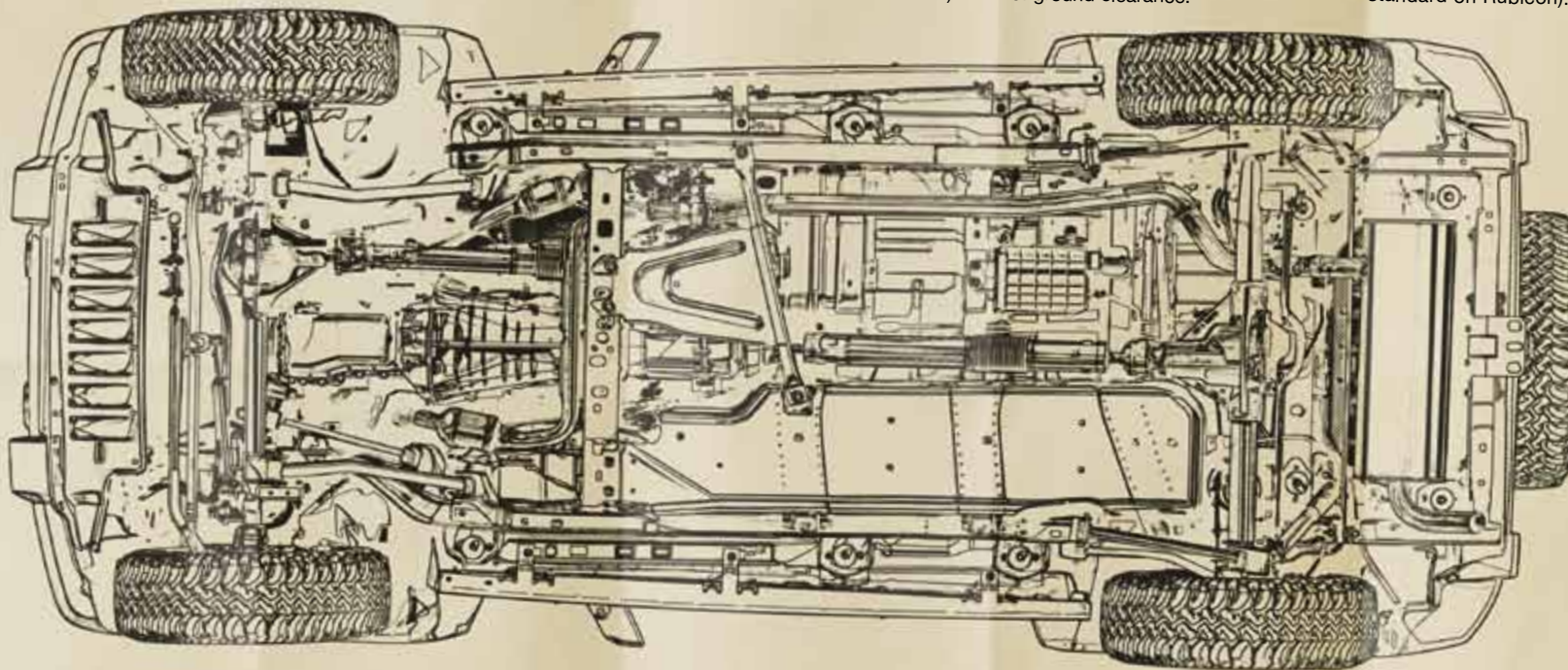

#### Keep steering on course

Wrangler features a steering linkage and a recirculating-ball steering gear. Its robust, cross-link geometry offers the stiffest possible linkage system in a solid-axle platform for steering precision and Best-in-Class turning diameter.<sup>1)</sup>

**Body-on-frame design** Built with a frame that's fully boxed for strength, stiffness, and durability.

**Skid plates** Stamped steel skid plates for fuel tank, transfer case,<sup>2)</sup> and automatic transmission oil pan<sup>2)</sup> help protect Wrangler's guts when battling boulders and jagged rocks (standard on all models).

**Heavy-duty suspension** Solid axles with locating arms, coil springs, track/stabilizer bars, front steering damper, and high-pressure gas-charged monotube shock absorbers are comfortably capable (standard on Sahara and Rubicon).

**Drive by wire** The Electronic Throttle Control (ETC) system helps prevent the "pedal bobble" that often occurs when in 4WD-low (4LO) mode (when equipped). ETC's special off-road calibrations help the driver to "feather in" the throttle over uneven terrain, logs, and rocks. The difference is night and day and is akin to walking versus bouncing along tough off-road events.

#### Tunable monotube shock absorbers

A proprietary Low-Speed Tunable (LST) valve technology is firm at low speeds for improved feel on rocks and offers a more relaxed feel at higher speeds for optimum highway driving (standard on Sahara and Rubicon).

**Torque to tow** Unlimited can confidently tow up to 3,500 lb when properly equipped with the factory-installed Trailer Tow Group.

#### Off- and on-road brake systems

A four-wheel disc antilock brake system (ABS) with a Jeep 4WD off-road calibration system provides more sustained wheel lockup on surfaces — like mud, sand, and gravel — than normal ABS for improved stopping performance (standard on 4WD models).

<sup>1)</sup>Based on *Ward's* 2009 Small Sport/Utility segment.

<sup>2)</sup>When properly equipped.

# Impressive **views.**



#### **Extreme open-air driving**

Wrangler and Wrangler Unlimited take open-air driving to the extreme with standard removable full-framed doors and fold-down<sup>(1)</sup> windshield that is curved for optimum aerodynamics and reduced wind noise.

#### **Sound bar with integrated speakers**

Turn it up and rock it out with a pair of 6.5-inch overhead speakers that are, of course, fully weather-resistant.

#### **Power Convenience Group**

Power windows, power door locks, remote keyless entry, and a security alarm are available with the removable full-framed doors in the Power Convenience Group.

#### **Soft top, hardtop, or dual top**

The unique, open-air design intensifies the off-road, outdoor experience. No other 4x4 comes close to offering as many configurations as Wrangler provides standard.

#### **Take more gear**

Behind the rear seats you'll find plenty of cargo room for adventure gear. There's 17.2 cu ft on two-door models and 46.4 cu ft on four-door models.

<sup>(1)</sup>Be sure to follow all instructions in Owner's Manual for removal of top, doors and lowering of windshield. Driving with doors off and windshield down is for off-road use only. Properly secure all cargo. Unlimited Rubicon shown.



# Proud nudist.

**Removable.** Hardtop. Soft top. Equally fun ways to bare it all.

**Foldable.** Fold-down windshield<sup>(1)</sup> helps off-road visibility.



**Detachable.** For that breeze-in-your-sandals experience while on the trails.

<sup>(1)</sup>Be sure to follow all instructions in Owner's Manual for removal of top, doors and lowering of windshield. Driving with doors off and windshield down is for off-road use only.

## There's no place the sun doesn't shine.

Choose any Jeep® Wrangler, crank up the stereo, pop the top, and experience wind-at-your-back freedom. Full-framed and available half-framed removable doors offer even more open-air freedom. You don't need to go far to leave it all behind.

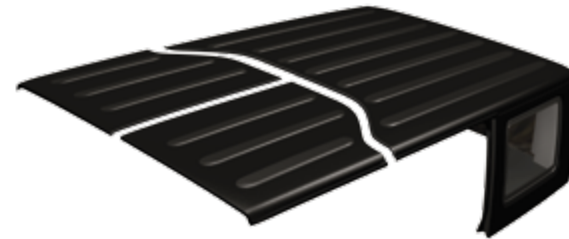
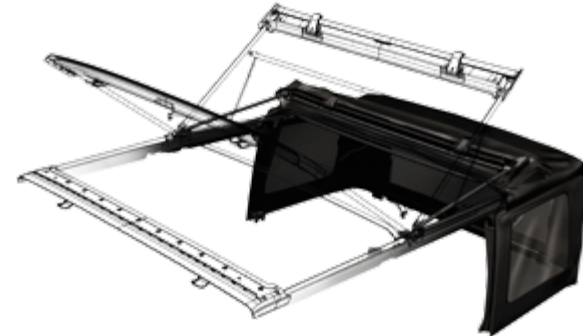

**Sunsational soft tops.** The standard Sunrider® Soft Top now features a convenient cable release that lets you quickly get cover or let the sun shine in without having to fold back the entire top. It also completely folds down and tucks away. Made of a three-ply sailcloth fabric that helps reflect road sounds, absorb wind noise, prevent buffeting, and enhance overall insulation.

**Heavenly hardtop.** The available Freedom Top® three-piece modular hardtop allows you to control how much sun you let in by separating into three manageable and easy to store pieces. Without the two front panels, the back of the hardtop becomes easier for two adults to remove.





[machaikdcj.com](http://machaikdcj.com)

# Far-reaching safety and security.

★ ★ ★ ★ ★  
FIVE-STAR

HIGHEST GOVERNMENT  
FRONT CRASH TEST RATING

Jeep® Wrangler and Wrangler Unlimited received the highest marks — five stars — during driver and front-passenger crash tests held by the U.S. Department of Transportation's SaferCar.gov program.<sup>(1)</sup> Advanced multistage front air bags<sup>(2)</sup> and available seat mounted supplemental side air bags<sup>(2)</sup> provide nearly instantaneous occupant protection. The standard Electronic Stability Control (ESC)<sup>(3)</sup> is designed to assist drivers in maintaining control of their vehicle, especially on low-friction surfaces, including wet, snowy, icy, sandy, or gravel roads. ESC uses the collective technologies of hydraulic brake assist, traction control, Electronic Roll Mitigation (ERM), and Trailer Sway Control (TSC)<sup>(4)</sup> to constantly monitor the driver's input against the vehicle's actual course. If needed, ESC will attempt to correct the vehicle's course by automatically applying the brake and/or reducing engine torque. Hill Start Assist (HSA) prevents Wrangler from unintended rolling backward when starting the vehicle on a downhill gradient, holding the vehicle stationary for two seconds after the brake is released, allowing time to apply the throttle. The mid-mounted fuel tank is protected by its robust 2.5-mm skid plate during off-road activity. Energy-absorbing front rail extensions are crushable, hydroformed front rail tips that can be serviced after low-speed (up to 8 mph) impact events. Standard halogen headlamps and fog lamps improve down-road visibility.

<sup>(1)</sup>Star ratings are part of the U.S. Department of Transportation's SaferCar.gov program (safercar.gov).

<sup>(2)</sup>The Advanced Front Air Bags in this vehicle are certified to the new Federal regulations for advanced air bags. Children 12 years old and younger should always ride buckled up in a rear seat. Infants in rear-facing child restraints should never ride in the front seat of a vehicle with a passenger front air bag. All occupants should always wear their lap and shoulder belts properly. <sup>(3)</sup>No system, no matter how sophisticated, can repeal the laws of physics or overcome careless driving actions. Performance is limited by available traction, which snow, ice and other conditions can affect. When the ESC warning lamp in the speedometer flashes, the driver needs to use less throttle and adapt speed and driving behavior to prevailing road conditions. Always drive carefully, consistent with conditions. Always wear your seat belt.

<sup>(4)</sup>Trailer Sway Control is only available with the Trailer Tow Group.



machaikdcj.com



### Sound possibilities.

New Technology Generation 4 (NTG4) radios with WMA and MP3 audio input jacks and six-speaker audio system are standard. There are two strategically placed .75-inch weather-resistant tombstone tweeters and four 6.5-inch speakers (two in the front instrument panel and two in the overhead sound bar). Available on all models is a premium sound system that includes six ∞Infinity® speakers and 8-inch subwoofer with a 368-watt high-power amplifier. The eight-channel subwoofer provides discrete power and crystal clear sound.



Left: An exclusive overhead sound bar features two 6.5-inch mid-range speakers for the ultimate in highway or off-road driving sound.

[machaikdcj.com](http://machaikdcj.com)

# Sky-high tech.



With Uconnect™, you're always connected — to people, places, music, movies, and the Internet.

**Voice Command.** Lets you select radio stations, satellite radio channels,<sup>(1)</sup> and navigation<sup>(1)</sup> destinations using voice commands. Works with all Uconnect Media Center radios. Included with Uconnect Phone.

**Uconnect Phone.** Lets you talk on your Bluetooth® compatible phone virtually hands-free. Address Sync<sup>(2)</sup> lets you call anyone in your address book by saying their name.

**Audio Jack.** Connect a 3.5-mm audio cable from your MP3 player, phone, or electronic book reader to play audio through your car's speakers.

**Media Center 730N AM/FM/CD/DVD<sup>(3)</sup> Radio with 30GB Hard Drive and GPS Navigation.** 6.5-inch touch screen, MP3/WMA support, USB input, 4,250 song capacity, SIRIUS® Satellite Radio,<sup>(4)</sup> SIRIUS Traffic,<sup>(5)</sup> and Voice Command.

**iPod® Control.** Connect most iPod-compatible devices to your car's stereo using the in-car cable; then control them with your radio or steering wheel controls. Keeps the devices charged too. iPod Control is an Authentic Jeep® Accessory by Mopar.

**Uconnect Web.<sup>(6)</sup>** An in-car router that connects any Wi-Fi-enabled device to the Internet at 3G broadband speeds, allowing multiple passengers to surf the Web and social networks, look up directions, check eMail, or download music. Uconnect Web is an Authentic Jeep Accessory by Mopar. Subscription required, sold separately.

<sup>(1)</sup>When satellite radio and navigation features are equipped on your vehicle. Any voice-commanded system should be used only in safe driving conditions and all attention should be kept on the roadway ahead. Failure to do so may result in an accident causing serious injury or death. <sup>(2)</sup>Phone must support Bluetooth Phone Book Access Profile (PBAP) <sup>(3)</sup>In-dash DVD capability not available in all states. See your dealer for details. <sup>(4)</sup>SIRIUS service available only in contiguous United States and D.C. Service available in Canada; see siriuscanada.ca. Subscription required after 12-month subscription included with vehicle purchase. Subscriptions governed by SIRIUS Terms & Conditions available at sirius.com. SIRIUS, XM, and all related marks and logos are trademarks of SIRIUS XM Radio Inc. and its subsidiaries. <sup>(6)</sup>The Uconnect Web feature is not intended for use by the driver while the vehicle is in motion.

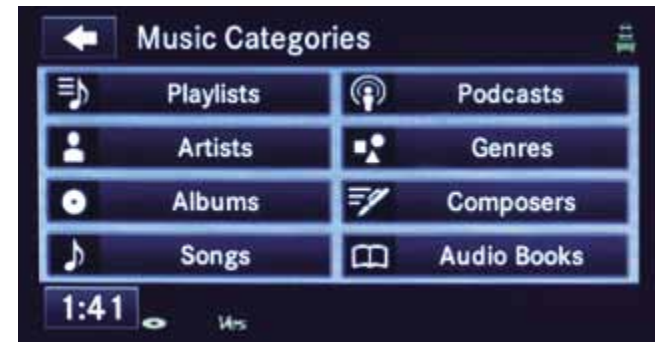

[machaikdcj.com](http://machaikdcj.com)



Jeep® Wrangler Unlimited Rubicon cloth interior shown in Medium Slate Gray.

# My, what **big claws** you have.

## **Rubicon.**

When it comes to massive capability, Jeep Wrangler Rubicon and Unlimited Rubicon have the brawn. Wrangler Rubicon boasts Best-in-Class<sup>(1)</sup> approach and departure angles, Best-in-Class<sup>(1)</sup> ground clearance, solid front and rear axles, electronically locking differentials, huge tires, steel plate underbody armor, and the Rock-Trac<sup>®</sup> transfer case delivers a 4:1 low range for great off-road capability. The heavy-duty rock rails aren't "solely for the appearance of the vehicle." They're bolted directly to the underbody for added strength and durability when sliding over rocks and boulders. When it's best to go wisely and slowly, Rubicon offers an incredible 73.1:1 crawl ratio — allowing for a controlled 0.5 mph cruise up the rocks. Flip a switch and Rubicon disengages its standard front sway bar when driving under 18 mph in 4WD-low (4LO) mode for maximum suspension articulation. Because everyone deserves a Jeep mountaintop experience, Rubicon seats four and Unlimited Rubicon offers seating for five. When control is everything, choose Rubicon or Unlimited Rubicon.



Rubicon's muscular capability grabs you with standard 32-inch Tall BF Goodrich® Mud Terrain Tires and 17-inch cast aluminum wheels. You're good to Go Anywhere, Do Anything™ right out of the box.

<sup>(1)</sup>Based on Ward's 2009 Small Sport/Utility segment.

Jeep® Wrangler Rubicon shown in Dark Charcoal Pearl with Authentic Jeep Accessories by Mopar, including 17x8.5-Inch Beadlock Rock Monster Wheels, Warn® Winch, Windshield-Mounted Off-Road Lights, Skid Plates, Rock Rails and Off-Road Bumpers.



[machaikdcj.com](http://machaikdcj.com)



Jeep Wrangler Unlimited Sahara shown in Red Rock Crystal Pearl with two-tone Dark/Medium Khaki leather-trimmed interior with Soft Top Boot, an Authentic Jeep Accessory by Mopar.

[machaike.com](http://machaike.com)

# Creatures need **comfort** too.



Driver seat includes a pump handle with a retracting mechanism that can raise the seat up nearly two inches. A four-way position adjuster is standard on the driver's seat.

**Sahara.** Jeep® Wrangler Sahara and Unlimited Sahara are the ideal blend of capability and comfort for those who demand a complete open-air 4x4 experience yet still want to be spoiled on the daily commute. The exterior sports body-color fender flares and black front and rear fascias with Silver accents. Sahara's diamond plate texture side steps help divert air for improved aerodynamics while adding style and convenience. Inside you'll find standard cloth seats or you can upgrade to the stylish and comfortable two-tone leather-trimmed seats; unique Silver accents; air conditioning; ∞Infinity® seven-speaker sound system; and SIRIUS® Satellite Radio. The premium instrument cluster includes compass, temperature, and a trip display that shows important vehicle stats. The Power Convenience Group with power locks, one-touch-down power front windows, remote keyless entry system, and security alarm is also included.



## Wide open spaces.

Secured storage bin beneath Wrangler's rear floor helps keep valuables safe and secure. The floor console multitasks just like you and includes cup holders, a locking storage bin, drop-in bin, and armrest. When you answer the call of the wild, be sure to properly secure all cargo.

[machaikdcj.com](http://machaikdcj.com)

# Adventurous nature.

**Sport.** Jeep® Wrangler Sport and Unlimited Sport are the trailhead of the Jeep Brand experience — the 4WD starting point for fun, adventure, and the Jeep family. Drive Wrangler Sport and you become part of a Jeep 4x4 community that lives to find a new kind of freedom anywhere, anytime. Like the freedom to explore our country's back roads, trails, and hideaways. You have the option to leave the standard Sunrider® Soft Top down in a light rainstorm (also works with the available Freedom Top® three-piece modular hardtop). Or the power to pass on the freeway with a powerful 3.8L V6 engine. Or the confidence to know Wrangler Sport's standard Command-Trac® 4WD will go virtually anywhere you direct it.

Unlimited Sport's five-link coil suspension helps ensure a comfortable ride for everyone, especially rear passengers. Plus, the interior is completely accommodating with the flexibility to plug and play your own MP3 tunes on the standard AM/FM stereo radio/CD player with auxiliary input jack. And whether you choose two doors or four doors, you have the option of driving with the doors off and the windshield down<sup>(1)</sup> when off-roading.

<sup>(1)</sup>Be sure to follow all instructions in Owner's Manual for removal of top, doors and lowering of windshield. Driving with doors off and windshield down is for off-road use only.



Standard Fold and Tumble rear bench seats are found on all Wrangler two-door models. Wrangler four-door models come standard with a split-folding rear seat.



## **Fear no mud, dirt, or spills.**

Have some good, clean fun. Wash-out interior with drain plugs is standard on all Wrangler models.

Far Left: Jeep Wrangler Unlimited Sport cloth interior shown in Medium Slate Gray.

[machaikdcj.com](http://machaikdcj.com)



[machaikdcj.com](http://machaikdcj.com)

Jeep® Wrangler Sport shown in Black.



[machaikdcj.com](http://machaikdcj.com)



### Sport

Unlimited Sport shown.

- 3.8L SMPI V6 Engine
- Command-Trac® 4WD (4WD models)
- 6-Speed Manual Transmission (4WD models)
- Next Generation Dana 44 Heavy-Duty Solid Rear Axle
- Skid Plates
- Advanced Multistage Driver and Front-Passenger Air Bags
- Antilock Brake System (ABS)
- Electronic Stability Control (ESC)
- Hill Start Assist
- All-Speed Traction Control
- Electronic Roll Mitigation (ERM)
- Sentry Key® Antitheft Engine Immobilizer
- Sunrider® Soft Top
- Removable Full-Framed Doors
- Sliding Sun Visors with Mirrors
- Six Speakers
- AM/FM Stereo Radio with CD Player and Auxiliary Input Jack
- Wash-Out Interior
- Fog Lamps
- Tow Hooks
- Secured Underfloor Cargo Area Storage
- Locking Glove Box and Full-Floor Console



### Sahara

Sahara shown.

- Tubular Side Steps
- High-Pressure Monotube Shocks with Low-Speed Tunable Valve Technology
- SIRIUS® Satellite Radio
- Seven ∞Infinity Speakers, including Subwoofer and 368-Watt Amplifier
- Power Locks and Windows with Front One-Touch Down
- Remote Keyless Entry
- Security Alarm
- 18-Inch Cast Aluminum Wheels
- Air Conditioning
- Leather-Wrapped Steering Wheel with Satin Silver Spokes and Speed Control
- Hood Insulation
- Body-Color Fender Flares
- Front and Rear Fascias with Silver Bumper Insert
- Deep-Tint Sunscreen Rear and Quarter Windows
- Removable Full-Framed Doors
- "Sahara" Decal on Front Quarter Panels
- Fog Lamps, Tow Hooks and Skid Plates
- All-Speed Traction Control



### Rubicon

Unlimited Rubicon shown.

- Rock-Trac® 4WD
- Tru-Lok® Front/Rear Electronic Locking Differentials
- Front Sway Bar Disconnect System
- High-Pressure Monotube Shocks with Low-Speed Tunable Valve Technology
- Seven ∞Infinity® Speakers, including Subwoofer and 368-Watt Amplifier
- SIRIUS Satellite Radio with One-Year Free Subscription Included
- 32-Inch-Tall BF Goodrich® Mud Terrain Tires
- 17-inch Cast Aluminum Wheels
- Heavy-Duty Rock Rails
- Leather-Wrapped Steering Wheel with Speed Control
- Performance-Tuned Heavy-Duty Suspension
- Fog Lamps, Tow Hooks, and Skid Plates
- "Rubicon" decals on hood
- Hill Start Assist
- Wash-Out Interior
- Electronic Stability Control (ESC)
- Electronic Roll Mitigation (ERM)
- Next Generation Dana 44 Heavy-Duty Front Axle

# Select Standard Features

See Specification Chart for Additional Standard and Available Options and Packages.



**16-inch** Slot Spoke Styled Steel Painted Argent Standard on Sport, Unlimited Sport, and Unlimited Right-Hand Drive



**17-inch** Moab Cast Aluminum Painted Sparkle Silver — Available on Sport and Unlimited Sport



**18-inch** Gladiator Cast Aluminum Painted Satin Silver — Standard on Sahara and Unlimited Sahara



**17-inch** Moab Cast Aluminum Painted Satin Carbon — Standard on Rubicon and Unlimited Rubicon

machaikej.com



### Freedom Top® Hardtop

Strong and secure hardtop offers solid protection from the elements and helps quiet your ride. Enjoy the best of both hardtop and soft top worlds when you choose the Dual-Top Group.

— Available on Wrangler and Wrangler Unlimited in Black or Dark Khaki<sup>(1)</sup>



### Sunrider® Soft Top

Utilizes a special three-ply material that is quiet, watertight, and easy to fold and tuck away. Standard on all Wrangler models is the exclusive Sunrider® Soft Top.

— Standard on Wrangler and Wrangler Unlimited sailcloth soft top in Black or Dark Khaki<sup>(1)</sup>

<sup>(1)</sup>Dark Khaki top color is only available on Sahara models.



### Full-Framed Doors

Full-framed doors are removable and have roll-up windows with available power windows and door locks. Map pockets with open slots along the lower edges ensure wash-out capability. Aluminum-forged hinges are used on both Wrangler and Wrangler Unlimited. Standard on all models.



### Half-Framed Doors

Half-framed doors are removable and feature manual locks. You can remove the doors completely for the ultimate in open-air freedom. Available on Sport and Rubicon models.



### Everest Cloth/Wallace II Cloth

— Standard on all models



Medium Khaki



Medium Slate Gray

### McKinley Two-Tone Leather Trim

— Available on Rubicon, Rubicon Unlimited, Sahara, and Sahara Unlimited

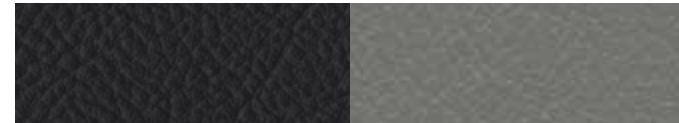

Dark Slate Gray/Medium Slate Gray



Dark Khaki /Medium Khaki



**16-inch** Black and Silver Aluminum

— Authentic Jeep Accessory by Mopar



**17-inch** Machined-Face, Black Pocket Aluminum Hulk

— Authentic Jeep Accessory by Mopar



**17-inch** Beadlock Rock Monster

— Authentic Jeep Accessory by Mopar



**17-inch** Machined Face, Black Pocket Cast Aluminum

— Authentic Jeep Accessory by Mopar



**17-inch** Black Painted Cast Aluminum

— Authentic Jeep Accessory by Mopar



**18-inch** 7-Spoke Chrome-Plated Cast Aluminum

— Authentic Jeep Accessory by Mopar

machraikd.com

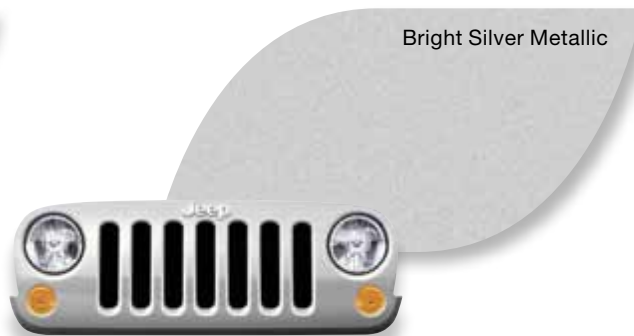
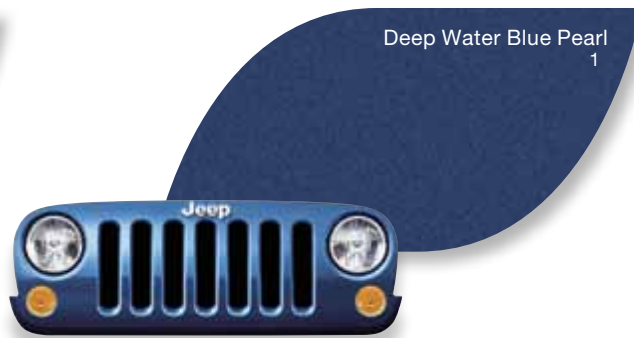

<sup>1</sup>Late availability on Sahara and Unlimited Sahara.

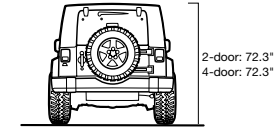
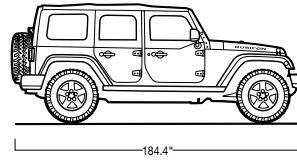
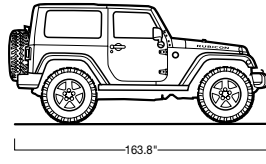
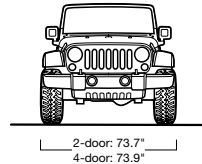
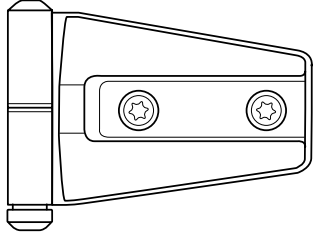

Note: Wrangler Rubicon specifications shown.

**POWERTRAIN**

**Engine** 3.8L SMPI V6  
**Displacement** (cu in) 230.5  
**Horsepower** (DIN @ rpm) 202 @ 5,000  
**Torque** (SAE net lb-ft @ rpm) 237 @ 4,000  
**Axle Ratio (:1)**  
 6-speed manual \_ 3.21 Std., 3.73 Opt., 4.10 Std. — Rubicon  
 4-speed automatic 3.73 Std., 4.10 Std. — Rubicon  
**Fuel System** Sequential multipoint, electronic fuel injection  
**Transmission**  
 6-speed manual with overdrive, synchronized in all gears, multirail shift system with top-mounted shift lever Std.  
 4-speed automatic with overdrive clutch hydraulic actuation, dual-mass flywheel system, electronically controlled converter clutch Opt.  
 (Std. on 2WD Unlimited models)  
**Overall Top Gear (:1)** 2.69 Std., 3.44 Std. — Rubicon

**ELECTRICAL SYSTEM**

**Alternator** 140 ampere  
**Battery** 600 CCA, maintenance-free  
**Fan** On-demand, 2-speed electric with thermally activated circuit breaker

**FOUR-WHEEL-DRIVE SYSTEM** (transfer case)

**NV241 GII Command-Trac®** (includes off-road skid plate), part-time, 2-speed, with shift-on-the-fly, 2.72:1 low-gear ratio Std. — All 4x4 models, except Rubicon  
**NV241 OR Rock-Trac®** (includes off-road skid plate), part-time, 2-speed, with shift-on-the-fly, 4.0:1 low-gear ratio Std. — Rubicon

**GEAR RATIO/CRAWL RATIO**

(manual transmission, standard axle ratio)

Model	Gear Ratio	First Transfer Case Axle Crawl Ratio		
		(4LO)	Ratio	Ratio
Rubicon	4.46	4.00	4.10	73.1
Unlimited Rubicon	4.46	4.00	4.10	73.1
Sahara	4.46	2.72	3.21	38.9
Unlimited Sahara	4.46	2.72	3.21	38.9
Sport	4.46	2.72	3.21	38.9
Unlimited Sport	4.46	2.72	3.21	38.9

**CAPACITIES/WEIGHTS/TOWING** (4WD)<sup>(1)</sup>

(pounds unless otherwise specified)  
**Fuel Tank** (includes off-road skid plate) (gal)  
 2-door/4-door 18.6/22.5  
**Base Curb Weight** 2-door, 4WD 3,849  
 4-door, 2WD/4WD 4,032/4,231  
**Payload Capacity** (all occupants and cargo) 1,000  
**Maximum Gross Vehicle Weight Rating** (when properly equipped)  
 2-door/4-door 5,000/5,500  
**Maximum Towing Capacity** (when properly equipped)  
 2-door/4-door Std. — 1,000  
 2-door with Trailer Tow Group/4-door with Trailer Tow Group Opt. — 2,000/3,500  
**Tongue Load Limit** 350

**BODY/SUSPENSION/CHASSIS**

**Body Design** Boxed steel frame with crushable, hydroformed front rail tips  
**Suspension** Live solid axles, 5-link front/rear, coil springs, leading arms, track/stabilizer bars and front steering damper  
**Front Sway Bar Disconnect System** Std. — Rubicon  
**Steering Type** Power, recirculating ball with damper  
**Overall Ratio** 2-door/4-door 16.7:1/ 14.7:1  
**Turns** (lock-to-lock) 2-door/4-door 3.5/3.1  
**Turning Diameter** (curb-to-curb, with P225/75R16 tires) (ft)  
 2-door/4-door 34.9/ 41.2  
**Brake System** 4-wheel disc hydraulic, power-assisted, 11.9" vented front/12.4" solid rear  
**Electronic Stability Control** 4-wheel disc antilock, with on- and off-road calibrations, 4-channel, active wheel-speed, vehicle-speed, steering-wheel-angle, yaw-rate and lateral-acceleration sensors, vehicle stability management with 3-stage activation switch, all-speed traction control, Brake Assist, Electronic Roll Mitigation and Electronic Brake Distribution  
**Hill Start Assist** Std

**INTERIOR DIMENSIONS** (inches unless otherwise specified)

**Seating Capacity** 2-door front/rear, 4-door front/rear 2/2, 2/3  
**Head Room** front 41.3  
 rear 40.3  
**Leg Room** front 41.0  
 rear, 2-door/4-door 35.6/37.2  
**Shoulder Room** front 55.8  
 rear, 2-door/4-door 61.6/56.8  
**Hip Room** front 55.6  
 rear, 2-door/4-door 44.7/56.7  
**Front-Seat Travel** 9.4  
**Front-Seat Volume Index** (cubic feet) 54.8  
**Rear-Seat Volume Index** (cubic feet), 2-door/4-door 48.3/48.4  
**Cargo Volume** (cubic feet)  
 rear seat folded and tumbled, 2-door 61.2  
 rear seat folded, 2-door/4-door 56.5/82.0  
 behind rear seat 2-door/4-door 17.2/46.4  
**Cargo Liftover Height** 2-door/4-door 27.8/31.4

**EXTERIOR DIMENSIONS** (inches unless otherwise specified)

**Wheelbase** 2-door/4-door 95.4/116.0  
**Overall Length** 2-door/4-door 163.8/184.4  
**Overall Width** 2-door/4-door 73.7/73.9  
**Track** front/rear 61.9/61.9  
**Height** 2-door/4-door 72.3/72.3  
**Ground Clearance** (at curb weight) (Rubicon) 10.3  
**Approach Angle** 2-door/4-door 44.3°/44.4°  
**Departure Angle** 2-door/4-door 40.4°/40.5°  
**Breakover Angle** 2-door/4-door 25.3°/20.8°

**RAMP TRAVEL INDEX (RTI)** (20-degree ramp)

**Rubicon** (sway bar connected/disconnected) 638/822  
**Unlimited Rubicon** (sway bar connected/disconnected) 484/644

<sup>(1)</sup> Be sure to follow all instructions in Owner's Manual for trailer towing. For specific details, discuss your plans with your Jeep dealer, who will help you select the right equipment to meet your specifications.

All product illustrations and specifications are based upon current information at the time of publication approval. Although descriptions are believed correct, accuracy cannot be guaranteed. Chrysler Group LLC reserves the right to make changes at any time without notice or obligation in prices, specifications, colors and materials, and to change or discontinue models. Some of the equipment shown or described throughout this catalog is available at extra cost. Available in U.S. markets only. See your dealer for the latest information.

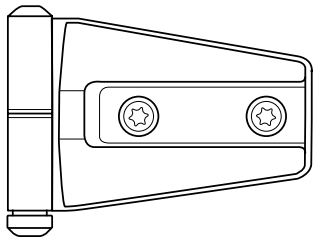



4WD			2WD OR 4WD			4WD		
WRANGLER			WRANGLER UNLIMITED					
SPORT	SAHARA	RUBICON	SPORT	SAHARA	RHD	RUBICON		
B	S	G	R	C	S	G	U	R

**CAPABILITY**

<b>Axle</b> — Next Generation Dana 44 heavy-duty solid rear	•	•	•	•	•	•	•	•	•
— Next Generation Dana 30 solid front (4WD models)	•	•	•		•	•	•	•	
— Next Generation Dana 44 heavy-duty solid front				•					•
<b>Axle Ratio</b> — 3.21:1 (requires manual transmission) (3.73:1 axle ratio standard on 2WD models)	•	•	•		•	•	•		
— 3.73:1 (included with Trailer Tow Group or 4-speed automatic transmission)	O/P	O/P	O/P		O/P	O/P	O/P	•	
— 4.10:1				•					•
<b>Differentials</b> — Trac-Lok® limited-slip rear (requires Dana 44 heavy-duty rear axle)		O	O		O	O	O	O	
— Tru-Lok® front and rear, electronic remote locking				•					•
<b>Four-Wheel-Drive System</b> (4WD models) — Command-Trac® NV241 GII, manual, part-time, shift-on-the-fly transfer case	•	•	•		•	•	•	•	
— Rock-Trac® NV241 OR, manual, part-time, shift-on-the-fly transfer case				•					•
<b>Powertrain</b> — 3.8L V6 SMPI engine with 6-speed manual transmission (excludes 2WD models)	•	•	•	•	•	•	•	•	•
— 3.8L V6 SMPI engine with 4-speed automatic transmission (standard on 2WD models)	O	O	O	O	O	O	O	•	O
<b>Rock Rails</b> — Black, painted steel, heavy-duty, protective, body-mounted				•					•
<b>Skid Plates</b> — Protective; fuel tank (2.5-mm), transfer case (3.5-mm) (if equipped), 4-speed automatic transmission (4-mm) (if equipped)	•	•	•	•	•	•	•	•	•
<b>Sway Bar Disconnect</b> — Electronically controlled, front				•					•
<b>Tow Hooks</b> — Two front, one rear	•	•	•	•	•	•	•	•	•
<b>Trailer Tow Group</b> — Includes Class II receiver hitch, seven-to-four-pin adapter, Trailer Sway Control, and 3.73:1 axle ratio. (Class I receiver hitch on 2-door models)		O	O	O	O	O	O	O	O

**EXTERIOR**

<b>Air Dam</b> — Removable, front	•	•	•	•	•	•	•	•	•
<b>Doors</b> — Removable, half-framed metal with plastic windows (requires soft top, not available with power windows or doors)		O		O	O	O			O
— Removable, full-framed metal with actuating glass windows	•	•	•	•	•	•	•	•	•

4WD			2WD OR 4WD			4WD		
WRANGLER			WRANGLER UNLIMITED					
SPORT	SAHARA	RUBICON	SPORT	SAHARA	RHD	RUBICON		
B	S	G	R	C	S	G	U	R

**EXTERIOR (Continued)**

<b>Fender Flares</b> — Black, molded-in-color	•	•		•	•	•		•	•
— Body-color, molded-in-color			•				•		
<b>Glass</b> — Deep-tinted sunscreen rear and quarter		O	•	O		•	•		•
<b>Grille</b> — Body-color, painted, stone- and dent-resistant	•	•	•	•	•	•	•	•	•
<b>Lighting</b> — Halogen headlamps, impact-resistant	•	•	•	•	•	•	•	•	•
— Two halogen fog lamps, located in front bumper	•	•	•	•	•	•	•	•	•
<b>Steps</b> — Tubular side steps, diamond plate surface pattern		O	•			O	•		
<b>Tires</b> — P225/75R16 Goodyear Wrangler ST, BSW on-/off-road	•				•				•
— P255/75R17 Goodyear Wrangler SR-A, OWL, on-/off-road		•				•			
— P255/70R18 Bridgestone Dueler A/T, OWL, on-/off-road			•				•		
— LT255/75R17 BF Goodrich® Mud Terrain, BSW, off-road				•					•
<b>Tops</b> — Sunrider® easy-folding soft-top with sunroof feature	•	•	•	•	•	•	•	•	•
— Freedom Top® three-piece modular hardtop with rear wiper/washer, rear defroster, full-framed doors and deep-tinted glass	O	O	O	O	O	O	O	•	O
— Dual-Top Group, includes Freedom Top hardtop and Sunrider Soft Top		O	O	O		O	O		O

**INTERIOR**

<b>Air Conditioning</b> <sup>(1)</sup> — Manual temperature controls	O	•	•	•	•	•	•	•	•
<b>Console</b> — Full-floor with front and rear cup holders, locking storage with drop-in bin and armrest	•	•	•	•	•	•	•	•	•
<b>Floor Mats</b> — Front, carpeted	•	•	•	•					
— Front and rear, carpeted					•	•	•	•	•
<b>Gauges</b> — Compass, temperature and mini-trip display (includes average fuel economy, distance to empty or elapsed time)	•	•	•	•	•	•	•	•	•
<b>Lighting</b> — Dome, sound-bar mounted with on/off switch and directional lighting	•	•	•	•	•	•	•	•	•
— Rear cargo with on/off switch					•	•	•	•	•
<b>Remote Start System</b> — Integrated key fob controls (requires Power Convenience Group and automatic transmission)			O	O			O		O
<b>Seating, Fabric</b> — Cloth, two-tone	•	•	•	•	•	•	•	•	•
— Leather-trimmed, two tone			O	O			O		O

4WD			2WD OR 4WD			4WD		
WRANGLER			WRANGLER UNLIMITED					
SPORT	SAHARA	RUBICON	SPORT	SAHARA	RHD	RUBICON		
B	S	G	R	C	S	G	U	R

4WD			2WD OR 4WD			4WD		
WRANGLER			WRANGLER UNLIMITED					
SPORT	SAHARA	RUBICON	SPORT	SAHARA	RHD	RUBICON		
B	S	G	R	C	S	G	U	R

### INTERIOR (Continued)

<b>Seats</b> Front — 4-way manual, driver's seat height adjuster with front seatback map pockets	•	•	•	•	•	•	•	•	•
Rear — Fold and Tumble seatback, removable	•	•	•	•					
— Split-folding 60/40 with self-articulating outboard head restraints				•	•	•	•	•	
<b>Steering Wheel</b> — Leather-wrapped, includes speed control (Sahara models add Satin Silver steering wheel spokes)		•	•	•		•	•	•	•
<b>Wash-Out Interior</b> — Removable front and rear carpet panels and drain plugs	•	•	•	•	•	•	•	•	•

### SAFETY AND SECURITY

<b>Air Bags</b> <sup>(*)</sup> — Advanced multistage driver and front-passenger	•	•	•	•	•	•	•	•	•
— Supplemental side front-seat mounted		○	○	○		○	○		○
<b>Brakes</b> — 4-wheel disc antilock with on-/off-road calibration	•	•	•	•	•	•	•	•	•
<b>Electronic Stability Control (ESC)</b> <sup>(*)</sup> — Includes Brake Assist, all-speed traction control, Electronic Roll Mitigation and on-/off-road brake lock differentials	•	•	•	•	•	•	•	•	•
<b>Hill Start Assist (HSA)</b> — Delays vehicle from rolling back when starting on an incline	•	•	•	•	•	•	•	•	•
<b>Sentry Key</b> <sup>®</sup> — Antitheft engine immobilizer	•	•	•	•	•	•	•	•	•

### UCONNECT™ MULTIMEDIA

<b>Media Center Radios</b> — Media Center 130 AM/FM/CD radio with MP3/WMA support and audio jack	•	•	•	•	•	•	•	•	•
— Media Center 230 AM/FM radio with 6 CD/DVD changer, MP3/WMA support and audio jack		○	○	○		○	○		○
— Media Center 730N CD/DVD <sup>(*)</sup> radio with MP3/WMA support, 30GB hard drive with 4,250 song capacity, 6.5-inch touch-screen, SIRIUS <sup>®</sup> Satellite Radio <sup>(*)</sup> audio jack, Voice Command, GPS navigation, SIRIUS Traffic <sup>™</sup> and Uconnect Phone			○	○			○		○
<b>Audio Systems</b> — 6 speakers	•	•			•	•		•	
— 7 ∞Infinity speakers including subwoofer and 368-watt amplifier		○	•	•	○	○	•		•
<b>SIRIUS Satellite Radio</b> — Includes 1-year subscription		○	•	•		○	•		•
<b>Uconnect Phone</b> — Hands-free calling with Address Sync <sup>(*)</sup> , Bluetooth <sup>(*)</sup> and Voice Command (included with Media Center 730N)			○	○			○		○
<b>Uconnect Web</b> — Internet connection and Wi-Fi Hotspot. Dealer-installed Authentic Jeep Accessory by Mopar. Subscription required, sold separately	○	○	○	○	○	○	○	○	○

### PACKAGES

<b>Black Appearance Group</b> — Includes black tubular side steps, black fuel filler door, and black taillamp guards (Authentic Jeep Accessory by Mopar)	○	○			○	○			
<b>Chrome Edition Group</b> — Includes chrome tubular side steps, chrome exhaust tip, chrome fuel filler door and chrome taillamp guards (not available with Black Appearance Group) (Authentic Jeep Accessory by Mopar)	○	○			○	○	○		
<b>Premium Chrome Group</b> — Includes chrome exterior mirror caps and chrome grille (requires Chrome Edition Group) (Authentic Jeep Accessory by Mopar)							○		
<b>Power Convenience Group</b> — Power locks, power windows with front one-touch down operation, remote keyless entry system and security alarm (requires full-framed doors)		○	•	○		•	•	•	•
<b>Smoker's Group</b> — Removable ashtray and lighter element	○	○	○	○	○	○	○	○	○

• = Included. ○ = Available within package noted. ○ = Optional.

<sup>(\*)</sup> There are special cooling requirements for non-factory-installed air conditioning. Failure to follow these requirements may invalidate warranty.

<sup>(\*)</sup> Certified to the Federal regulations that allow less forceful front air bags. Always use seat belts. Children 12 and under should always be in a backseat correctly using an infant or child restraint system, or with the seat belt positioned correctly for the child's age and weight.

<sup>(\*)</sup> No system, no matter how sophisticated, can repeal the laws of physics or overcome careless driving actions. Performance is limited by available traction, which snow, ice and other conditions can affect. When the ESC warning lamp in the speedometer flashes, the driver needs to use less throttle and adapt speed and driving behavior to prevailing road conditions. Always drive carefully, consistent with conditions. Always wear your seat belt.

<sup>(\*)</sup> In-dash DVD capability not available in all states. See your dealer for details.

<sup>(\*)</sup> SIRIUS U.S. Service available only in contiguous United States and D.C. Service available in Canada; see siriuscanada.ca. Subscription required after 12-month subscription included with vehicle purchase. Subscriptions governed by SIRIUS Terms & Conditions available at sirius.com. SIRIUS, XM, and all related marks and logos are trademarks of SIRIUS XM Radio Inc. and its subsidiaries.

<sup>(\*)</sup> The Uconnect Web feature is not intended for use by the driver while it's in motion.

Jeep, Wrangler, Command-Trac, Freedom Top, Mopar, Rock-Trac, Trac-Lok, Trail Rated, Sentry Key, Tru-Lok, and the Jeep grille are registered trademarks and Go Anywhere, Do Anything and Uconnect are trademarks of Chrysler Group LLC. Bluetooth is a registered trademark of Bluetooth SIG, Inc. ∞Infinity is a registered trademark of Harman International Industries, Inc. Sunrider is a registered trademark of Bestop, Inc. SIRIUS service available only in contiguous United States and D.C. Service available in Canada; see siriuscanada.ca. Subscription required after 12-month subscription included with vehicle purchase. Subscriptions governed by SIRIUS Terms & Conditions available at sirius.com. SIRIUS, XM, and all related marks and logos are trademarks of SIRIUS XM Radio Inc. and its subsidiaries. iPod is a registered trademark of Apple, Inc. All rights reserved.

machaikdcj.com

**Jeep** Jamboree USA offers off-road adventure weekends that bring together the outdoors, down-to-earth people and their Jeep 4WD vehicles. We invite you to explore America's remote back-country, where great friendships and memories are made. [jeep.com/jamboree](http://jeep.com/jamboree)



Explore an extensive line of gifts and gear for the Jeep enthusiast. From authentic wearables and sports equipment to electronics, all items are as rugged and durable as your Jeep vehicle. [jeep.com/gear](http://jeep.com/gear)

Find us on **Facebook**



Jeep owners have been waving at each other on the road from the start. Now they're sharing the love in the wider world of the Internet. From the Jeep experience site to our Jeep Facebook™ Page, you can join fellow Jeep enthusiasts

by posting comments, participating in discussions, or sharing your Jeep photos and videos. Become a member of the club. The community is gathering online. [jeep.com/experience](http://jeep.com/experience)

# The difference between talking and **doing...**

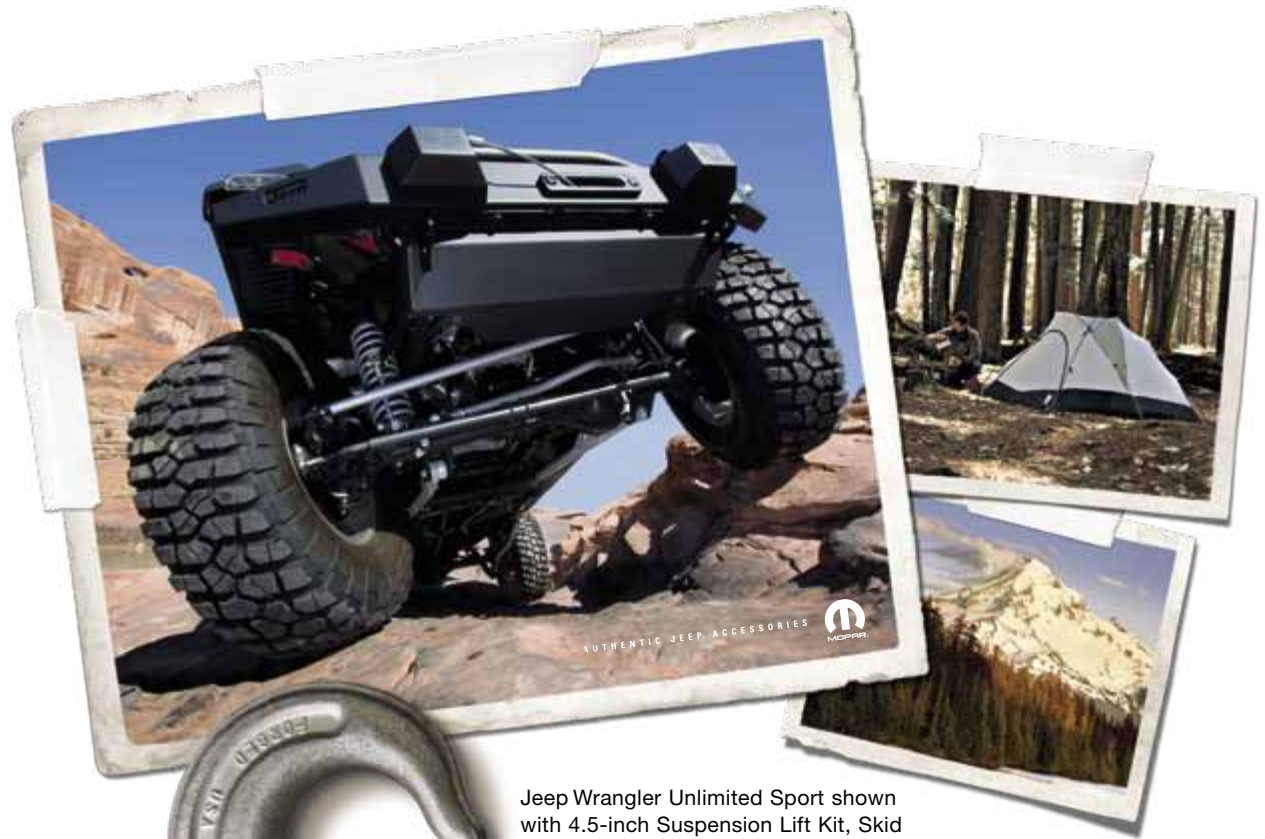

Jeep Wrangler Unlimited Sport shown with 4.5-inch Suspension Lift Kit, Skid Plate and Front Off-Road Bumper. Authentic Jeep Accessories by Mopar.

[machaikdcj.com](http://machaikdcj.com)

**Friendly Dealerships** offer knowledgeable staff who are professionally trained to guide you with expert advice.

**Visit [jeep.com](http://jeep.com)** for all the latest information you'll need to be properly equipped for an educated buying decision.

**Call (800) 925-JEEP** to speak with one of our Jeep® brand customer service representatives for the right answers to your important questions.

**5-Year/100,000-Mile Powertrain Warranty**  
Transferable. See dealer for a copy of limited warranty. Includes towing to an authorized dealer.

**Warranty** Jeep vehicles are covered by a Chrysler Group LLC 3-year or 36,000-mile Basic Limited Warranty. See your dealer for a copy of this limited warranty. Excludes normal maintenance and wear items.

**Jeep Auto Insurance**<sup>(1)</sup> The only insurance guaranteed to repair your vehicle using Authentic Jeep Collision Repair Parts by Mopar for as long as you own your vehicle — at rates that are tough to beat. Plus, get up to \$100<sup>(2)</sup> in deductible waived when repairs are done at a Jeep dealership. For a quote, call (877) 244-1531 or visit [cf.com/insurance](http://cf.com/insurance).

**Chrysler Service Contracts** Chrysler has a vested interest in your satisfaction with your new Jeep vehicle. Chrysler Service Contracts offer extended service plans to help ensure that you'll enjoy your vehicle for many years down the road — for just pennies a day. For more information, see your Jeep dealer, call (800) 442-2666 or visit [jeep.com/csc](http://jeep.com/csc).

**Authentic Jeep Accessories by Mopar** are designed specifically for your Jeep vehicle for exceptional fit, finish, and performance. Visit your dealership or [mopar.com](http://mopar.com).

**Uconnect™** With Uconnect, you're always connected — to people, places, music, movies, and the Internet.

**SIRIUS® Satellite Radio** delivers over 130 channels, including 100% commercial-free music, sports, news, talk, entertainment, traffic, and weather. Factory-installed SIRIUS Satellite Radio includes a one-year subscription. For more information, go to [sirius.com](http://sirius.com).

**Trail Rated®** An authentic Jeep brand Trail Rated badge is a visual reminder of the capabilities built in — the symbol of a genuine, tried-and-true Jeep 4x4. Accept no substitutes.

**Tread Lightly!®** As a founding member and official partner, we urge all Jeep owners to follow Tread Lightly! Guidelines. To learn more, call (800) 966-9900 or visit [treadlightly.org](http://treadlightly.org).

**Honoring Those Who Serve** Chrysler Group LLC proudly supports the members of the U.S. Armed Forces and their families.

<sup>(1)</sup>Insurance provided through 21st Century Insurance and Financial Services, Wilmington, DE, managing general agent for the personal lines insurers of American International Companies. <sup>(2)</sup>Coverage features and availability may vary by state.

All product illustrations, specifications and competitive comparisons are based upon current information at the time of publication approval. Although descriptions are believed correct, complete accuracy cannot be guaranteed. Chrysler Group LLC reserves the right to make changes at any time, without notice or obligation, in prices, specifications, equipment, colors and materials, and to change or discontinue models. Some of the equipment shown or described throughout this catalog is available at extra cost. Available in U.S. markets only. See your dealer for the latest information.

**5 YEAR/100,000 MILE**  
**POWERTRAIN WARRANTY**



[machaikdcj.com](http://machaikdcj.com)

(800) 925-JEEP [jeep.com](http://jeep.com)

Jeep is a registered trademark of Chrysler Group LLC.