

2015 VOLVO FLEET



DESIGNED AROUND YOU

Volvo. Designed Around You



With over 15 years as an active supplier of commercial fleet vehicles, Volvo is committed to providing our customers with a premium fleet experience.

Volvo offers:

Drive E Power Trains

We offer class leading fuel economy with no compromise on performance and emissions.

Exceptional Value

Over the years several Volvo models have been recognized by Vincentric™ as among the best fleet values thanks to their low total cost of ownership. Most significantly, the Volvo XC60 has won the Vincentric™ award as the "Best Fleet Value in America" for 2010, 2011 and 2012.

Safety Leadership

Volvo's promise to you is that everything we do at Volvo is safety. Every day we are focused on supporting and protecting you.

Life Less Complicated

Wherever your fleet drivers are located, there is a fleet-minded Volvo dealer nearby. We also offer Complimentary Factory Scheduled Maintenance up to 30,000 miles.



Table of Contents

You Are Important

Volvo enhances fleet customer treatment and satisfaction by providing consistent order-to-delivery times with priority order placement at the factory; direct-order relationships with major fleet leasing companies; and premium courtesy delivery at the customer's nearest Volvo Retailer.

To reinforce your corporate image; enhance your executive selector; and improve recruitment, reward and retention efforts at your organization, we encourage you to consider Volvo for your fleet needs.

- The Volvo Fleet Experience 2, 3
- Comparison Chart 4
- Why Use Volvo Fleet 5
- S60 6, 7
- V60 8, 9
- XC60 10, 11
- XC70 12, 13
- S80 14, 15
- XC90 16, 17
- Volvo Safety 18, 19
- Accessories (Port-Installed) 20
- Environmental Care 21
- Contact Information 22
- Factory Scheduled Maintenance (FSM) 22
- A-Plan By Volvo 23



Note: Specifications, features and equipment shown in this catalog are based upon the latest information at the time of publication. Volvo Cars of North America, LLC reserves the right to make changes at any time, without notice, to colors, specifications, accessories, materials and models. For additional information, please contact the Fleet Sales Department at 1 (877) 283-5338 or for Canada (416) 268-0235. ©2014 Volvo Cars of North America, LLC. Printed in USA.

COMPARISON CHART

Volvo Fleet Selector Positioning Chart



2015 VOLVO S60

Ford Taurus SEL
Buick Lacrosse L
Chevrolet Impala LTZ
Chrysler 300 S
Toyota Avalon
Audi A4



2015 VOLVO S80

Audi A6
Cadillac CTS
Lincoln MKZ
Mercedes-Benz E Class
Infiniti G37



2015 VOLVO V60

Subaru Outback
Audi Allroad
Acura TSX Sports Wagon
BMW 3 Touring



2015 VOLVO XC60

Buick Enclave
Chevrolet Traverse LT
Ford Edge SEL
GMC Acadia SL
Ford Explorer XLT



2015 VOLVO XC70

Buick Enclave
Chevrolet Traverse LT
Ford Edge SEL
GMC Acadia SL
Ford Explorer XLT



2014 VOLVO XC90

GMC Acadia SLT
Cadillac SRX
Ford Explorer
Lexus RX
Lincoln MKX
Buick Enclave L

WHY VOLVO FLEET?



VOLVO FLEET

Designed Around You



DEALER NETWORK

Wherever your fleet drivers are located, there is a fleet-minded Volvo dealer nearby and ready to deliver our Premium Fleet Experience. We offer complete major market coverage across North America. Our exceptionally stable dealer network is here today and here tomorrow to serve your needs.

LEGENDARY SAFETY

Volvo means safety. It begins with our Volvo Safety Center in Gothenburg, the most technologically advanced crash-test facility in the world. Most recently, we have pioneered such landmark safety features as City Safety – Forward Collision Warning System with Full Auto Brake, and Distracted Driver Solutions.

PRODUCT RANGE

Volvo's range of cars is now wider than ever, from our dynamic Volvo S60 sedan and V60 sports wagon, to our flagship Volvo S80 sedan, to our versatile crossovers, the Volvo XC90, XC60 and XC70. The Volvo lineup is sure to fit every level of your organization, from general use to management and executives.

FLEET TEAM

Volvo has been in the fleet business for over thirteen years with an experienced fleet management team leading the way. Our fleet business is rapidly growing as a result of our commitment to deliver an unmatched combination of product quality and personal service to our fleet clients.

INTERNATIONAL REACH

Should you require help coordinating fleet needs worldwide, Volvo is there. Our international network of operating units ensures your buying power is maximized.

LIFECYCLE COSTS

We are committed to helping you manage the acquisition, maintenance and depreciation costs of your fleet vehicles. The high residual values on our vehicles helps control depreciation costs, especially with a Volvo New Car Warranty that provides comprehensive coverage for 4 years or 50,000 miles (whichever comes first). Our team is focused on providing a low cost of ownership during the lifecycle of the vehicles in your fleet.

2015

S60

S60

Engine	2.0L T5	2.5L T5	2.0L T6	3.0L T6 R-Design
Engine Type Description	4-cylinder Turbocharged	5-cylinder Turbocharged	4-cyl. Supercharged Turbo	6-cylinder Turbocharged
Drivetrain	FWD	FWD	FWD	AWD
Number of Cylinders	4	5	4	6
CO ₂ /km	TBD	184 g	TBD	212 g
Horsepower	240 hp	250 hp	300 hp	325 hp
Torque	258 lb-ft	266 lb-ft	295 lb-ft	354 lb-ft
Fuel	Reg. gas (87 octane)	Reg. gas (87 octane)	Premium Fuel	Reg. gas (87 octane)
Transmission	8-Speed Automatic	6-Speed Automatic	8-Speed Automatic	6-Speed Automatic

FUEL ECONOMY

MPG (Highway)	37 mpg	29 mpg	35 mpg	28 mpg
MPG (Combined)	29 mpg	23 mpg	28 mpg	22 mpg

SPECIFICATIONS

Dimensions†	(IN.)
Wheelbase	109.3
Length	182.2
Height	58.4
Width	73.4
Headroom (front/rear)	38.3/37.4
Shoulder room (front/rear)	57.0/55.2
Hip room (front/rear)	54.9/53.5
Leg room (front/rear)	41.9/33.5

Capacities	
Cargo volume (cu. ft.)	12.0
Fuel capacity (gal.)	17.8
Passenger volume (cu. ft.)	93.0

EXTERIOR‡

Ice White	Flamenco Red (M)
Ember Black (M)	Caspian Blue (M)
Electric Sliver (M)	Saville Grey (M)
Black Stone	Seashell (M)

M = Metallic

INTERIOR

Offblack Leather	Optional T5
Soft Beige Leather	Optional T5
Charcoal Black	Textile

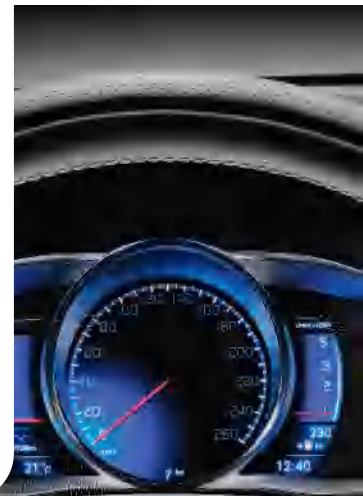

2013 IIHS TOP SAFETY PICK+[†]

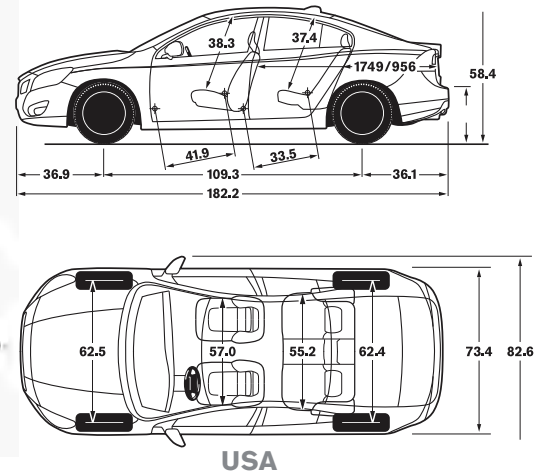
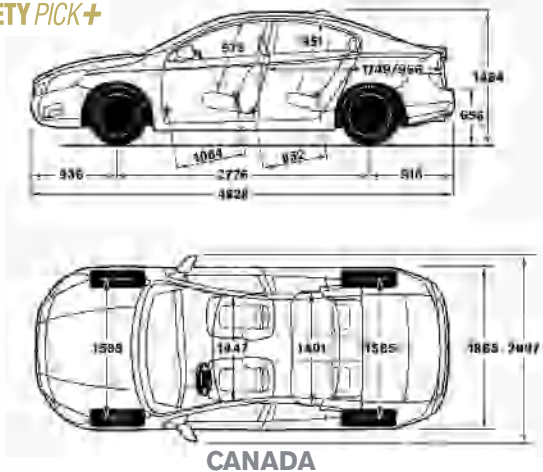

KEY HIGHLIGHTS

- Complimentary Factory Scheduled Maintenance: The first three regularly scheduled maintenance services at 10,000, 20,000 & 30,000 mileage intervals* (not available in Canada)
- 4-year/50,000-mile limited warranty w/4-year/unlimited miles roadside assistance standard*
- City Safety – Forward Collision Warning System with Full Auto Brake
- Pedestrian Detection w/Full Auto Brake available

MAJOR STANDARD EQUIPMENT

- 8-speed Geartronic™ Automatic Transmission with Sport Mode
- 17" Alloy Wheels
- AWD w/Instant Traction (available)
- Dynamic Stability & Traction Control (DSTC) w/Sport Mode
- Advanced Stability Control (ASC)
- Corner Traction Control by Torque Vectoring (CTC)
- Bluetooth® Technology w/Audio Streaming
- Driver Control Interface w/7" Hi Res Color Display w/Steering Wheel Controls
- Dual Zone Electronic Climate Control
- Cruise Control
- High Performance Multimedia Audio System with HD Radio, In-Dash Single CD Player and AM/FM Stereo
- USB/Aux Input/iPod®
- SIRIUS Satellite Radio w/complimentary 6 month subscription
- Analog Instruments
- Adjustable (telescopic & height) Leather Steering Wheel w/Silk Metal Inlays & Controls
- Trip Computer
- Leather Gearshift Knob

- Power Driver's Seat 8-way w/Adjustable Lumbar, 3-Position Memory, Passenger Seat
- Power Foldable Rear Headrests
- 40/60 Split Rear Seats
- Tire Pressure Monitoring System (TPMS)
- Integrated Tailpipe
- Shimmer Graphite Aluminum Inlays
- Power Windows w/Driver & Passenger Auto Up/Down & Anti-Trap Feature
- Power Heated Outer Mirrors
- Puddle Lights
- Halogen Headlights
- LED Daytime Running Lights
- Side Positioning Lights
- Rear Fog Light w/Auto-Off
- Home Safe & Approach Lighting

STANDARD SAFETY & SECURITY

- City Safety – Forward Collision Warning System with Full Auto Brake
- Side Impact Protection System (SIPS)
- Whiplash Protection System (WHIPS)
- Emergency Brake Assist (EBA)
- Anti-Lock Brake System (ABS) w/Electronic Brake Assist (EBA)
- Driver & Passenger Supplemental Restraint System – Three Step Air Bags
- Inflatable Side Curtain (IC)
- ISOFIX Baby/Child Seat Attachment System
- Side-Impact Air Bags for Driver & Front Passenger
- Immobilizer, Encrypted Ignition Key
- Security Alarm
- Seatbelts: 5, 3-point Inertia-Reel Belts w/Automatic Pre-tensioners
- Intelligent Driver Information System
- Rain Sensor
- Tunnel Detection

MAJOR OPTIONAL EQUIPMENT

- Park Assist Pilot
- Blind Spot Information System (BLIS) with Cross-Traffic Alert & Front & Rear Park Assist
- Urbane Wood Inlays
- Metallic Paint
- Accessory Prep Cable
- Active Dual Xenon Headlight w/Headlight Washers
- Heated Front Seats
- Fleet Value, Leather Only (S60 T5 Only)

OPTIONAL PACKAGES

- Premier (T5) Trim
 - Power Glass Moonroof
 - 17" SADID Alloy Wheels
 - Leather Seating Surfaces
 - Auto Dimming Rearview Mirror
 - Personal Car Communicator w/Keyless Drive
 - Metallic Paint
 - Adaptive Digital Display
- Climate Package
- Technology Package
 - Adaptive Cruise Control w/Queue Assist
 - Collision Warning w/Full Auto Brake
 - Pedestrian & Cyclist Detection w/Full Auto Brake
 - Distance Alert
 - Driver Alert Control
 - Lane Departure Warning (some models)
 - Road Sign Information
 - Active Highbeams

VEHICLE LEVELS

- Premier
- Premier Plus
- Platinum

*See your local retailer for details.

† Dimensions shown may vary due to optional features and/or production variability.

‡ Volvo uses clearcoat paint for protection and beauty. All colors may not be available on all series.

For specific Canadian information, please contact the Volvo fleet manager in Toronto.

2015

V60

V60

Engine	2.0L T5	2.5L T5 AWD	3.0L T6 R-Design
Engine Type Description	4-cylinder Turbocharged	5-cylinder Turbocharged	6-cylinder Turbocharged
Drivetrain	FWD	FWD	AWD
Number of Cylinders	4	5	6
CO ₂ /km	TBD	184 g	240 g
Horsepower	240 hp	250 hp	325 hp
Torque	258 lb-ft	266 lb-ft	295 lb-ft
Fuel	Reg. gas (87 octane)	Reg. gas (87 octane)	Reg. gas (87 octane)
Transmission	8-Speed Automatic	6-Speed Automatic	6-Speed Automatic

FUEL ECONOMY

MPG (Highway)	39 mpg	29 mpg	28 mpg
MPG (Combined)	29 mpg	23 mpg	22 mpg

SPECIFICATIONS

Dimensions[†] (IN.)

Wheelbase	109.3
Length	182.5
Height	58.4
Width	73.4
Headroom (front/rear)	39.3/37.5
Shoulder room (front/rear)	57.0/55.2
Hip room (front/rear)	54.9/53.5
Leg room (front/rear)	41.9/33.5

Capacities

Cargo volume (cu. ft.)	43.8
Fuel capacity (gal.)	17.8

EXTERIOR[‡]

Ice White	Flamenco Red (M)
Ember Black (M)	Caspian Blue (M)
Electric Sliver (M)	Saville Grey (M)
Black Stone	Seashell (M)
M = Metallic	

INTERIOR

Offblack Leather	Optional T5
Soft Beige Leather	Optional T5
Charcoal Black	Textile



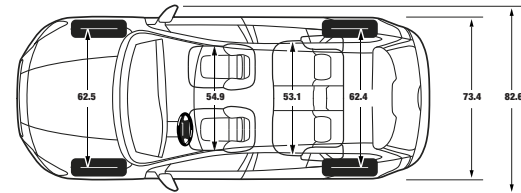
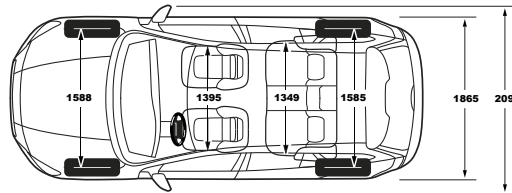
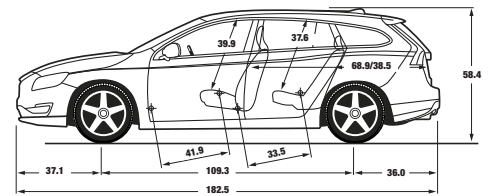
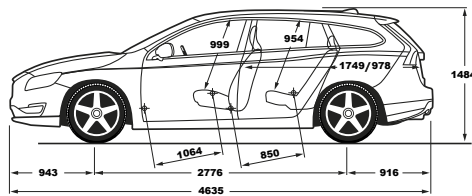

CANADA

USA

KEY HIGHLIGHTS

- Complimentary Factory Scheduled Maintenance: The first three regularly scheduled maintenance services at 10,000, 20,000 & 30,000 mileage intervals* (not available in Canada)
- 4-year/50,000-mile limited warranty w/4-year/unlimited miles roadside assistance standard*
- City Safety – Forward Collision Warning System with Full Auto Brake
- Pedestrian Detection w/Full Auto Brake available

MAJOR STANDARD EQUIPMENT

- 8-speed Geartronic™ Automatic Transmission with Sport Mode
- 17" Alloy Wheels
- AWD w/Instant Traction (available)
- Dynamic Stability & Traction Control (DSTC) w/Sport Mode
- Advanced Stability Control (ASC)
- Corner Traction Control by Torque Vectoring (CTC)
- Bluetooth® Technology w/Audio Streaming
- Driver Control Interface w/7" Hi Res Color Display w/Steering Wheel Controls
- Electronic Climate Control
- Cruise Control
- High Performance Multimedia Audio System with HD Radio, In-Dash Single CD Player and AM/FM Stereo
- USB/Aux Input/iPod®
- SIRIUS Satellite Radio w/complimentary 6 month subscription
- Analog Instruments
- Adjustable (telescopic & height) Leather Steering Wheel w/Silk Metal Inlays & Controls
- Trip Computer
- Power Glass Moonroof
- Brake Energy Regeneration

- Leather Gearshift Knob
- Power Driver's Seat 8-way w/Adjustable Lumbar, 3-Position Memory, Passenger Seat
- Power Foldable Rear Headrests
- 40/20/40 Split Folding Rear Seats
- Tire Pressure Monitoring System (TPMS)
- Integrated Tailpipe
- Shimmer Graphite Aluminum Inlays
- Power Windows w/Driver & Passenger Auto Up/Down & Anti-Trap Feature
- Power Heated Outer Mirrors
- Puddle Lights
- Halogen Headlights
- LED Daytime Running Lights
- Side Positioning Lights
- Rear Fog Light w/Auto-Off
- Home Safe & Approach Lighting

STANDARD SAFETY & SECURITY

- City Safety – Forward Collision Warning System with Full Auto Brake
- Side Impact Protection System (SIPS)
- Whiplash Protection System (WHIPS)
- Emergency Brake Assist (EBA)
- Anti-Lock Brake System (ABS) w/Electronic Brake Assist (EBA)
- Driver & Passenger Supplemental Restraint System – Three Step Air Bags
- Inflatable Side Curtain (IC)
- ISOFIX Baby/Child Seat Attachment System
- Side-Impact Air Bags for Driver & Front Passenger
- Immobilizer, Encrypted Ignition Key
- Security Alarm
- Seatbelts: 5, 3-point Inertia-Reel Belts w/Automatic Pre-tensioners
- Intelligent Driver Information System
- Rain Sensor
- Tunnel Detection

MAJOR OPTIONAL EQUIPMENT

- Park Assist Pilot
- Blind Spot Information System (BLIS) with Cross-Traffic Alert & Front & Rear Park Assist
- Urbane Wood Inlays
- Metallic Paint
- Dual Booster Seats
- Accessory Prep Cable
- Active Dual Xenon Headlight w/Headlight Washers
- Heated Front Seats
- Fleet Value, Leather Only

OPTIONAL PACKAGES

- Premier (T5) Trim
 - 17" SADID Alloy Wheels
 - Leather Seating Surfaces
 - Auto Dimming Rearview Mirror
 - Personal Car Communicator w/Keyless Drive
 - Metallic Paint
 - Silver Roof Rails
 - Adaptive Digital Display
- Climate Package
- Technology Package
 - Adaptive Cruise Control w/Queue Assist
 - Collision Warning w/Full Auto Brake
 - Pedestrian & Cyclist Detection w/Full Auto Brake
 - Distance Alert
 - Driver Alert Control
 - Lane Departure Warning
 - Road Sign Information
 - Active Highbeams

VEHICLE LEVELS

- Premier
- Premier Plus
- Platinum

*See your local retailer for details.

† Dimensions shown may vary due to optional features and/or production variability.

‡ Volvo uses clearcoat paint for protection and beauty. All colors may not be available on all series.

For specific Canadian information, please contact the Volvo fleet manager in Toronto.

2015

XC60

XC60

Engine	2.0L T5	3.2L PZEV	2.0L T6	3.0L T6 AWD	3.0L T6 R-Design
Engine Type Description	4-cylinder Turbo	In-Line 6-cylinder	4-cyl. Supercharged Turbo	6-cylinder Turbo	6-cylinder Turbo
Drivetrain	FWD	AWD	FWD	AWD	AWD
Number of Cylinders	4	6	4	6	6
CO ₂ /km	TBD	221 g	TBD	240 g	240 g
Horsepower	240 hp	240/230 hp	300 hp	300 hp	325 hp
Torque	258 lb-ft	236 lb-ft	295 lb-ft	295 lb-ft	295 lb-ft
Fuel	Reg. gas (87 octane)	Reg. gas (87 octane)	Premium Fuel	Reg. gas (87 octane)	Reg. gas (87 octane)
Transmission	8-Speed Automatic	6-Speed Automatic	8-Speed Automatic	6-Speed Automatic	6-Speed Automatic

FUEL ECONOMY

MPG (Highway)	31 mpg	25 mpg	30 mpg	24 mpg	24 mpg
MPG (Combined)	27 mpg	20 mpg	25 mpg	20 mpg	20 mpg

SPECIFICATIONS

Dimensions†	(IN.)
Wheelbase	109.2
Length	182.2
Height	67.4
Width	74.4
Headroom (front/rear)	38/38.1
Shoulder room (front/rear)	56.7/55.2
Hip room (front/rear)	54.2/53.8
Leg room (front/rear)	41.2/36.4

Capacities

Cargo capacities (cu. ft.)	67.4
Fuel capacity (gal.)	18.5

EXTERIOR‡

Black Stone	Ice White
Saville Grey (M)	Twilight Bronze (M)
Black Sapphire (M)	Caspian Blue (M)
Seashell (M)	Flamenco Red (M)
Passion Red (R-Design)	Electric Silver (M)
Rebel Blue (R-Design)	M = Metallic

INTERIOR

Textile: Offblack
Leather: Offblack, Soft Beige





5 Star Crash Rating

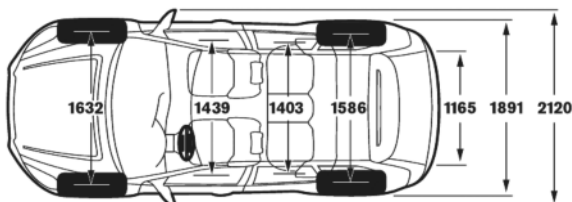
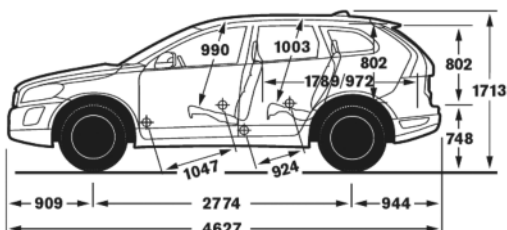

CANADA

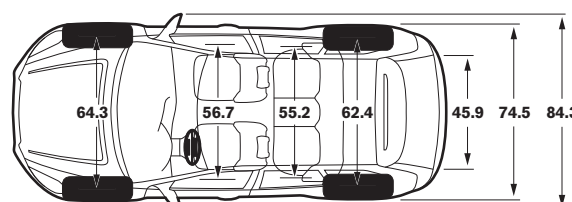
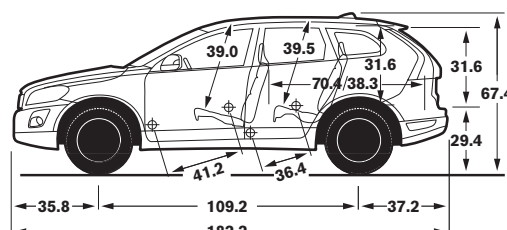

USA

KEY HIGHLIGHTS

- Complimentary Factory Scheduled Maintenance: The first three regularly scheduled maintenance services at 10,000, 20,000 & 30,000 mileage intervals* (not available in Canada)
- 4-year/50,000-mile limited warranty w/4-year/unlimited miles roadside assistance, standard*
- City Safety—Forward Collision Warning System with Full Auto Brake
- Pedestrian Detection w/Full Auto Brake available
- 2010, 2011 & 2012 Vincentric Best Fleet Value in America Award Winner

MAJOR STANDARD EQUIPMENT

- 8-speed Geartronic™ Automatic Transmission
- 18" PAN Alloy Wheels
- High Performance Audio System with HD Radio In-Dash Single CD Player and AM/FM Stereo
- USB & iPod® Inputs
- SIRIUS Satellite Radio w/complimentary 6 month subscription
- Driver Control Interface w/7" Hi Res Color Display w/Steering Wheel Controls
- Bluetooth® Technology w/Audio Streaming
- Cruise Control
- Analog Instruments
- Intelligent Driver Information System (IDIS)
- Trip Computer w/Outside Temperature Gauge
- Dual Zone Electronic Climate Control (ECC) w/Pollen Filter
- Power-Adjustable Front Seats, 8-way w/Adjustable Lumbar, Driver's w/3-position Memory, Passenger Seat
- AWD available
- 40/20/40 Split-Folding Rear Seat
- Shimmer Graphite Aluminum Inlays

- Lockable Underfloor Storage & Cargo Area
- Leather Steering Wheel w/Remote Audio Controls
- Leather Gear Shift Knob
- Power Windows w/Driver & Passenger Auto Up/Down w/Anti-Trap Feature
- Tire Pressure Monitor System (TPMS)
- Black Roof Rails
- Heated Sideview Mirrors
- LED Daytime Running Lights
- Rear Foglight w/Auto Off

STANDARD SAFETY & SECURITY

- City Safety—Forward Collision Warning System with Full Auto Brake
- Roll Stability Control (RSC)
- Anti-Lock Brake System (ABS) w/Electronic Brake Assistance (EBA)
- Driver & Front Passenger Supplemental Restraint System-Three Step Air Bags
- Immobilizer, Encrypted Ignition Key
- Inflatable Side Curtains (IC)
- ISOFIX Baby/Child Seat Attachment System
- Safe Approach & Home Safe Lighting
- Seat Belts: 5, 3-point Inertia-Reel Belts w/Automatic Pre-tensioners
- Security Alarm
- Side-Impact Air Bags for Driver & Front Passenger
- Side-Impact Protection System (SIPS)
- Top Tether Child Seat Anchors
- Whiplash Protection Seating System (WHIPS)
- Rain Sensor
- Tunnel Detection

MAJOR OPTIONAL EQUIPMENT

- Metallic Paint
- Blind Spot Information System (BLIS) with

Cross-Traffic Alert & Front & Rear Park Assist

- Dual Outboard 2-stage Child Booster Seats w/Adaptive Seatbelts & Power Child Locks (rear doors)
- Accessory Prep Cable
- Heated Front Seats
- Active Dual Xenon Headlight w/Headlight Washers

OPTIONAL PACKAGES

- Premier Trim
 - Auto Dimming Interior Mirror
 - Leather Seating Surfaces
 - Laminate Panoramic Moonroof
 - Tinted Rear Seat & Cargo Windows
 - Silver Accent Side Décor
 - Silver Roof Rails
 - Metallic Paint
 - Personal Car Communicator (PCC) w/Keyless Drive
 - Adaptive Digital Display
- Climate Package
- Technology Package
 - Adaptive Cruise Control
 - Collision Warning w/Auto Brake
 - Distance Alert Control
 - Lane Departure Warning
 - Road Sign Information
 - Pedestrian & Cyclist Detection w/Full Auto Brake
 - Active Highbeams
 - Lane Departure Warning (some models)

VEHICLE LEVELS

- Premier
- Premier Plus
- Platinum

*See your local retailer for details.

† Dimensions shown may vary due to optional features and/or production variability.

‡ Volvo uses clearcoat paint for protection and beauty. All colors may not be available on all series.

For specific Canadian information, please contact the Volvo fleet manager in Toronto.

2015

XC70



XC70

Engine	2.0L T5	3.2L	3.0L T6 AWD
Engine Type Description	4-cylinder Turbo	In-Line 6-cylinder	In-Line 6-cylinder Turbo
Drivetrain	FWD	AWD	AWD
Number of Cylinders	TBD	6	6
CO ₂ /km	157 g	221 g	240 g
Horsepower	240 hp	240 hp	300 hp
Torque	258 lb-ft	236 lb-ft	295 lb-ft
Fuel	Reg. gas (87 octane)	Reg. gas (87 octane)	Reg. gas (87 octane)
Transmission	8-Speed Automatic	6-Speed Automatic	6-Speed Automatic

FUEL ECONOMY

MPG (Highway)	31 mpg	25 mpg	24 mpg
MPG (Combined)	27 mpg	21 mpg	20 mpg

SPECIFICATIONS

Dimensions†	(IN.)
Wheelbase	110.0
Length	190.5
Height	63.1
Width	73.3
Ground clearance (curb)	8.2
Headroom (front/rear)	38.8/38.6
Shoulder room (front/rear)	57.4/56.5
Hip room (front/rear)	54.81/55.1
Leg room (front/rear)	41.9/34.6

Capacities	
Cargo volume (cu. ft.)	72.1
Fuel capacity (gal.)	18.5

EXTERIOR‡

Ice White	Seashell (M)
Black Sapphire (M)	Black Stone
Twilight Bronze (M)	Flamenco Red (M)
Caspian Blue (M)	Crystal White (M)
Bright Silver (M)	M = Metallic

INTERIOR

Textile: Offblack
Leather: Soft Beige, Offblack, Espresso Brown

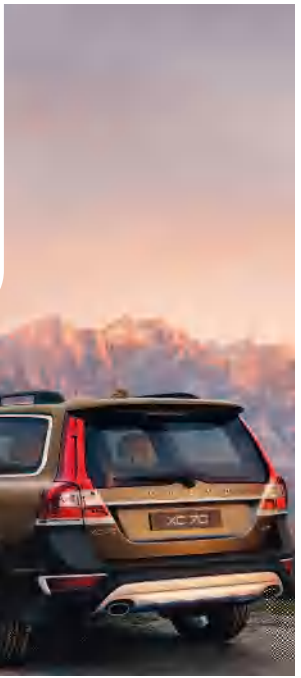

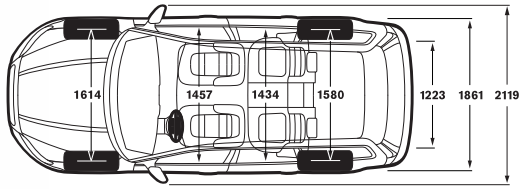
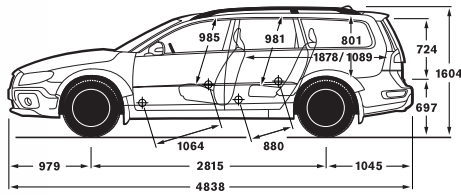

CANADA

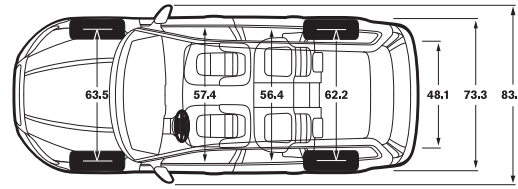
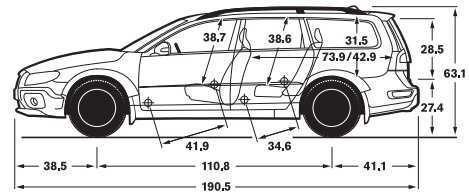

USA

KEY HIGHLIGHTS

- 2012 & 2013 Best Fleet Value in America Award Winner
- Complimentary Factory Scheduled Maintenance: The first three regularly scheduled maintenance services at 10,000, 20,000 & 30,000 mileage intervals* (not available in Canada)
- 4-year/50,000-mile limited warranty w/4-year/unlimited miles roadside assistance, standard*
- City Safety – Forward Collision Warning System with Full Auto Brake
- Pedestrian & Cyclist Detection w/Full Auto Brake available

MAJOR STANDARD EQUIPMENT

- 8-speed Geartronic™ Automatic Transmission
- 17" Valder Alloy Wheels
- 40/20/40 Split-Folding Rear Seat
- Driver Control Interface w/7" Hi Res Color Display w/Steering Wheel Controls
- High Performance Audio System
- HD Radio Technology
- USB/Aux/iPod® Connection
- SIRIUS Satellite Radio w/complimentary 6 month subscription
- Bluetooth® Technology w/Audio Streaming
- Cruise Control
- Electronic Climate Control w/Pollen Filter
- Power Heated Outer Mirrors
- Outside Temperature Gauge
- Power-Adjustable Driver Seat, 8-way w/3-position Memory & Lumbar Support
- Power Windows w/Driver & Passenger Auto Up/Down w/Anti-Trap Feature

- Tilt/Telescopic Leather Steering Wheel w/Illuminated Cruise & Audio Controls
- Tire Pressure Monitoring System (TPMS)
- Trip Computer
- LED Daytime Running Lights

STANDARD SAFETY & SECURITY

- City Safety – Forward Collision Warning System with Full Auto Brake
- 4-wheel Power-Assisted Disc w/Anti-Lock Brake System (ABS) & Electronic Brakeforce Distribution (EBD)
- Driver & Front Passenger Supplemental Restraint System - Three Step Air Bags
- Dynamic Stability & Traction Control (DSTC) Anti-skid System
- Immobilizer, Encrypted Ignition Key
- Inflatable Side Curtains (IC)
- ISOFIX Baby/Child Seat Attachment System
- Key Integrated Remote Control w/Central Power Door Locks
- Padded Head Restraints
- Side-Impact Air Bags for Driver & Front Passenger
- Side-Impact Protection System (SIPS)
- Approach & Home Safe Lighting
- Seat Belts: 3-point Inertia-Reel w/Automatic Pre-tensioners for all seating positions; Front Belts include Height Adjustment
- Security System w/Battery Backup Siren
- Top-Tether Child Seat Anchorage Capability
- Weight Sensor for Front Passenger Air Bag
- Whiplash Protection Seating System (WHIPS)
- Rain Sensor Windshield Wipers
- Tunnel Detection

MAJOR OPTIONAL EQUIPMENT

- 18" Zephyrus Alloy Wheels
- Blind Spot Information System (BLIS) w/Retractable Side Mirrors
- Dual-Integrated 2-stage Child Booster Seats
- Metallic Paint
- Active Dual Xenon Headlight
- Front & Rear Park Assist
- Heated Front Seats

OPTIONAL PACKAGES

- Climate Package
 - o Adaptive Cruise Control Start Stop w/ Queue Assist
 - o Collision Warning w/Auto Brake
 - o Distance Alert
 - o Driver Alert Control
 - o Lane Departure Warning
 - o Road Sign Information
 - o Active Highbeams
 - o Pedestrian & Cyclist Detection w/Full Auto Brake
- Technology Package

VEHICLE LEVELS

- Premier
- Premier Plus
- Platinum

*See your local retailer for details.

† Dimensions shown may vary due to optional features and/or production variability.

‡ Volvo uses clearcoat paint for protection and beauty. All colors may not be available on all series.

For specific Canadian information, please contact the Volvo fleet manager in Toronto.

2015

S80

S80

Engine	2.0L T5	3.0L T6 AWD
Engine Type Description	4-cylinder Turbocharged	6-cylinder Turbocharged
Drivetrain	FWD	AWD
Number of Cylinders	4	6
CO ₂ /km	TBD	240 g
Horsepower	240 hp	300 hp
Torque	258 lb-ft	295 lb-ft
Fuel	Reg. gas (87 octane)	Reg. gas (87 octane)
Transmission	8-Speed Automatic	6-Speed Automatic



FUEL ECONOMY

MPG (Highway)	37 mpg	28 mpg
MPG (Combined)	29 mpg	32 mpg

SPECIFICATIONS

Dimensions†	(IN.)
Wheelbase	111.6
Length	191.0
Height	58.8
Width	73.3
Headroom (front/rear)	37.8/38.3
Shoulder room (front/rear)	57.4/56.3
Hip room (front/rear)	54.8/54.7
Leg room (front/rear)	41.9/35.0

Capacities

Cargo capacities (cu. ft.)	14.9
Fuel capacity (gal.)	18.5

EXTERIOR‡

Ice White	Biarritz Blue (M)
Ember Black (M)	Magic Blue (M)
Twilight Bronze (M)	Electric Silver (M)
Black Stone	Saville Grey (M)
Crystal White (M)	M = Metallic

INTERIOR

Leather: Soft Beige or Off Black



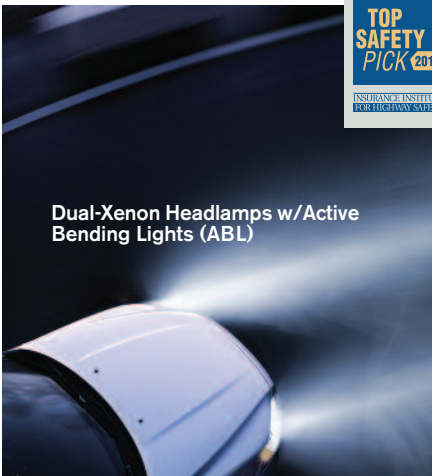

Dual-Xenon Headlamps w/Active Bending Lights (ABL)

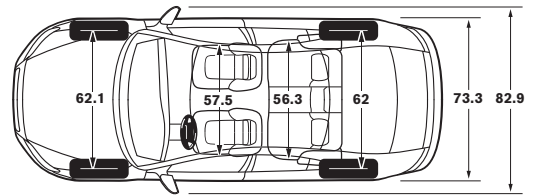
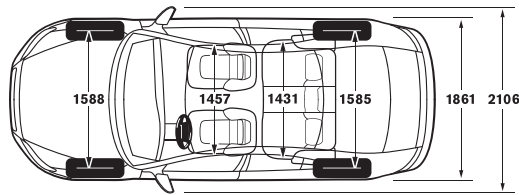
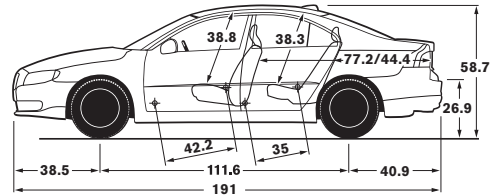
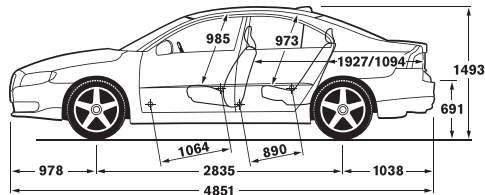

CANADA

USA

KEY HIGHLIGHTS

- Complimentary Factory Scheduled Maintenance: The first three regularly scheduled maintenance services at 10,000, 20,000 & 30,000 mileage intervals* (not available in Canada)
- 4-year/50,000-mile limited warranty w/4-year unlimited miles roadside assistance, standard*
- City Safety – Forward Collision Warning System with Full Auto Brake
- Pedestrian & Cyclist Detection w/Full Auto Brake available

MAJOR STANDARD EQUIPMENT

- Leather Seating
- 17" Rex Alloy Wheels (T5)
- Auto-Dimming Inside Rearview Mirror
- Bluetooth® Technology w/Audio Streaming
- Driver Control Interface w/7" Hi Res Color Display w/Steering Wheel Controls
- Cruise Control
- Dual Zone Electronic Climate Control (ECC) w/Pollen Filter
- High Performance Audio System with HD Radio, In-Dash Single CD Player, AM/FM Stereo, USB/iPod® Connection
- SIRIUS Satellite Radio w/complimentary 6 month subscription
- Intelligent Driver Information System (IDIS)
- Outside Temperature Gauge
- Power Seats, Driver & Passenger w/Memory Function for Driver's Seat
- Tire Pressure Monitoring System (TPMS)
- Start & Stop Technology (T5)
- LED Daytime Running Lights
- Adaptive Digital Display

STANDARD SAFETY & SECURITY

- City Safety – Forward Collision Warning System with Full Auto Brake
- Alarm
- Anti-Lock Brake System (ABS)
- Dynamic Stability & Traction Control (DSTC) Anti-skid System
- Immobilizer, Encrypted Ignition Key
- Inflatable Side Curtains (IC)
- ISOFIX Baby/Child Seat Attachment System
- Key Integrated Remote Control w/Central Power Door Locks
- Occupancy Weight Sensor
- Side-Impact Air Bags for Driver & Front Passenger
- Side-Impact Protection System (SIPS)
- Whiplash Protection Seating System (WHIPS)
- Driver & Front Passenger Supplemental Restraint System - Three Step Air Bags
- Personal Car Communication w/Keyless Drive
- Rain Sensor Windshield Wipers
- Tunnel Detection

MAJOR OPTIONAL EQUIPMENT

- Blind Spot Information System (BLIS)
- Metallic Paint
- Power Glass Moonroof, T5 (Std. T6)
- Dual-Xenon Headlamps w/Active Bending Lights (ABL)
- Heated Front Seats
- Accessory Prep Cable
- 18" Magni Alloy Wheels

OPTIONAL PACKAGES

- Climate Package
 - o Heated Windshield
 - o Heated Steering Wheel
 - o Heated Front & Rear Seats
 - o Heated Windshield Washer Nozzles
 - o Interior Air Quality Sensor (IAQS)
- Inscription Package (T6)
- Technology Package
 - o Adaptive Cruise Control Start Stop w/ Queue Assist
 - o Collision Warning w/Full Auto Brake
 - o Distance Alert
 - o Driver Alert Control
 - o Lane Departure Warning
 - o Road Sign Information
 - o Active Highbeams
 - o Pedestrian & Cyclist Detection w/Full Auto Brake

VEHICLE LEVELS

- Premier Plus
- Platinum



*See your local retailer for details.

† Dimensions shown may vary due to optional features and/or production variability.

‡ Volvo uses clearcoat paint for protection and beauty. All colors may not be available on all series.

For specific Canadian information, please contact the Volvo fleet manager in Toronto.

2014

XC90



XC90

Engine	3.2L	3.2L R-Design
Engine Type Description	In-Line 6-cylinder	In-Line 6-cylinder
Drivetrain	FWD	FWD
Number of Cylinders	6	6
CO ₂ /km	240 g	240 g
Horsepower	240 hp	240 hp
Torque	236 lb-ft	236 lb-ft
Fuel	Reg. gas (87 octane)	Reg. gas (87 octane)

FUEL ECONOMY

MPG (City) 6-speed Geartronic™ Automatic Transmission	16 mpg	16 mpg
MPG (Highway) 6-speed Geartronic™ Automatic Transmission	23 mpg	23 mpg



SPECIFICATIONS

Dimensions [†]	(IN.)
Wheelbase	112.6
Length	189.3
Height	70.2
Width	76.2
Ground clearance (curb)	8.6
Headroom (front/rear)	38.4/39.7
Shoulder room (front/rear)	58.3/57.4
Hip room (front/rear)	55.4/53.6
Leg room (front/rear)	41.0/36.4

Capacities	
Cargo capacities (cu. ft.)	85.1
Fuel capacity (gal.)	21.1

EXTERIOR[‡]

Ice White	Flamenco Red (M)
Ember Black (M)	Black Stone
Electric Silver (M)	Saville Grey (M)
Passion Red (R-Design)	Caspian Blue (M)
Twilight Bronze (M)	Crystal White (M)
Black Sapphire (M) (R-Design)	

M = Metallic

INTERIOR

Leather: Soft Beige or Offblack
 R-Design Leather: Calcite Smooth or Soft-Black Smooth

Volvo Accessories: The Rear Seat Entertainment System is a popular accessory for the XC90. See the Volvo Fleet Specifications and Pricing Guidelines for details.



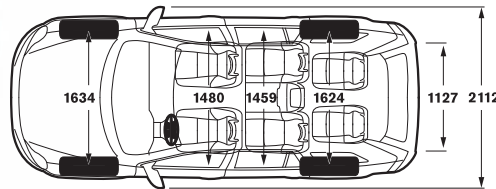
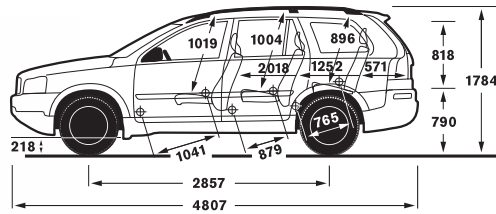

CANADA

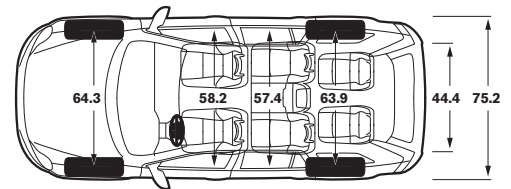
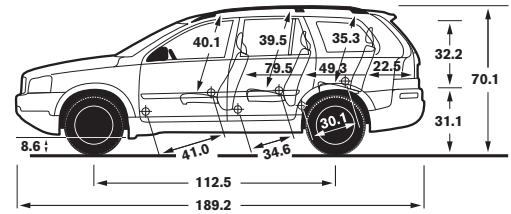

USA

KEY HIGHLIGHTS

- Fuel Economy: MPG 16 City/23 Highway
- **Complimentary Factory Scheduled Maintenance: The first three regularly scheduled maintenance services at 10,000, 20,000 & 30,000 mileage intervals*** (not available in Canada)
- 4-year/50,000-mile limited warranty w/4-year/unlimited miles roadside assistance, standard*

MAJOR STANDARD EQUIPMENT

- Leather Seating Surfaces
- 6-speed Geartronic™ Automatic Transmission
- 18" Thalia Alloy Wheels
- Power Glass Moonroof
- Third Row Seats w/Leather Seating Surface
- 7-Passenger Seating
- 70/30 Dual-Split Tailgate w/Leather Strip
- Cruise Control
- Driver Information Display
- Dual-Zone Electronic Climate Control (ECC) w/Pollen Filter
- Flat-Folding 40/20/40 Split Second-Row Seat
- Front Stainless Steel Skid Plate
- High Performance Audio w/4x40-watt Amplifier, 8 Speakers, In-Dash Single CD
- Auxiliary Input & USB Connection
- HD Radio Technology
- SIRIUS Satellite Radio w/complimentary 6 month subscription
- Outside Temperature Gauge
- Power-Adjustable Driver Seat, 8-way w/3-position Memory & Lumbar Support
- Power Adjusted Passenger Seat
- Power-Adjustable Heated Exterior Rearview Mirrors w/Memory Function

- Power Windows w/Driver & Passenger Auto Up/Down w/Anti-Trap Feature
- Bluetooth® Technology
- Rear-Door Intermittent Wiper (w/automatic function when transmission in reverse & front wipers on)
- Air Conditioning for Third Row Seat w/separate control
- Tilt/Telescopic Steering Wheel w/Illuminated Cruise & Audio Controls
- Tire Pressure Monitoring System (TPMS)
- Trip Computer
- Silver Roof Rails

STANDARD SAFETY & SECURITY

- Rear Park Assist
- 4-channel Anti-Lock Brake System (ABS)
- Alarm
- Driver & Front Passenger Supplemental Restraint System – Dual-Threshold Air Bags
- Dynamic Stability & Traction Control (DSTC)
- Immobilizer Rolling Code Theft Deterrent Keys
- Inflatable Side Curtains (IC)
- ISOFIX Baby/Child Seat Attachment System
- Padded Head Restraints
- Pedestrian Protection
- Pyrotechnic Seatbelt Pre-tensioners, all seating positions
- Rain Sensor Windshield Wipers
- Rear Door Child Safety Locks
- Roll Stability Control (RSC)
- Remote Keyless Entry/Central Locking System
- Security System w/Siren, Battery Backup
- Side-Impact Protection System (SIPS) including Airbags

- Weight Sensor for Front Passenger Air Bag
- Whiplash Protection Seating System (WHIPS)
- Rain Sensor Windshield Wipers
- Headlight Washers
- Front LED Daytime Running Lights
- Rear LED Brake Lights

MAJOR OPTIONAL EQUIPMENT

- Blind Spot Information System (BLIS) w/Retractable Side Mirrors
- Metallic Paint
- Volvo Dual-Screen Rear Seat Entertainment System
- Wood Steering Wheel
- All Wheel Drive

OPTIONAL PACKAGES

- Climate Package
 - Heated Front Seats
 - Interior Air Quality System (IAQS)

VEHICLE LEVELS

- Premier Plus
- Platinum

*See your local retailer for details.

† Dimensions shown may vary due to optional features and/or production variability.

‡ Volvo uses clearcoat paint for protection and beauty. All colors may not be available on all series.

For specific Canadian information, please contact the Volvo fleet manager in Toronto.

- Extra High Strength Steel
- Very High Strength Steel
- High Strength Steel
- Mild Steel / Forming Grades
- Aluminium
- Magnesium

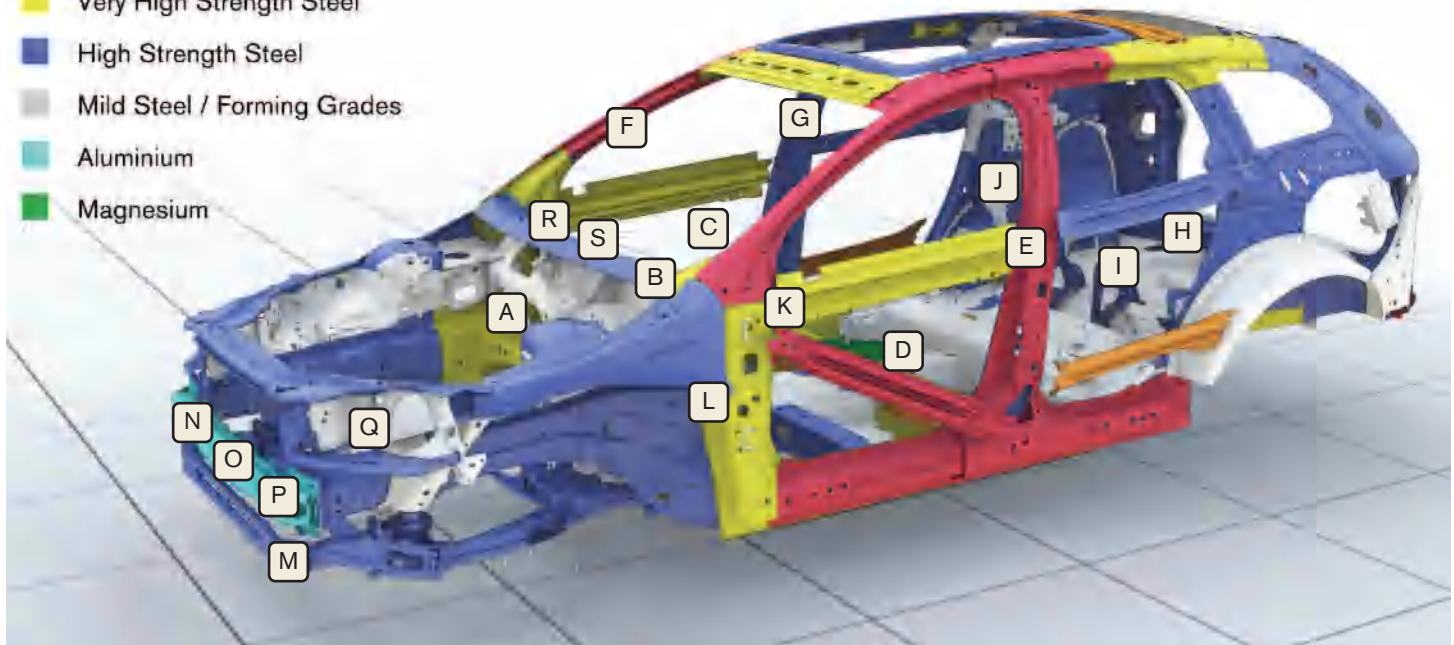

A. UNIQUE ENGINE INSTALLATION

Our vehicles go through a series of computer simulated frontal crash tests without the engine installed. The engines are then designed to fit within the empty space that remains after the simulation crash test. In a real collision the engine may be shunted rearward before contacting the bulkhead.

B. SAFETY CAGE

The robust safety cage is designed as an interactive web of steel profiles that surrounds the occupants. The safety cage consists of four different grades of steel to help provide optimum protection and low weight.

C. ADAPTIVE AIRBAGS

The driver and front passenger airbags assist in protecting the head, face and chest in a frontal collision. They monitor the force of the impact and adapt inflation to the severity of the collision, with full or reduced pressure, depending on the impact force. The driver's airbag also interacts with the steering column, which collapses in a controlled way so that the airbag can help provide optimum protection. If the collision force is not sufficient to trigger the airbag, only the seat belt pre-tensioner is activated. The passenger airbag is automatically connected or disconnected by sensors that monitor the weight of the person in the front passenger's seat.

D. SIPS (SIDE-IMPACT PROTECTION SYSTEM)

SIPS distributes crash forces in a side impact across a larger part of the car's body in order to help minimize the strain on the occupants. Extra reinforcement in the doors, door pillars and dashboard, among other areas, enhances side impact protection still further. The IC (Inflatable Curtain) for all the car's outboard occupants and the front side airbags help reduce the risk of injury to the head, chest and hips. The rear doors feature energy-absorbing blocks that help distribute incoming collision forces in a side impact.

E. PROTECTION IN COLLISIONS INVOLVING LARGER VEHICLES

Sturdy upper front side members improve protection in a frontal collision with a larger vehicle. The door pillars and door sides feature extra reinforcement to help withstand impacts if the car collides with a tall vehicle such as an SUV.

F. IC (INFLATABLE CURTAIN)

IC (Inflatable Curtain) offers occupant protection irrespective of whether you are in the front or rear seat. It inflates in certain side impacts to help protect the heads of all outboard occupants. For added safety during multiple collision sequences or collisions of longer duration, it stays inflated for up to three seconds.

G. SEAT BELTS WITH PRE-TENSIONERS AND SEAT BELT REMINDERS

All seats have head restraints and 3-point seat belts. In a crash, the front and rear outboard seat belts are tensioned across according to the size of the occupant, then slacken slightly so that the occupants are restrained by the airbags in a more controlled manner.

H. LOAD SAFETY

Loads should be secured using the eyelets in the floor of the trunk

I. CHILD SAFETY

Volvo has designed this vehicle with the safety of children in mind. Smaller children up to the age of three, however, travel most safely in a rearward-facing child seat. The integrated booster cushions help ensure that the seat belt is at the right height for somewhat older children. The rear outboard seats are equipped with ISOFIX/LATCH anchors.

J. WHIPS (WHIPLASH PROTECTION SYSTEM)

WHIPS helps reduce injury by cradling the spine and neck in a controlled way if the car is hit from behind at low speeds. It is built into the front seats and activated by a sufficiently severe impact.

K. ENERGY-ABSORBING INTERIOR

All of the panels and door sides are padded with energy-absorbing materials to help reduce the risk of injury to the occupants. The ignition lock is located on the dashboard, which helps reduce the risk of knee injuries to the driver.

L. PROTECTED ZONES

Volvo's patented frontal structures with various zones are designed to distribute incoming collision forces. An extra-rigid cross member under the dashboard helps reduce intrusion into the cabin and helps protect feet and legs. The pedals are also designed to reduce the risk of foot injuries.

M. ENERGY ABSORBING STRUCTURE

The front and rear structures dissipate and distribute incoming collision forces to reduce the effects on the car's occupants. The bumpers are reinforced with a beam made of boron steel to help withstand low-speed knocks without deforming the body structure.

N. PEDESTRIAN PROTECTION

The smooth front and energy-absorbing structure with its soft plastic beam ahead of the bumper can help reduce the risk of injury to unprotected road users. The hood and front fenders help absorb crash energy for anyone colliding with the car.



Pedestrian Detection

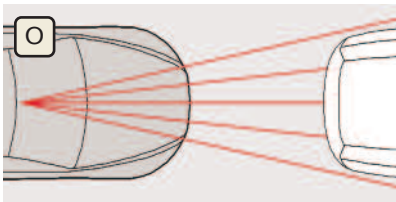

City Safety

O. CITY SAFETY

City Safety is a Volvo Car Corporation developed low-speed auto brake technology that helps avoid or reduce the consequences of an accident.

P. PEDESTRIAN DETECTION

Using a digital camera and radar, Collision Warning with Full Autobrake constantly scans the road ahead. Shapes identified as people at risk will trigger a warning. More importantly, the system will employ full brake force to stop your vehicle – if you don't.

Q. ACTIVE HIGH BEAM

High beam headlights automatically switch to low beam when opposite traffic is detected entering the high beam zone. Available only in combination with Technology Package.

R. ROAD SIGN INFORMATION (RSI)

When traffic speed signs appear on the road, the system displays them to the driver. RSI utilizes the Forward Looking Camera (FLC) and navigation. Requires Technology Package.

S. TUNNEL DETECTION

Automatically turns on the headlights when the vehicle enters a tunnel and returns lights to the previous setting when the vehicle exits a tunnel. This sensor is part of the Rain Sensor, so there is no sign of it on the exterior. Note that the light switch now has a new position marked "A."

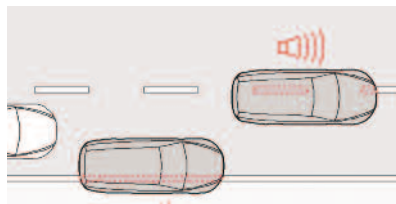

Lane Departure Warning

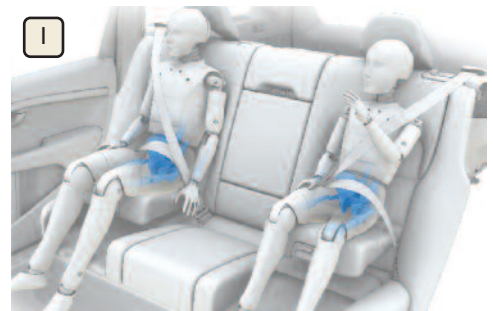

VOLVO SAFETY

ACCESSORIES Port-Installed

Volvo is pleased to offer this program to our Commercial Fleet customers. The Port-Installed Accessories Program* lets you add a select group of Volvo's most popular accessories to vehicles that have already landed at our ports. These accessories are professionally installed by Volvo technicians and are covered by Volvo's 4-year, 50,000 mile new car limited warranty. Better yet, the cost of the accessory is included on the invoiced price of the car. This allows you to add the cost into the lease payments. It's as if these accessories were ordered and installed right at the factory.



Running Board
XC60
XC90



Front Blind View Camera
V60 XC60
XC70 S60
S80



Rear Seat Entertainment
S60 XC90
XC60 XC70



Integrated Navigation System
XC60 XC70
S60 S80



Trailer Hitch (Draw Bar not included)
XC60 (Non R-Design)
XC70
XC90



Remote Start
V60 S60
S80 XC60
XC70



Sport Appearance/Exterior Styling
V60 S60
XC60

*Program may vary in Canada.

ENVIRONMENT

Caring For The Environment

TO CARE

Concern for the environment is part of your driving experience, no matter which Volvo you choose. In every case, you get a fuel efficient car that meets very strict emission standards. It is quite simply more enjoyable to drive a car that takes the environment into consideration.

CLEAN INSIDE

A cabin air filter ensures that dust, exhaust particles and pollen do not enter the cabin through the ventilation system. Moreover, interior components such as the ignition key, center console and parking brake handle button are tested with regard to contact allergies.

CLEAN OUTSIDE

High efficiency engines reduce fuel consumption, thereby also reducing emissions of carbon dioxide, a greenhouse gas. Advanced engine emission control technology eliminates 95-98% of carbon monoxide, hydrocarbons and nitrogen oxides from the exhaust gases. The catalytic converter is positioned right beside the engine so it provides full exhaust conversion more quickly after a cold start. The engines already meet very stringent ULEV II emissions standards. PremAir coating on the radiators installed on our 3.2L PZEV engines can convert up to 75% of the

ground-level ozone in the radiator cooling air into oxygen, another step towards a cleaner environment.

CLEAN ALL ITS LIFE

In every Volvo, environmental care is built in from the initial design and engineering stages. Our cars are built in one of the automotive world's cleanest factories, and 85% of every Volvo can be recycled. But we wanted to give you additional information about the environmental impact of your Volvo during its entire life cycle. That's why all Volvo models come with EPI (Environmental Product Information). It gives the car buyer an overview of the car's environmental impact throughout its lifetime, and thus makes it easier to compare the eco performance of Volvo's various models and engine alternatives. More information can be viewed at www.volvocars.com/experience/environment.htm

CONTRIBUTING TO SUSTAINABLE DEVELOPMENT

Volvo Cars aims to be a leader in corporate

citizenship, ensuring a balance between the needs of the company, its customers, society, and future generations. Environmental responsibility is an important part of this effort, and so too is a far reaching undertaking to safeguard society's interests in Volvo's role as an employer and as a builder of that society, independently and together with other companies, authorities and organizations. Our annual "Corporate Citizenship" report is available at www.volvocars.com/citizenship.

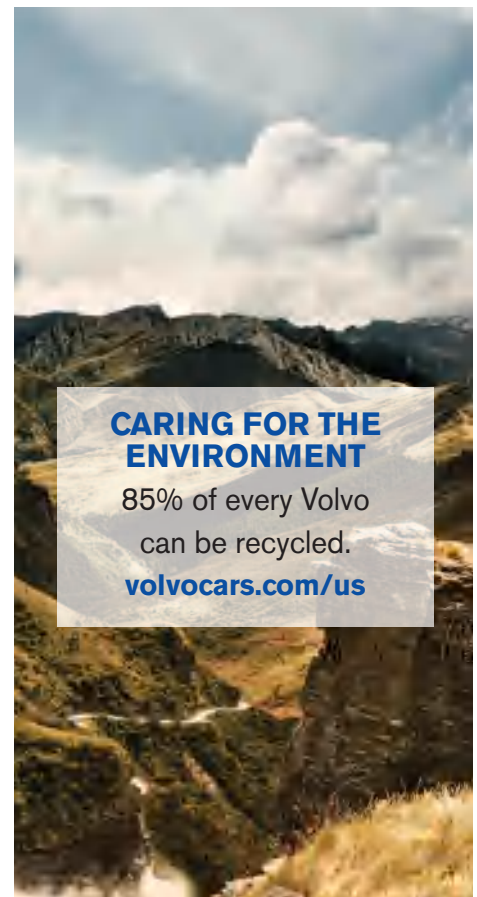

For your Volvo Premium Fleet Experience, call 1 (877) 283-5338 or (416) 268-0235

CONTACTS Fleet Sales Department

Volvo Cars of North America, LLC

Fleet Sales Department

1 Volvo Drive, P.O. Box 914
Rockleigh, NJ 07647
1 (877) 283-5338
Fax: (201) 784-4599

North Holbrook

Manager, Commercial Sales
(949) 981-8969
north.holbrook@volvocars.com

Gerard Merritts

National Fleet Manager
(201) 637-6079
gerry.merritts@volvocars.com

Bill Kugel

Commercial Fleet Market Manager
(201) 218-6877
bill.kugel@volvocars.com

Emily Borsh

Commercial Fleet Specialist
(201) 767-4818
emily.borsh@volvocars.com

Volvo Canada

Emanuel Lichtinshtein

National Fleet Manager
(416) 268-0235
emanuel.lichtinshtein@volvocars.com

Volvo Fleet "A Premium Fleet Experience"

This communication contains information from Volvo Cars of North America, LLC that may be confidential. Except for personal use by the intended recipient, or as expressly authorized by the sender, any person who receives this information is prohibited from disclosing, copying, distributing, and/or using it. If you have received this communication in error, please immediately delete it and all copies, and promptly notify the sender. Nothing in this communication is intended to operate as an electronic signature under applicable law.



FSM Factory Scheduled Maintenance

Volvo is committed to a premium fleet experience for its customers along with driving down your lifecycle costs. To further enhance your fleet experience, all 2015 model year Volvo vehicles sold new to a fleet customer and registered in the U.S. by an authorized Volvo Retailer will include Complimentary Factory Scheduled Maintenance. This program provides scheduled maintenance coverage for the first three services or 30,000 miles, is designed to complement your Volvo warranty, and will help to ensure trouble-free operation of your Volvo vehicle. Coverage includes factory recommended maintenance including oil and filter changes, checks and adjustments as listed in the Warranty and Maintenance Records Information booklet, for the first three maintenance services at intervals of 10,000, 20,000 and 30,000 miles. See your Volvo Retailer for details.

FSM not available in Canada.

Special Vehicle Pricing For All Employees of Our Fleet Customers



At Volvo we appreciate your interest in our vehicles and would like to offer your company a special opportunity to participate in the A-PLAN BY VOLVO Corporate Partner program. By participating, your employees are eligible to purchase or lease new Volvo vehicles at special discounted pricing. How discounted? This non-negotiated purchase price is the same price that employees of Volvo Cars of North America pay for their new vehicles!

All you have to do is register your company at www.aplanbyvolvo.com/companyregistration, and your employees will have immediate access to purchase or lease a new Volvo at a great price. There is no cost to your company to participate and there is no additional program administration required.

When you purchase a new Volvo under the A-PLAN BY VOLVO program, the price is set and there is no negotiation with the dealer. All new vehicle invoices have the A-PLAN BY VOLVO price clearly printed on the new vehicle invoice. Additionally, customers can find A-PLAN pricing on the www.aplanbyvolvo.com website, so there is no mystery as to what you pay for the car.

In addition to attractive A-PLAN BY VOLVO pricing, you are eligible for any applicable retail incentives at the time of purchase. Your local Volvo retailer can help you determine which incentives are applicable.





Mixed Sources

Product group from well-managed forests, controlled sources and recycled wood or fiber

Cert no. SW-COC-002285
www.fsc.org
© 1996 Forest Stewardship Council

WWW.VOLVOCARS.COM/US



Note: Specifications, features and equipment shown in this catalog are based upon the latest information at the time of publication. Volvo Cars of North America, LLC reserves the right to make changes at any time, without notice, to colors, specifications, accessories, materials and models. For additional information, please contact the Fleet Sales Department 1 (877) 283-5338.
©2014 Volvo Cars of North America, LLC. Printed in USA.