

FOREWORD

Thank you for purchasing an INFINITI automobile. This user's manual is for the navigation system only.

Please read this manual carefully to ensure safe operation of the navigation system. This manual contains operating instructions for the INFINITI Navigation System offered in your INFINITI vehicle

- Please read your vehicle's owner's manual first.
- Do not remove this manual from the vehicle when selling this vehicle. The next user of this navigation system may need the manual.
- Because of possible specification changes, sections of this manual may not apply to your vehicle.
- All information, specifications and illustrations in this manual are those in effect at the time of printing. INFINITI reserves the right to change specifications or design at any time without notice.

Table of Contents

Introduction	1
How does the Infiniti navigation system work?	2
What features are available on the Infiniti navigation system?	3
How do I operate the Infiniti navigation system?	4
How do I program a destination?	5
How do I use the Point of Interest (POI) feature?	6
How do I use the address book feature?	7
How do I use the avoid area feature?	8
How do I use the automatic re-routing feature?	9
How do I use the voice guidance feature?	10
How do I adjust the display?	11
Information on map data discs	12
Troubleshooting guide	13
Index	14

1 Introduction

How to use this manual	1-2
For safe operation	1-2
Reference symbols	1-2

Safety note	1-2
Laser product	1-3

HOW TO USE THIS MANUAL

This manual uses special words and icons, organized by function. Please refer to the following items and familiarize yourself with these symbols.

FOR SAFE OPERATION

WARNING

This is used to indicate the presence of a hazard that could cause death or serious personal injury. To avoid or reduce the risk, the procedures must be followed precisely.

CAUTION

This is used to indicate the presence of a hazard that could cause minor or moderate personal injury or damage to your vehicle. To avoid or reduce the risk, the procedures must be followed carefully.

NOTE:

This indicates an item to help you understand the maximum performance of your vehicle. If ignored, it may lead to a malfunction or poor performance.

REFERENCE SYMBOLS

INFO:

This indicates information necessary for efficient use of your vehicle or accessories.

 button

This is a button on the control panel.

 key

This is a select key on the screen. By selecting this key you can proceed to the next function.

SAFETY NOTE

This system is primarily designed to help you reach your destination, and also performs other functions as outlined in this manual. However, you, the driver, must use the system safely and properly. Information concerning road conditions, traffic signs and the availability of services may not always be up-to-date. **The system is not a substitute for safe, proper, and legal driving.**

Before using the navigation system, please read the following safety information. Always use the system as outlined in this manual.

WARNING

- **When the driver operates the navigation system or uses the joystick (screen function), first park the vehicle in a safe place and set the parking brake. Using the system while driving can distract the driver and may result in a serious accident. Destinations cannot be set while the vehicle is in motion.**
- **Do not rely on voice guidance alone. Always be sure that all driving maneuvers may be made legally and safely to avoid an accident.**

- **Do not disassemble or modify this system. If you do, it may result in accidents, fire, or electrical shock.**
- **Do not use this system if you notice any malfunction such as a frozen screen or lack of sound. Continued use of the system may result in accident, fire, or electrical shock.**
- **If you notice any foreign object in the system hardware or spilled liquid, or notice smoke or a smell coming from it, stop using the system immediately and contact your nearest INFINITI dealer. Ignoring such conditions may lead to accidents, fire, or electrical shock.**

NOTE:

Some states/provinces may have laws limiting the use of video screens while driving. Use this system only where legal.

LASER PRODUCT

This navigation system is certified as a Class I laser product.

The navigation system complies with DHHS Laser-Radiation Standards, 21 CFR Chapter 1, subchapter J.

 WARNING

- **Do not disassemble or modify this system. There are no user serviceable parts in this navigation system.**
- **If maintenance, adjustments and operations other than those specified in this manual are attempted, injury due to laser radiation and exposure could occur.**

MEMO

2 How does the Infiniti navigation system work?

What is a navigation system?	2-2	Receiving signals from GPS satellites.	2-3
About the navigation system	2-2	Display of GPS information	2-3
What is GPS (Global Positioning System)?	2-2	Detailed map coverage areas (MCA) for the	
Accuracy of positioning	2-2	navigation system	2-3
Positioning adjustment	2-3	When a gray road is displayed on the map	2-4

WHAT IS A NAVIGATION SYSTEM?

ABOUT THE NAVIGATION SYSTEM

This navigation system combines the data obtained from the vehicle (by gyro sensor) and from GPS (Global Positioning System) satellites to calculate the current location of the vehicle. This position is then displayed on the screen, allowing route guidance to a destination.

WHAT IS GPS (Global Positioning System)?

GPS is a system developed and operated by the U.S. Government, covering the entire planet. This navigation system receives three or more different radio signals from NAVSTAR (GPS satellites), orbiting the earth 13,049 miles (21,000 km) above ground. The data from different sets of signals are trigonometrically calculated to obtain the position of the vehicle.

INFO:

The tracking center in the U.S. controls signals transmitted from GPS satellites. This control sometimes results in reduced accuracy or no signal received at all, in accordance with government requirements. Consequently, areas such as military bases may not accurately appear on the navigation screen.



ACCURACY OF POSITIONING

The color of the GPS Indicator  on the upper left corner of the screen indicates positioning as follows:

- Green: positioning is possible and accurate
- Yellow: positioning is possible but accuracy is minimal
- Gray: positioning is not possible

INFO:

For approximately 3 or 4 minutes after system startup, the GPS indicator  remains gray, even if accurate positioning is possible.

POSITIONING ADJUSTMENT

When the system judges that the vehicle position information is not accurate based on vehicle speed and gyro sensor data calculations, the system will adjust the vehicle position information using GPS signals.

RECEIVING SIGNALS FROM GPS SATELLITES

Sometimes, satellite reception is weak. The following are places where signals tend to be weak:

- Inside tunnels and parking lots in buildings
- Areas with numerous tall buildings
- Under multi-layered highways
- In a dense forest
- Near military bases and certain government facilities

Vehicles in these areas may not receive GPS signals (Indicator color: gray).

INFO:

The antenna for GPS is located on the instrument panel inside the vehicle. **Do not place any objects, especially mobile phones or transceivers, on the instrument panel.** Be-

cause the strength of the GPS signals are approximately one billionth of that of TV waves; phones and transceivers will decrease the strength or may totally disrupt the signals.

DISPLAY OF GPS INFORMATION

This system displays GPS information.

Please refer to “GPS information display” on page 11-17.

NOTE:

Directional guidance provided by the navigation system does not take carpool lane driving into consideration, especially when carpool lanes are separated from other road lanes.

DETAILED MAP COVERAGE AREAS (MCA) FOR THE NAVIGATION SYSTEM

This system is designed to help you reach your destination, and also performs other functions as outlined in this manual. However, you, the driver, must use the system safely and properly. Information concerning road conditions, traffic signs and the availability of services may not always be up-to-date. The system is not a substitute for safe, proper, and legal driving.

Map data covers select metropolitan areas in the United States.

Map data is available on map DVD-ROM. For information about map DVD-ROMs, contact an INFINITI dealer or call the INFINITI Navigation System help desk at 1-800-662-6200 for U.S. and at 1-800-777-0325 for CANADA..

Map data includes 2 types of areas: “Detailed coverage areas” providing all detailed road data and other areas showing “Main roads only”.

NOTE:

Detailed map data is not available in many areas and is generally limited to select major metropolitan areas.

For information on which metropolitan areas are in detailed coverage areas, please refer to the INFINITI Navigation System Software Booklet

(included). When you purchase an updated map DVD-ROM, a new software booklet will be provided.

WHEN A GRAY ROAD IS DISPLAYED ON THE MAP

- Route calculation may not be possible when a destination or the current vehicle location is near a gray road.
- When setting a destination, the road near the cross cursor blinks. For gray roads, however, the road may not blink.
- When you are driving on a gray road after the vehicle has deviated from the suggested route during route guidance, automatic re-routing may not start immediately.
- Route guidance (enlarged view and voice guidance) may not be done at the intersection where the road your vehicle is driving on and a gray road intersect.
- POI information and street names near gray roads are not contained in the map data.

3 What features are available on the Infiniti navigation system?

Route guidance	3-2
Point of interest (POI) directory	3-2
Address book	3-2
Avoid area	3-3
Automatic re-route	3-3

Detour	3-3
Birdview™	3-4
Voice guidance	3-4
Short menus	3-4

ROUTE GUIDANCE

The main feature of the INFINITI Navigation System is Visual and Audio Route Guidance in selected detailed map coverage areas. Utilizing a network of GPS (Global Positioning System) satellites, the INFINITI Navigation System tracks your location on the map and directs you where you want to go.

Once you program a destination covered by a detailed map, The INFINITI Navigation System will determine a route from your current location to your destination. The moving map display and turn-by-turn voice commands help the driver determine upcoming turns.

This feature can be especially helpful in finding unfamiliar locations or businesses. The system may be unable to set a destination and/or calculate distance when a destination is outside a detailed map coverage area. Additionally, audio route guidance may not be available if the destination is outside a detailed map coverage area. For more information on how to program a destination, please refer to section 5.

POINT OF INTEREST (POI) DIRECTORY

The INFINITI Navigation System offers an extensive Point of Interest (POI) directory in detailed map coverage areas for your convenience. This directory includes a wide variety of destinations ranging from gas stations, ATMs, and restaurants to casinos, ski resorts, shopping centers and businesses. By accessing the Point of Interest directory, you can search for addresses and phone numbers for a destination, and with a press of a button, the INFINITI Navigation System will calculate a route to the destination.

The Point of Interest directory offers many uses. For example, the directory can be sorted by the various types of restaurants near your current location. If you need an ATM or gas station, the INFINITI Navigation System can point you to the closest one or the closest one of your favorite brand.

For more information on how to use the Point of Interest directory, please refer to section 6.

ADDRESS BOOK

Using the Address Book feature, you will have the ability to store up to 50 locations in detailed map coverage areas into a personal directory. This is especially useful for frequently visited locations, such as your clients, relatives, or friends. The Address Book feature will provide you with easy access to frequently visited locations when setting them as your destination.

For more information on how to use your Address Book, please refer to section 7.

AVOID AREA

By using the Avoid Area feature, you can identify areas or freeways that you would like the INFINITI Navigation System to avoid when plotting routes. For example, if you know of a freeway or area that is always congested with traffic, you can program the INFINITI Navigation System to plot routes that go around that particular freeway or area.

For more information on the Avoid Area feature, please refer to section 8.

AUTOMATIC RE-ROUTE

If you miss a turn while using the Route Guidance feature, the INFINITI Navigation System will automatically recalculate a new route to your destination.

For more information on the Automatic Re-route feature, please refer to section 9.

DETOUR

If you hear about a traffic accident on the radio that is 4 miles (6 km) ahead of you and traffic is backing up fast, you can use the Detour function to calculate an alternative route that will help you avoid the gridlock caused by the traffic accident. The INFINITI Navigation System has the ability to find an alternative route using secondary roads that will return you to primary roads after a specified number of miles.

For more information on the Detour feature, please refer to section 9.

Birdview™

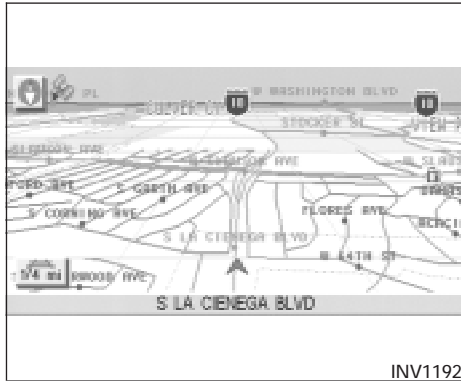

The INFINITI Navigation System gives you a choice of two map viewing styles, a normal 2-dimensional Plan View map and the 3-dimensional Birdview™ map. The 3-D Birdview™ map depicts a geographic area as seen from an elevated perspective, so you will get a better feel for the route ahead.

For more information on the Birdview™ feature, please refer to section 11.

VOICE GUIDANCE

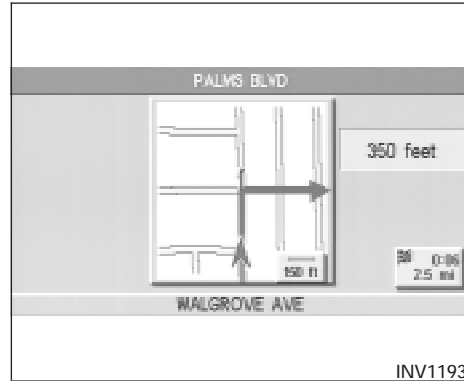

Route guidance is executed using voice and screen instruction. When the vehicle approaches an intersection where you need to turn, the voice guidance tells you the direction to take.

The system also has the following useful features:

- Enlarged display of intersections.
- Automatic rerouting when a vehicle is off the course (when map is displayed).

For more information on the Voice Guidance feature, please refer to section 10.

SHORT MENU

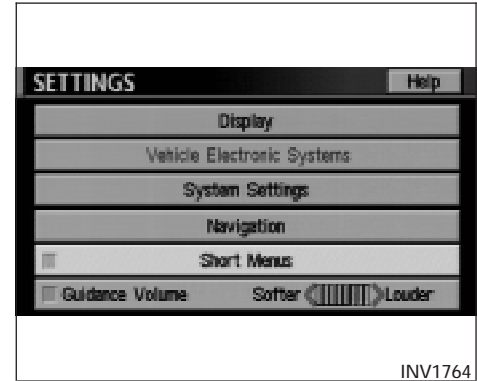

To make the INFINITI Navigation System easier to use, there is a short menu function in which the most commonly used items are listed. When the indicator is illuminated, the short menu (Easy Mode) are displayed. When the indicator is turned off, the default navigation systems menu (Expert Mode) are displayed.

INFO:

- [Easy Mode] is the default setting on the initial screen at the delivery of your new vehicle.
- Term [Expert Mode] is used in this manual when the **Short Menu** key indicator is turned off. When the amber indicator is high-

3-4 What features are available on the Infiniti navigation system?

lighted, the system is set to [Easy Mode].

- When the **SETTING** , **DEST** or **ROUTE** button is pressed in the [Easy Mode] screen, the **Help** key is displayed.

For more information on the Short Menu feature, please refer to section 4.

MEMO

3-6 What features are available on the Infiniti navigation system?

4 How do I operate the Infiniti navigation system?

Control panel button functions	4-2	Setting up the start-up screen	4-12
Names of the components.....	4-3	Confirmation of destination or waypoint	4-12
How to use the joystick and the enter button.....	4-3	Clearing the memory.....	4-15
How to use the PREV button	4-4	Setting the average speed.....	4-17
How to use the SETTING button.....	4-4	About route guidance	4-18
How to use the DEST button.....	4-7	Notes on route guidance	4-18
How to use the ROUTE button	4-8	About the display error.....	4-20
How to eject/insert the disc.....	4-10		

CONTROL PANEL BUTTON FUNCTIONS

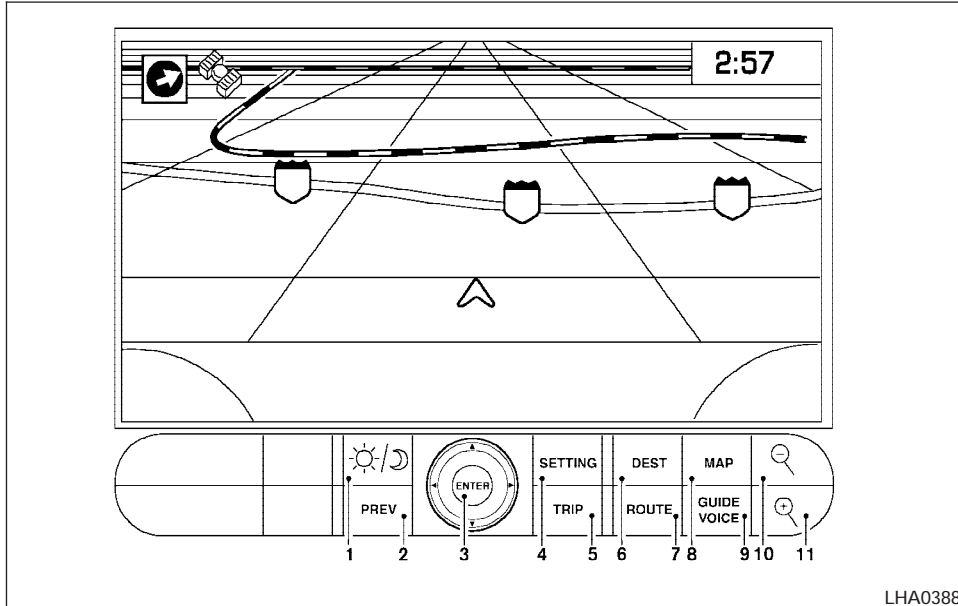

4-2 How do I operate the Infiniti navigation system?

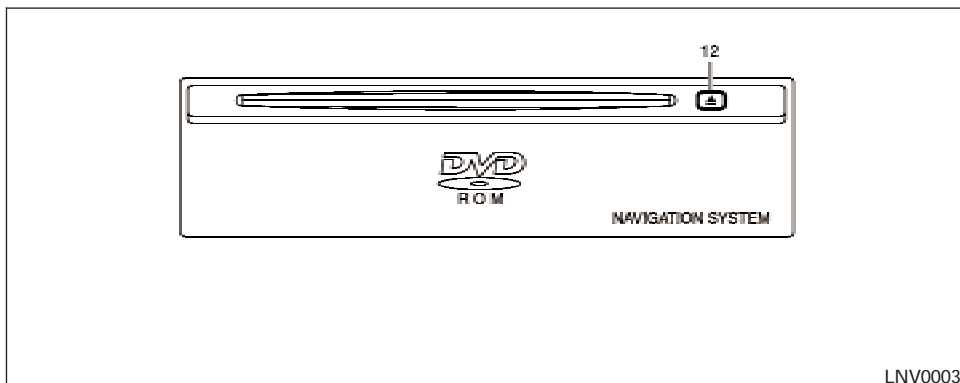

NAMES OF THE COMPONENTS

1. (**DAY/NIGHT**) button; refer to vehicle's Owner's Manual. Changes display brightness.
2. **PREV** button; refer to page 4-4. Returns to the previous screen during setup. Finishes the setup after it is completed.
3. **JOYSTICK** and **ENTER** button; refer to the next section. Scrolls the map, selects and sets each setting item.
4. **SETTING** button; refer to page 4-4. Performs various adjustments and settings to help you use the navigation system more effectively.
5. **TRIP** button; refer to vehicle's Owner's Manual. Displays warning messages (if there are any) and displays TRIP 1 → TRIP 2 → FUEL ECONOMY → MAINTENANCE each time you press the button.
6. **DEST** button; refer to page 4-7. Displays the "Set a Destination" menu.
7. **ROUTE** button; refer to page 4-8. Displays the setting menu screen at the time of route calculation.
8. **MAP** button; refer to page 5-36. Toggles between the intersection and the map during route guidance. Returns to the map screen from the settings screen.
9. **GUIDE VOICE** button; refer to page 10-3. Provides voice guidance from the current location.
10. (**ZOOM OUT**) button; refer to page 11-6. Alters the scale of the map display.
11. (**ZOOM IN**) button; refer to page 11-6. Alters the scale of the map display.
12. (**EJECT**) button; refer to page 4-10. Ejects the DVD.

HOW TO USE THE JOYSTICK AND THE ENTER BUTTON

The navigation system is operated by selecting keys on the screen with the joystick and pressing the joystick in to ENTER your selection. Be sure to understand the operation of the joystick before using the navigation system.

Selecting the keys on the screen

Use the joystick to select keys on the screen.

The joystick can be tilted in eight directions. The selected key will be highlighted in yellow.

INFO:

Use the joystick to scroll the map.

Selecting the function of the high-lighted key

Press the ENTER button.

The display shows the screen used to carry out the function of the selected key (highlighted in yellow).

HOW TO USE THE **PREV** BUTTON

This button has two functions.

To return to the previous screen:

When this button is pressed during setup, setup will be canceled, and the screen will return to the previous screen.

To finish the set-up:

When this button is pressed after set-up is completed, the settings will be renewed as directed, and the screen will return to the map.

INFO:

When the **PREV** button must be pressed, (for example, after the set-up is finished) instructions are given in the operation procedure of each section in this manual. If the **PREV** button is pressed when not finished with the set-up, the setting will be canceled, and the screen will return to the previous screen.

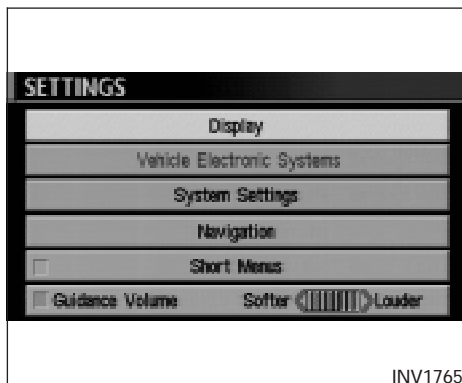

HOW TO USE THE **SETTING** BUTTON

When the **SETTING** button is pressed, the [SETTINGS] screen is displayed.

WARNING

For safety, some of the functions on the menu will be disabled while the vehicle is moving. To use the temporarily disabled functions, park the vehicle in a safe place, shift to P or N, and set the parking brake.

To use the navigation system more effectively, various adjustments and settings can be performed.

Display key:

The key also adjusts the display Brightness/Contrast/Map Background.

Please refer to page 11-20.

Vehicle Electronic Systems key:

No settings available for the navigation system.

Please refer to vehicle's Owner's Manual.

System Settings key:

Please refer to vehicle's Owner's Manual.

Navigation key:

Changes various settings of the navigation system.

Please refer to page 4-5.

Short Menu key:

This key changes between [Expert Mode] and [Easy Mode].

Please refer to 3-4.

Guidance Volume key:

Adjusts or turns off volume of the voice guidance.

Please refer to “Adjusting the guide volume” on page 10-2.

Help key:

Available only in easy mode (Short menus).

You can see the explanation of navigational functions.

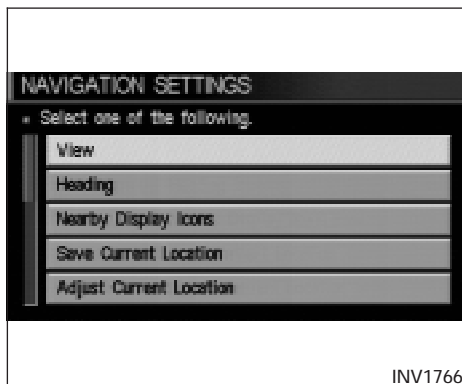

When the **Navigation** key is selected

View key:

This will let you choose between Birdview™ display and Plan View display.

Please refer to “Switching between Birdview™ and Plan View displays” on page 11-3.

Heading key:

You can set the map either to show the vehicle's current forward direction as up, or to show North as up.

Please refer to “Changing the display direction (in Plan View display)” on page 11-7.

Nearby Display Icons key:

Displays five types of points of interest around the current location.

Please refer to “Setting the nearby display icons” on page 6-14.

Save Current Location key:

Stores the current vehicle location in the address book.

Please refer to “Storing current vehicle position” on page 7-4.

Adjust Current Location key:

Corrects the location and direction of the vehicle icon.

Please refer to “Updating the current vehicle location and the direction” on page 11-18.

Auto Re-route On/Off key:

A new route to the desired destination will automatically be calculated again from the location when the vehicle deviates from the suggested route during route guidance.

Please refer to “Automatic re-routing” on page 9-2.

Avoid Area Setting key:

Defines areas to avoid when calculating a route.

Please refer to “Setting avoid areas” on page 8-2.

Clear Memory key:

Clears all the stored memory (Address Book, Avoid Area, Previous Dest.).

Please refer to “Clearing the memory” on page 4-15.

Edit Address Book key:

Changes the names and positions of the registered locations.

Please refer to “Setting up and editing the address book” on page 7-2.

GPS Information key:

GPS information will be displayed.

Please refer to “GPS information display” on page 11-17.

Quick Stop Customer Setting key:

Sets the user-defined [Quick Stop] POI (Point Of Interest).

Please refer to “Quick stop” on page 5-41.

Set Average Speed for Estimated Journey Time key:

Please refer to “Setting the average speed” on page 4-17.

Tracking On/Off key:

You can choose whether to display the path from the start to the current position.

Please refer to “Displaying the track” on page 11-15.

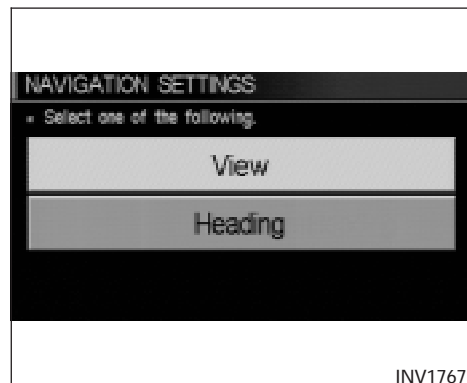

Easy mode — when the

Short Menus key is selected

View key:

Same as in Expert Mode.

Heading key:

Same as in Expert Mode.

4-6 How do I operate the Infiniti navigation system?

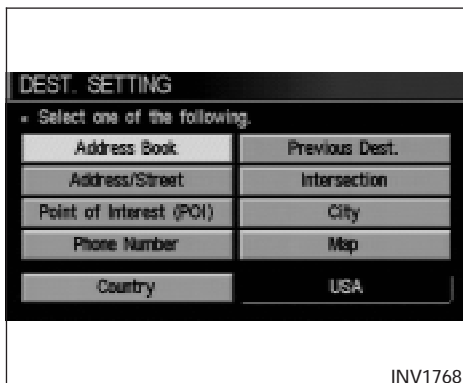

HOW TO USE THE **DEST** BUTTON

Sets destinations (final destination and waypoints) to search for a route.

This will activate various navigational functions.

⚠ WARNING

For safety, some of the functions on the menu will be disabled while the vehicle is moving. To use the temporarily disabled functions, park the vehicle in a safe place, shift to P or N, and set the parking brake.

- **Address Book key:**
Use this category item if you want to go to places stored in the address book. Please refer to "Setting with the **Address Book** key" on page 5-3.
- **Previous Dest. key:**
You can choose destinations from the last 10 destinations set. For details, please refer to "Setting with the **Previous Dest** key" on page 5-5.
- **Address/Street key:**
Use this category item if you know the city name, street name and house number of the destination (waypoints). Please refer to "Setting with the **Address/Street** key" on page 5-7.
- **Intersection key:**
Sets a destination using the intersection of 2 streets. Please refer to "Setting with the **Intersection** key" on page 5-14.
- **Point of Interest (POI) key:**
Use this category item if you want to go to a restaurant, hotel, gas station or other facility.

Please refer to "Setting with the **Point of Interest (POI)** key" on page 5-21.

- **City key:**
Sets the destination (waypoint) on the map screen of the area around the input city. Please refer to "Setting with the **City** key" on page 5-21.
- **Phone Number key:**
Use this category item when the destination phone number is known. Please refer to "Setting with the **Phone Number** key" on page 5-25.
- **Map key:**
Use this category item if you want to choose the place directly on the map display. Please refer to "Setting with the **Map** key" on page 5-27.
- **Country key:**
This key is used to retrieve a location in another country when it is set as the destination (waypoint). Please refer to "Setting with the **Country** key" on page 5-29.

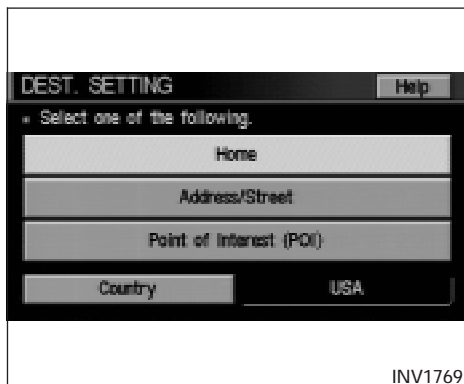

Easy Mode — when the **Short Menu** key is selected

Help key:

You can see the explanation of the navigational functions.

Home key:

When you set your home in the address book, a route home will be calculated by selecting this key.

If the home is not set beforehand, the setting mode will appear to input the home address.

4-8 How do I operate the Infiniti navigation system?

Please refer to “Setting with the **Home** key” on page 5-30.

Address/Street key:

Same as in Expert Mode.

Point of Interest (POI) key:

Same as in Expert Mode.

Country key:

Same as in Expert Mode.

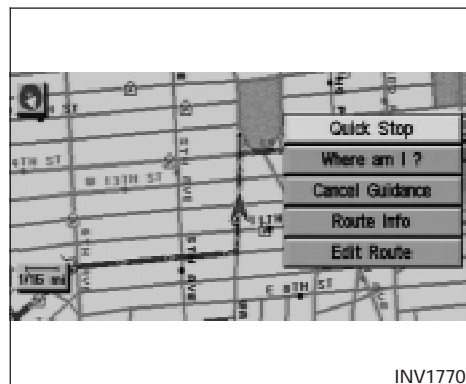

HOW TO USE THE **ROUTE** BUTTON

When the **ROUTE** button is pressed while the current location is displayed on the screen, the display shows the following keys.

INFO:

When no operations are executed after a few seconds, the keys will disappear automatically.

Quick Stop key:

Selects the destination (waypoints) from a list of 5 commonly used POI (Points of Interest).

Please refer to “Quick stop” on page 5-41.

Where am I? key:

Displays the street where the vehicle is currently located, the previous street, and the upcoming street.

Please refer to “Where am I” on page 5-44.

Cancel Guidance key:

Cancels the route guidance.

Please refer to “Cancel guidance” on page 5-45.

Route Info key:

Displays the route to the destination. There are three types of display methods.

● **Complete Route key:**

Displays the entire route from the current location to the destination.

Please refer to “Displaying the complete route to the destination” on page 11-10.

● **Turn List key:**

Displays a list of the guidance points for the entire route to the destination on a simple map.

Please refer to “Displaying turn list” on page 11-11.

● **Route Simulation key:**

Performs a simulation drive on the map screen by moving a vehicle icon on all the routes from the current location to the destination.

Please refer to “Requesting the simulation drive to the destination” on page 11-13.

Edit Route key:

Resets the set destination (waypoint).

Please refer to “Making the system guide the route with detailed options” on page 5-31.

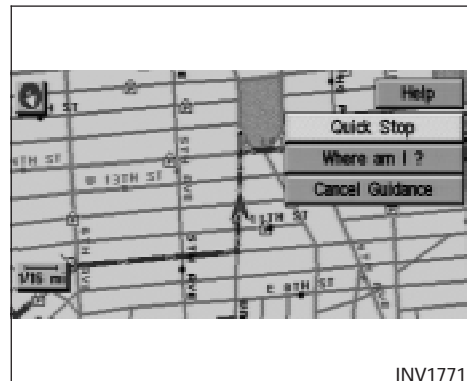

Easy Mode — when the **Short Menus** key is selected

Help key:

You can see the explanation of the navigation functions.

Quick Stop key:

Same as in Expert Mode.

Where am I? key:

Same as in Expert Mode.

HOW TO EJECT/INSERT THE DISC

Cancel Guidance **key:**

Same as in Expert Mode.

Keys that appear when the map is scrolled with the joystick

You can scroll the map display and get information about the area near your vehicle and the destination using the joystick.

INFO:

- This function can be used when the original map disc is inserted.
- You can operate this with the map display on.
- This function cannot be used when the system is calculating the route or drawing the screen.



Store Place **key:**

You can store the location with the cross pointer.

Please refer to “Storing current vehicle position” on page 7-4.

Destination # **key:**

You can set the position as a destination, using the cross pointer. The maximum number of destinations is six, and the last one stored will be the final destination. (# will appear on the map to denote the selected locations from 1 to 6.) Please refer to “Making the system guide the route with detailed options” on page 5-31.

INFO:

The navigation system is installed under the front passenger seat.

This system is provided with the map DVD-ROM.

NOTE:

Please take great care in handling the disc.

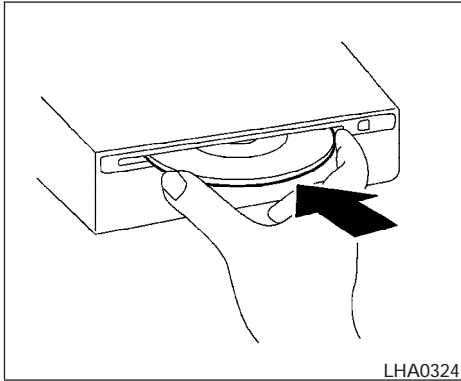

1. Slide the front passenger seat back for easier access to the navigation system.

The map DVD-ROM is mounted under the front passenger seat with the slot facing the front of the vehicle.

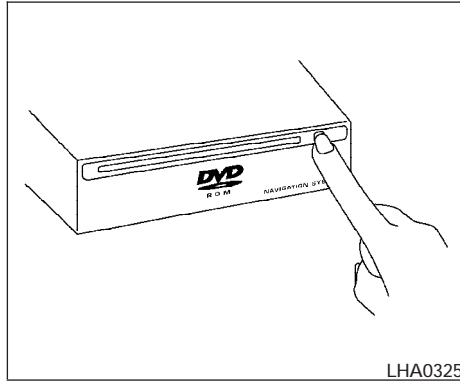

2. To insert a disc:

Place the disc in the slot. It will be drawn in automatically. You do not have to push it in all the way.

3. To eject the disc:

Press the ▲ button, and remove the disc.

⚠ CAUTION

- The included map DVD-ROM is designed specifically for your navigation system. Do not use it in another system as it could cause a malfunction.
- Do not allow the system to get wet. Excessive moisture such as spilled liquids may cause the system to malfunction.

SETTING UP THE START-UP SCREEN

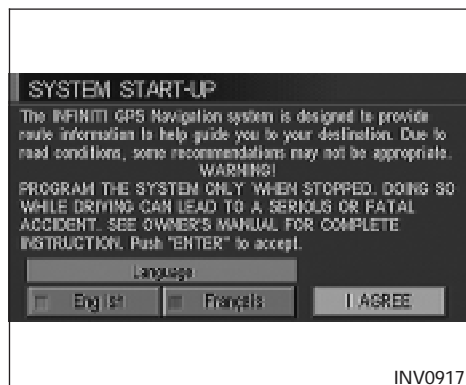

When you turn the ignition key to ACC, the above warning is displayed on the screen. If it is necessary to change language, select one of the languages, then press the ENTER button. Read the warning and select the **I AGREE** (English) or **ENTER** (Français) key.

INFO:

If you do not press the ENTER button within one minute, the display will black out. Pressing either the **MAP**, **ROUTE** or **DEST** button will bring back the start-up screen.

CONFIRMATION OF DESTINATION OR WAYPOINT

When the engine is turned off during route calculation and then turned on, the [CONFIRMATION OF DEST./WAYPOINT] screen will be displayed after the [SYSTEM START-UP] screen.

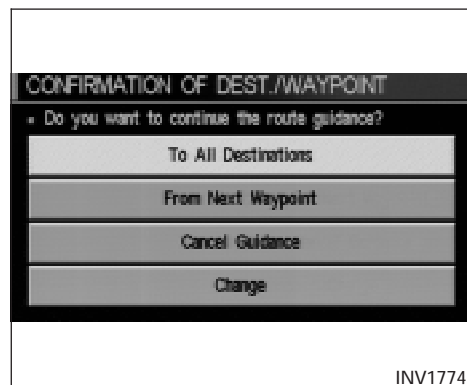

In the [CONFIRMATION OF DEST./WAYPOINT] screen, the following four keys are displayed.

- To All Destinations
- From Next Waypoint
- Cancel Guidance
- Change (only in Expert Mode)

INFO:

When the **PREV** or **MAP** button is pressed in this screen, the [Turn by turn] screen will be displayed.

When the **To All Destinations** key is selected

Route guidance will start to all destinations/waypoints from the current location.

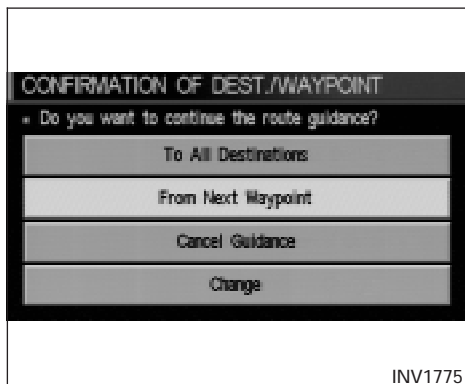

When the **From Next Waypoint** key is selected

Select the **From Next Waypoint** key when you want to start route guidance to the next waypoint/destination.

1. Select the **From Next Waypoint** key.

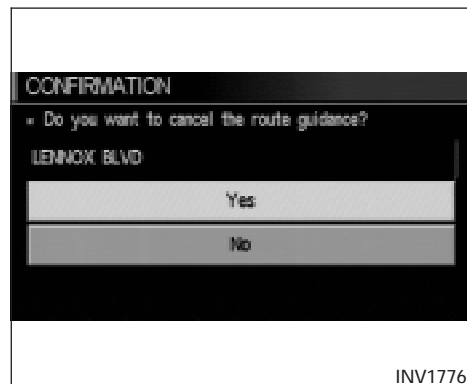

2. When the **Yes** key is selected, route guidance to the current waypoint is deleted and route calculation to the next destination will start.

INFO:

- If you do not want to delete the route guidance, select the **No** key and the screen will return to the map.
- This key can be selected only when a waypoint is set.
- When the **PREV** button is pressed, the previous screen will be displayed.

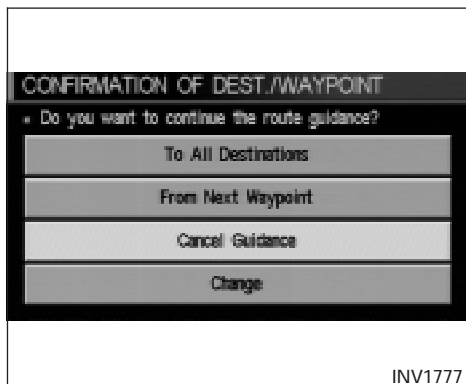

When the **Cancel Guidance** key is selected

The route guidance is cancelled.

1. Select the **Cancel Guidance** key.

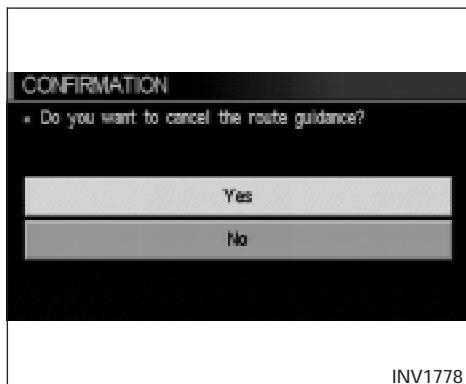

2. When the **Yes** key is selected, route guidance is canceled.

INFO:

- If you do not want to delete the route guidance, select the **No** key and the screen will return to the map.
- Press the **GUIDE VOICE** button to activate the route guidance again.
- When the **PREV** button is pressed, the previous screen will be displayed.

When the **Change** key is selected

It is possible to edit the route guidance to the destination.

INFO:

This key is displayed only in [Expert Mode].

CLEARING THE MEMORY

All the stored data (Address Book, Avoid Area, Previous Dest) can be cleared.

1. Press the **SETTING** button.

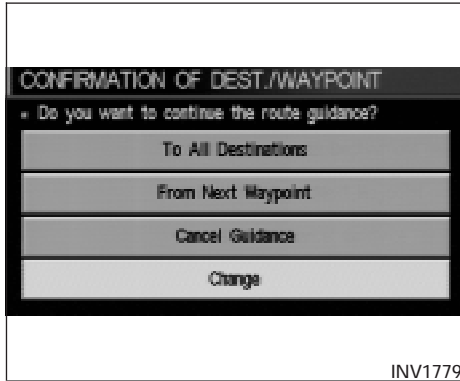

1. Select the **Change** key.

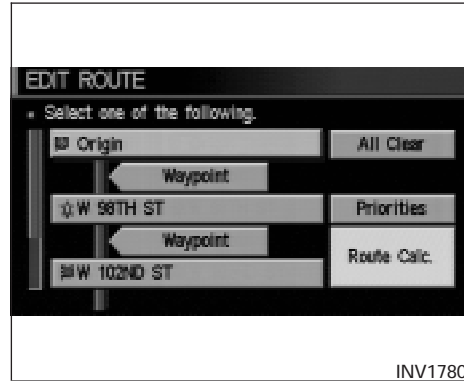

2. The [EDIT ROUTE] screen will be displayed.

Please refer to "Setting with **Country** key" on page 5-29.

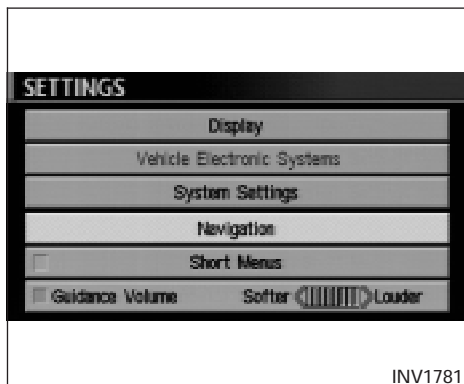

2. Select the **Navigation** key on the [SETTINGS] screen.

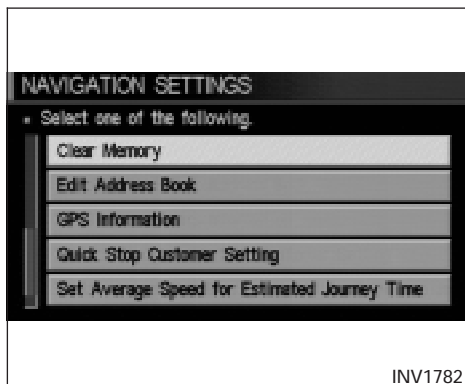

3. Select the **Clear Memory** key.

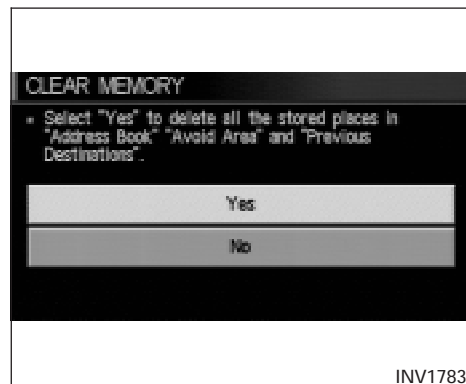

4. Select the **Yes** key.

SETTING THE AVERAGE SPEED



5. When the **Yes** key is selected, the stored data will be cleared, and the [NAVIGATION SETTINGS] screen will appear.

This navigation system can calculate and display the expected arrival time to the destination. To do this, set average vehicle speeds when driving on freeways, main roads and ordinary roads.

The following settings are available.

- Freeway
Default: 55 MPH (90 km/h)
Max: 70 MPH (115 km/h)
Min: 40 MPH (65 km/h)
 - Main Roads
Default: 25 MPH (40 km/h)
Max: 50 MPH (80 km/h)
Min: 10 MPH (20 km/h)
 - Ordinary Roads
Default: 15 MPH (25 km/h)
Max: 35 MPH (55 km/h)
Min: 5 MPH (10 km/h)
1. Press the **SETTING** button.

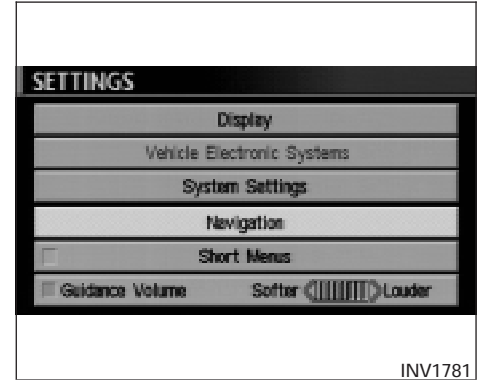

2. Select the **Navigation** key on the [SETTING] screen.

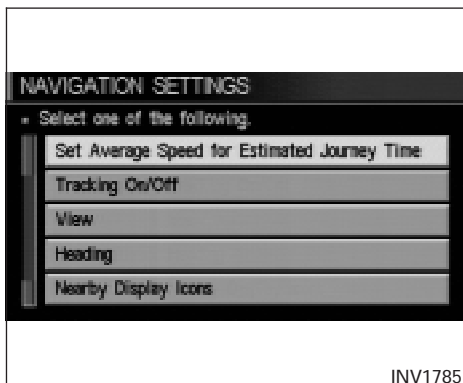

3. Select the

Set Average Speed for Estimated Journey Time
key on the [NAVIGATION SETTINGS]
screen.

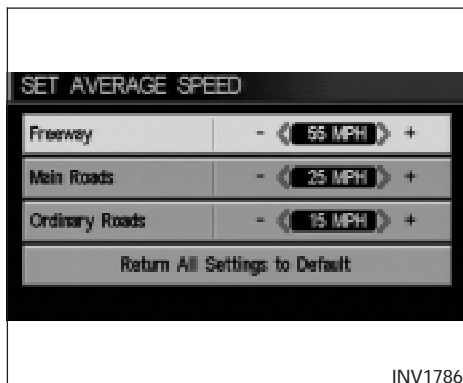

4. Move the joystick upward or downward to select an item you want to change.
5. Move the joystick left or right and set an average vehicle speed.

INFO:

- It is possible to set the item illuminated in yellow.
- When the Return All Settings to Default key is selected, all settings return to default.

ABOUT ROUTE GUIDANCE



- The INFINITI Navigation System may not calculate routes longer than about 1,100 miles (1,770 km). If your trip is longer than 1,100 miles (1,770 km), please divide your trip by selecting one or two intermediate destinations. Set your destination as the first intermediate destination. Once you pass the intermediate destination, you may set your final destination as your destination if it is within 1,100 miles (1,770 km). Otherwise, set your destination using your second intermediate destination.

NOTE:

The navigation system does not take driving in “CAR-POOL LANES” into consideration for the guidance especially when car-pool lanes are separated from other road lanes.

NOTES ON ROUTE GUIDANCE

- The route selected by the system may not be the shortest, nor are other circumstances such as traffic jams considered.
- Because of the inevitable difference in road conditions and circumstances between the time you use this system and the time the information was produced from the DVD, there may be discrepancies in roads and regulations. In such cases, follow the actual information available.

- During route calculation, the map will not scroll, however the vehicle icon will move with the actual vehicle's movement.
- During route calculation, buttons such as **MAP** , **DEST** ,  (**ZOOM OUT**) and  (**ZOOM IN**) and the joystick will be disabled.
- In some cases, after the calculation is complete, it may take some time to get the calculated route on the display.
- Waypoints that have been passed will not be covered by the re-routing calculation.
- If you scroll the map while the suggested route is being drawn, it may take more time to finish drawing.
- If waypoints are set, the system is calculating multiple routes between waypoints simultaneously, and the following may result:
 - If one section (or more) of the routes between the waypoints is not found, none of the route will be displayed.
 - The route may not connect completely at some waypoints.
 - The route may require a U-turn close to some waypoints.
- Route calculation may not be completed in the following cases:
 - If there is no main road within 3.1 miles (5 km) from the vehicle, a message saying so will appear on the screen. Try requesting route calculation when the vehicle is closer to the main road.
 - If there is no main road within 3.1 miles (5 km) from the destination or waypoint, a message saying so will appear on the screen. Try setting the location closer to the main road.
 - If the vehicle is too close to the destination or if there are no branches of the roads to the destination. A message saying so will appear on the screen.
 - If it is deemed impossible to reach the destination or waypoints because of traffic regulations, etc.
 - If the only route to reach the destination or waypoints is extremely complicated.
 - If the destination, current vehicle position or waypoint is within the avoid area.
 - If the setting of avoid areas covers the routes to the destination, route calculation may not be possible.
- The following may occur when the route is being displayed:
 - If you are requesting a calculation from the main road, the origin of the route may not exactly match the current vehicle position.
 - If you are requesting a calculation to a destination on the main road, the end of the route may not exactly match the destination.
 - If you are requesting a calculation from the main road, the system may show a route from another main road. This may be because the icon to show the current vehicle position (vehicle icon) is not set accurately. In that case, park the car in a safe place and reset the vehicle icon, or continue driving to see if the vehicle icon appears on the main road before requesting route calculation again.
 - There are cases in which the system shows a detoured route to reach the destination or waypoints, if you set them from memory or facility information. In order to correct this, you will have to be careful about the traffic direction, especially when the lanes with different travel directions are shown separately. Such

places are interchanges and service areas.

- This system makes no distinction between limited traffic control and total control (blockage). It may show a de-toured route even if the road is usable.
- Even if the freeway preference is set to OFF, the route may be set on them. To avoid this, set a waypoint on another road type and request calculation.
- Even if the preference is set as OFF for a ferry line, the route may be set on it. To avoid this, set a waypoint on a road and request calculation.
- Ferry lines, except those which accept only pedestrians, bicycles and motorcycles, are stored in this system. When using them, take into consideration the travel time required and operational condition to decide whether to use them or not.

ABOUT THE DISPLAY ERROR

The following cases may affect the display accuracy of the vehicle's position or travel direction. The accuracy will return to normal if the driving conditions return to normal:

- When there is a similar road nearby.
- When the vehicle is traveling on a long stretch of straight road or series of curves with a large radius.
- When the vehicle is traveling in an area with a checkerboard road system.
- When the vehicle is making consecutive S curves.
- When the vehicle is at a large Y-shaped junction.
- When the vehicle is on a loop bridge.
- When the vehicle is on a snow-covered or unpaved road.
- When the vehicle has made several consecutive turns or zigzags.
- When the vehicle is rotated on a parking lot turntable while the ignition switch is OFF.
- Immediately after the vehicle is driven out of a parking garage or underground parking lot.

- When the vehicle has different sizes of tires or tire chains.
- When the vehicle is moved immediately after the engine is started.

5 How do I program a destination?

Various ways to set the destination (or waypoint)	5-2
Expert mode categories	5-2
Easy mode categories	5-3
Setting with the Address Book key	5-3
Setting with the Previous Dest. key	5-5
Setting with the Address/Street key	5-7
Setting with the Intersection key	5-14
Setting with the Point of Interest (POI) key	5-21
Setting with the City key	5-21
Setting with the Phone Number key	5-25
Setting with the Map key	5-27
Setting with the Country key	5-29
Setting with the Home key (in easy mode)	5-30
Having the system guide you to the destinations	5-31
Making the system guide the route with detailed options	5-31
Adjusting and deleting the pre-set destination (waypoints)	5-37
To delete a destination	5-39
All clear	5-40
Quick stop	5-41
Quick stop customer setting	5-42
Where am I?	5-44
Cancel guidance	5-45
When the All Destinations key is selected	5-45
When the Waypoint 1 key is selected	5-46
When the Do not Cancel key is selected	5-46

VARIOUS WAYS TO SET THE DESTINATION (or waypoint)

WARNING

To operate the navigation system or to use the screen functions, first park the vehicle in a safe place and set the parking brake. Using the system while driving can distract the driver and may result in a serious accident.

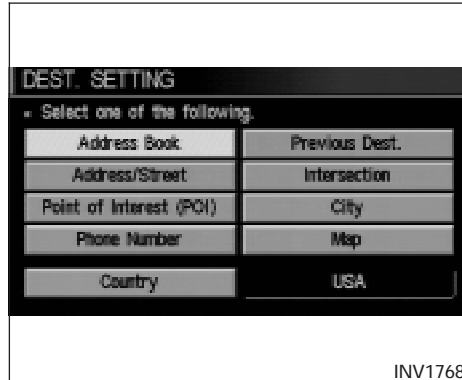

- Phone Number
- Map

EXPERT MODE CATEGORIES

To set the destination and waypoints, you can choose from the eight categories described below. Use these options to choose the best way to find the route to the destinations and waypoints.

- Address Book
- Previous Dest
- Address/Street
- Intersection
- Point of Interest (POI)
- City

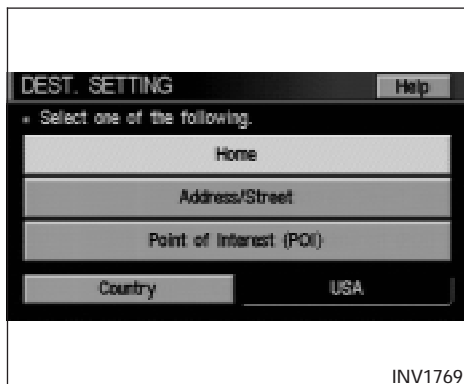

EASY MODE CATEGORIES

When the Expert Mode is canceled, the following three categories will be displayed as Easy Mode.

- Home
- Address/Street
- Point of Interest (POI)

INFO:

- Use the **Address/Street** key and the **Point of Interest (POI)** key in the same way as in Expert Mode. Please refer to “Setting with

the **Address/Street** key” on page 5-3 and “Setting with the **Point of Interest (POI)** key” on page 6-2.

- If the **Short Menu** key is highlighted in amber in the [SETTING] screen, the screen is in Easy Mode. In this case, the keys displayed are different from the screen in Expert Mode.
- If you set a destination or waypoints, they will be displayed with icons.
- If you want to go to places close to the stored locations or facilities, use categories such as facility, nearby facility or memory for easier setting.
- When using either the Point of Interest (POI) or nearby Points of Interest categories, the names called up can be set as the destination if you do not scroll the screen. If you want to choose a different place on the screen from the one called up, you will have to scroll the screen.

SETTING WITH THE

Address Book KEY

The Address Book will allow you to store locations in the memory. This is especially useful for locations that you visit frequently.

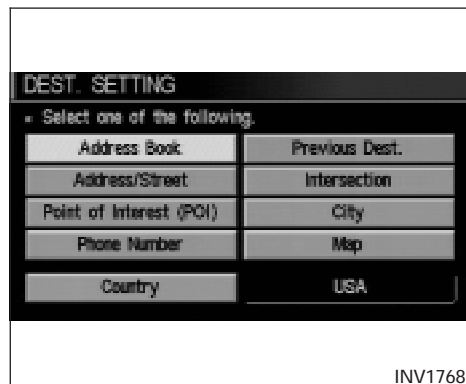

Please refer to “Setting up and editing the address book” on page 7-2.

1. Press the **DEST** button.
2. Select the **Address Book** key on the [DEST. SETTING] screen.

The [DEST. SETTING (Address Book)] screen will be displayed.

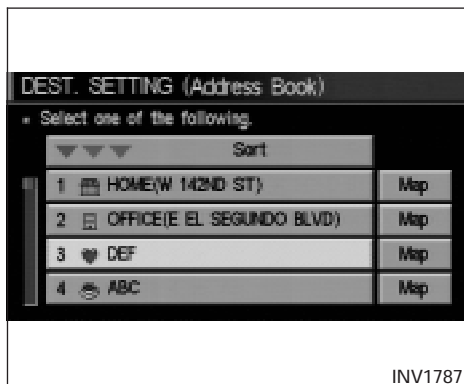

3. Select the item key of your destination (waypoints) on the [DEST. SETTING (Address Book)] screen.

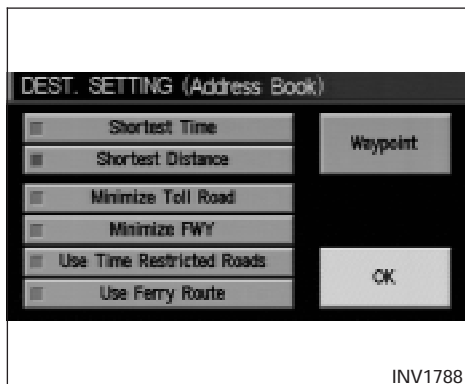

4. To set the destination (waypoints), refer to "Making the system guide the route with detailed options" on page 5-31.

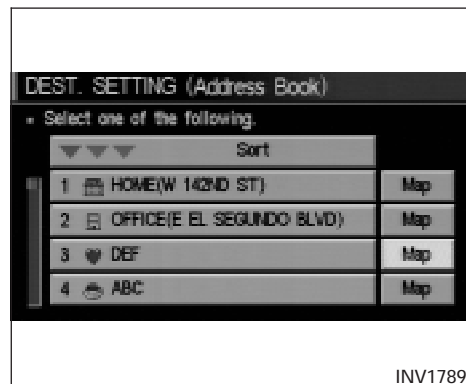

5. To slightly alter the destination.
Select the **Map** key to display the map screen of the area around the specified destination (waypoints).

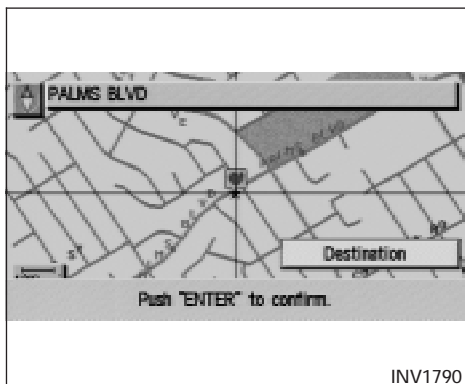

- If necessary, operate the joystick to adjust the location of the destination (waypoint). Press the ENTER button. Select the **Destination** key to confirm. The [DEST. SETTING] screen will be displayed. To set the destination (waypoint), refer to “Making the system guide the route with detailed options” on page 5-31.

INFO:

To change the listing order, select the **Sort** key on the [DEST. SETTING (Address Book)] screen and tilt the joystick to the right or left, or press the ENTER button.

Please refer to “Changing the listing order” on page 7-7.

SETTING WITH THE

Previous Dest. KEY

This system memorizes the last 10 destinations previously chosen, allowing you to set new destinations or waypoints from them.

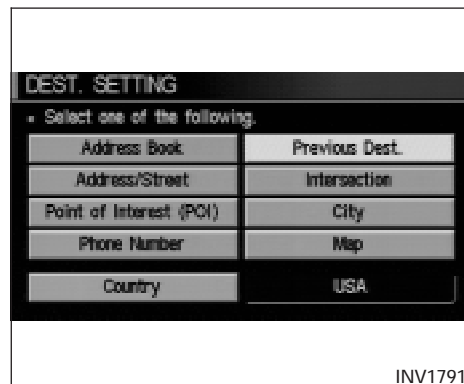

- Press the **DEST** button.
- Select the **Previous Dest.** key on the [DEST. SETTING] screen.

A total of 10 destinations and locations previously set can be stored and displayed.



3. Select the item key of your destination (waypoints) on the [DEST. SETTING (Previous Dest.)] screen.

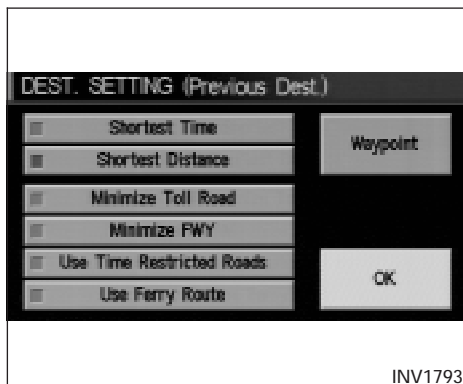

4. To set the destination (waypoints), refer to "Making the system guide the route with detailed options" on page 5-31.

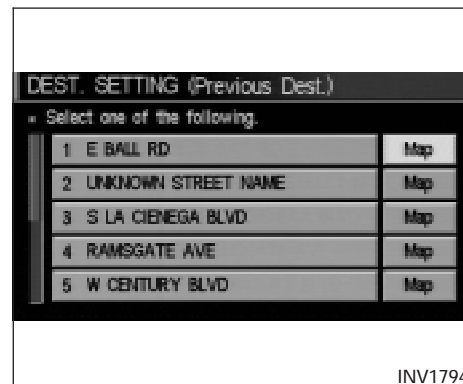

5. To fine tune the destination. Select the **Map** key to display the map screen of the area around the specified destination (waypoints).

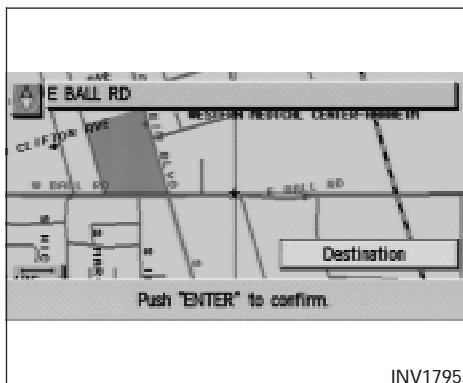

SETTING WITH THE

Address/Street KEY

Sets the destination (waypoints) from the street names and addresses that you enter.

There are two search methods; direct search by the street names, and search by the street names after the state and/or the city are defined.

6. If necessary, operate the joystick to adjust the location of the destination (waypoints). Press the ENTER button. Select the **Destination** key to confirm. The [DEST. SETTING] screen will be displayed. To set the destination (waypoints), refer to "Making the system guide the route with detailed options" on page 5-31.

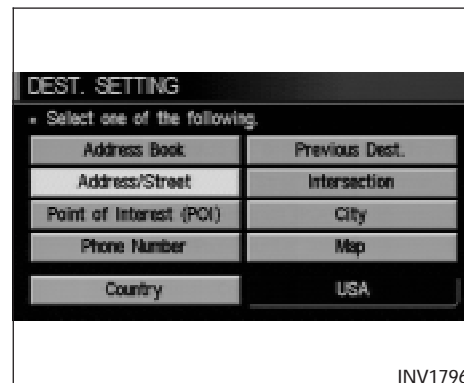

1. First press the **DEST** button.
2. Select the **Address/Street** key.

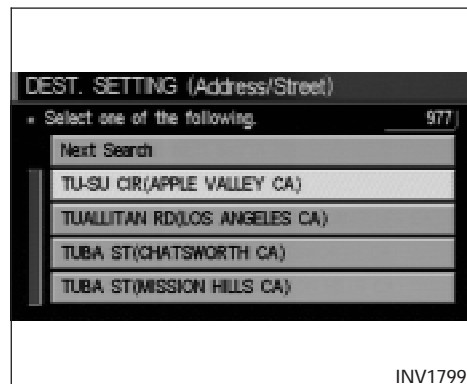
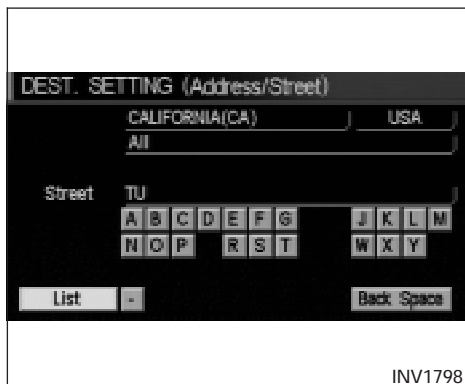
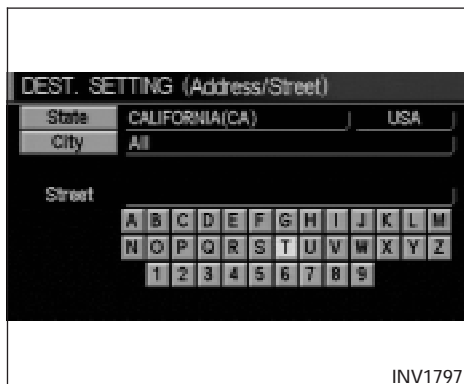

Setting with the **List** key

The **List** key is used when you know the names of the destination and waypoints.

1. A keyboard will be displayed on the [DEST. SETTING (Address/Street)] screen. Enter the street name you want to set.

INFO:

It is not possible to enter names if they are not stored in the DVD-ROM.

2. Enter the street name of your destination. For example, enter **T**, then **U**.
3. Enter **U**, then select the **List** key. The list screen of street names which begin with **TU** will appear.

- If less than 5 suggested streets remain, they will be displayed automatically.
 - The city names and street names will be displayed.
 - Use the joystick to scroll the display if more than 5 suggested street names appear.
 - When the **Next Search** key is selected, it is possible to narrow down cities. To use this function, refer to "Setting with the **City** key" on page 5-21.
 - When the **PREV** button is pressed, the screen to input street names will be displayed.
4. Select one street of your destination.

5-8 How do I program a destination?

DEST. SETTING (Address/Street)			
• Input the house number.		14100-14199	
14150		TU-SU CIR/APPLE VALLEY (CA)	
1	2	3	Back Space
4	5	6	
7	8	9	Map
0			OK

INV1800

5. Enter the house number.

Select the key.

INFO:

It may not be possible to specify a location after selecting the key. In that case, a list of locations which correspond to the entered house number will be displayed.

NOTE:

If a house number is entered and it is not a “direct hit” for house numbers already stored in the database, then only a map to the general vicinity will be displayed.

DEST. SETTING (Address/Street)	
<input type="checkbox"/> Shortest Time	Waypoint
<input type="checkbox"/> Shortest Distance	
<input type="checkbox"/> Minimize Toll Road	OK
<input type="checkbox"/> Minimize FWY	
<input type="checkbox"/> Use Time Restricted Roads	
<input type="checkbox"/> Use Ferry Route	

INV1801

6. To set the destination (waypoints), refer to “Making the system guide the route with detailed options” on page 5-31.

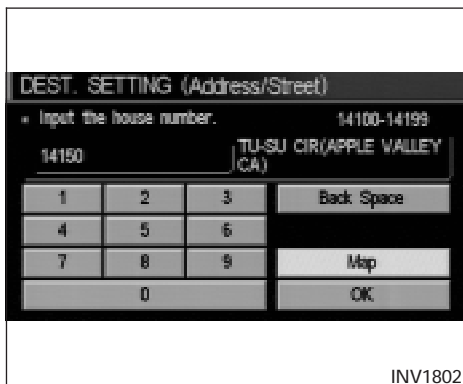

7. To slightly alter the destination.

Select the **Map** key to display the map screen of the area around the specified destination (waypoints).

INFO:

- An approximate location corresponding to the entered house number is displayed. If necessary, correct the location using the joystick.
- The location displayed by the calculation using the house number may differ from the actual location. In that case, correct the location using the joystick.

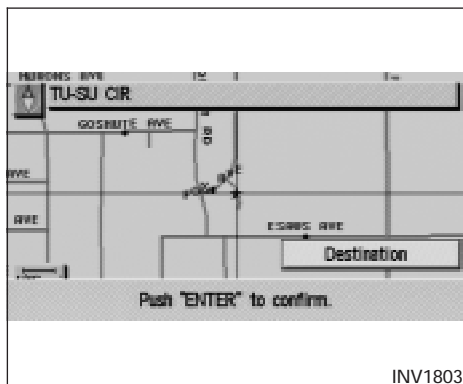

8. If necessary, operate the joystick to adjust the location of the destination (waypoint). Press the ENTER button. Select the **Destination** key to confirm. The [DEST. SETTINGS (Address/Street)] screen will be displayed..

To set the destination (waypoint), refer to “Making the system guide the route with detailed options” on page 5-31.



Setting with the **State** key

The **State** key is used when you select a state/province to set the destination.

1. Select the **State** key.

5-10 How do I program a destination?

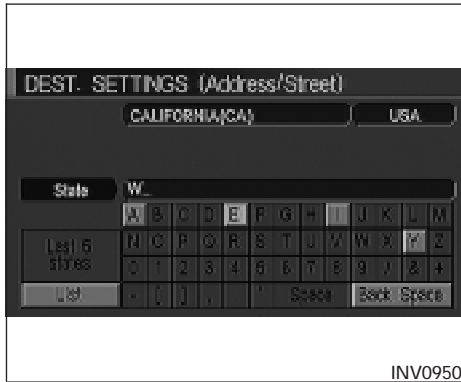

2. The display shows the screen to select states. Input a state/province name.

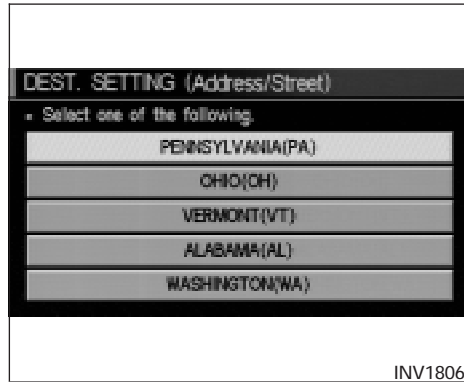

When the **Last 5 States** key is selected, the history of the previous five settings will be listed.



3. The display shows the state list. Select a state/province name.

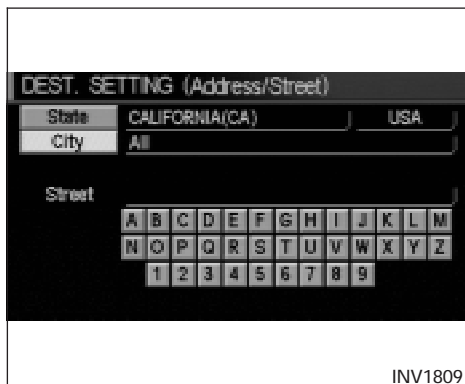

- The screen returns to the [DEST. SETTING (Address/Street)] screen. When the state/province is set, the display shows the selected state/province next to the

[State] key.

Input the street name.
Please refer to "Setting with the [List] key" on page 5-8.

Setting with the [City] key

The [City] key is used when you select a city to set the destination.

- Select the [City] key.
- The display shows the screen to retrieve cities.

- Input a city name.



When the [Last 5 Cities] key is selected, the history of the previous five settings will be listed.

INFO:

It is not possible to select cities if they are not in the state/province you set.



- The display shows the city list.
Select a city of your choice.



- The screen returns to the [DEST. SETTING (Address/Street)] screen.

When the city is set, the display shows the selected city next to the [City] key.

Input the street name of your choice.

Proceed to “Setting with the [List] key” on page 5-8.

SETTING WITH THE **Intersection** KEY

This will allow you to set an intersection as a destination (waypoints).

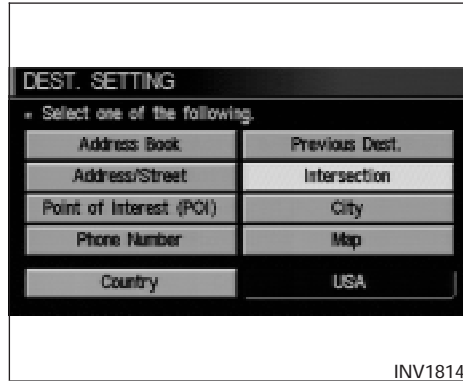

The screenshot shows a menu titled "DEST. SETTING" with a prompt "Select one of the following." Below the prompt is a list of options arranged in two columns:

Address Book	Previous Dest.
Address/Street	Intersection
Point of Interest (POI)	City
Phone Number	Map
Country	USA

The text "INV1814" is visible in the bottom right corner of the screen.

1. Press the **DEST** button.
2. Select the **Intersection** key.
A keyboard will be displayed.

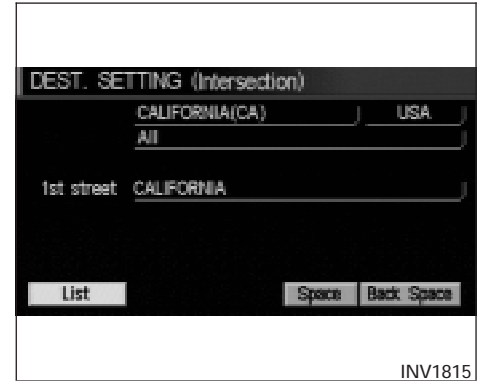

The screenshot shows a keyboard titled "DEST. SETTING (Intersection)". It features two dropdown menus at the top: "CALIFORNIA(CA)" and "USA". Below these is a text input field containing "All". A label "1st street:" is followed by another text input field containing "CALIFORNIA". At the bottom, there are three buttons: "List", "Space", and "Back Space". The text "INV1815" is visible in the bottom right corner of the screen.

Setting with the **List** key

The **List** key is used when you know the names of the destinations and waypoints.

1. Enter the first street name where the destination (waypoints) is located using the keyboard, then select the **List** key.



2. Select the first street name using the same procedures as “Setting with the key”.

INFO:

- When the key is selected, it is possible to narrow down states and cities. To use this function, refer to “Setting with the key” on page 5-21.
- For a road where lanes with different traffic directions are shown separately, the list shows first street name, second street name, ...

- When entering a street name, enter a minor street name as the first street and the calculation will be easier and quicker.



3. Enter the 2nd (intersecting) street name, then select the key.

INFO:

If there are less than 5 streets which intersect the first street, they will be displayed automatically.



4. Select the name of the second street.
The [DEST. SETTING (Intersection)] screen will appear.

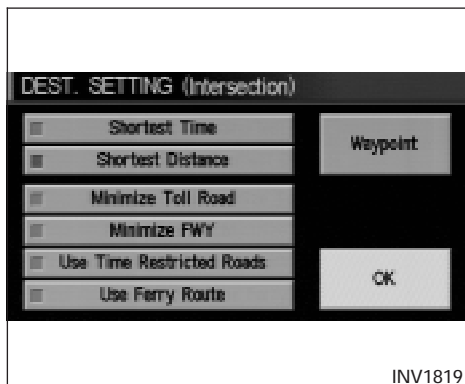

5. To set the destination (waypoints), refer to "Making the system guide the route with detailed options" on page 5-31.

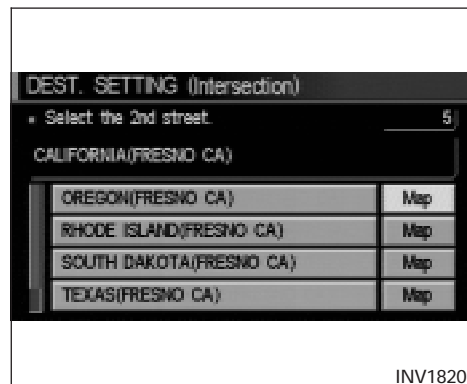

6. To slightly alter the destination.
Select the [Map] key to display the map screen of the area around the specified destination (waypoints).

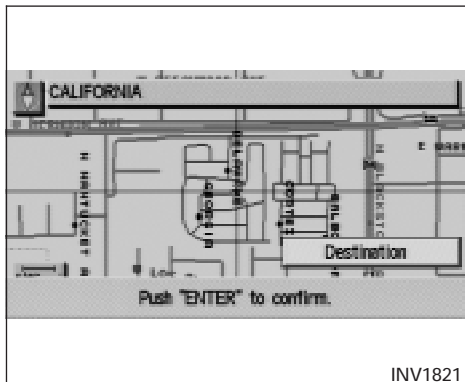

NOTE:

When the corresponding data does not exist under the following conditions, the street name list may not be displayed:

- A street name is being input after the key has been selected.
- List is being displayed by selection of the key.

7. If necessary, operate the joystick to adjust the location of the destination (waypoint). Press the ENTER button. Select the key to confirm. The [DEST. SETTINGS (Intersection)] screen will be displayed.

To set the destination (waypoint), refer to “Making the system guide the route with detailed options” on page 5-31.



Setting with the key

The key is used when you select a state/province to set the destination.

1. Select the key.

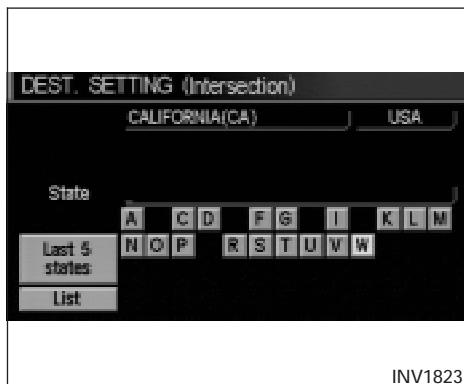

2. The display shows the screen to select states.

Input a state/province name.

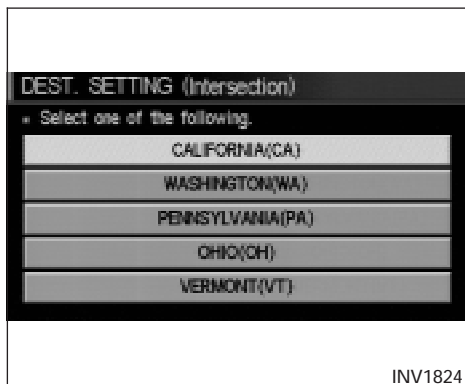

When the **Last 5 States** key is selected, the history of the previous five settings will be listed.



3. The display shows the state list.

Select a state/province name.

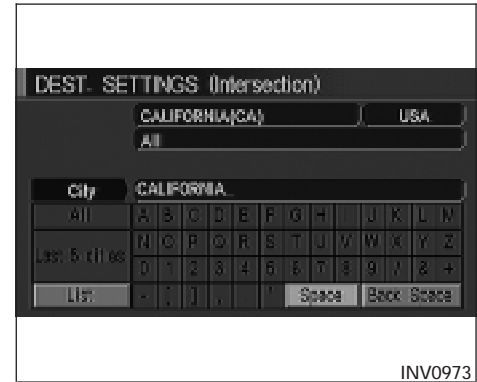

- The screen returns to the [DEST. SETTING (Intersection)] screen.

When the state/province is set, the display shows the selected state/province next to the [State] key.

Input the street name.
Please refer to “Setting with the [List] key” on page 5-14.

Setting with the [City] key

The [City] key is used to retrieve an intersection from the specified city to set the destination.

- Select the [City] key.
- The display shows the screen to retrieve cities.

- Input a city name.



When the **Last 5 Cities** key is selected, the history of the previous five settings will be listed.

INFO:

It is not possible to select cities if they are not in the state/province you set.



- The display shows the city list.
Select a city of your choice.



- The screen returns to the [DEST. SETTING (Intersection)] screen.

When the city is set, the display shows the selected city next to the **City** key.

Input the street name of your choice.

Proceed to “Setting with the **List** key” on page 5-14.

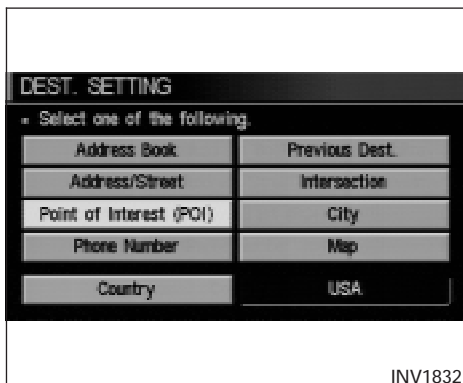

SETTING WITH THE **City** KEY

Sets the destination (waypoints) on the map screen of the area in and around the input city.

1. Press the **DEST** button.

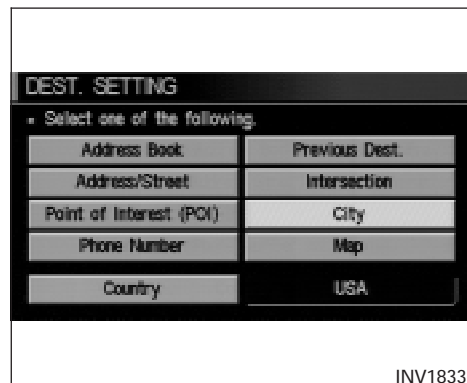

SETTING WITH

THE **Point of Interest (POI)** KEY

The INFINITI Navigation System includes a database of Point of Interest (POI) locations such as restaurants, hotels, and gas stations. (refer to section 6.)

By using this feature, you can set a Point of Interest location as a destination. For details on how to use the POI feature, please refer to section 6.

2. Select the **City** key on the [DEST. SETTING] screen.

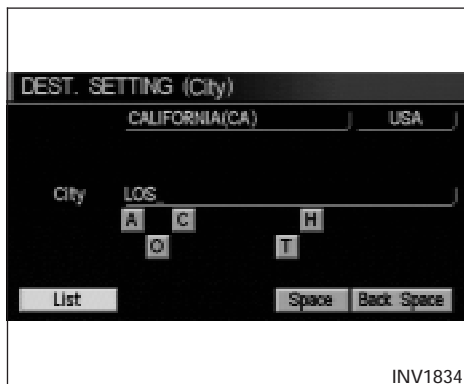

Setting with the **List** key

The **List** key is used when you know the names of the destination and waypoints.

1. Enter the characters of the city name which you wish to set as a destination (waypoints) using the keyboard on the [DEST. SETTING (City)] screen, then select the **List** key.

INFO:

- When the **List** key is selected, the data of the currently-listed cities will be displayed.
- If less than 5 suggested cities remain, they will be displayed automatically.

5-22 How do I program a destination?



2. Select the city name of your destination (waypoints) on the [DEST. SETTING (City)] screen.

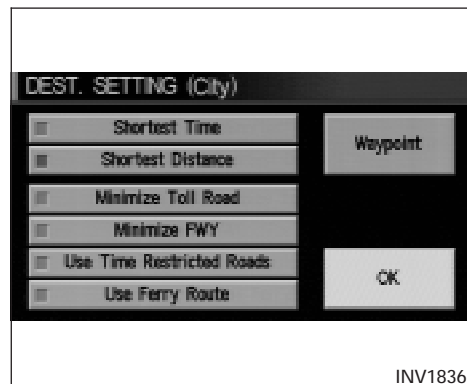

3. To set the destination (waypoints), refer to "Making the system guide the route with detailed options" on page 5-31.



4. To slightly alter the destination.

Select the **Map** key to display the map screen of the area around the specified destination (waypoints).

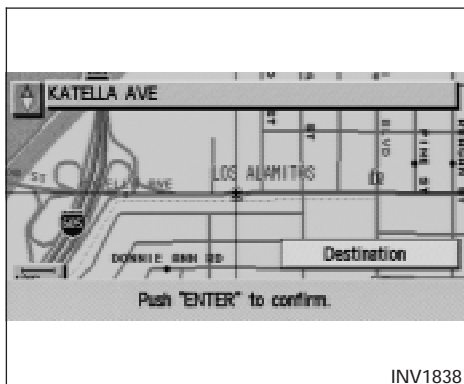

5. If necessary, operate the joystick to adjust the location of the destination (waypoints). Press the ENTER button. Select the **Destination** key to confirm.

The [DEST. SETTING (City)] screen will be displayed.

To set the destination (waypoints), refer to "Making the system guide the route with detailed options" on page 5-31.

- **List is being displayed by selection of the **List** key.**



Setting with the **State** key

The **State** key is used when you select a state/province to set the destination.

1. Select the **State** key.

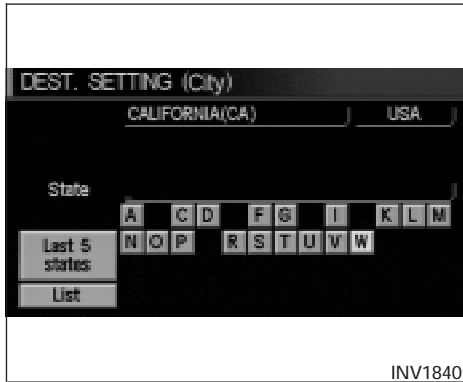

2. The display shows the screen to select states/provinces.

Input a state/province name.



When the **Last 5 States** key is selected, the history of the previous five settings will be listed.



3. The display shows the state/province list.

Select a state/province name.



- The screen returns to the [DEST. SETTING (City)] screen.

When the state/province is set, the display shows the selected state/province next to the [State] key.

Input the street name.

Please refer to “Setting with the

[List] key” on the previous section.

SETTING WITH THE

[Phone Number] KEY

NOTE:

This option only works when the destination is listed in the POI directory.

Sets the destination (waypoints) on the map screen of the area and around the input phone number.

- Press the [DEST] button.

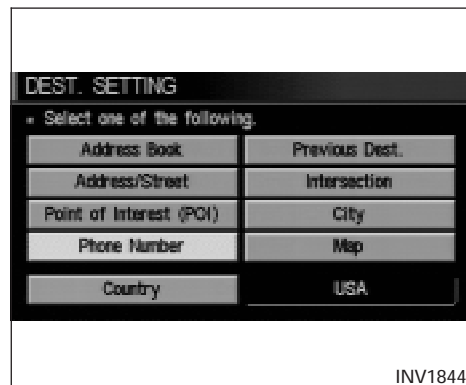

- Select the [Phone Number] key on the [DEST. SETTING] screen.

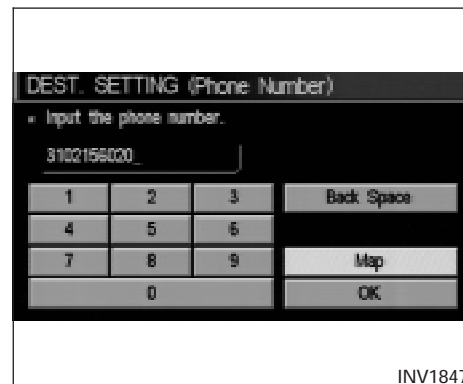
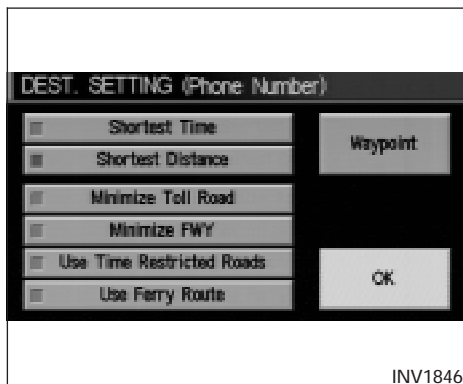
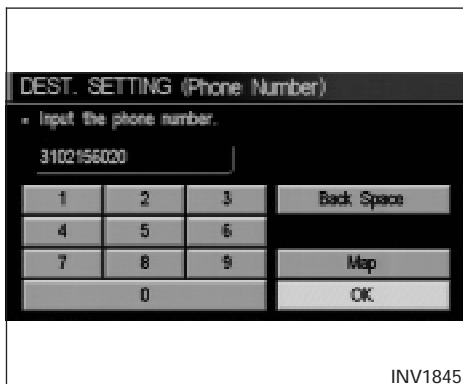

3. Enter the ten digit phone number of the destination (waypoints) using the keyboard on the [DEST. SETTING (Phone Number)] screen.
4. If you select the key, the [DEST. SETTING (Phone Number)] screen will be displayed.

5. To set the destination (waypoints), refer to "Making the system guide the route with detailed options" on page 5-31.

6. To slightly alter the destination.
Select the key to display the map screen of the area around the specified destination (waypoints).

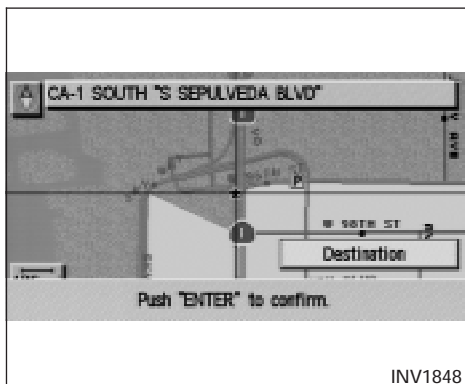

7. If necessary, operate the joystick to adjust the location of the destination (waypoints).

Press the ENTER button.

Select the **Destination** key to confirm.

To set the destination (waypoints), refer to "Making the system guide the route with detailed options" on page 5-31.

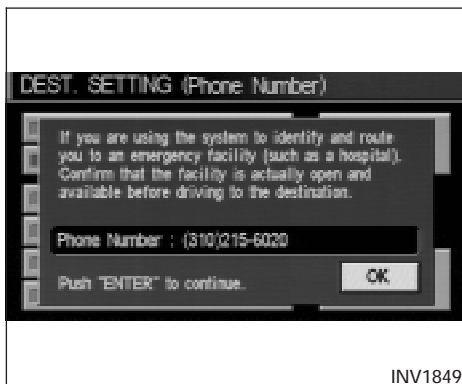

INFO:

When a hospital is set as a destination, a telephone number of the destination will be displayed.

SETTING WITH THE **Map** KEY

This will enable you to zoom into the map for detail and set the desired location. This works best when you know the location geographically, or want to check the geographical surroundings on the map before setting the destinations.

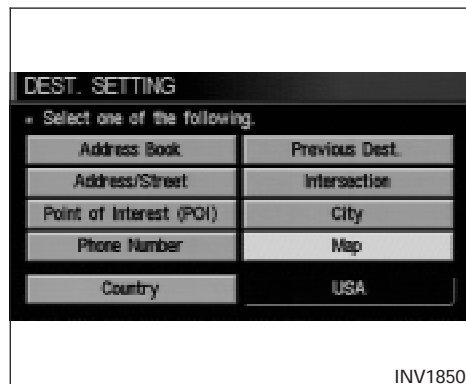

1. Press the **DEST** button.
2. Select the **Map** key.

The map of the entire area will be displayed.

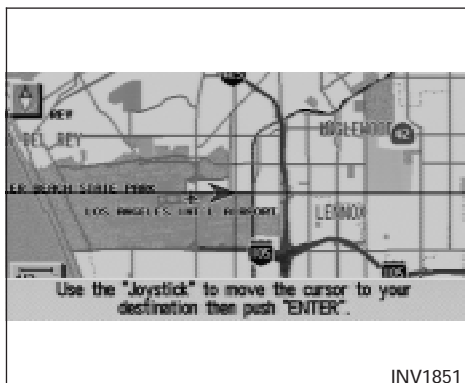

3. Operate the joystick to choose the destination (waypoints).

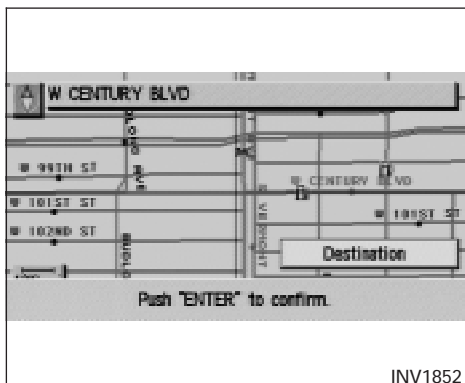

4. Adjust the location using the joystick, and press the ENTER button.

5. Select the key.

The [DEST. SETTING] screen will appear.

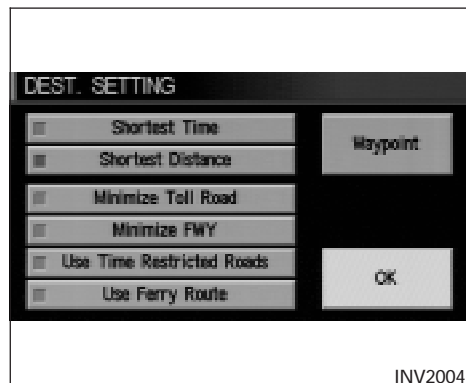

6. Please refer to "Making the system guide the route with detailed options" on page 5-31.

INFO:

When the key is selected in the [DEST. SETTING] screen, route calculation starts. If you want to add waypoints, select the key.

SETTING WITH THE **Country** KEY

When the **Address/Street** , **Intersection** ,

City , or **Point of Interest (POI)** key is used to set the destination (waypoints) in other countries, they are retrieved from the areas in the country which have been set in the country category. When setting the destination (waypoints) in other countries, select a country first.

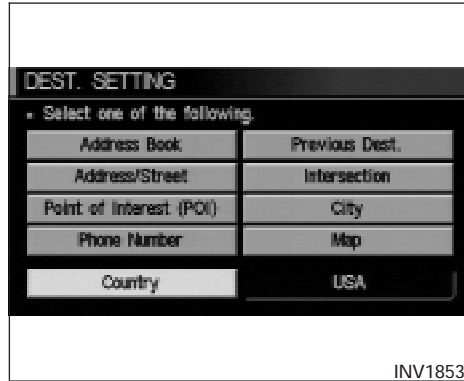

1. Press the **DEST** button.

The [DEST. SETTINGS] screen will be displayed.

Select the **Country** key.

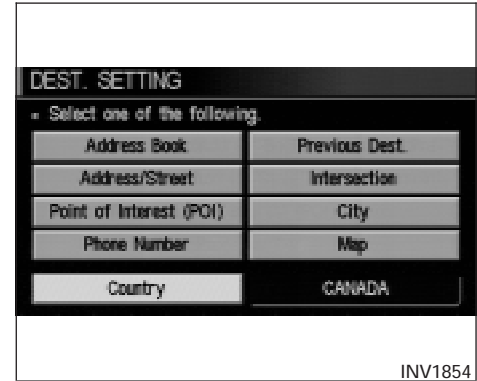

2. Select the **Country** key. Each time the ENTER button is pressed, the country selection toggles between USA and Canada.
3. Then, the selected country will be displayed at the right of the **Country** key.

SETTING WITH THE KEY (in easy mode)

Sets the home as a destination.

INFO:

In the Expert Mode, this key will not be displayed.

Turn on the highlighted amber key in the [SETTING] screen.

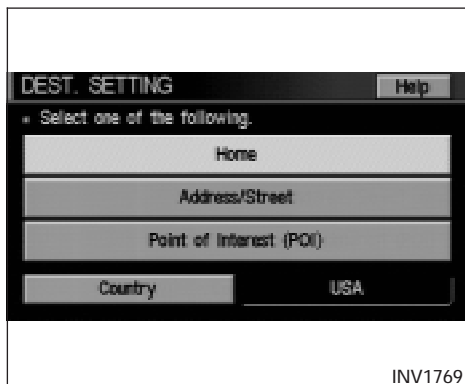

1. Press the button.
2. Select the key.



3. The [DEST. SETTING] screen will be displayed.

Set the key.

To set the destination (waypoints), refer to “Making the system guide the route with detailed options” on page 5-31.

INFO:

If the home is not registered in the Address Book, the [ADDRESS/STREET] screen will be displayed.

Please refer to “Setting with the

key” on page 5-7.

HAVING THE SYSTEM GUIDE YOU TO THE DESTINATIONS

WARNING

To operate the navigation system or to use the screen functions, first park the vehicle in a safe place and set the parking brake. Using the system while driving can distract the driver and may result in a serious accident.

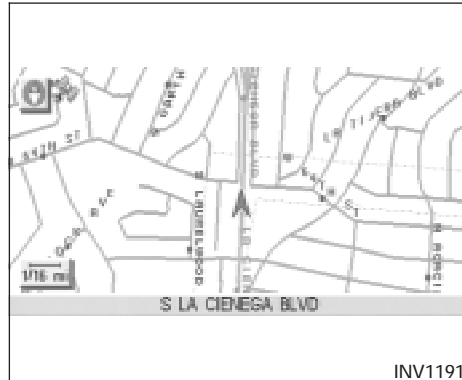

MAKING THE SYSTEM GUIDE THE ROUTE WITH DETAILED OPTIONS

By choosing the destination from the menu, you can choose detailed options such as waypoints and calculation conditions and have the system guide you from the current position to the destination.

Setting the destination

First, you will have to set the destination.

1. Select a destination using one of the methods described earlier in this chapter:
 - Address Book

- Previous Destination
 - Address/Street
 - Intersection
 - Point of Interest (POI)
 - City
 - Phone Number
 - Map
 - Home
2. Set the route priorities and select the key to calculate the route. Refer to “Route calculation and guidance” on page 5-35.

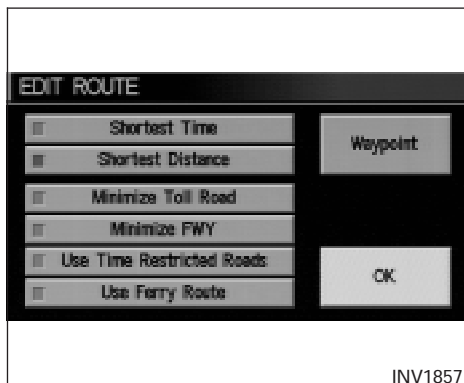

INFO:

- If you select the **OK** key at this point, route calculation will start without any waypoints.
- Press the **PREV** button to display the [EDIT ROUTE] screen.

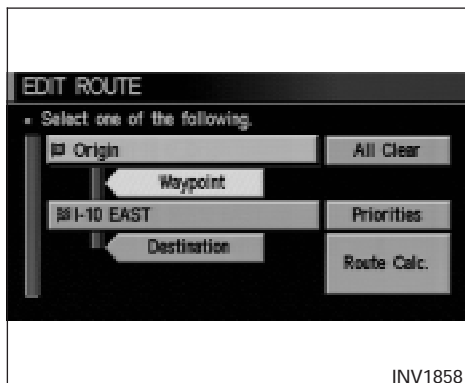

Setting the waypoints

After you set a destination, you can set waypoints.

INFO:

- When the **ROUTE** button is pressed on the map and the **Edit Route** key is selected, the [EDIT ROUTE] screen will be displayed.
- The maximum number of destinations and waypoints that can be set is six (6).

Please refer to “Expert mode categories” on page 5-2.

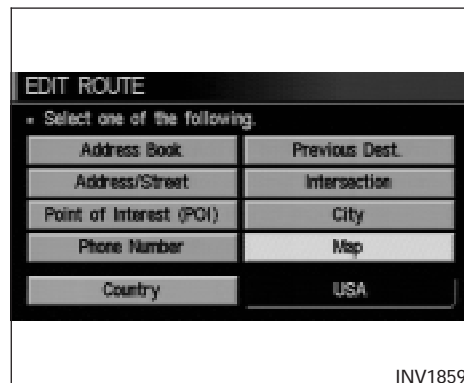

1. Select the **Waypoint** key or **Destination** key on the [EDIT ROUTE] screen.
The [EDIT ROUTE] screen will be displayed.
2. Select a waypoint destination using one of the destination selection procedures outlined earlier in the chapter.

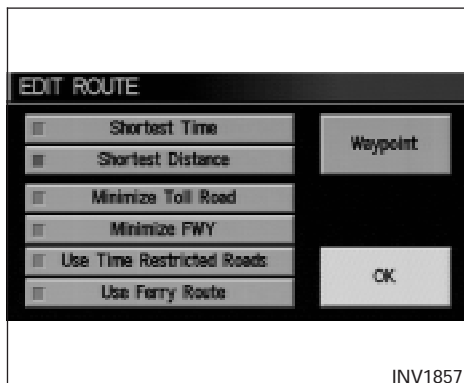

Select the conditions with high priorities.

If you want to get to your destination in the shortest time, select the **Shortest Time** key.

Selecting the key will turn the indicator light in the key ON; selecting it again will turn it OFF.

INFO:

- When you select the **OK** key at this point, route calculation will start without any additional waypoints.
- Press the **PREV** button to display the [EDIT ROUTE] screen.

- It is also possible to set a waypoint by selecting the **Waypoint** key in the [DEST. SETTING] screen.

Setting the priorities for route calculation

After the setting of destinations and waypoints is completed, set the calculation conditions such as route type with high priorities.

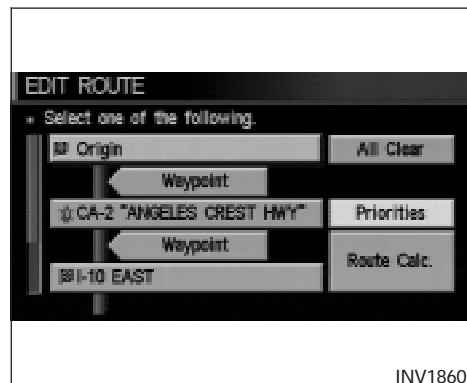

1. Select the **Priorities** key.

The screen for setting calculation conditions will appear. The conditions with the indicator light ON will have high priority.

INFO:

When the **ROUTE** button is pressed on the map and the **Edit Route** key is selected, the [EDIT ROUTE] screen will be displayed.

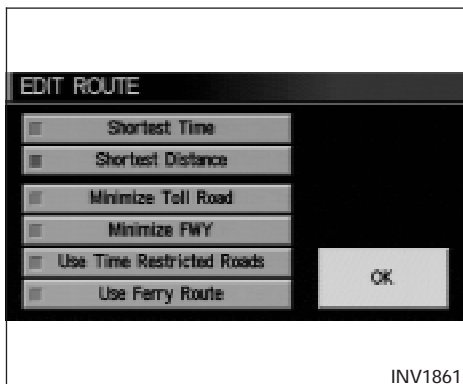

2. Select the conditions with high priorities. Select each key on the screen to turn its respective indicator light ON or OFF.

Shortest Time key:

The route to the destination is calculated so that you can reach the destination in the shortest time. In some cases, a freeway or toll road with detours may be recommended.

NOTE:

It may not be the shortest time in all cases.

Shortest Distance key:

The route to the destination is calculated so that it is the shortest distance.

NOTE:

It may not be the shortest distance in all cases.

Minimize Toll Road key:

The route to the destination is calculated with minimum use of toll roads.

Minimize FWY key:

The route to the destination is calculated with minimum use of freeways.

Use Time Restricted Roads key:

The route using time restricted roads is calculated.

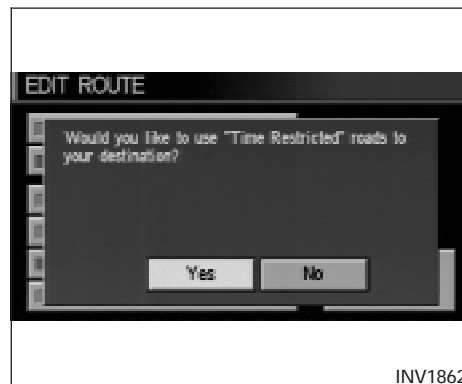

When this key is selected and the **OK** key is pressed, a confirmation screen will be displayed.

When the **Yes** key is pressed, route calculation will start.

INFO:

The system considers time restricted roads as whole-day restricted. When the key is set to OFF, time restricted roads will not be included in route calculation.

⚠ WARNING

When the route is calculated with this key ON, be sure to obey traffic regulations.

Use Ferry Route key:

Select this key if you prefer routes with ferry lines.

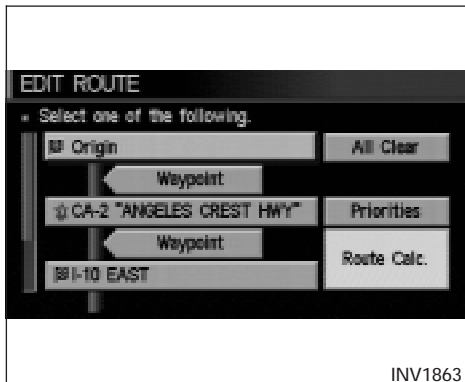

Route calculation and guidance

After setting all the items required, you may proceed to route calculation for guidance. After the route calculation is completed, the guidance will start automatically.

INFO:

When the **ROUTE** button is pressed on the map and the **Edit Route** key is selected, the **[EDIT ROUTE]** screen will be displayed.

Select the **Route calc.** key.

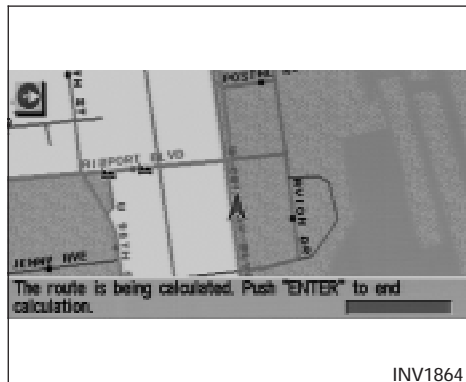

Route calculation screen will be displayed.

The suggested route will be displayed with a thick blue line. If you enter this route, the voice guide will start.

INFO:

- If you want to cancel the route calculation, press the **ENTER** button.
- If you set a place which is not suitable as a destination, the suggested route will not be displayed. In such a case, the **OK** key will be displayed on the screen. Select the **OK** key. Reset a correct destination.

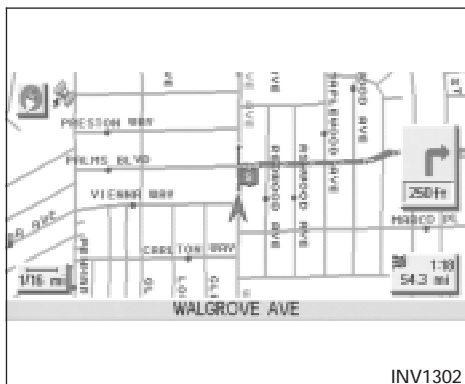

- If route calculation is not possible with all the set preferences, the system may look up a route that does not exactly correspond to the preferences.
- When deleting the settings of destinations or waypoints, press the **ROUTE** button.

Enlarged intersection display

When the vehicle approaches a guide point such as an intersection, the enlarged map of the point will be displayed.

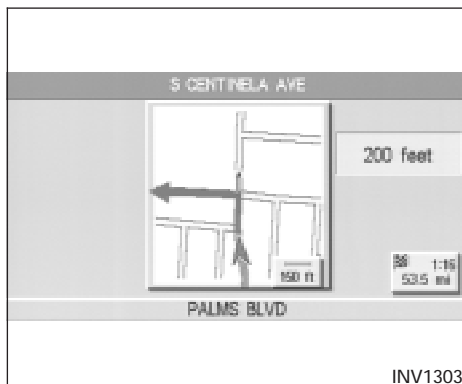

INFO:

- When no operation is executed with the enlarged map displayed, the map stays displayed.
- If route numbers are included in the map data, route numbers will be displayed on the left side of the screen.
- If street names are displayed in two lines, route numbers will not be displayed.

NOTE:

- When the guide point is close to the guidance start point, the enlarged map may not be displayed.
- The guide point name may not be displayed.
- The position of the vehicle icon on the enlarged map may differ from the position on the current display.
 1. Press the **MAP** or **PREV** button.

The map screen will appear.

ADJUSTING AND DELETING THE PRE-SET DESTINATION (waypoints)

Using the joystick, you can **adjust the destination** (waypoints).

1. Press the **ROUTE** button.

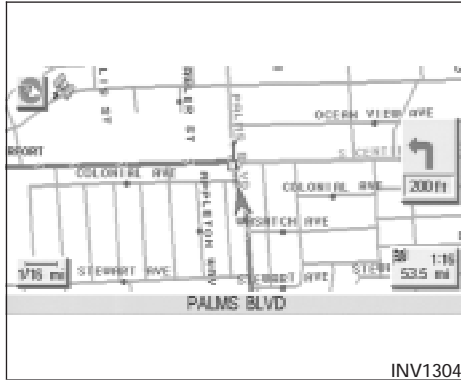

INFO:

To display the enlarged map, press the **MAP** button or **PREV** button.

2. When the vehicle arrives at the neighborhood of the destination, the route guidance will end automatically.

INFO:

- To alternate between the map and the enlarged screen, press the **MAP** button or **PREV** button.
- In the map screen, the distance to the next guide point and the turning direction will be displayed on the right side of the screen.

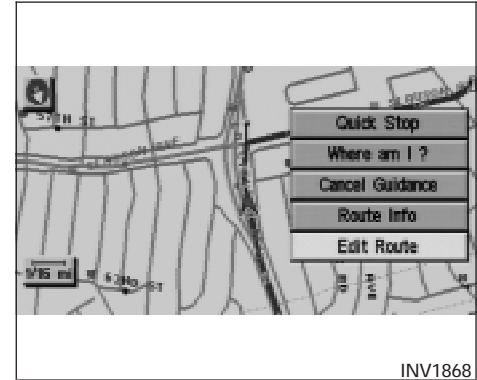

2. Select the **Edit Route** key.

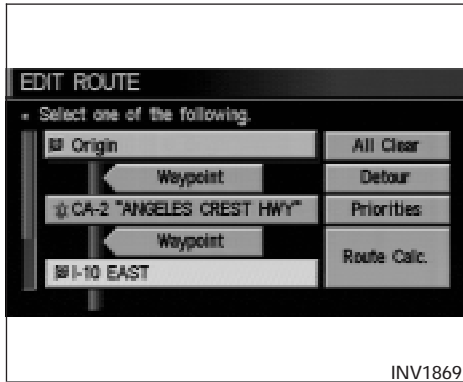

INV1869

3. Choose the destination (waypoints) you want to adjust on the [EDIT ROUTE] screen.

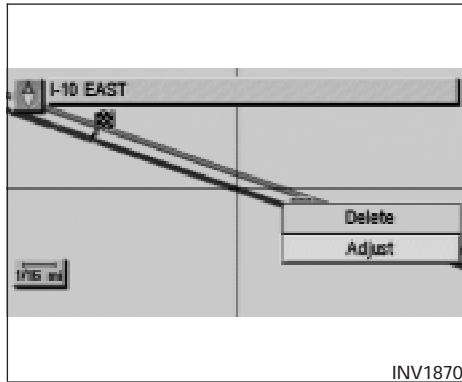

INV1870

4. The map screen will be displayed for adjusting. Use the joystick to adjust the location.

INFO:

When you move the joystick, the **Adjust** key will be displayed.

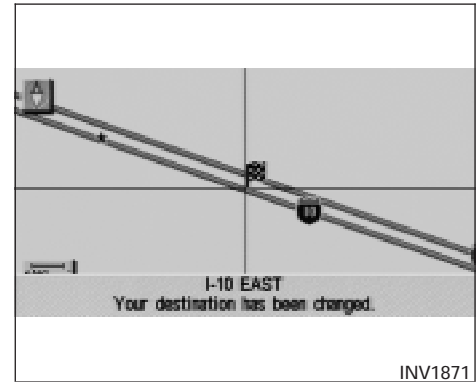

INV1871

5. Select the **Adjust** key.
The new destination (waypoints) will be set.

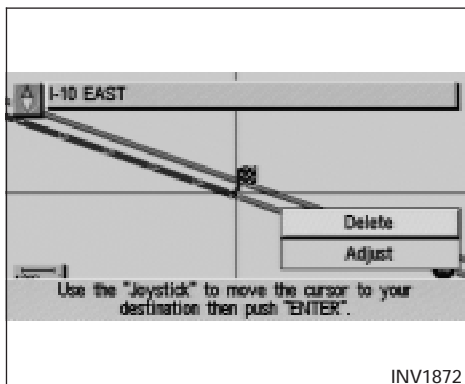

TO DELETE A DESTINATION

1. To delete the destination (waypoint), choose the destination (waypoint) in step 3 and select the **Delete** key.

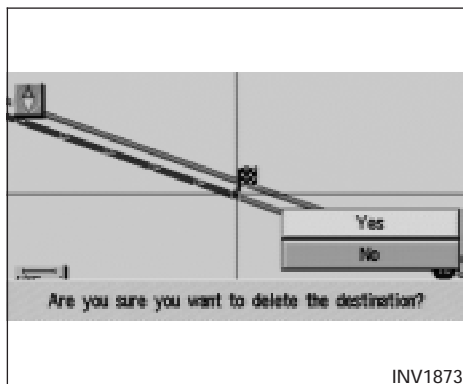

2. Select the **Yes** key.

The preset destination (waypoints) will be deleted.

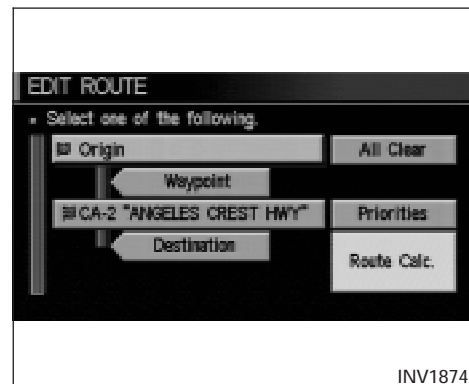

3. Press the **Map** button to return to the map screen.

INFO:

- To set a new destination (waypoints), refer to “Expert mode categories” or “Easy mode categories” on page 5-2.
- If you reset the new destination (waypoints), the older destination (waypoints) will be deleted. If you have requested a route calculation, the previous suggested route will be deleted from memory.

ALL CLEAR

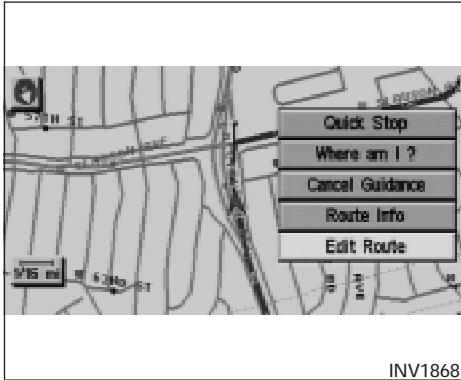

The destination and waypoint can be deleted at one time.

1. Press the **ROUTE** button. Several keys will be displayed on the right of the screen. Select the **Edit Route** key.

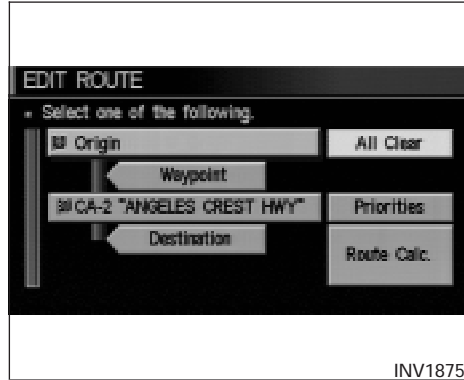

2. The **[EDIT ROUTE]** screen will be displayed. Select the **All Clear** key.

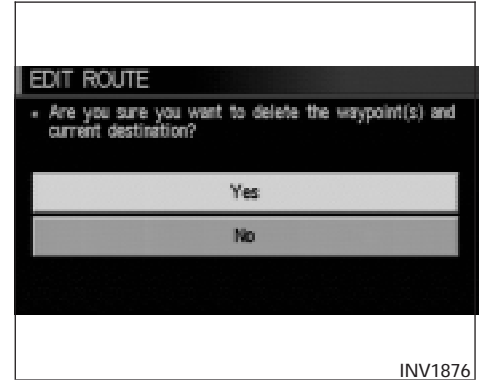

3. Select the **Yes** key.

QUICK STOP

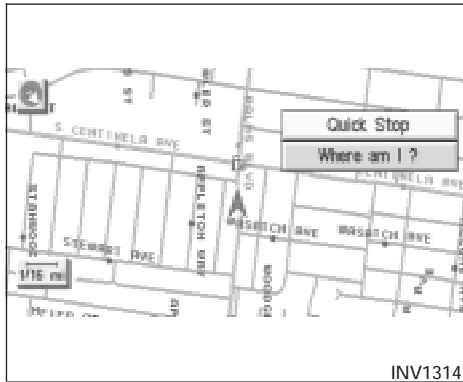

INV1314

The system will display pre-defined POI's (Points of Interest) in the current vicinity of the vehicle and the distances to them. These POI's can be gas stations, hotels, restaurants, ATM's or customer-programmed facilities. This function will operate while the vehicle is moving.

1. Press the **ROUTE** button.

The display shows several keys on the right of the screen.

Select the **Quick Stop** key.

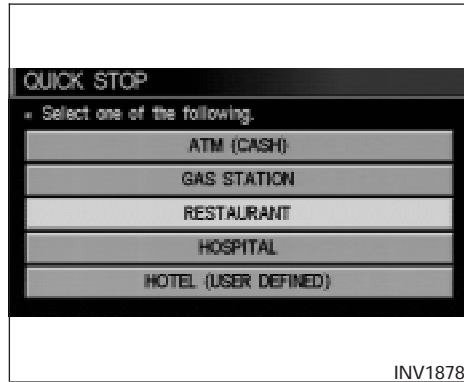

INV1878

2. The display shows the **[QUICK STOP]** screen.

Select the category of your choice.

INFO:

Five categories are displayed on the screen. The last one can be customized. When you use a POI category frequently, it is convenient to use the quick stop function. Please refer to "Quick stop customer setting" on page 5-42.

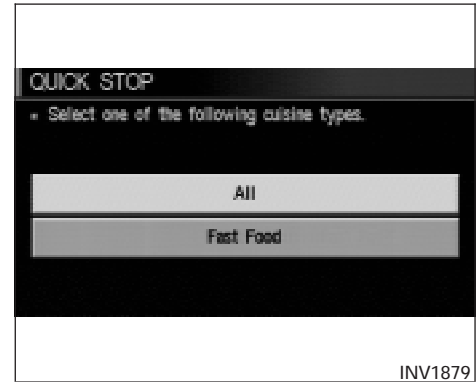

INV1879

3. The cuisine selection screen is displayed only when the **RESTAURANT** key is selected. Select the **All** key or **Fast Food** key.



4. The display shows the direction and distance from the current vehicle position to the selected facility.

Select the facility name you want to set as a destination (waypoints).

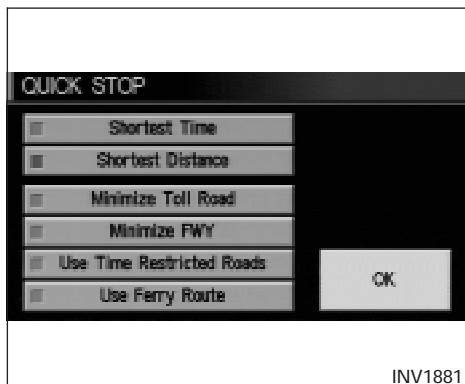

5. Set route priorities, then select the **OK** key. Route calculation to the destination will be started.

INFO:

If quick stop is set after the destination was set, the system starts the route calculation to the location as the waypoint. Five waypoints can be registered at the same time.

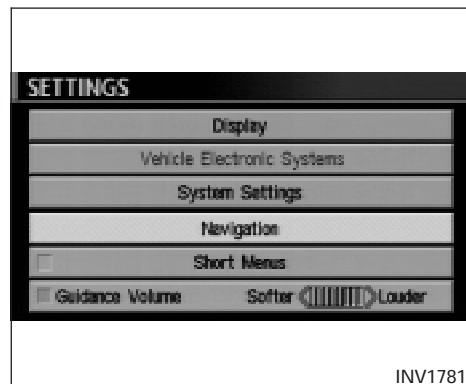

QUICK STOP CUSTOMER SETTING

1. Press the **SETTING** button.
2. Select the **Navigation** key on the [SETTINGS] screen.

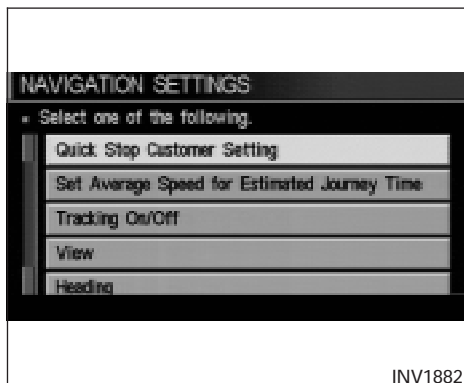

3. Select the

Quick Stop Customer Setting key on the [NAVIGATION SETTINGS] screen.

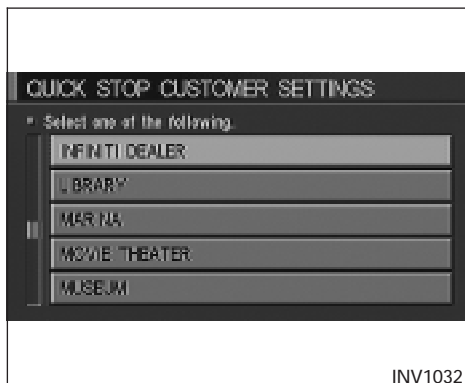

4. Select a facility you frequently visit. For example, select the **INFINITI DEALER** key.

When it is set, the screen returns to the previous screen.

Press the **MAP** button to return to the map.

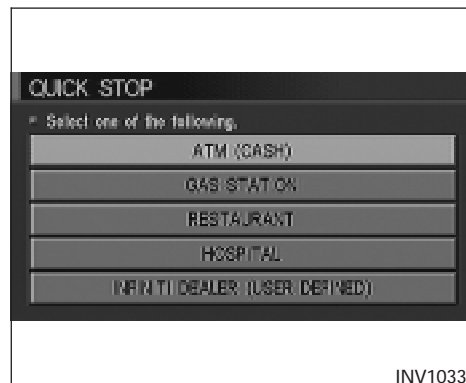

5. Press the **ROUTE** button. Then, select the **Quick Stop** key, and press the ENTER button. The display shows the selected facility in the last row.

WHERE AM I ?

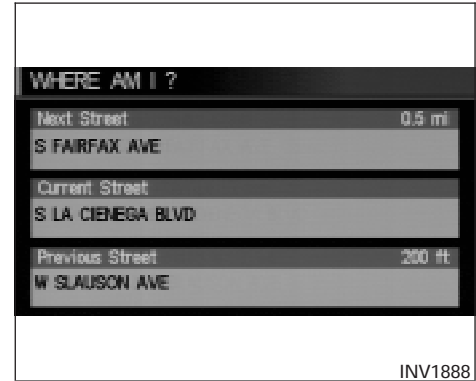
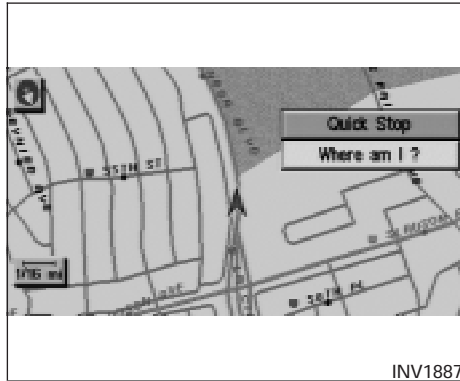

INFO:

When a hospital is set as a destination, a telephone number of the destination will be displayed, if available.

This key is used to find the name of the street on which the vehicle is currently located.

1. Press the **ROUTE** button.

Several keys appear on the right of the screen.

Select the **Where am I ?** key.

2. The display shows the [WHERE AM I ?] screen, which includes the next, current, and previous streets. Each one shows the streets which the vehicle is approaching, currently traveling on, and those streets the vehicle was previously traveling on. Press the **MAP** or **PREV** button to return to the map.

CANCEL GUIDANCE

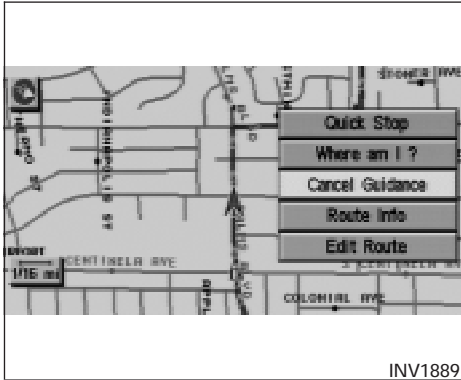

1. Press the **ROUTE** button.
2. Several keys appear on the right of the screen. Select the **Cancel Guidance** key.

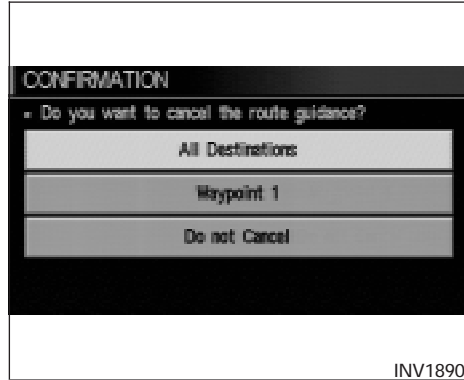

The [CONFIRMATION] screen is displayed with the following three keys.

- All Destinations
- Waypoint 1 or Waypoint
- Do not Cancel

WHEN THE **All Destinations** KEY IS SELECTED

The route guidance is turned off temporarily.

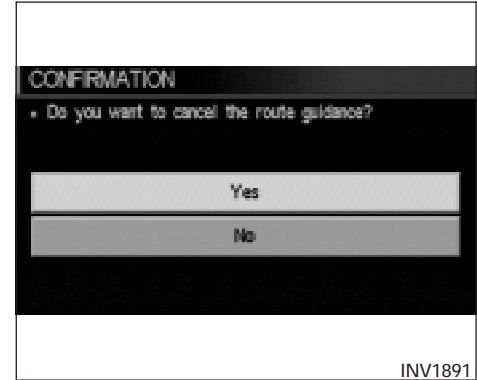

1. Select the **All Destinations** key.
2. When the **Yes** key is selected, the route guidance is turned off.

INFO:

- When the **No** key is selected, the map will be displayed. When the **PREV** button is pressed, the previous screen will be displayed.
- To restart the route guidance, press the **GUIDE VOICE** button.

WHEN THE **Waypoint 1** KEY IS SELECTED

INFO:

This key can be selected only when a waypoint is set.

Route guidance to the next waypoint is deleted.

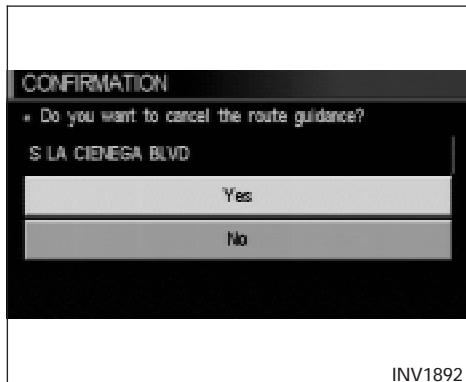

1. Select the **Waypoint 1** key.
2. When the **Yes** key is selected, the waypoint is deleted and route calculation will start.

INFO:

When the **No** key is selected, the map will be displayed. When the **PREV** button is pressed, the previous screen will be displayed.

WHEN THE **Do not Cancel** KEY IS SELECTED

The [CONFIRMATION] screen will return to the map screen.

6 How do I use the Point of Interest (POI) feature?

Setting with the Point of Interest (POI) key.....	6-2
Setting with the List key	6-2
Setting with the Category key	6-5
Setting with the State key.....	6-7

Setting with the City key	6-9
Setting with the Nearby key	6-12
POI categories	6-13
Setting the nearby display icons.....	6-14



SETTING WITH THE

Point of Interest (POI) KEY

The keys in Point of Interest (POI) are:

- List
- Category
- State/Province
- City
- Nearby

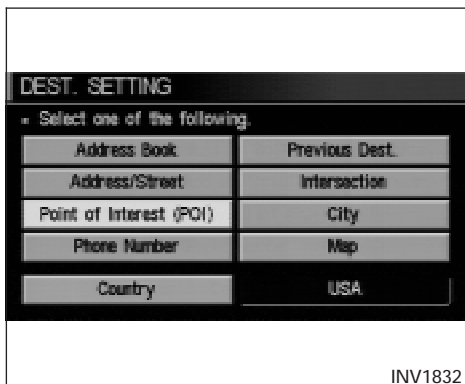

1. First press the **DEST** button.
2. Select the **Point of Interest (POI)** key on the [DEST. SETTING] screen.

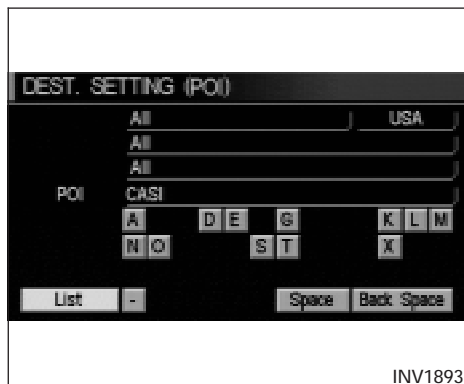

SETTING WITH THE List KEY

The **List** key is used when you know the exact names of the destinations and waypoints.

1. Input the facility name for your destination.

NOTE:

For a quicker search, input the state/province, city and category before searching for your desired destination.

INFO:

If the system detects that the number of corresponding facilities or cities is five or less, the display shows the list screen automatically.



2. The display shows the screen to select a facility or **Info** key.



- When the **Next Search** key is selected, it is possible to narrow down categories, states/provinces and cities. To use this function, refer to "Setting with the **Category** key", "Setting with the **State** key" and "Setting with the **City** key" on pages 6-5, 6-7 and 6-9.

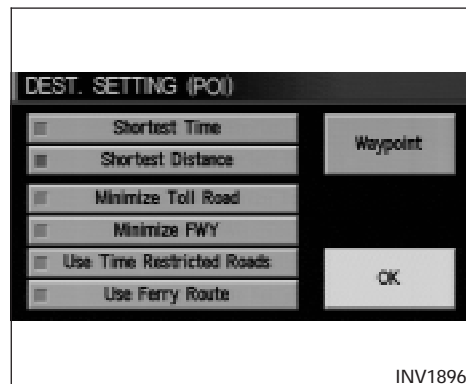

3. When a facility name is selected, the display shows the [DEST. SETTING (POI)] screen to set the destination. Select the **OK** key to enter the priorities selected. Select **Waypoint** to set the closer destination as a waypoint. Please refer to "Making the system guide the route with detailed options" on page 5-31.



- When the **Info** key next to the facility name of your choice is selected in step 2, the display shows the detailed [Address] and [Telephone number] of the selected facility, and the **Map** and **Enter** keys.

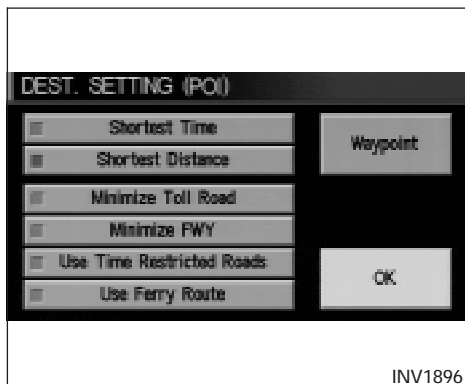

- When setting the facility as the destination, select the **OK** key. The display shows the [DEST. SETTING (POI)] screen to set the destination. Set priorities and select the **Route Calc.** key. Then, the route calculation will be started.

When you alter the destination or set waypoints, select the **Waypoint** key. Please refer to “Making the system guide the route with detailed options” on page 5-31.

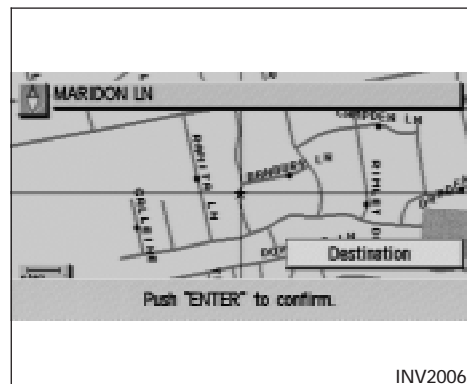

- When the **Map** key is selected, the display shows the map. When the ENTER button is pressed, the display shows the **Destination** key.

6-4 How do I use the Point of Interest (POI) feature?

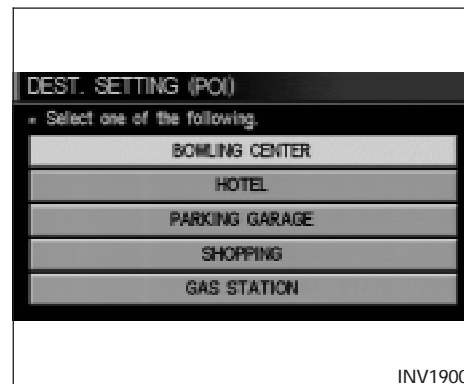
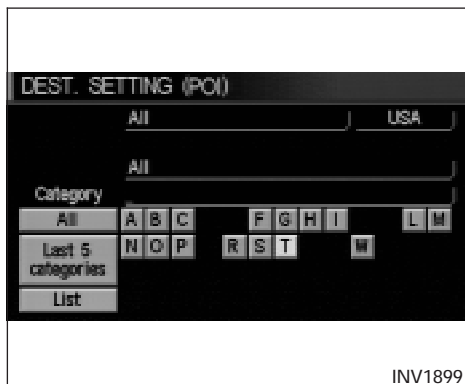
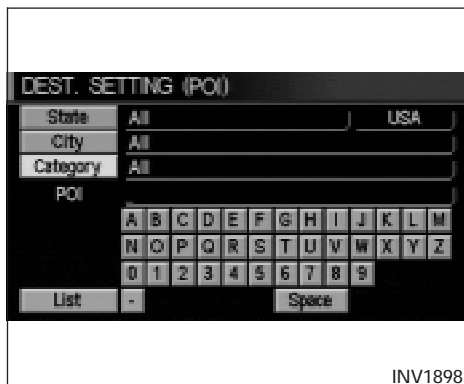

SETTING WITH THE **Category** KEY

The **Category** key is used when you select a facility category to set the destination.

1. Select the **Category** key.

2. The display shows the screen to select categories.

Input a category name. See listing of categories on page 6-13.

- When the **Last 5 Categories** key is selected in step 2, the history of the previous five settings will be listed.

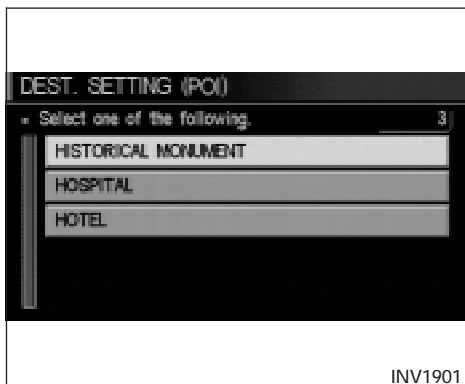

3. The display shows the category list. Select a category name.

INFO:

When the **RESTAURANT** key is selected, the screen to input the cuisine type will be displayed.

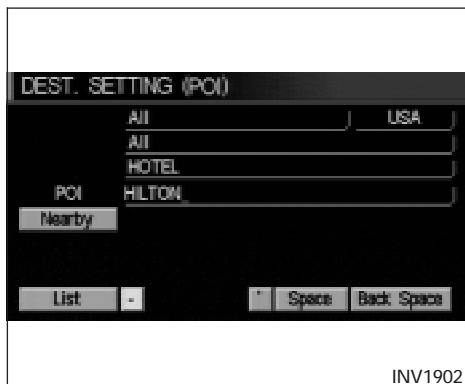

4. The screen returns to the [DEST. SETTING (POI)] screen.

When the category is set, the display shows the selected category beside the **Category** key.

Input the facility name.

INFO:

- If you do not know the facility name you want to go to, select the **List** key so that the facility names in the category will be listed in alphabetical order.

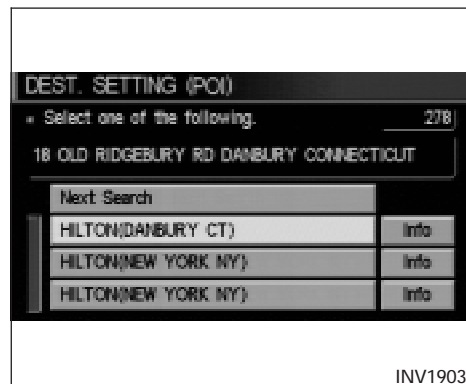

- It may take some time to show the list, depending on categories.

5. When a facility name is input, the system retrieves the facility name according to the selected category and the input letters. Then, the display shows the screen to select a facility and **Info** key. Please refer to “Setting with the **List** key” on page 6-2.

6-6 How do I use the Point of Interest (POI) feature?

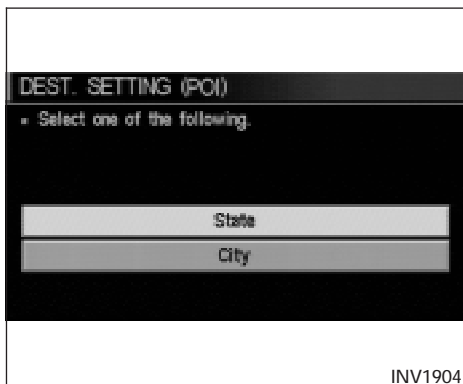

When the **Next Search** key is selected, it is possible to narrow down states/provinces and cities within the selected category. To use this function, refer to “Setting with the **State** key” and “Setting with the **City** key” on pages 6-7 and 6-9.



SETTING WITH THE **State** KEY

The **State** key is used when you select a state/province to set the destination.

1. Select the **State** key.

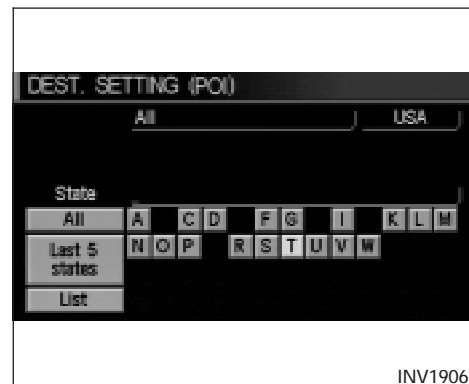

2. The display shows the screen to select states.

Input a state/province name.



When the **Last 5 States** key is selected, the history of the previous five settings will be listed.

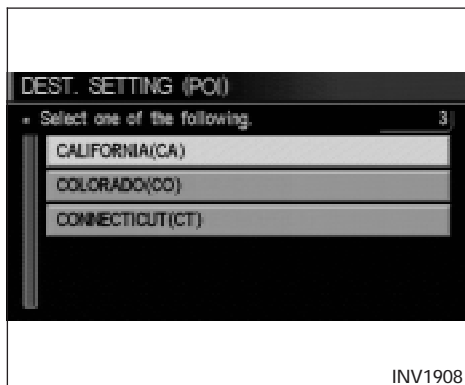

3. The display shows the state list.
Select a state/province name.

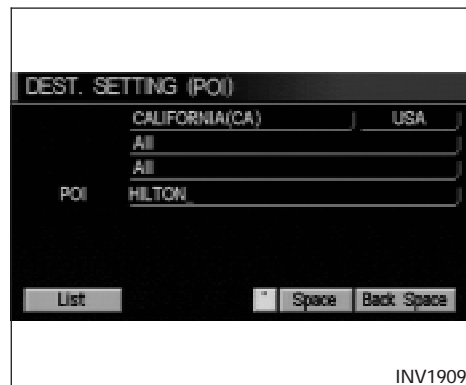

4. The screen returns to the [DEST. SETTING (POI)] screen.

When the state/province is set, the display shows the selected state/province next to the **State** key.

Input the state/province name.

INFO:

If you do not know the facility name you want to go to, select the **List** key so that the facility names will be listed in alphabetical order.

6-8 How do I use the Point of Interest (POI) feature?

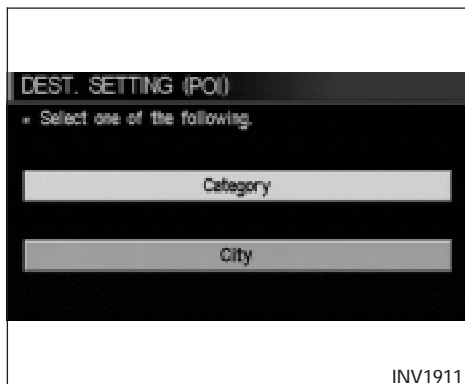
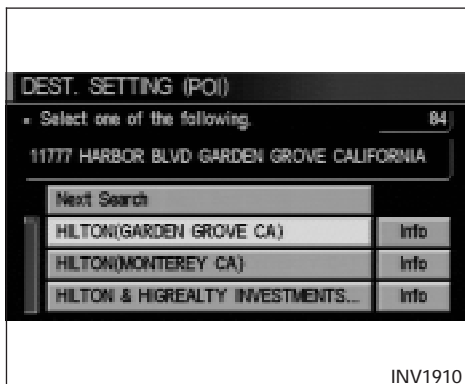

5. When a facility name is input, the system retrieves the facility name according to the input letters. Please refer to “Setting with the **List** key” on page 6-2.

When the **Next Search** key is selected, it is possible to narrow down categories and cities within the selected state. To use this function, refer to “Setting with the **Category** key” and “Setting with the **City** key” on pages 6-5 and 6-9.

SETTING WITH THE **City** KEY

The **City** key is used to retrieve a facility from the specified city to set the destination.

1. Select the **City** key.

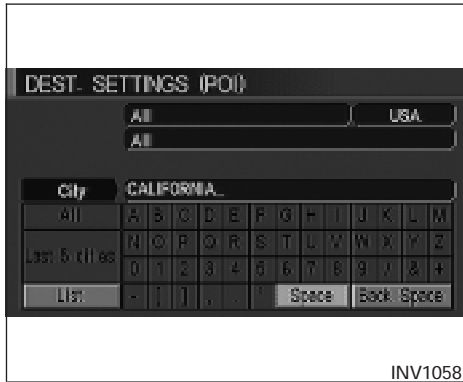

2. The display shows the screen to select cities. Input a city name.



When the **Last 5 Cities** key is selected in step 2, the history of the previous five settings will be listed.

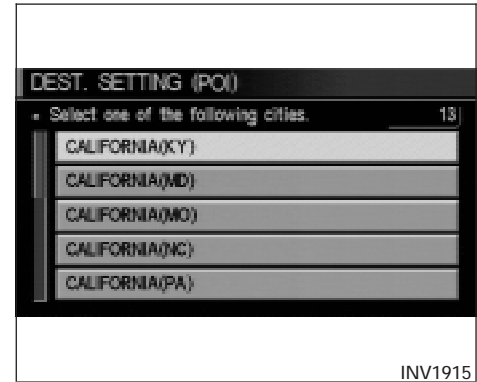

3. The display shows the city list. Select a city of your choice.

6-10 How do I use the Point of Interest (POI) feature?

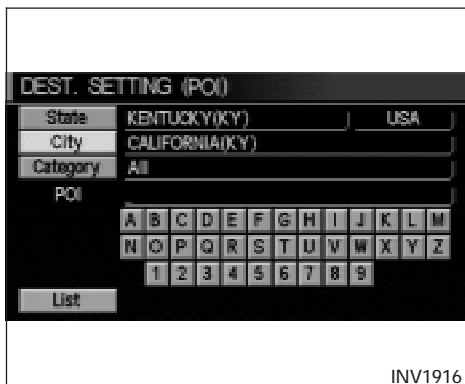

- It may take some time to show the list, depending on categories.

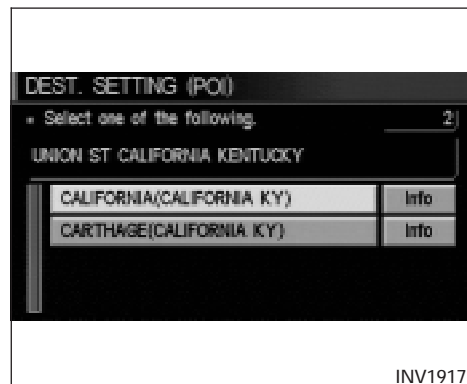

4. The screen returns to the [DEST. SETTING (POI)] screen.

When the city is set, the display shows the selected city beside the [City] key. Input the facility name of your choice.

INFO:

- If you do not know the facility name, select the [Category] key to retrieve a facility. When the facility is set from the [Category] key, the display shows the selected facility beside the [Category] key.

5. When the facility name is input, the system retrieves the facility name according to the selected city and the input letters. Then, the display shows the screen to select a facility and [Info] key.
Please refer to "Setting with the [List] key" on page 6-2.



SETTING WITH THE **Nearby** KEY

The **Nearby** key is used to retrieve a facility within 30 miles (50 km) from the current vehicle location.

1. Select the **Point of Interest (POI)** key on the **[DEST. SETTING (POI)]** screen.
2. Set category according to page 6-5.
3. Select the **Nearby** key.

INFO:

- Facilities in the selected category will be listed from the nearest to the farthest.

6-12 How do I use the Point of Interest (POI) feature?

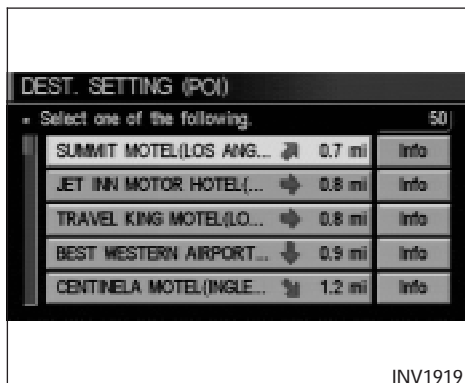

- The **Nearby** key is available only when a category is set. Set a category first.
- When there are any nearby facilities based on the selected category, the display shows the list of facility names, directions and distance from the current vehicle location, and **Info** keys.
Please refer to "Setting with the **List** key" on page 6-2.

POI CATEGORIES

AIRPORT
AMUSEMENT PARK
ATM
AUTO SERVICE & MAINTENANCE
AUTOMOBILE CLUB
BANK
BORDER CROSSING
BOWLING CENTER
BUS STATION
BUSINESS FACILITY
CASINO
CITY CENTER
CITY HALL
COLLEGE AND UNIVERSITY
COMMUNITY CENTER
COMMUTER RAIL STATION
CONVENTION/EXHIBITION CENTER
COURT HOUSE

FERRY TERMINAL
GAS STATION
GOLF COURSE
GROCERY STORE
HISTORICAL MONUMENT
HOSPITAL
HOTEL
ICE SKATING RINK
INFINITI DEALER
LIBRARY
MARINA
MOVIE THEATER
MUSEUM
NIGHTLIFE
NISSAN DEALER
OTHERS
PARK & RIDE
PARK/RECREATION AREA

PARKING GARAGE
PARKING LOT
PERFORMING ARTS
POLICE STATION
RENTAL CAR AGENCY
REST AREA
RESTAURANT
SCHOOL
SHOPPING
SKI RESORT
SPORTS CENTER
SPORTS COMPLEX
TOURIST ATTRACTION
TOURIST INFORMATION
TRAIN STATION
WINERY

SETTING THE NEARBY DISPLAY ICONS

Five types of facilities can be displayed on the map using respective icons, including:

- ATMs
- Gas stations
- Hotels
- Restaurants
- Rest areas

1. Press the **SETTING** button on the control panel.

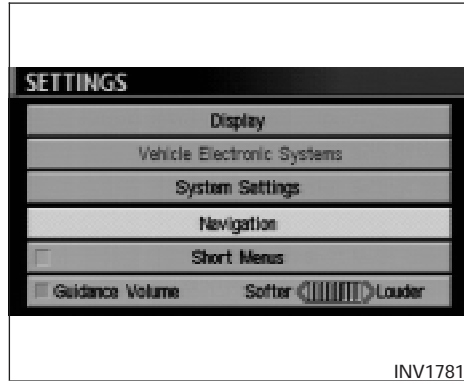

2. Select the **Navigation** key on the [SETTINGS] screen.

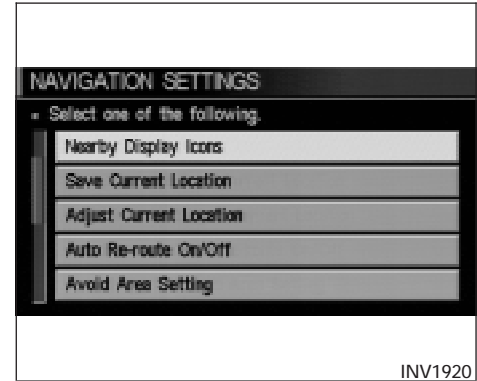

3. Select the **Nearby Display Icons** key on the [NAVIGATION SETTINGS] screen.

The [NEARBY DISPLAY ICONS] screen will be displayed.

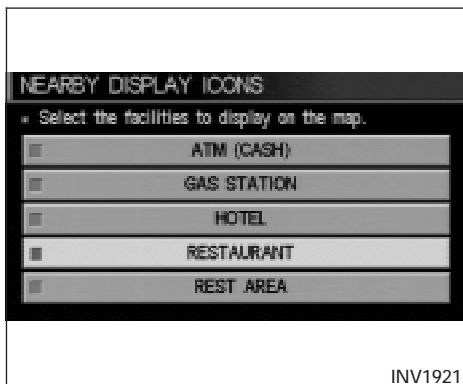

4. Select the facility you wish to display, and press the ENTER button.

INFO:

Every time the ENTER button is pressed, the indicator lights of the items are turned ON and OFF alternately.

ON: To display nearby icons.

OFF: To stop displaying nearby icons.

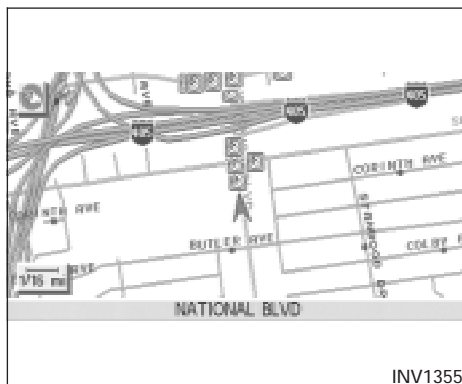

The icons of the selected facilities will be displayed.

INFO:

When the **MAP** button is pressed, the current location will be displayed.

When the **PREV** button is pressed, the previous screen will reappear.

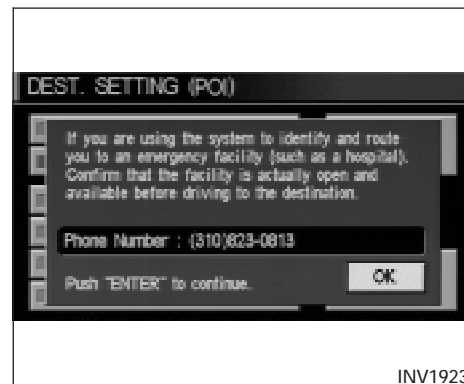

INFO:

When a hospital is set as a destination, a telephone number of the destination will be displayed, if available.

MEMO

7 How do I use the address book feature?

Setting up and editing the address book	7-2	Changing the listing order	7-7
Setting up the address book.....	7-2	Editing the address book	7-8
Using various categories to store locations	7-2	Changing stored names.....	7-8
Storing current vehicle position	7-4	Changing the icons	7-9
Storing locations of your choice	7-5	Adjusting the stored address book entries.....	7-13
Confirming the stored locations	7-5	Deleting stored locations	7-15



SETTING UP AND EDITING THE ADDRESS BOOK

You can store locations in the address book for quicker access, or name the location and set a special icon on the map.

SETTING UP THE ADDRESS BOOK

You can store your favorite places or the places you frequently visit. By storing them, you can recall them quickly on the display, enabling easier setting of these destinations.

USING VARIOUS CATEGORIES TO STORE LOCATIONS

You can choose various categories in the menu to store the locations. The categories are: Address/Street, Points of Interest (POI), Phone Number, Map, Intersection, City and Previous Dest.

1. Press the **SETTING** button.

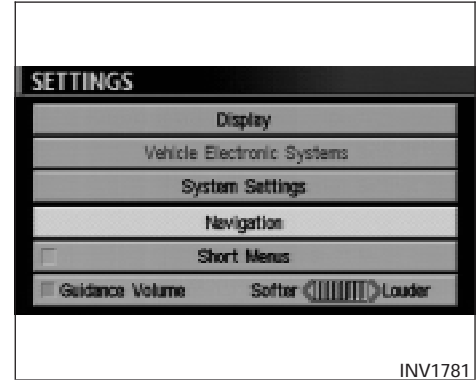

2. Select the **Navigation** key.

The [NAVIGATION SETTINGS] screen will be displayed.

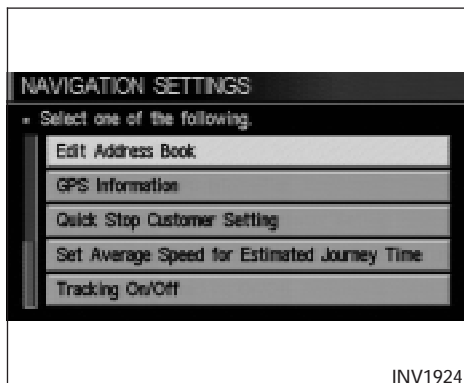

3. Select the Edit Address Book key.

The [EDIT ADDRESS BOOK] screen will be displayed.

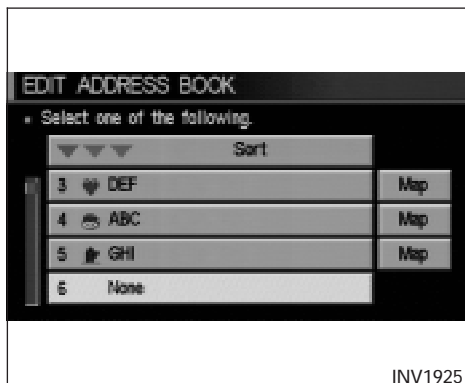

4. Choose an unused number location on the address book list.

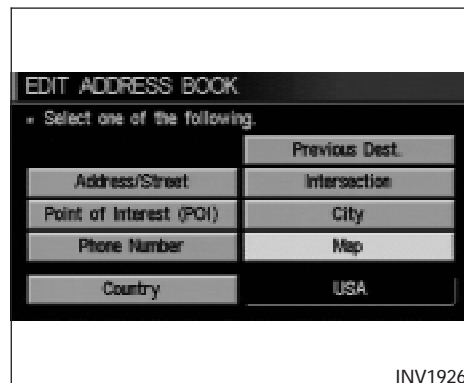

5. Store location.

Set a location to be stored in the same way as when setting a destination (waypoints).

Please refer to “Expert Mode Categories” on page 5-2.

INFO:

- Press the MAP button to go back to get the current vehicle display.
- The maximum number of the stored locations is 50, including your home and office.

- If you want to store places close to POI, it is quicker to use the

Points of Interest (POI) key.

STORING CURRENT VEHICLE POSITION

1. Press the **SETTING** button.

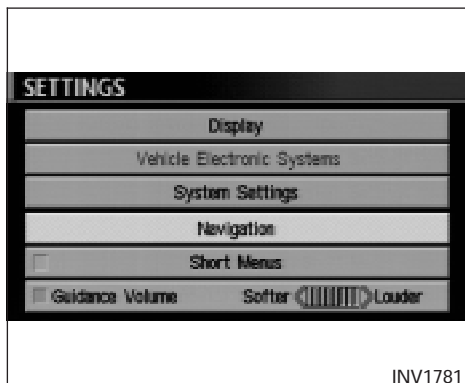

2. Select the **Navigation** key.

The [NAVIGATION SETTINGS] screen will be displayed.

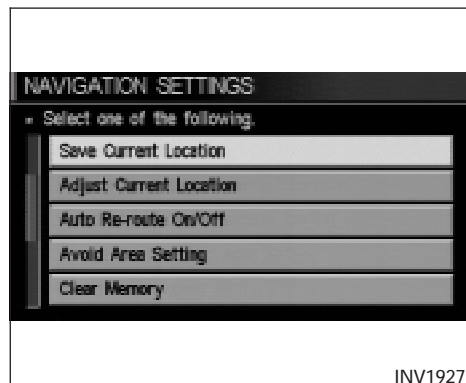

3. Select the **Save Current Location** key.

The current location of the vehicle will be stored in the next available address book location, and be displayed on the vehicle icon screen.

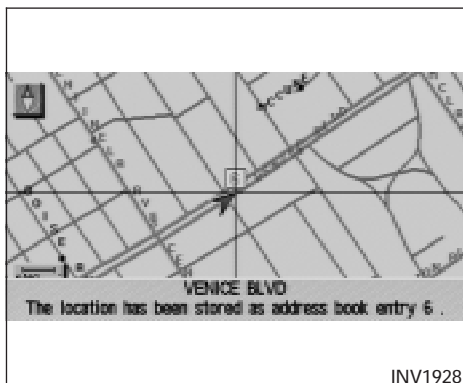

INFO:

- If the number of the stored locations exceeds 50, a message will appear "Memory is full. Delete old one to store new one".
- If you store more than one location at the same place, the location stored in the database with the largest identification number will be displayed.
- If you store the location by the location store function, the stored name may differ, depending on the scale used in the display.
- The unused and smallest identification number will be assigned to the newly set location.

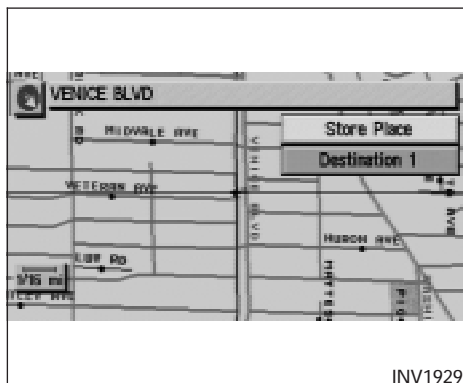

STORING LOCATIONS OF YOUR CHOICE

You can use the joystick to store desired locations.

1. Scroll the map to the desired location with the joystick, then press the ENTER button. The display shows several keys on the right of the screen.
2. Select the key.

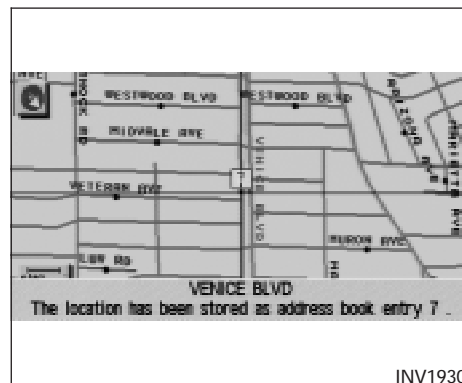

The registered number will be displayed at that location on the map.

INFO:

Press the button once or the button twice to go back to the current vehicle display.

CONFIRMING THE STORED LOCATIONS

To confirm that the locations have been stored:

1. Press the button.

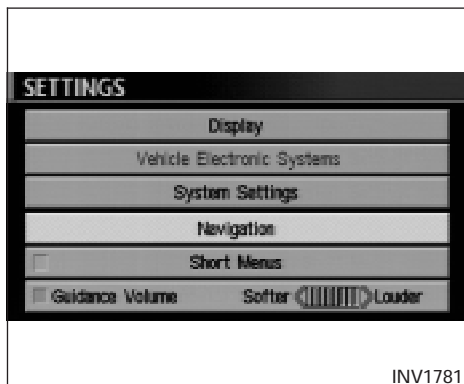

2. Select the **Navigation** key.

The [NAVIGATION SETTINGS] screen will be displayed.

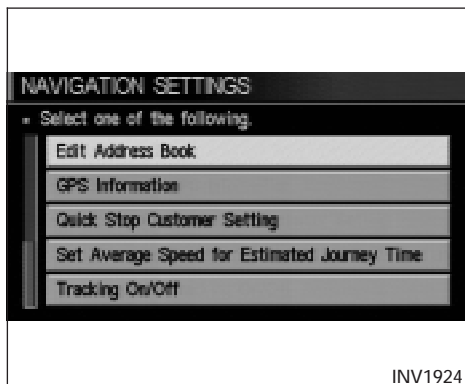

3. Select the **Edit Address Book** key.

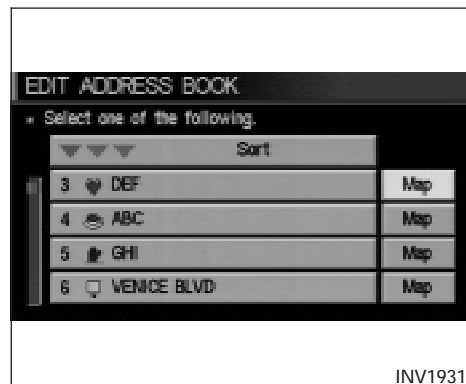

4. Choose the **Map** key next to the location that you want to confirm.

7-6 How do I use the address book feature?

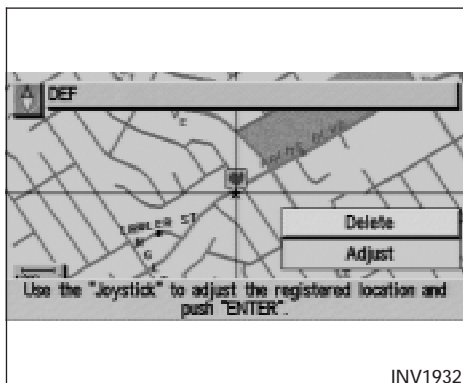

The stored location will be displayed on the map.

INFO:

- If you want to confirm several stored locations, press the **PREV** button.
- To go back to the map display, press the **MAP** button.

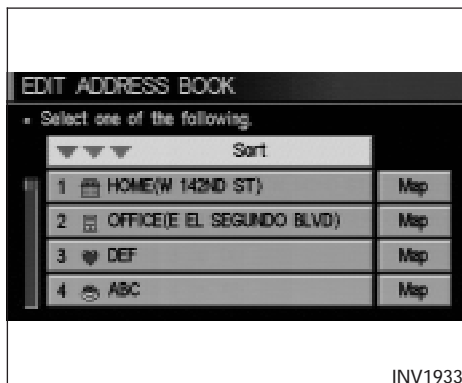

CHANGING THE LISTING ORDER

1. Select the **Sort** key on the [EDIT ADDRESS BOOK] screen.

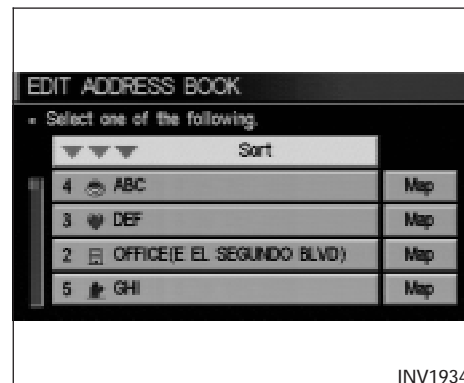

2. To change the listing order, tilt the joystick to the right or left, or press the ENTER button.

When the left indicator on the **Sort** key is highlighted: list in the order of numbers

When the center indicator on the

Sort key is highlighted: list in the order of icons

When the right indicator on the

Sort key is highlighted: list in alphabetical order

EDITING THE ADDRESS BOOK

You can alter the names or the icons of the stored locations.

CHANGING STORED NAMES

1. Press the **SETTING** button.

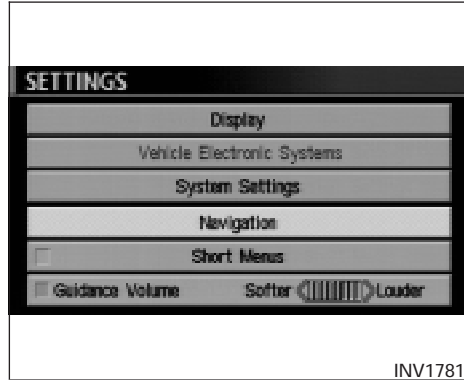

2. Select the **Navigation** key.

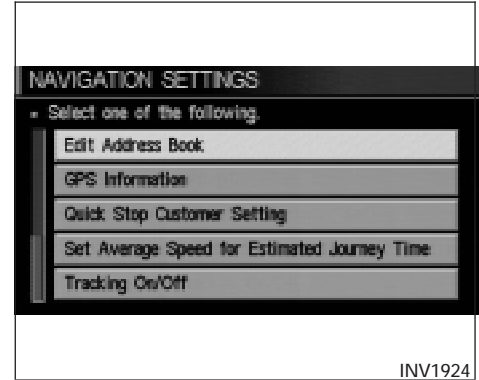

3. Select the **Edit Address Book** key.

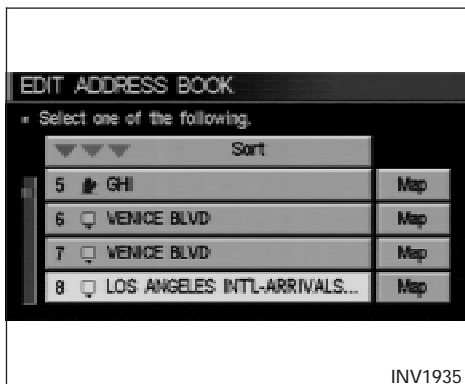

4. Choose the stored location you want to change the name of.

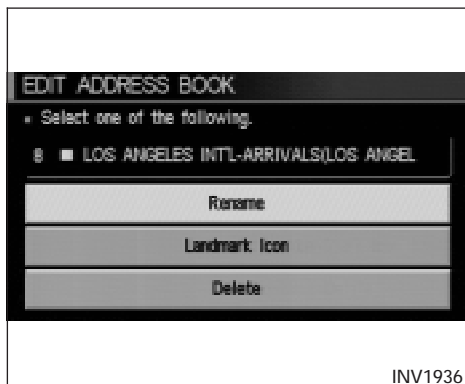

5. Select the **Rename** key.
The change name screen will be displayed.

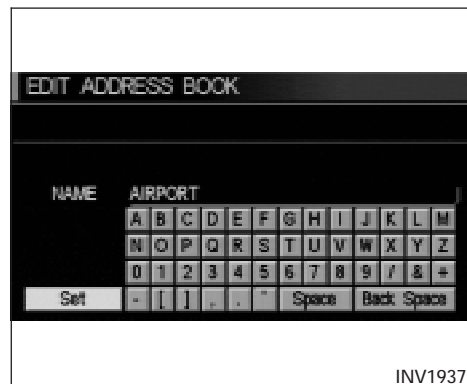

6. Select the **Set** key after entering the new name.

INFO:

To go back to the map display, press the **MAP** button.

CHANGING THE ICONS

1. You can display the icon at a stored location.

Press the **SETTING** button.

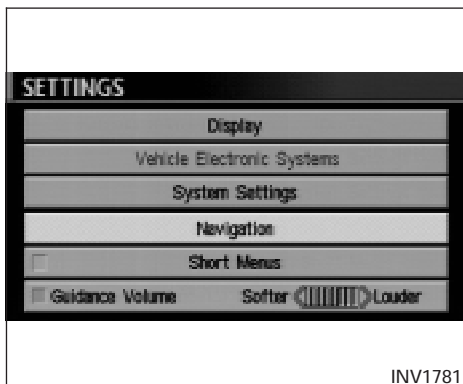

2. Select the **Navigation** key.

The [NAVIGATION SETTINGS] screen will be displayed.

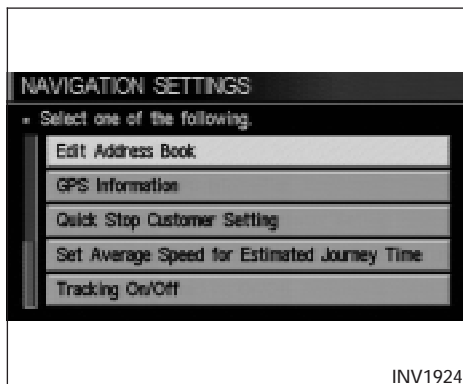

3. Select the **Edit Address Book** key.

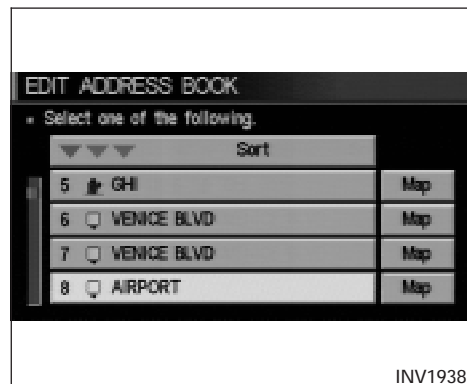

4. Choose a stored location where you want to set the icon.

7-10 How do I use the address book feature?

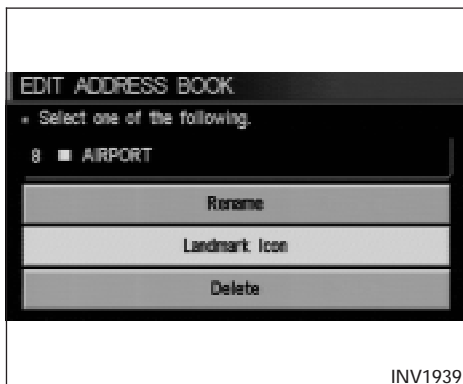

INV1939

5. Select the **Landmark Icon** key.



INV1940

6. Choose an icon. (See the illustration on the next page for a legend of icons which can be set for stored locations.)

The picture displayed on the left [icon] is a plan-view icon and the picture displayed on the right [icon] is a Birdview™ icon.

The icon of the stored location will be set.

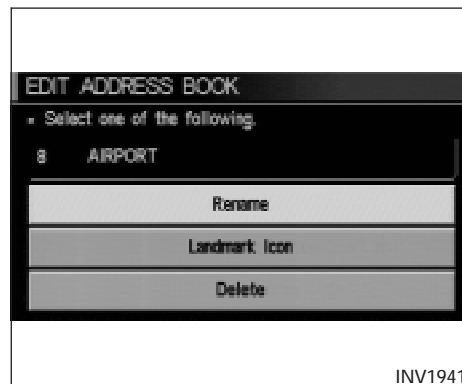

INV1941

INFO:

- To go back to the screen displaying the current vehicle position, press the **MAP** button.
- If you press the **PREV** button, the screen will go back to the screen displayed in step 5.
- If you alter the icon of the stored location, the icon on the map will also change.



INV1755

ADJUSTING THE STORED ADDRESS BOOK ENTRIES

You can easily adjust the point of the stored location with the joystick.

1. Press the **SETTING** button.

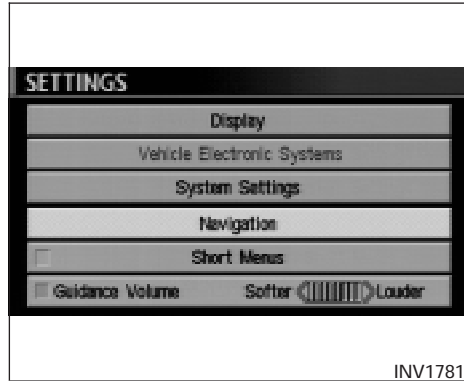

2. Select the **Navigation** key.

The [NAVIGATION SETTINGS] screen will be displayed.

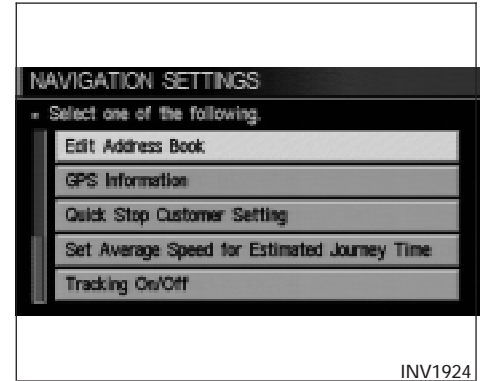

3. Select the **Edit Address Book** key.

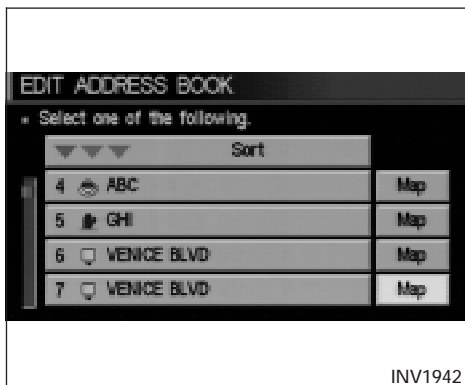

4. Choose the **Map** key next to the stored location you want to adjust.

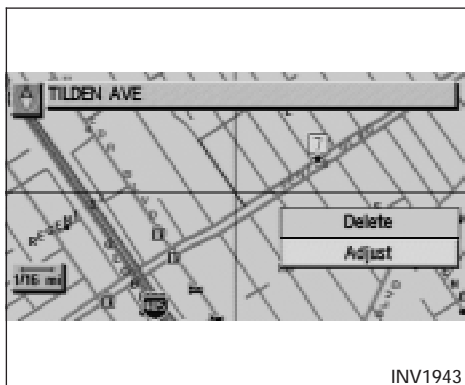

5. Use the joystick to set the new location.

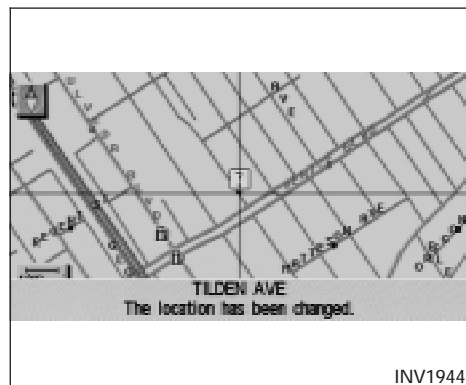

6. Select the **Adjust** key.

The location is updated after the update message is shown. The screen goes back to the screen displaying in step 4.

INFO:

To go back to the screen displaying the current vehicle position, press the **MAP** button.

DELETING STORED LOCATIONS

You can delete the stored locations you no longer need from the system memory.

1. Press the **SETTING** button.

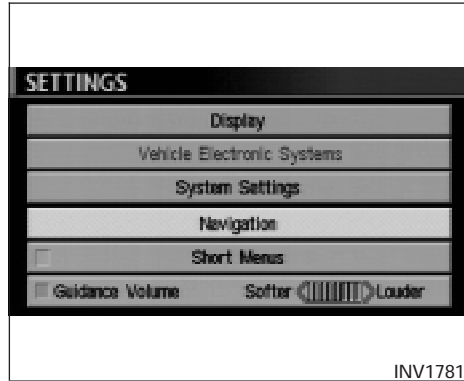

2. Select the **Navigation** key.

The [NAVIGATION SETTINGS] screen will be displayed.

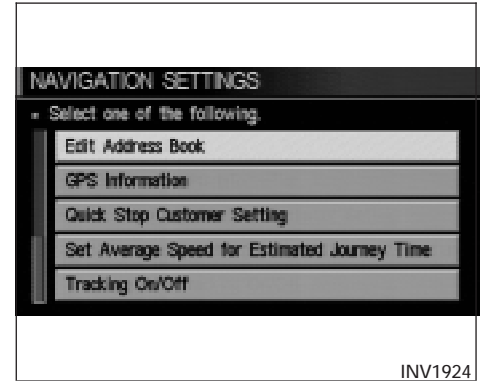

3. Select the **Edit Address Book** key.

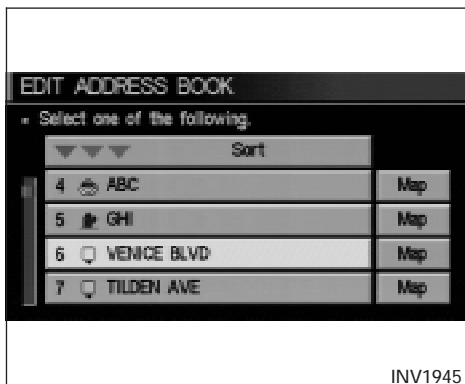

4. Select the location you want to delete.

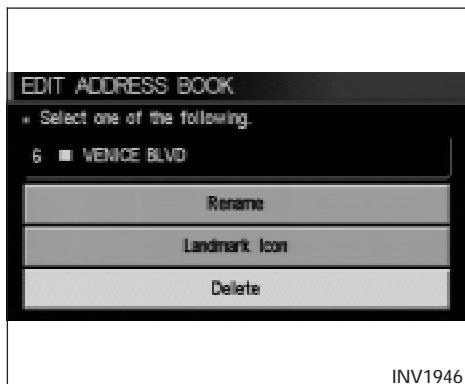

5. Select the **Delete** key.

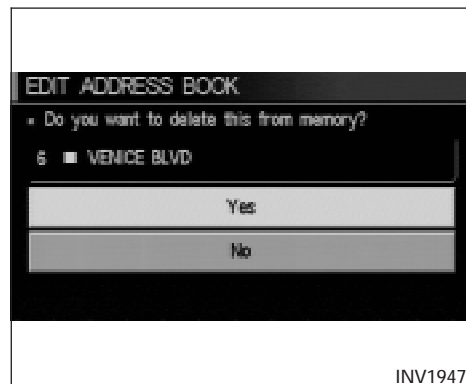

6. The system will ask for a confirmation. If correct, select the **Yes** key. The location will be deleted. After the deletion message is shown, the screen goes back to the screen displayed in step 4.

INFO:

To go back to the screen displaying the current vehicle position, press the **MAP** button.

8 How do I use the avoid area feature?

Setting avoid areas 8-2
Setting with the selected location key 8-5
 Renaming the avoid areas 8-5

Deleting the avoid areas 8-7
Setting with the key 8-8



SETTING AVOID AREAS

Setting “avoid areas” will give you a route away from areas you wish to avoid.

INFO:

If the vehicle icon is in the “avoid area,” route calculation cannot be completed.

1. Press the **SETTING** button.

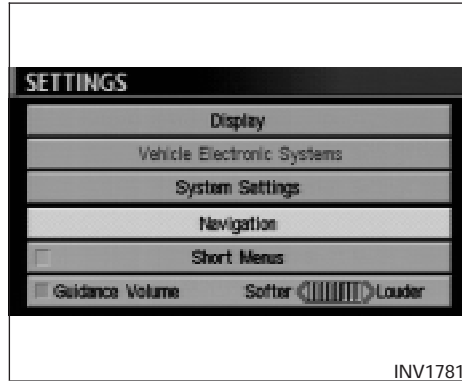

2. Select the **Navigation** key.

The display shows the [NAVIGATION SETTING] screen.

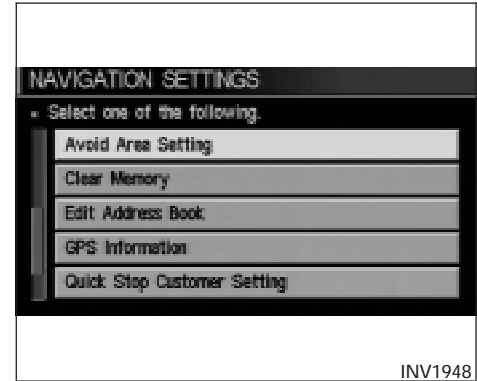

3. Select the **Avoid Area Setting** key.

The display shows the [AVOID AREA SETTING] screen.

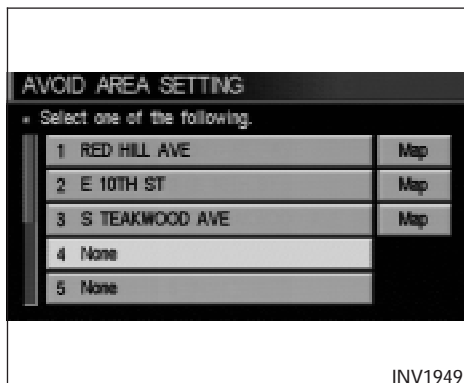

4. Select a key which is not set as an "avoid area."

INFO:

It is possible to set up to 10 areas to avoid.

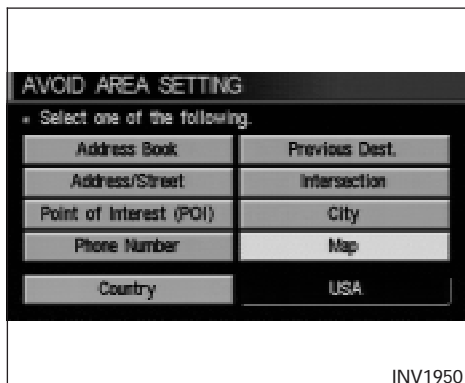

5. The display shows categories which can be used to set an "avoid area."

For example, use the **Map** key to set an "avoid area."

Select the **Map** key.

INFO:

For setting with other categories, please refer to "Expert mode categories" on page 5-2.

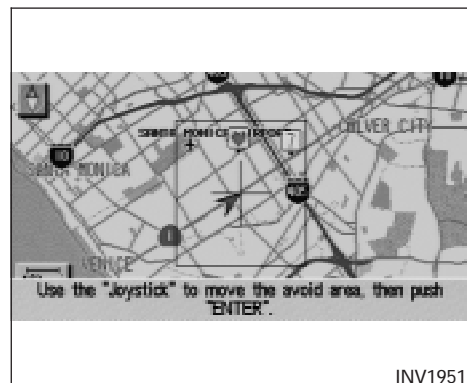

6. The display shows the map which centers the area to be set as an "avoid area."

Use the **+** (**ZOOM IN**) or **-** (**ZOOM OUT**) button to adjust the map reduction scale.

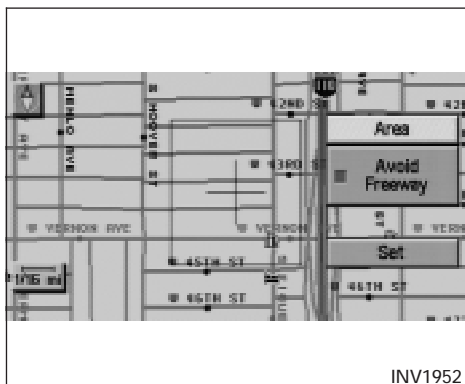

7. Use the joystick to adjust the location.

INFO:

Area size: Max. 5 x 5miles (8 x 8 km)

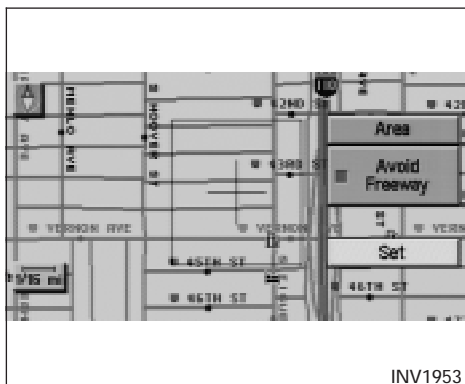

8. The display shows the keys on the right of the screen.

Select the key.

INFO:

- If you want to avoid the freeway in that area, select the key to turn on the amber indicator on the key. (Indicator ON: avoid, OFF: do not avoid)
- When altering the size of the "avoid area," select the key. The area size is increased or decreased by three scales.

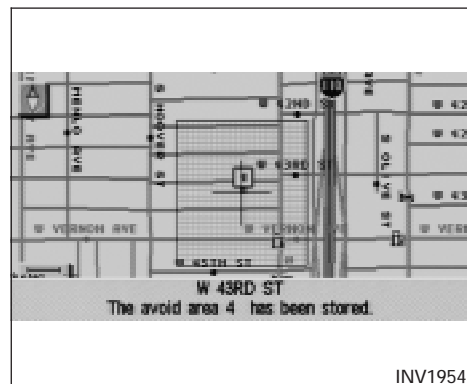

9. The "avoid area" is set, and the grid will be displayed on the screen.

INFO:

The grid color will be displayed in green or blue.

(Avoid Freeway ON: green, OFF: blue)

If the route guidance is set, the display shows the [AVOID AREA SETTING] screen.

8-4 How do I use the avoid area feature?

SETTING WITH THE SELECTED LOCATION KEY

When the stored “avoid area” is selected, it can be renamed or deleted.

RENAMING THE AVOID AREAS

1. Press the **SETTING** button.

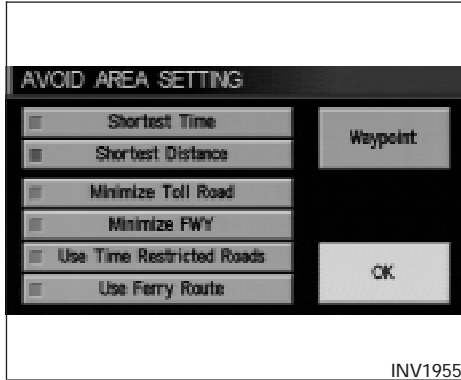

10. Please refer to “Making the system guide the route with detailed options” on page 5-31.

If the route guidance is not set, the display shows the current vehicle location.

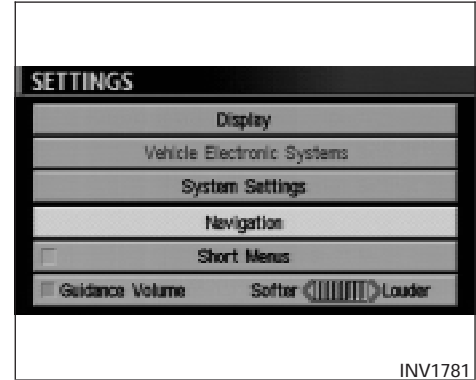

2. Select the **Navigation** key.

The display shows the [NAVIGATION SETTINGS] screen.

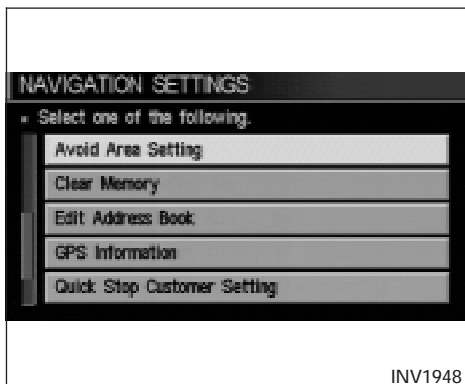

3. Select the key.

The display shows the [AVOID AREA SETTING] screen.

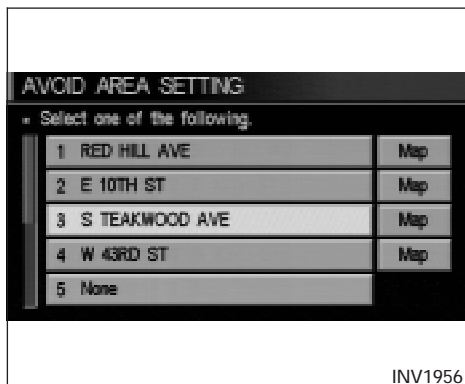

4. Select a key which is set as an “avoid area.”

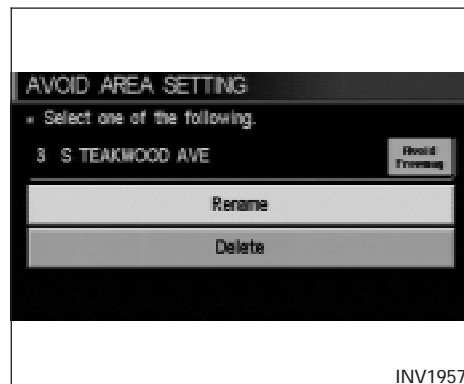

5. Select the key.

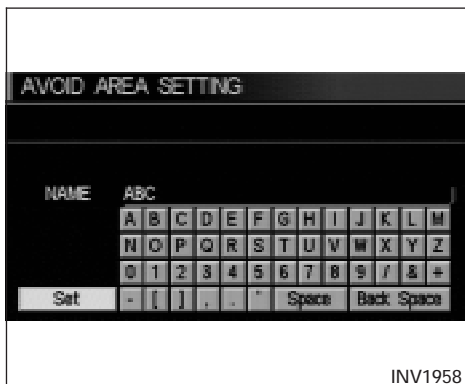

6. The display shows the keyboard.

Enter the area name using the keyboard.

When the **Set** key is selected, the “avoid area” is renamed, and the screen returns to the previous screen.

INFO:

When the **Back Space** key is selected, the cursor moves back to the previous letter. When the

Space key is selected, the cursor proceeds to make one space.

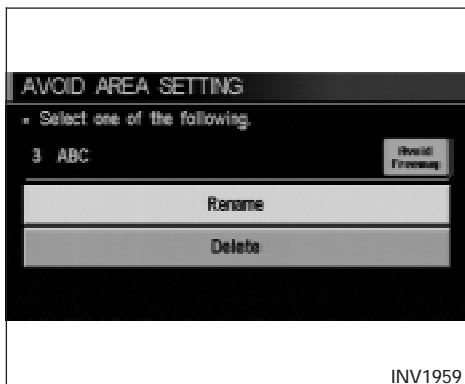

DELETING THE AVOID AREAS

1. Select the **Delete** key on the screen in step 5 under “Renaming the avoid areas”.

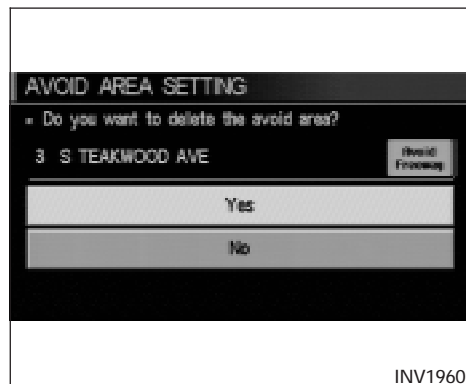

2. Select the **Yes** key.

The “avoid area” is deleted.

If the route guidance is set, the display shows the [AVOID AREA SETTING] screen.

INFO:

When the **No** key is selected, the “avoid area” will not be deleted, and the screen returns to the previous screen.

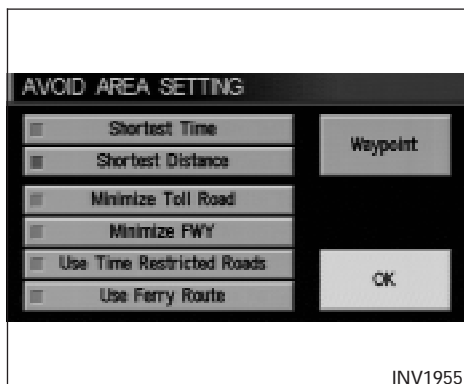

3. Please refer to “Making the system guide the route with detailed options” on page 5-31.

If the route guidance is not set, the display shows the current vehicle location.

SETTING WITH THE Map KEY

When the stored “avoid area” is selected, it can be adjusted or deleted.

Press the SETTING button.

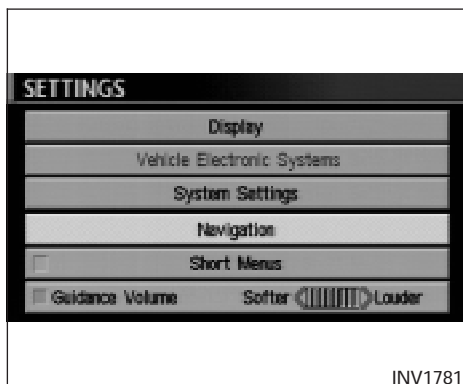

Adjusting the stored avoid areas

1. Select the Navigation key.

The display shows the [NAVIGATION SETTINGS] screen.

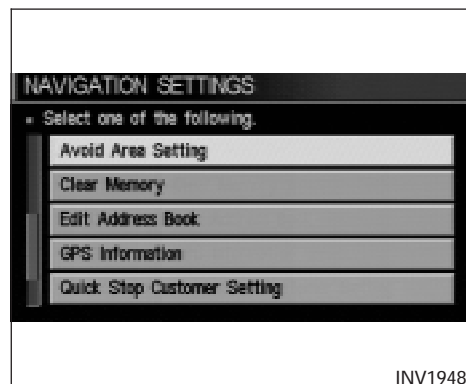

2. Select the Avoid Area Setting key.

The display shows the [AVOID AREA SETTING] screen.

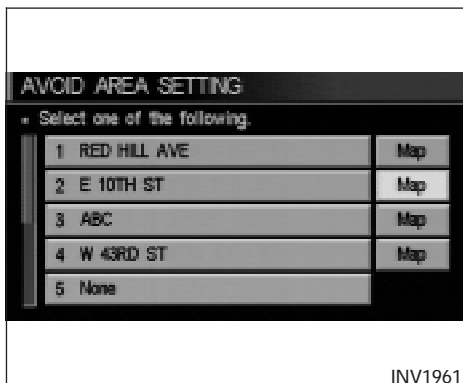

INV1961

3. Select the key of stored “avoid areas.”

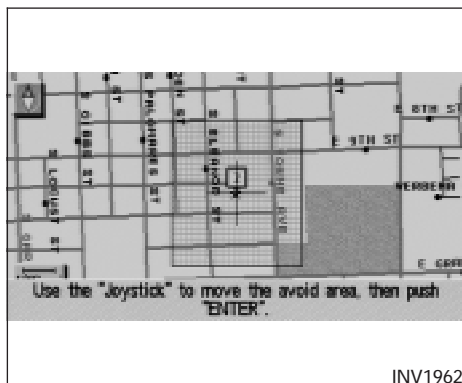

INV1962

4. Use the joystick to adjust the location.

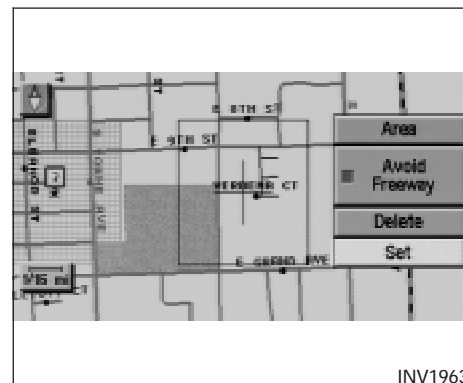

INV1963

5. Press the ENTER button.

The display shows the keys on the right of the screen.

Select the key.

INFO:

- If you want to avoid the freeway in that area, select the key to turn on the amber indicator on the key. (Indicator ON: avoid, OFF: do not avoid)
- When altering the size of “avoid area,” select the key. The area size is increased or decreased by three scales.

How do I use the avoid area feature? 8-9

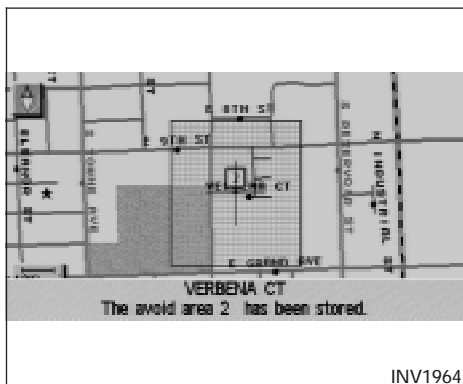

INV1964

- The “avoid area” is set, and the grid is displayed on the screen.

If the route guidance is set, the display shows the [AVOID AREA SETTING] screen.

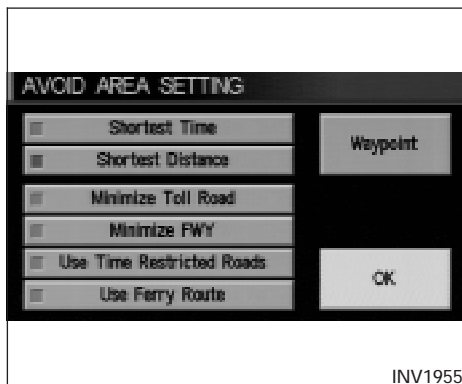

INV1955

- Please refer to “Making the system guide the route with detailed options” on page 5-31.

If the route guidance is not set, the display shows the current vehicle location.

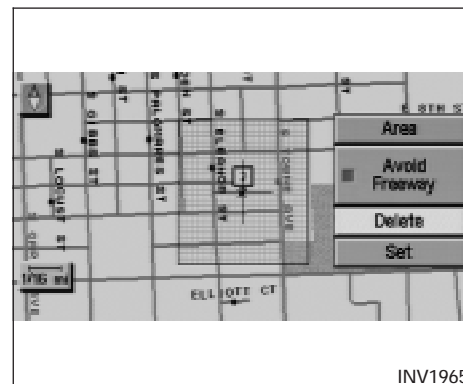

INV1965

Deleting the stored avoid areas

- Select the **Delete** key on the screen shown in step 5 under “Adjusting the stored avoid areas”.

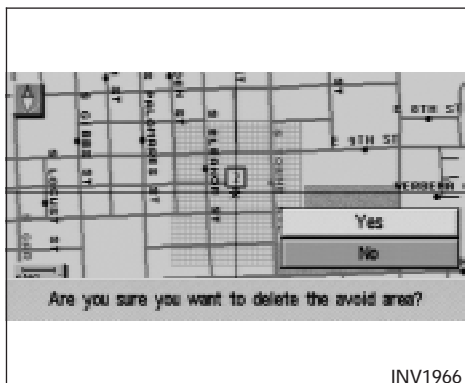

2. Select the key when asked if you are sure you want to delete the “avoid area.”

The “avoid area” is deleted.

If the route guidance is set, the display shows the [AVOID AREA SETTING] screen.

INFO:

When the key is selected, the “avoid area” will not be deleted, and the screen returns to the previous one.

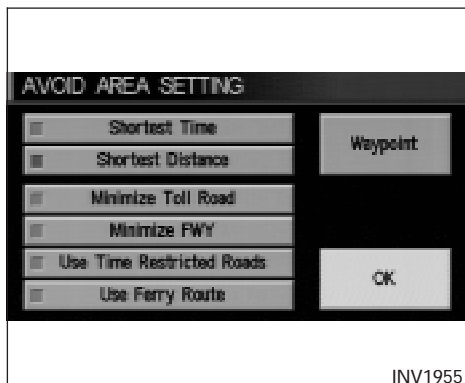

3. Please refer to “Making the system guide the route with detailed options” on page 5-31.

If the route guidance is not set, the display shows the current vehicle location.

MEMO

8-12 How do I use the avoid area feature?

9 How do I use the automatic re-routing feature?

Re-routing when the vehicle is off the suggested route 9-2
 Automatic re-routing 9-2

Detouring from the route temporarily 9-3



RE-ROUTING WHEN THE VEHICLE IS OFF THE SUGGESTED ROUTE

When you have strayed from the suggested route during the route guidance, you can request a re-route from the current location using the automatic re-routing function.

AUTOMATIC RE-ROUTING

This setting will re-route the vehicle automatically when the driver deviates from the suggested road. You will have to set the system for automatic re-routing to enable this function.

1. Press the **SETTING** button.

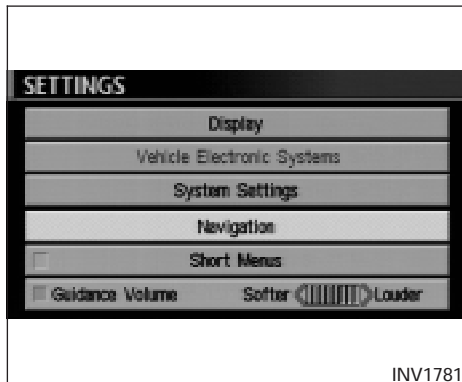

2. Select the **Navigation** key.

The display shows the [NAVIGATION SETTINGS] screen.

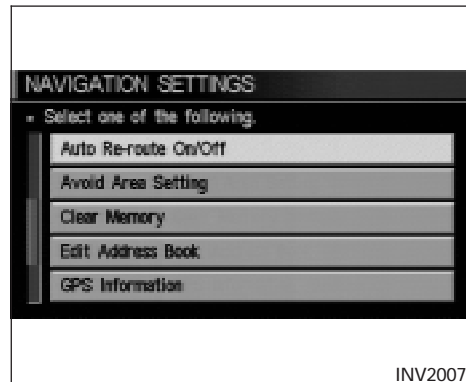

3. Select the **Auto Re-route On/Off** key.

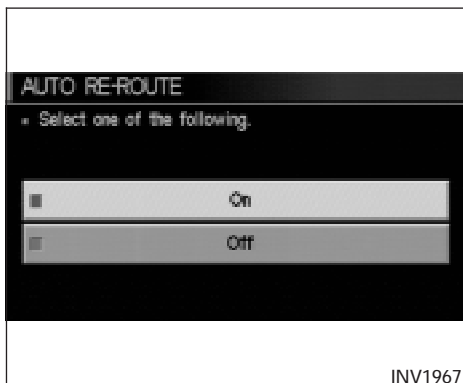

4. When turning on/off the auto re-route, select the **On** or **Off** key.

When the **ENTER** button is pressed, the selected key will be illuminated.

5. Press the **MAP** button.

The map screen will reappear, and the system will start route calculation automatically.

INFO:

- When optional routes are not found, the original route will be displayed.
- When the vehicle runs off the suggested route with the automatic re-routing function

activated, route re-calculation will be attempted so that the vehicle returns to the original route. However, if the vehicle stays off the route, the system will calculate a new route.

DETOURING FROM THE ROUTE TEMPORARILY

If you encounter a traffic jam, you can ask the system to calculate a detour with the pre-set distance.

NOTE:

The detour feature is only available when a destination has been set.

1. Press the **ROUTE** button.

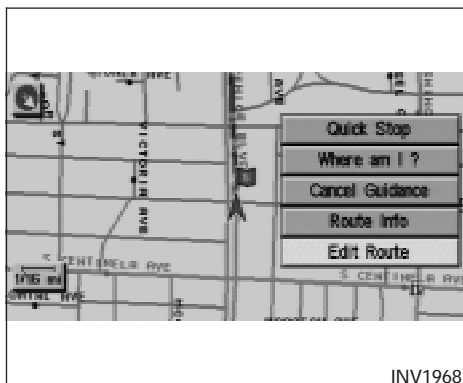

2. Select the **Edit Route** key.

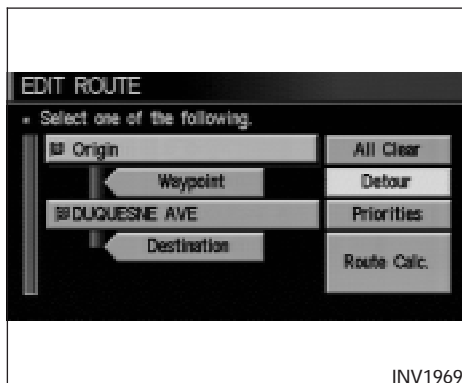

3. Select the **Detour** key.

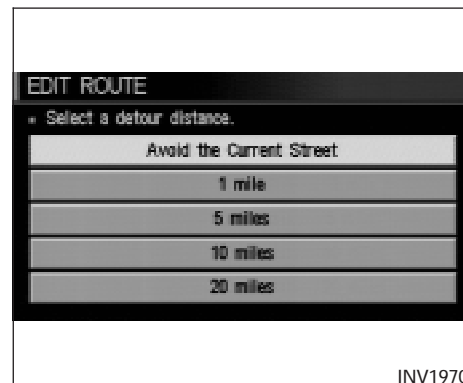

4. Set distance for detour calculation. The system will look for a detour according to the distance set from the current location.

INFO:

- When the **Avoid the Current Street** key is selected, a detour route to approximately 20 miles (30 km) will be calculated if the distance to the next guide point intersection exceeds 20 miles (30 km).
- If an alternative route cannot be found, the previous route before calculation will be displayed.
- If the vehicle is traveling at high speed, the suggested detour may start from a point the vehicle has already passed.

9-4 How do I use the automatic re-routing feature?

10 How do I use the voice guidance feature?

About voice guidance	10-2	Notification of consecutive intersections on an ordinary road	10-3
Basics of voice guidance	10-2	Notification of an entrance to a freeway	10-3
Adjusting the guide volume	10-2	Notification of a freeway junction	10-3
Directions given and the distance to the road points	10-2	Notification of an exit from a freeway	10-3
Notification of an intersection on an ordinary road	10-3	Requesting current voice information	10-3
		Notes on the voice guidance	10-4



ABOUT VOICE GUIDANCE

WARNING

To operate the navigation system or to use the screen functions, first park the vehicle in a safe place and set the parking brake. Using the system while driving can distract the driver and may result in a serious accident.

BASICS OF VOICE GUIDANCE

The voice guidance will verbally tell you which direction to turn when the vehicle approaches the intersection in which you have to make a turn to reach your destination.

NOTE:

Directional guidance provided by the navigation system does not take carpool lane driving into consideration, especially when carpool lanes are separated from other road lanes.

- There may be some cases in which the voice guidance and the actual road conditions do not correspond. This may occur because of discrepancies between the actual road and the information on the DVD or due to the vehicle's speed.
- In case the content of the voice guidance does not match the actual road

10-2 How do I use the voice guidance feature?

conditions, follow the information obtained from traffic signs or notices on the road.

ADJUSTING THE GUIDE VOLUME

1. Press the **SETTING** button on the control panel.

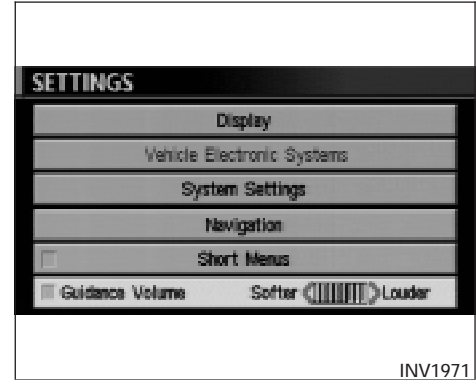

2. Select the **Guidance Volume** key, then push the **ENTER** button. When the **Guidance Volume** key is illuminated with amber indicator, it is activated. When turning up/down the voice guidance, touch the **Louder** or **Softer** key. The voice will become louder/softer.

DIRECTIONS GIVEN AND THE DISTANCE TO THE ROAD POINTS

Directions will differ depending on road type.

INFO:

Distances may vary depending on vehicle speed.

NOTIFICATION OF AN INTERSECTION ON AN ORDINARY ROAD

"In a quarter mile (400 meters), right (left) turn."

"Right (left) turn ahead."

NOTIFICATION OF CONSECUTIVE INTERSECTIONS ON AN ORDINARY ROAD

"In a quarter mile (400 meters), right (left) turn, then left (right) turn."

"Right (left) turn ahead, then left (right) turn."

NOTIFICATION OF AN ENTRANCE TO A FREEWAY

"In a quarter mile (400 meters) freeway entrance on your right onto (road number and direction)."

"Freeway entrance on your right onto (road number and direction)."

NOTIFICATION OF A FREEWAY JUNCTION

"In about one mile (1.6 kilometers), keep to the right (left) onto (road number and direction), then in a quarter mile keep to the left (right)."

"Keep to the right (left) onto (road number and direction), then in a quarter mile (400 meters) keep to the left (right) onto (road number and direction)."

"Keep to the left (right) onto (road number and direction)."

NOTIFICATION OF AN EXIT FROM A FREEWAY

"In about one mile (1.6 kilometers), exit on your right."

"Take the second exit on your right."

REQUESTING CURRENT VOICE INFORMATION

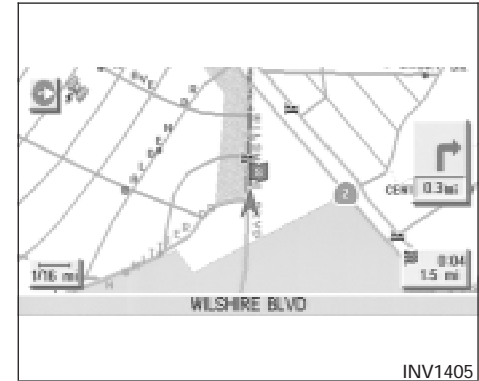

This is available during route guidance, from the time after the route calculation is completed until the vehicle arrives at the destination.

Press the **GUIDE VOICE** button.

The current condition will be announced.

INFO:

- If you press the **GUIDE VOICE** button when you are off the suggested route and when the automatic re-route function is off, the voice will announce: "Proceed to the highlighted route."
- If you press the **GUIDE VOICE** button when you are going in the wrong direction, the voice will announce: "Please make a legal U-turn if possible."

NOTES ON THE VOICE GUIDANCE

- The voice guidance in this system should be regarded as a supplementary function. When driving your vehicle, check the route on the map display and follow the actual road and all traffic regulations.
- The voice guidance is activated only for junctions with certain conditions. In some cases you may need to turn, even if there is no voice guidance.
- The content of the voice guidance may vary, depending on the direction of the turn and the type of junction with other roads.
- The route guidance will be activated at various times depending on the situation.
- When the vehicle is off the suggested route, route guidance is not available. The system will not inform you of this; please refer to the map display and request rerouting.
- At freeway junctions, the road numbers and directions may not accurately correspond with the voice guidance.
- At freeway exits, the street names may not accurately correspond with the voice guidance.
- The displayed street names may sometimes differ from the actual names or "UNKNOWN STREET NAME" may be displayed.
- When the amber indicator on the Guide Volume key is not illuminated, the voice guidance is not available.
- The voice guidance will start when the vehicle enters the suggested route. Before entering the route, refer to the map display for the direction.
- When the vehicle approaches a waypoint, the voice will say, "You have arrived at waypoint 1 (2, 3, 4...)." The guidance will switch to the next route section. While the voice guidance is not available, please refer to the map display for the direction.
- When the vehicle approaches a destination, the voice will say, "You have arrived at your destination. Ending route guidance." For the remainder of the way, please find your direction on the map display.
- In some cases, the voice guidance ends before arrival at the destination. In such cases, drive the vehicle by referring to the destination icon displayed on the map screen.
- When the system can judge on which side the destination (waypoint) is located, the voice guidance will say "on the right (left)" after announcing the arrival at the destination.
- Voice guidance may not operate as specified or may not operate at all due to the angle of roads at intersection entrances and exits.

Please refer to "Automatic re-routing" on 9-2.

10-4 How do I use the voice guidance feature?

11 How do I adjust the display?

Screen information — Plan View display.....	11-2	Displaying the track.....	11-15
Screen information — Birdview™ display	11-2	GPS information display.....	11-17
Switching between Birdview™ and Plan		Updating the current vehicle location and the	
View displays	11-3	direction.....	11-18
Zooming in and out of the map.....	11-6	Setting the display mode	11-20
Changing the display direction		Adjusting the display brightness.....	11-20
(in Plan View display)	11-7	Adjusting the display contrast.....	11-21
Scrolling the map.....	11-9	Switching the display color	11-22
Displaying the complete route to the destination	11-10	How to handle the display	11-24
Displaying turn list	11-11	Characteristics of liquid crystal display.....	11-24
Requesting the simulation drive to the destination	11-13	Maintenance of the display	11-24
Cancel simulation	11-14		



SCREEN INFORMATION — PLAN VIEW DISPLAY

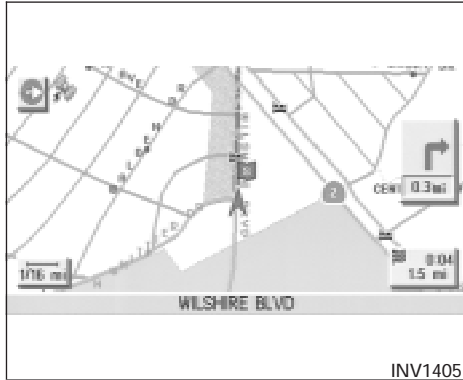

Direction key:

This indicates and sets the direction of the map on the display.

Please refer to “Changing the display direction (in Plan View display)” on page 11-7.

Map scale:

This display indicates the scale on the current map.

Vehicle icon:

This icon indicates your vehicle and the direction of travel.

GPS indicator:

This will tell you the strength of the GPS signal received.

Please refer to “Accuracy of positioning” on page 2-2.

Distance indicator:

This will indicate the approximate distance of route and traveling time to the destination. This indicator will appear when you set the destination with the route guidance ON.

MAP/PREV button:

Press the **MAP** or **PREV** button to show the enlarged intersection display.

SCREEN INFORMATION — Birdview™ DISPLAY

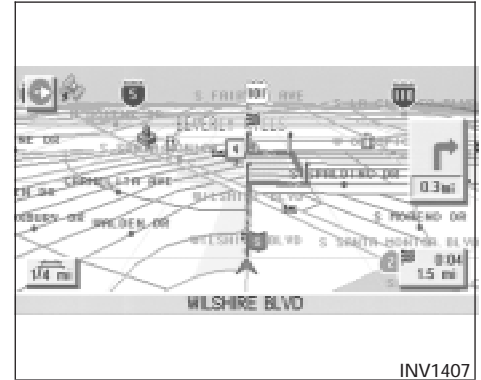

Map scale:

This display indicates the scale on the current map.

By using the  (**ZOOM IN**) /  (**ZOOM OUT**) buttons, you can change the scale of the map.

Height and distance on Birdview™ display is shown in the following table.

Height of view	Distance between grids	Depth of distance
512,000 feet (160,000 m)	160 miles (256 km)	approx. 2,240 miles (approx. 1,792 km)
128,000 feet (40,000 m)	40 miles (64 km)	approx. 560 miles (approx. 896 km)
64,000 feet (20,000 m)	20 miles (32 km)	approx. 280 miles (approx. 448 km)
32,000 feet (10,000 m)	10 miles (16 km)	approx. 140 miles (approx. 224 km)
16,000 feet (4,800 m)	4.0 miles (8 km)	approx. 70 miles (approx. 112 km)
8,000 feet (2,400 m)	2.0 miles (4 km)	approx. 35 miles (approx. 56 km)
4,000 feet (1,200 m)	1.0 mile (2 km)	approx. 17-1/2 miles (approx. 28 km)
2,000 feet (600 m)	1/2 mile (1 km)	approx. 8-3/4 miles (approx. 14 km)
1,000 feet (300 m)	1/4 mile (500 m)	approx. 4-3/8 miles (approx. 7 km)

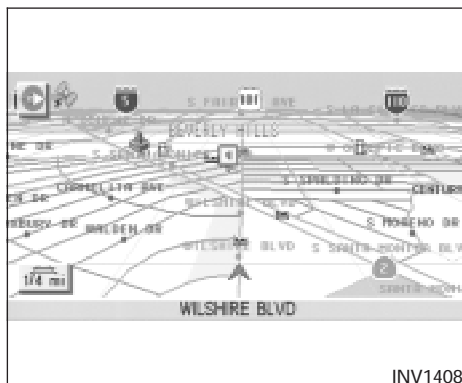

Height of view: 1,000 feet (300 m)

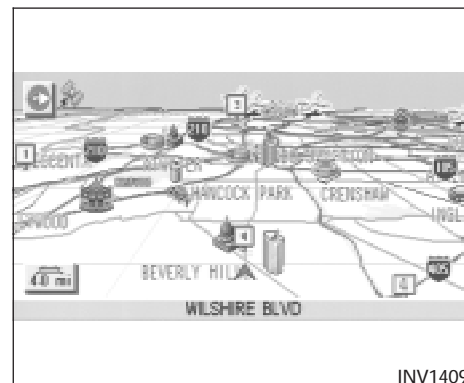

Height of view: 16,000 feet (4,800 m)

SWITCHING BETWEEN Birdview™ AND PLAN VIEW DISPLAYS

Birdview™ mode displays the view from above, looking down toward the direction the vehicle is traveling. This combines the detailed display close to the vehicle and the long distance view in one screen.

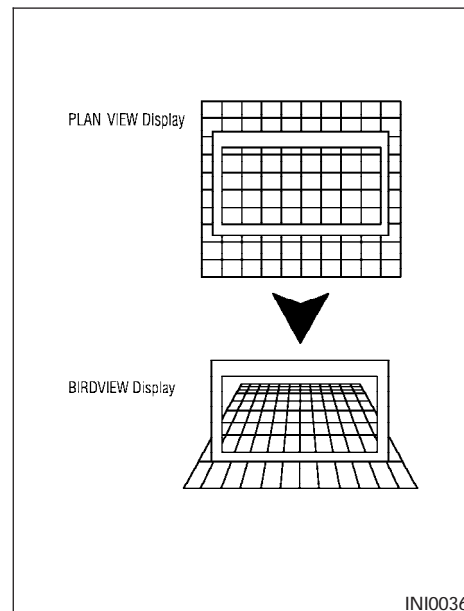
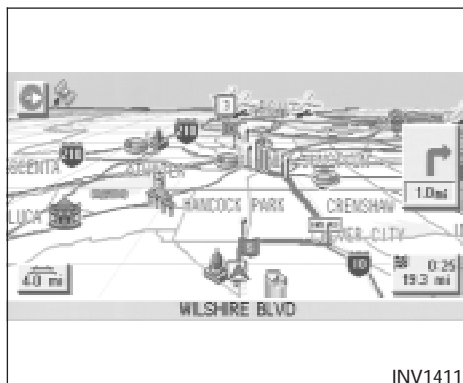
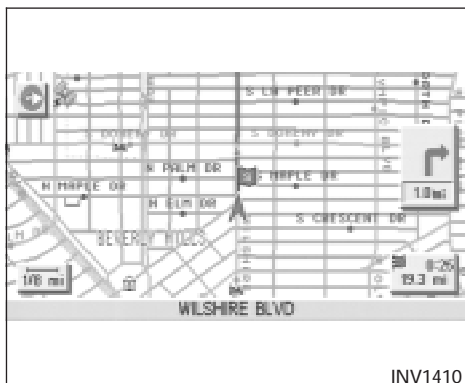

To change between the Birdview™ and Plan View, proceed as follows:

1. Press the **SETTING** button.

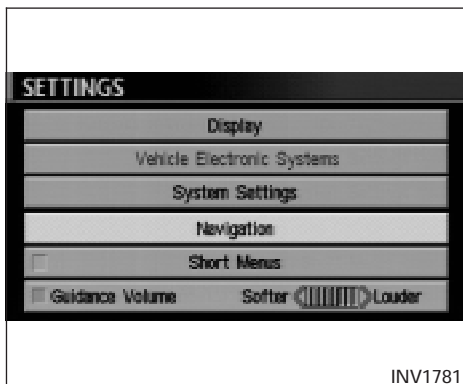

2. Select the **Navigation** key.

The display shows the [NAVIGATION SETTINGS] screen.

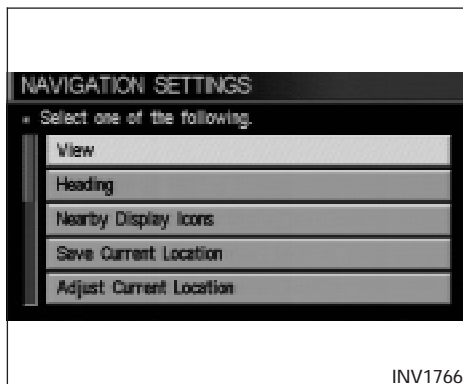

3. Select the **View** key.

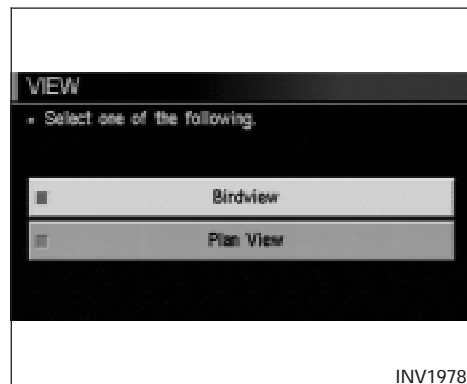

4. Select the **Birdview** or **Plan View** key.

INFO:

Some locations or buildings may be labeled differently in Plan View display and Birdview™ display.

About Birdview™ display



The destination (waypoints) cannot be set in Birdview™ display using the map method.

Set them in Plan View display.

- It always appears with the current forward direction up.

ZOOMING IN AND OUT OF THE MAP

- When the system is re-drawing the display in Birdview™ display, the distance the vehicle travels becomes longer, and/or the degree the vehicle turns becomes larger than in the Planview display in order to complete re-drawing.
- The names of the roads and locations may differ, depending on where the names appear on the screen.
- In order to avoid having too much detail on the map, all road names are not always shown on the screen. When the display re-draws the map, a road name which is shown on the previous screen may not appear on the new screen.

Use the  (**ZOOM IN**) /  (**ZOOM OUT**) buttons to change the scale of the display and height view.

Nine map scales are available from the most detailed (1 : 10,000) to the widest view (1 : 20.48 million).

Each time the  (**ZOOM IN**) button is pressed, the map scale will change one level to display a more detailed map.

Each time the  (**ZOOM OUT**) button is pressed, the map scale will change one level to display a map that shows a wider area.

The chosen map scale will be displayed on the left side of the screen.

INFO:

By pressing the button repeatedly, you can skip the levels to reach the map of desired scale.

Scale level on the Plan View display

Map scale	Actual distance
1 : 20.48 million	160 miles (256 km)
1 : 5.12 million	40 miles (64 km)
1 : 1.28 million	10 miles (16 km)
1 : 320,000	2.5 miles (4 km)
1 : 160,000	1 mile (2 km)
1 : 80,000	1/2 mile (1 km)

Map scale	Actual distance
1 : 40,000	1/4 mile (500 m)
1 : 20,000	1/8 mile (200 m)
1 : 10,000	1/16 mile (100 m)

Scales on the Birdview™ are listed on page 11-2.

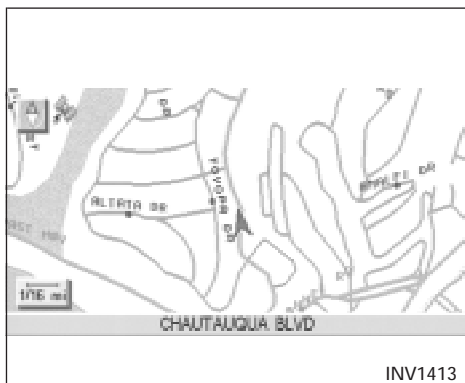

Most detailed level (1: 10,000)

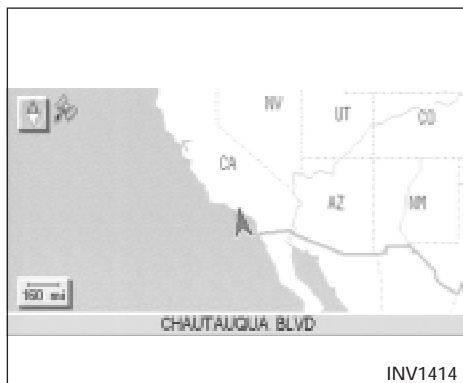

The widest level (1: 20.48 million)

CHANGING THE DISPLAY DIRECTION (in Plan View display)

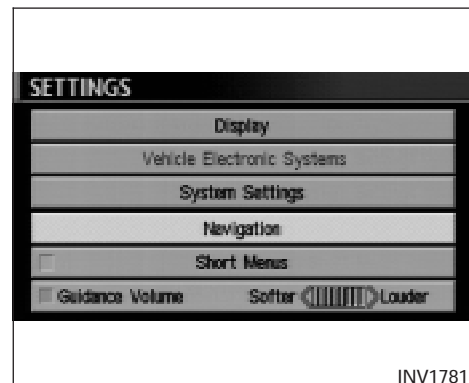

1. Press the **SETTING** button.
2. Select the **Navigation** key on the [SETTINGS] screen.

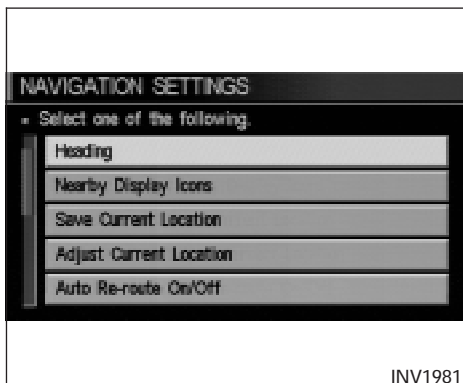

3. Select the **Heading** key on the [NAVIGATION SETTINGS] screen.

The [HEADING] screen will be displayed.

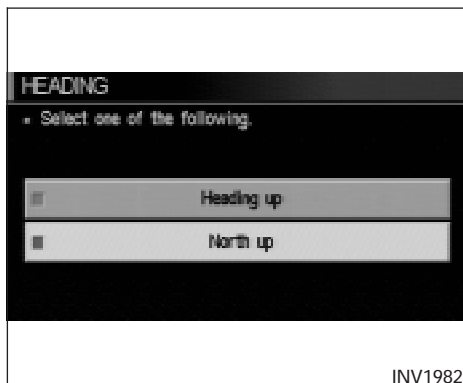

4. Select the **Heading Up** key or the **North Up** key.

The map is displayed as follows:

Heading Up : The map shows the current forward direction up.

North Up : The map shows North up.

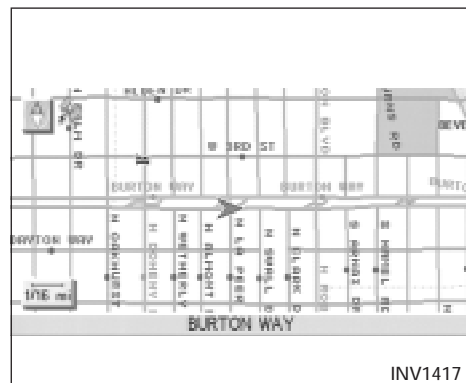

Display with North up

SCROLLING THE MAP

You can manually scroll the map to check the location of your choice.



Display with the forward direction up

INFO:

- When the key is selected, the amber indicator light will light up.
- When the **[MAP]** button is pressed after the display setting, the **[CURRENT LOCATION]** screen will appear.

When the **[PREV]** button is pressed, the previous screen will reappear.

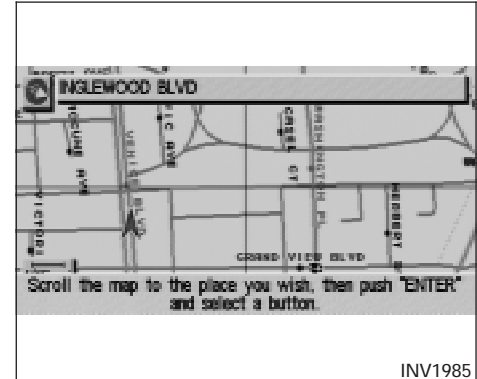

1. Operating the joystick.

The map scrolls in the same direction as the joystick movement.

INFO:

While the vehicle is traveling, a single operation will move within the displayed area of the screen.

2. Press the **[MAP]** button to go back and show the current vehicle position.

INFO:

You can also select the **[PREV]** button to go back.

DISPLAYING THE COMPLETE ROUTE TO THE DESTINATION

You can request to display the complete suggested route to the destination.

1. Press the **ROUTE** button.

Keys will be displayed on the screen.

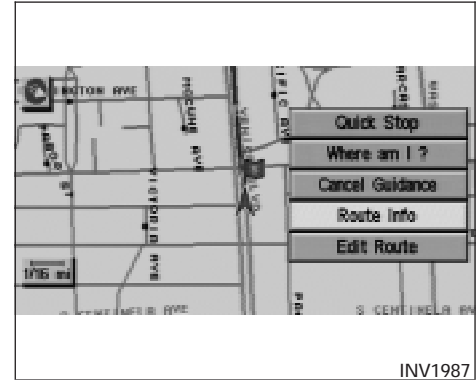

2. Select the **Route Info** key.

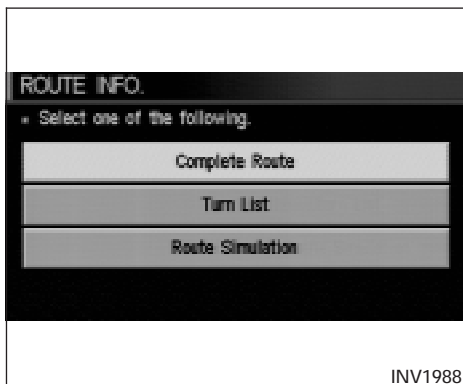

3. Select the **Complete Route** key.

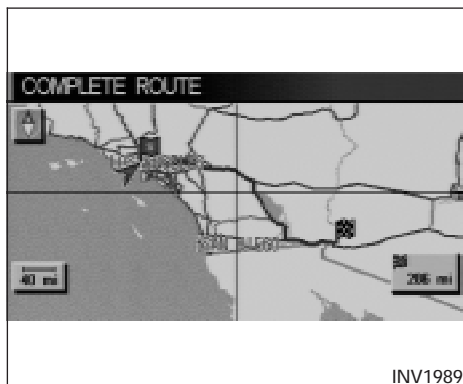

The complete suggested route to the destination will be displayed.

DISPLAYING TURN LIST

You can display the list of guide points to the destination during or after route calculation.

1. Press the **ROUTE** button.

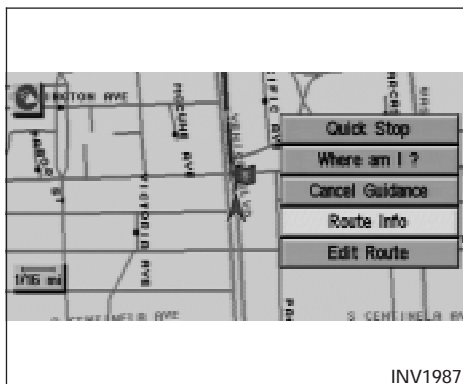

2. Select the **Route Info** key.

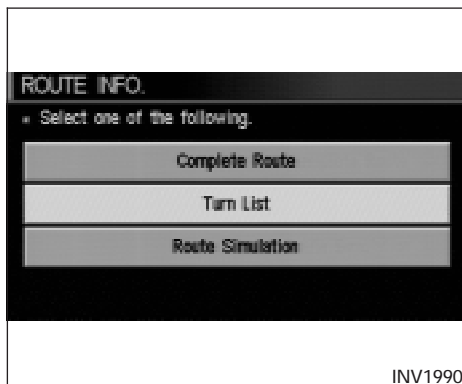

3. Select the **Turn List** key.



A list of destinations, waypoints and guide points will be displayed. Guidance will be made at each guide point which direction to turn.

The distance between the guide points and the travel time will also be displayed.

It may take time to prepare the turn list. In such cases, the **Turn List** key will be highlighted and you cannot select it until calculation is completed.

INFO:

- In the turn list, turning points more than 60 miles (100 km) away from the current vehicle location will not be displayed.

REQUESTING THE SIMULATION DRIVE TO THE DESTINATION

- When calculated routes include a freeway, information about freeway entrances and exits will also be displayed.

You can simulate driving the entire suggested route to the destination on the screen.

1. Press the **ROUTE** button.

Keys will be displayed on the screen.

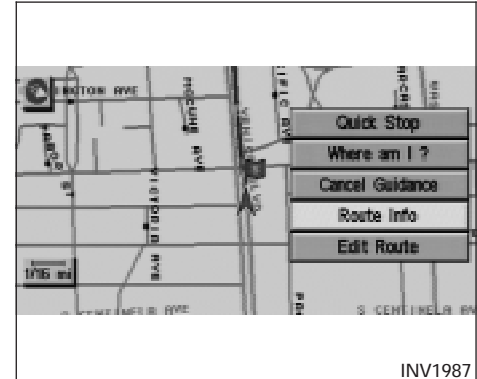

2. Select the **Route Info** key.

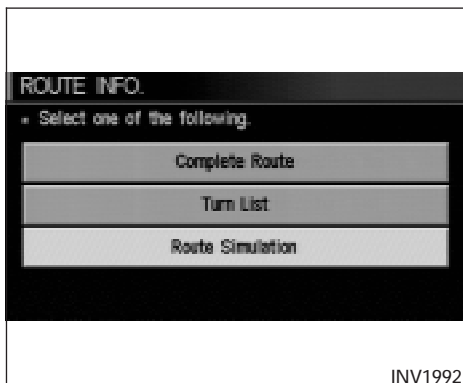

3. Select the **Route Simulation** key.

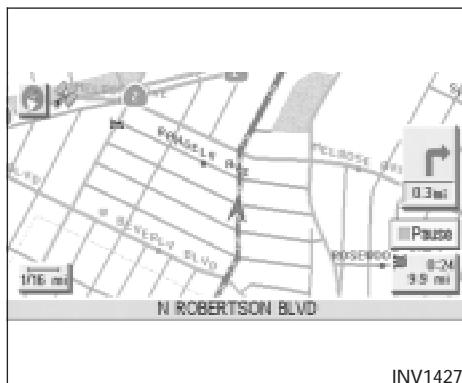

The screen will display a simulated drive with voice guidance on the suggested route to the destination.

4. When the **DEST** button is pressed, or the vehicle starts to run, the route simulation will be canceled.

CANCEL SIMULATION

1. Press the **ROUTE** button during simulation.

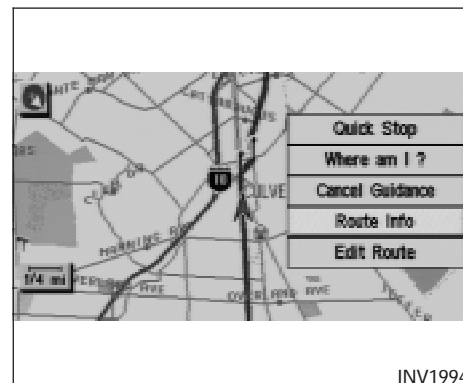

Select the **Route Info** key.

DISPLAYING THE TRACK

You can have the system track the road you have taken, and display it with tracking marks (O).

1. Press the **SETTING** button.

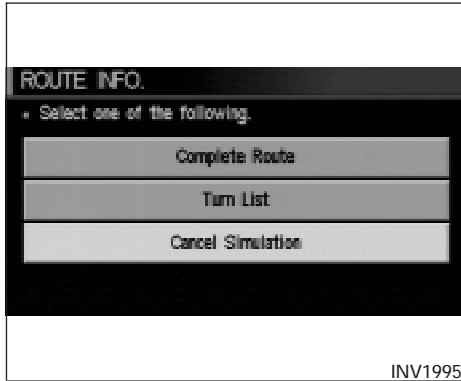

2. The [ROUTE INFO.] screen will be displayed.

Select the **Cancel Simulation** key.

INFO:

When the **DEST** button is pressed, or the vehicle starts to run, the route simulation will be canceled.

INFO:

If you select the **Pause** key, simulation is paused. If you select the key again, the simulation will restart.

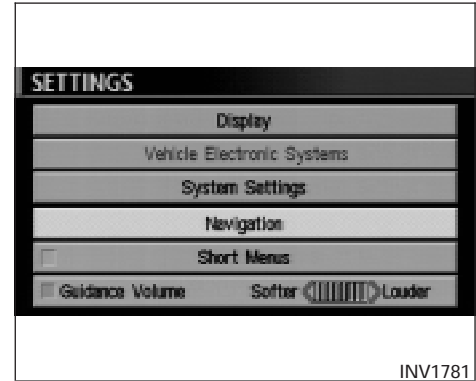

2. Select the **Navigation** key on the [SETTINGS] screen.

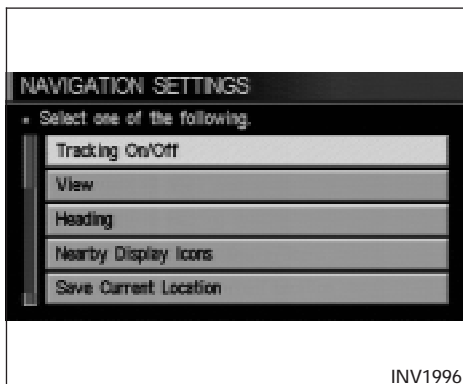

3. Select the key.

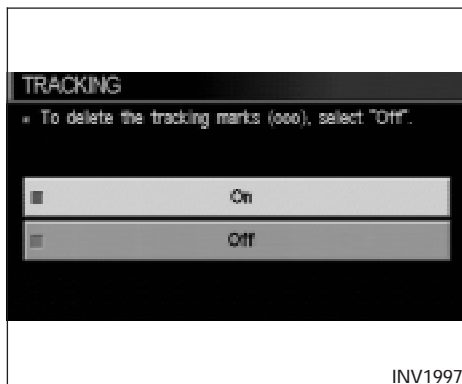

4. Select the key.

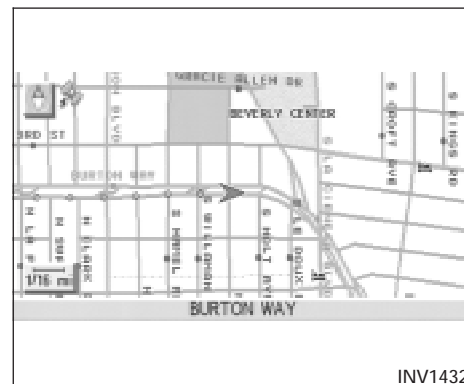

5. Press the button.

The location of the vehicle will be displayed.

INFO:

- You can select the key to display the tracking marks (O), and the key to get rid of them.
- The tracking marks (O) may be spaced differently, according to the scale of the map.
- If you reset the current vehicle location, the tracking marks (O) will be cleared.

GPS INFORMATION DISPLAY

The following GPS information will be displayed on the screen: latitude, longitude, altitude, signal reception, and satellite locations.

1. Press the **SETTING** button.

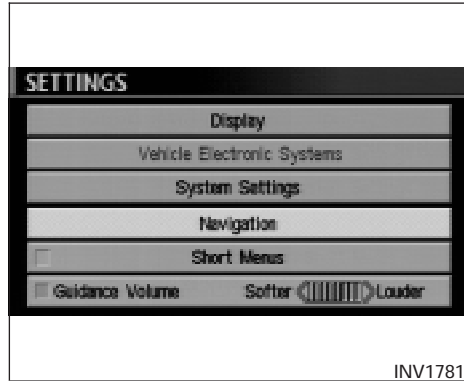

2. Select the **Navigation** key on the [SETTINGS] screen.

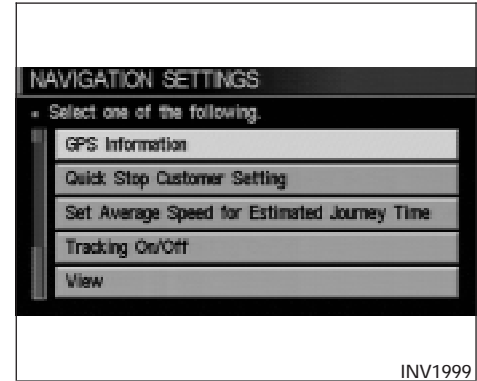

3. Select the **GPS Information** key.
GPS information will be displayed.

UPDATING THE CURRENT VEHICLE LOCATION AND THE DIRECTION

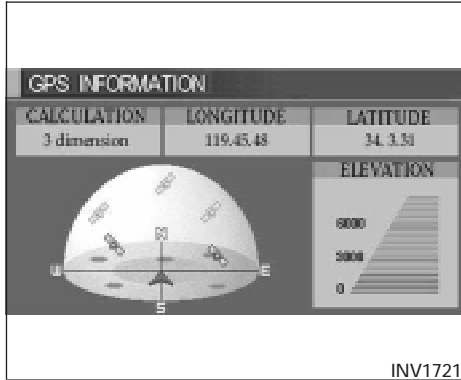

INFO:

- The satellite with the stronger signal will be indicated in green.
- The display will read, [3-dimensional positioning], [2-dimensional positioning], or [positioning not possible], depending on the signal strength. (Elevation will not be displayed in 2-dimensional positioning.)
- When the **MAP** button is pressed, the [CURRENT LOCATION] screen will appear. When the **PREV** button is pressed, the [NAVIGATION SETTINGS] screen will appear.

If the vehicle icon does not indicate the correct location or the direction does not match the actual road, you can adjust them on the map screen.

1. Press the **SETTING** button.

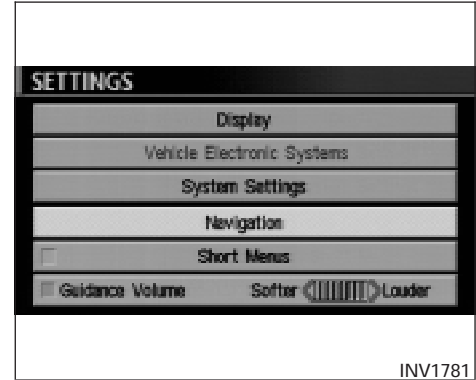

2. Select the **Navigation** key on the [SETTINGS] screen.

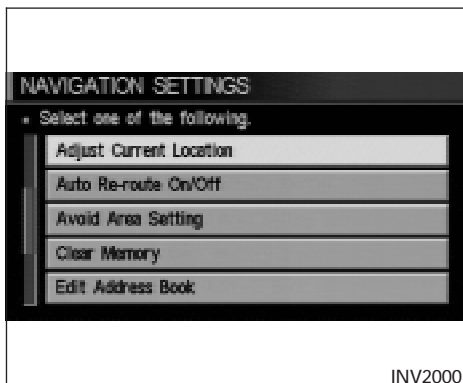

3. Select the **Adjust Current Location** key on the [NAVIGATION SETTINGS] screen.

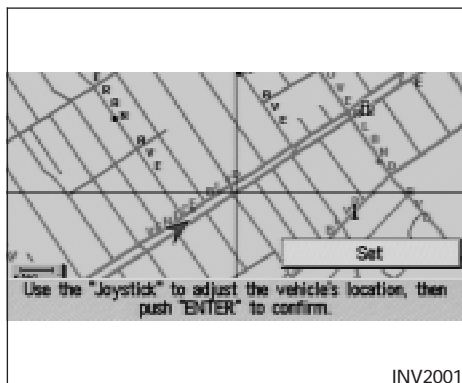

4. Align the correct location to the cross point on the map using the joystick, and select the **Set** key. The current location will be corrected, and the direction adjustment screen will appear.

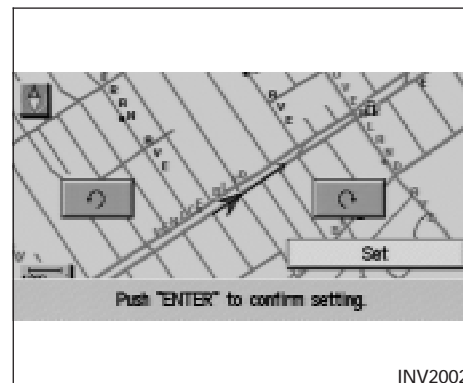

5. Adjust the direction using the ↻ and ↺ keys.
The arrow on the display shows the direction of the vehicle icon.
6. Select the **Set** key.

SETTING THE DISPLAY MODE

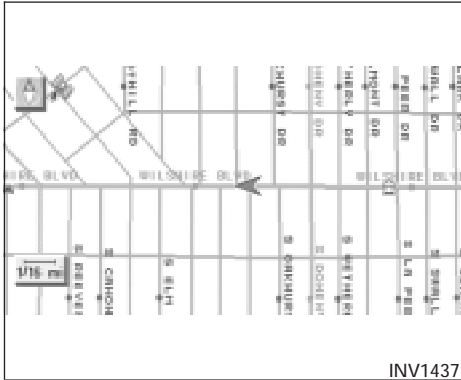

INFO:

- It is not possible to update the vehicle location when the vehicle is moving.
- Depending on the driving conditions, the vehicle icon may not exactly correspond to the actual location of the vehicle. To verify position, refer to map books or check actual landmarks.
- If you notice that the system is displaying a different road from the one the vehicle is actually traveling, and the vehicle icon does not go back to the right road after traveling approximately 6-1/4 miles (10 km), update the vehicle location.

11-20 How do I adjust the display?

You can alter the display mode.

ADJUSTING THE DISPLAY BRIGHTNESS

You can choose the best brightness for the display.

1. Press the **SETTING** button.

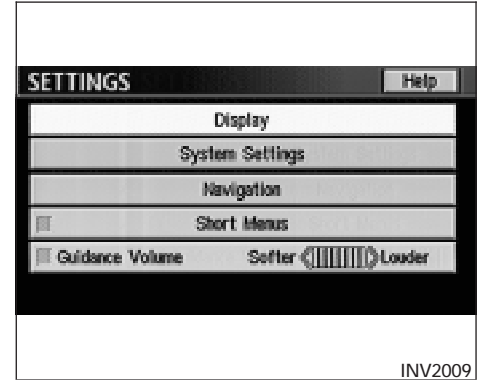

2. Select the **Display** key.

The [DISPLAY SETTINGS] screen will be displayed.

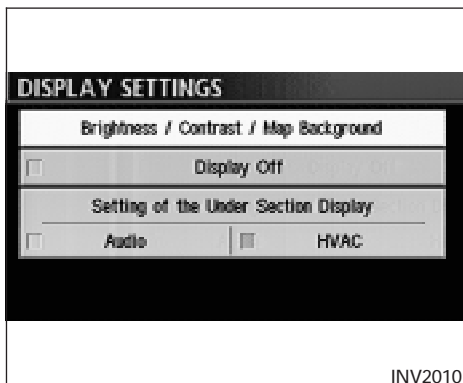

3. Select the

Brightness/Contrast/Map Background key.

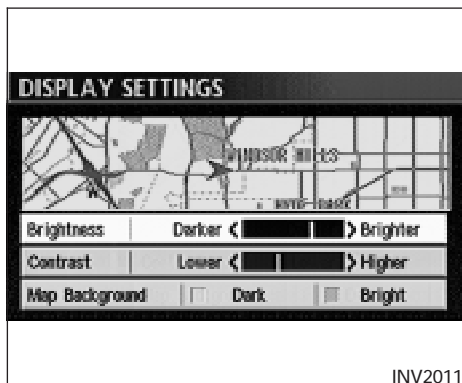

4. Select the **Brightness** key.

When the joystick is tilted to the right, the screen will brighten, and darken when tilted to the left.

INFO:

The screen displayed before pressing the **SETTING** button will be displayed as a sample screen on the [DISPLAY SETTINGS] screen.

ADJUSTING THE DISPLAY CONTRAST

You can choose the best contrast for the display.

1. Press the **SETTING** button.

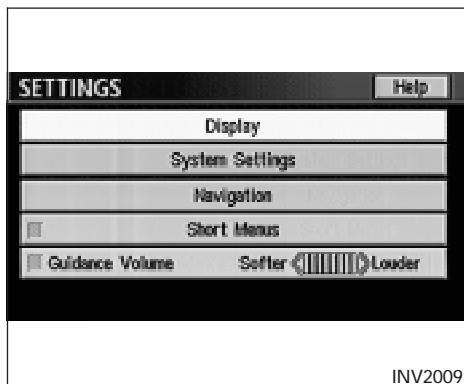

2. Select the **Display** key.

The [DISPLAY SETTINGS] screen will be displayed.

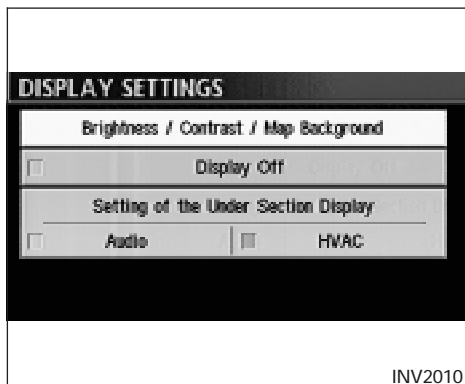

3. Select the **Brightness/Contrast/Map Background** key.

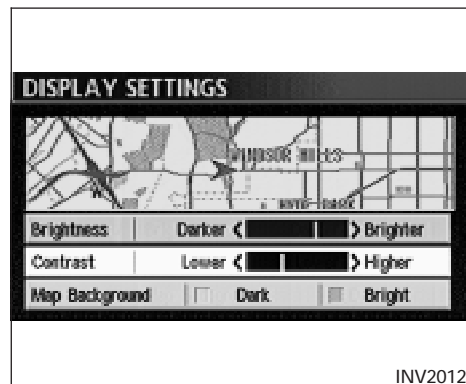

4. Select the **Contrast** key.
 When the joystick is tilted to the right, contrast of the screen will be higher, and will be lower when tilted to the left.

SWITCHING THE DISPLAY COLOR

1. Press the **SETTING** button.

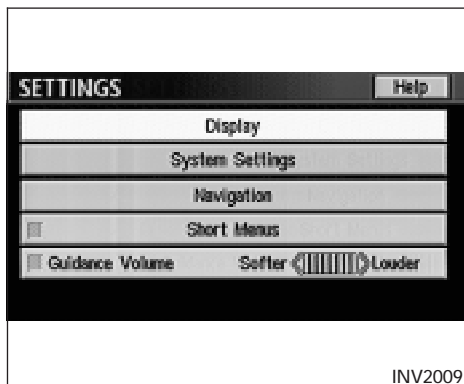

2. Select the **Display** key.

The [DISPLAY SETTINGS] screen will be displayed.

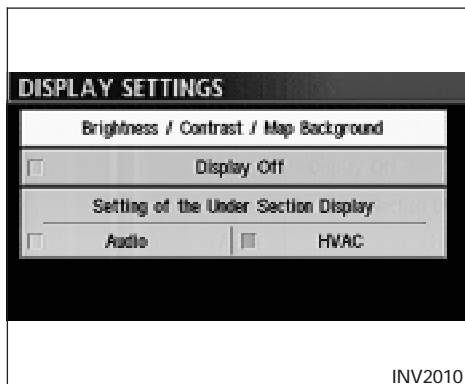

3. Select the

Brightness/Contrast/Map Background key.

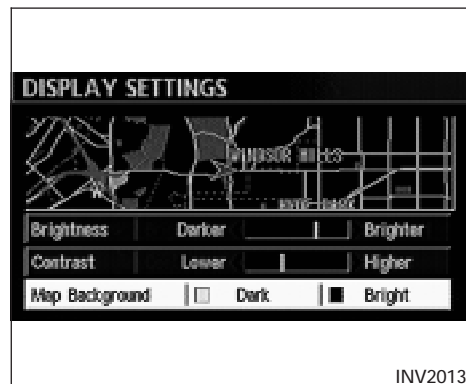

4. Select the **Map Background** key. The display brightness will be altered.

HOW TO HANDLE THE DISPLAY

The display uses liquid crystal and should be handled with care.

WARNING

Never disassemble the display. It has some areas with extreme high voltage. Touching it may result in serious personal injury.

CHARACTERISTICS OF LIQUID CRYSTAL DISPLAY

- If the temperature inside the vehicle is especially low, the display will stay relatively dim or the movement of the images may be slow. These conditions are normal; when the temperature rises, the display will function normally.
- You may notice darker or brighter dots in parts of the display; this is inherent in monitor displays and is not a malfunction.
- You may also notice a remnant of the previous display image on the screen. This afterimage is inherent in displays and is not abnormal.

INFO:

The screen may become distorted by strong magnetic fields.

11-24 How do I adjust the display?

MAINTENANCE OF THE DISPLAY

CAUTION

- **To clean the display, never use a rough cloth, alcohol, benzene, thinner, any kind of solvent, or paper towel with chemical cleaning agent. They will scratch or deteriorate the panel.**
- **Do not splash any liquid such as water or car fragrance on the display. Contact with liquid will cause the system to malfunction.**

If you need to clean the display screen, use a dry soft cloth. If additional cleaning is necessary, use a small amount of neutral detergent with a soft cloth. Never soak the exterior with water or detergent.

12 Information on map data discs

How to order map data DVD-ROM updates12-2
How to handle the DVD-ROM12-2
 About the navigation map DVD-ROM12-3

Icons12-3
Abbreviations definition list12-6



HOW TO ORDER MAP DATA DVD-ROM UPDATES

To order updated mapping DVD-ROMs or additional DVD-ROMs, please contact the INFINITI Navigation System help desk at:

- ADDRESS: P .O. Box 2082, Burlingame, CA 94011
- E-MAIL: customersupport@zenrin.com
- WEB SITE: www.zenrin.com
- PHONE: 1-888-661-9995
- HOURS: 6:00 AM to 5:00 PM (Pacific Time)

HOW TO HANDLE THE DVD-ROM

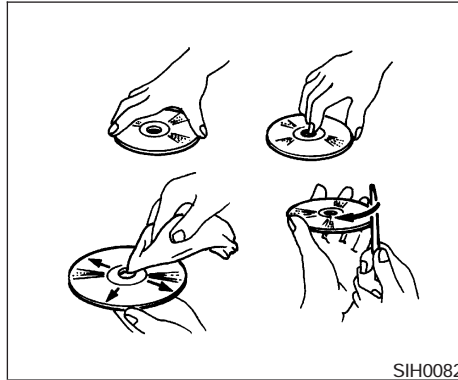

⚠ CAUTION

- **Handle a DVD-ROM by its edges. Never touch the surface of the disc.**
 - **To clean a disc, wipe the surface from the center to the outer edge using a clean, soft cloth. Do not wipe the disc using a circular motion.**
- Do not use a conventional record cleaner, benzene, thinner or alcohol intended for industrial use.**

- **A new disc may be rough on its inner and outer edges. Remove the rough edges using the side of a pen or pencil as illustrated.**
- **Never attempt to use a DVD-ROM that has been cracked, deformed, or repaired using adhesive. Doing so may cause damage to the equipment.**

- Handle the DVD-ROM carefully to avoid contamination or flaws. Otherwise, signals may not be read properly.
- Do not write, draw or attach anything on any side of the DVD-ROM.
- Do not store the DVD-ROM in locations exposed to direct sunlight or in high temperatures or humidity.
- Always place the discs in the storage case when they are not being used.
- Do not put on any sticker or write anything on either surface of the DVD-ROM.

ABOUT THE NAVIGATION MAP DVD-ROM

1. This navigation map DVD-ROM has been prepared by ZENRIN CO., LTD. under license from Navigation Technologies Corporation. ZENRIN CO., LTD. has added, processed and digitized data based on the digital road map data of Navigation Technologies Corporation. Due to the production timing of the map data, some new roads may not be included in this map data or some of the names or roads may be different from those at the time you use this DVD-ROM.
2. Traffic control and regulation data used in this DVD-ROM may be different from those at the time you use this DVD-ROM due to the data production timing. When driving your vehicle, follow the actual traffic control signs and notices on the roads.
3. Reproducing or copying this map software is strictly prohibited by law.

Published by NISSAN North America, Inc.

© 2002 Navigation Technologies. All rights reserved. "Certain business data provided by infoUSA.com, Inc. Copyright 2002, All rights reserved".

ICONS

Icon legend follows:



Airport



Historical Monument



Police Station



Amusement Park



Hotel or Motel



Rest Area



City Hall



Museum



Shopping Center



Court House



Open Parking Area



Sports Complex



Ferry Terminal



Parking Garage



Tourist Office



Golf Course



Gas Station



University/College

INI0094

Note: Only some limited landmarks are displayed with 3-D icons on the BirdView™ display. In some areas, no 3-D icons may be displayed depending on the location.

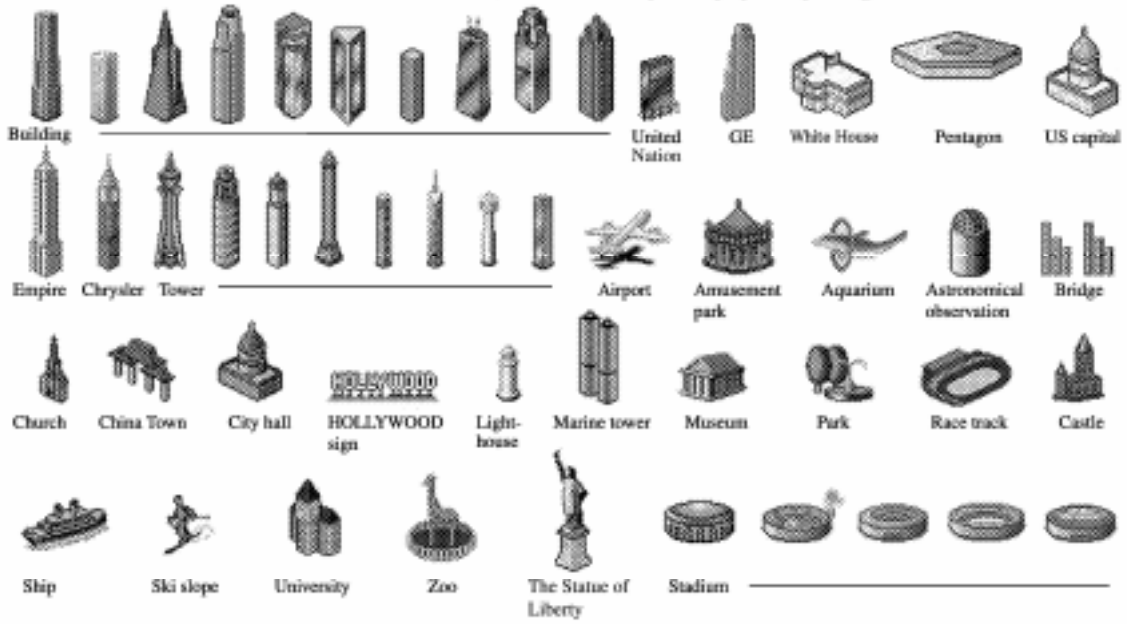

INV1183

ABBREVIATIONS DEFINITION LIST

Abbreviation	Meaning
ACCS	ACCESS
ACRS	ACRES
ALY	ALLEY
APPR	APPROACH
AVE	AVENUE
BCH	BEACH
BND	BEND
BLF	BLUFF
BLVD	BOULEVARD
BRG	BRIDGE
BRK	BROOK
BYP	BYPASS
BYWY	BYWAY
CYN	CANYON
CSWY	CAUSEWAY
CTR	CENTER
CHSE	CHASE
CIR	CIRCLE
CLFS	CLIFFS
CLB	CLUB
COR	CORNER
CT	COURT

Abbreviation	Meaning
CV	COVE
CRK	CREEK
CRES	CRESCENT
XING	CROSSING
CURV	CURVE
DL	DALE
DR	DRIVE
EST	ESTATES
EXP	EXPRESS
EXPY	EXPRESSWAY
EXT	EXTENSION
FRY	FERRY
FLD	FIELD
FLDS	FIELDS
FLTS	FLATS
FRD	FORD
FWY	FREEWAY
GDNS	GARDENS
GTWY	GATEWAY
GLN	GLEN
GRV	GROVE
HVN	HAVEN

Abbreviation	Meaning
HTS	HEIGHTS
HWY	HIGHWAY
HL	HILL
HLS	HILLS
HOLW	HOLLOW
JCT	JUNCTION
KY	KEY
KNL	KNOLL
KNLS	KNOLLS
LNDG	LANDING
LN	LANE
LCK	LOCK
MNR	MANOR
MDWS	MEADOWS
ML	MILL
MT	MOUNT
MTN	MOUNTAIN
OPAS	OVERPASS
PKWY	PARKWAY
PSGE	PASSAGE
PNES	PINES
PL	PLACE

Abbreviation	Meaning
PLZ	PLAZA
PT	POINT
PROM	PROMENADE
RNCH	RANCH
RDG	RIDGE
RD	ROAD
SHRS	SHORES
SPGS	SPRINGS
SQ	SQUARE
ST	STREET
SUBD	SUBDIVISION
SMT	SUMMIT
TER	TERRACE
TRCE	TRACE
TRAK	TRACK
TRL	TRAIL
TUNL	TUNNEL
TPKE	TURNPIKE
VLY	VALLEY
VIA	VIADUCT
VW	VIEW
VLG	VILLAGE

Abbreviation	Meaning
VIS	VISTA

MEMO

13 Troubleshooting guide

Customer assistance	13-2	Destination, waypoints or menu contents cannot be chosen or set	13-7
Basic operations	13-3	Voice guidance	13-8
Vehicle icon	13-4	Route calculation	13-9
Map DVD-ROM	13-6		



CUSTOMER ASSISTANCE

For assistance or inquiries about the INFINITI Navigation System, please contact:

The INFINITI Navigation Helpdesk at 1-800-662-6200 or visit the INFINITI website at www.infiniti.com.

BASIC OPERATIONS

Symptom	Possible cause	Remedy
No image comes on.	The brightness adjustment is at the lowest setting.	Adjust the settings to make the display brighter.
No map comes on the screen.	No map DVD-ROM is inserted, or it is inserted upside down.	Insert the DVD-ROM correctly.
	The map display mode is switched off.	Press the MAP button.
No voice guide is available. or The volume is not high enough.	The volume is not set correctly or turned off.	Adjust the volume correctly.
The screen is too dim. The movement is slow.	The temperature in the vehicle is low.	Wait for the temperature in the vehicle to rise.
There are a few darker or brighter dots in the display.	This is inherent to displays. This condition is a characteristic of liquid crystal displays.	This condition is not abnormal.

- Stored location in the address book and other memory functions may be lost if the vehicle's battery is disconnected or becomes discharged for a long time.

If this should occur, service the vehicle's battery as necessary and re-enter the address book information.

VEHICLE ICON

Symptom	Possible cause	Remedy
The location names differ, between Planview and Birdview™.	This is because the displayed information is reduced so that the screen does not become too crowded. There is also a chance that names of roads or locations will be displayed twice. The name appearing on the screen may be different because of a processing procedure.	This should not be regarded as abnormal.
The vehicle icon is not shown correctly.	The vehicle might have moved with the ignition off, for example on a ferry boat or car transporter.	Drive the vehicle with the GPS on for some distance.
The screen does not switch to night screen even after turning the headlights on.	When the lights were last turned on, the last setting was the daytime screen.	Turn the headlights on again, go to [DISPLAY SETTING] screen and set it to the night screen.
The map does not scroll even when the vehicle is traveling.	The display is not switched to the map screen.	Press the MAP button.
The vehicle icon does not show up.	The display is not switched to the map screen.	Press the MAP button.
GPS indicator on the screen remains gray.	GPS signals are not received because the vehicle is indoors or in the shade of buildings.	Move the vehicle outdoors with a clear view of the sky.
	GPS signals are not received because some objects are placed on the instrumental panel.	Remove the objects from the instrumental panel.
	GPS satellites are in poor locations.	Please wait for the satellites to move to better locations.

Symptom	Possible cause	Remedy
The location of vehicle icon does not match the actual position.	Driving on slippery road surface.	If the position marker does not move to the correct position even after the vehicle has been driven approximately 6 miles (10 km), adjust the current location. If necessary, adjust the moving speed of the vehicle. If the symptom still exists, contact your INFINITI dealer.
	Driving on slanted area.	
	Rough or violent driving.	If the position marker does not move to the correct position even after the vehicle has been driven approximately 6 miles (10 km), adjust the current location.
	GPS indicator remains gray.	Please check the GPS indicator on the screen to see if it remains gray. If it remains gray, drive the vehicle to a place where the GPS signals can be received.
	Because the vehicle has tire chains on, or the system was transferred to a different vehicle, errors (gain or loss) result in calculating the speed from the speed pulse.	The location of the vehicle icon will move by driving the vehicle for 30 minutes (in case it is running at 18-3/4 miles/hour (30 km/h)). If you still notice errors, adjust moving speed. If the symptom still exists, contact your INFINITI dealer.
	The map data has an error or is incomplete (if the location error always happens in the same area).	Please wait for the update of the Map DVD-ROM.

MAP DVD-ROM

Symptom	Possible cause	Remedy
The message "Error" appears after operation.	Map DVD-ROM is soiled or partially damaged.	Check the DVD-ROM and wipe it clean with a soft cloth, following cautions and instructions on page 12-2.
		If you see any damage, replace the DVD-ROM.

DESTINATION, WAYPOINTS OR MENU CONTENTS CANNOT BE CHOSEN OR SET

Symptom	Possible cause	Remedy
Turn list is not displayed.	Route search does not occur.	Set designation areas and perform route search.
	Vehicle marker does not appear on recommended route.	Drive on the recommended route.
	Route guide is OFF.	Turn the route guide ON.
In rerouting, the waypoints are not included in the calculation.	The system has judged that the vehicle has already passed the point being chosen or set.	If you want to go to that point again, edit the route again.
Route information is not displayed.	Route calculation has not yet been requested.	Set the destination and request route calculation.
	The vehicle icon is not on the suggested route.	Please drive the vehicle along the suggested route.
	Route guidance is off.	Turn the route guidance on.
Route is not calculated automatically.	The vehicle is not running on a route from which calculation can occur.	Enter a route from which calculation can occur. Alternatively, you can calculate the route manually. In this case, the entire route will be calculated again.
It is impossible to request a detour.	Your vehicle is not running on the suggested route.	Restart route calculation or enter the suggested route.
The detour found is the same as the previous suggestion.	The system took many conditions into consideration, but the same result was obtained.	This condition is not abnormal.
It is impossible to set the waypoints.	The number of waypoints exceeds 5.	It is impossible to set more than 5 waypoints. Please decrease the number of the waypoints.
Some items in the menu cannot be selected.	The vehicle is moving.	Park the vehicle in a safe place and select the desired items for the suggested route.

VOICE GUIDANCE

Symptom	Possible cause	Remedy
The voice guidance is not available.	Voice guidance is only available at certain intersections marked with  . In some cases, the guidance is not available even when the vehicle should make a turn.	This condition is not abnormal.
	The vehicle is off the suggested route.	Go back to the suggested route or request route calculation again.
	Voice guidance is set OFF.	Turn the voice guidance ON.
	Route guidance is set OFF.	Turn the route guidance ON.
The guidance content does not correspond to the actual condition.	The content of the voice guidance may vary, depending on the types of junctions at which turns are made.	Follow the actual rules and regulations of the roads upon which you are driving.

ROUTE CALCULATION

Symptom	Possible cause	Remedy
Although the system is set with the moving direction as the preference, it does not find the route by matching the preference.	There is no route found in that direction.	This condition is not abnormal.
Route is not indicated.	There is no road that can be found by this system close to the destination.	Reset the destination closer to the road displayed in orange. Especially with roads which have separate lanes for opposite directions, be careful in setting the destination or waypoints on it, because results may differ depending on the lane you choose.
	The starting point to the destination is too close.	Set more distant destinations.
	The present location is about 1,100 miles (1,770 km) away from the destination.	Set the destination to within 1,100 miles (1,770 km).
The route is not displayed continuously at waypoints, for example, that are not calculated route from the vehicle's current position.	Suggested routes may be displayed discontinuously near waypoints as route calculation is done at each waypoint.	This condition is not abnormal.
The suggested route the vehicle has traveled is erased.	Suggested routes are stored in memory by the blocks; if the vehicle travels past waypoint block 1, the previous data will be erased.	This condition is not abnormal.
A route with many detours is suggested.	If there are restrictions (such as one-way traffic) on roads close to the starting point or destination, the system may suggest a detoured route.	Try slightly moving the starting point or destination.
The landmark description does not correspond to the actual one.	This may be caused by insufficient or incorrect data on the DVD-ROM.	Exchange the Map DVD-ROM. The new DVD-ROM will be updated.
The suggested route does not exactly connect to the starting point, waypoints, or destination.	There is no data for route calculation closer to these points.	Set these points on the main road displayed in thick orange. Please note that in some cases even main roads lack the data for route calculation.

MEMO

14 Index

A

- Address book (Editing) 7-8
- Address book (Setting) 7-2
- Address/Street 5-7
- Automatic re-routing 9-2
- Avoid areas (Editing) 8-5
- Avoid areas (Setting) 8-2

B

- Birdview™ display 11-2

C

- Clear memory 4-15
- Complete route 11-10

D

- Destination (Adjusting) 5-37
- Destination (Deleting) 5-37
- Destination (Setting) 5-2
- Detour 9-3
- Display (Direction) 11-7
- Display (Error) 4-20
- Display (Maintenance) 11-24

E

- Enlarged intersection display 5-36

G

- GPS (Global Positioning System) 2-2

H

- Heading 11-7

I

- Icon (Changing) 7-9
- Icon (Legend) 12-6, 7-13
- Information on screen
(Planview/Birdview™) 11-2
- Intersection 5-14

J

- Joystick 4-3

L

- Liquid crystal display (LCD) 11-24

M

- Map coverage areas 2-3
- Map DVD-ROM 13-6

N

- Nearby display icons 6-12

P

- Point of interest (POI) 6-2
- Preference for route calculation 5-35
- Previous Dest. 5-5

Q

- Quick stop 5-41
- Quick stop customer settings 5-42

R

- Reference symbols 1-2
- Route calculation and guidance 5-35
- Route guidance 3-2, 4-18

S

Safe operation1-2
Safety note1-2
Simulation drive11-13
Storing current vehicle position7-4

T

Tracking11-15
Turn list.11-11

U

Updating the current vehicle location and the direction11-18
--	--------

V

Voice guidance (Notes)11-2
----------------------------------	-------

W

Waypoint (Adjusting)5-37
Waypoint (Deleting)5-37
Waypoint (Setting)5-32
Where am I?5-44

Z

Zoom in (IN)11-6
Zoom out (OUT)11-6

KEY

Address Book	key5-3	Edit Address Book	key7-3	Plan View	key11-5
Address/Street	key5-7	Edit Route	key.9-4	Point of Interest (POI)	key6-2
Adjust Current Location	key.11-19	GPS Information	key.11-17	Previous Dest.	key5-5
All Clear	key5-40	Guidance Volume	key.10-2	Priorities	key5-33
Area	key8-4 , 8-9	Heading	key11-8	Quick Stop	key5-41
Auto Re-route On/Off	key9-2	Heading Up	key.11-8	Quick Stop Customer Setting	key.5-43	
Avoid Area Setting	key8-2	Home	key.5-30	Rename	key7-9 , 8-6
Avoid Freeway	key8-4 , 8-9	I AGREE	key.4-12	Return All Settings to Default	key .4-18	
Avoid the Current Street	key9-4	Intersection	key5-14	Route Info	key4-9
Birdview	key11-5	Landmark Icon	key7-11	Route Simulation	key11-14
Cancel Guidance	key5-45	List	key6-2	Route calc.	key5-35
Cancel Simulation	key11-15	Louder	key10-2	Save Current Location	key7-4
Category	key6-5	Map	key.5-27	Set Average Speed for Estimated Journey Time	key4-18
City	key5-21	Minimize FWY	key5-34	Short Menu	key3-4
Clear Memory	key4-6	Minimize Toll Road	key5-34	Shortest Distance	key5-34
Complete Route	key.11-11	Navigation	key.4-5	Shortest Time	key5-34
Country	key5-29	Nearby	key6-12	Softer	key.10-2
Destination	key5-5	Nearby Display Icons	key6-14	Sort	key.7-7
Detour	key9-4	North Up	key.11-8	State	key6-3
ENTER	key.4-12	Pause	key.11-15			
			Phone Number	key.5-25			

Store Place	key	7-5
Tracking On/Off	key	11-16
Turn List	key	11-12
Use Ferry Route	key	5-35
Use Time Restricted Roads	key	5-34
View	key	11-5
Waypoint	key	5-28
Where am I?	key	5-44

BUTTON

DAY/NIGHT	4-3
DEST	4-7
EJECT	4-3
GUIDE VOICE	10-3
JOYSTICK and ENTER	4-3
MAP	5-36
PREV	4-4
ROUTE	4-8
SETTING	4-4
TRIP	4-3
ZOOM IN	11-6
ZOOM OUT	11-6

