



2018 RAM PROMASTER CITY

AMERICA'S MOST EFFICIENT WORK VAN^{1*}



Ram ProMaster City® Tradesman® SLT Cargo Van. Properly secure all cargo.

BRING OUT THE BEST.

WE KNOW EXACTLY WHAT YOU'RE LOOKING FOR. And Ram ProMaster City puts it all into perspective, focusing on low costs of operation, impressive resale value, and a list of best-in-class features that leave the competition looking on with envy. With its functional yet elegant design, outstanding occupant comfort, proven durability and efficiency and performance at the top of the game, Ram ProMaster City vaults into first-place consideration for your business or family.



The basis of ProMaster City at a glance? Superiority. Start with the powertrain, where the 2.4L Tigershark® MultiAir®2 I-4 engine and **class-exclusive² 9-speed automatic transmission** deliver **best-in-class² horsepower and torque** and **best-in-class³ 28 mpg highway[†] fuel economy.**

Capability is also at the top of its form. ProMaster City delivers **best-in-class² payload—up to 1,883 lb; best-in-class² cargo capacity—**

131.7 cubic feet (about three washer/dryer sets, for a fast comparison of this vast interior volume); and **best-in-class² cargo width between the wheel wells—it's 48.4 inches**, easily accommodating a standard pallet.

Build strength starts with a steel backbone that helps enable **an unsurpassed² towing rating to handle trailers up to 2,000 lb** when properly equipped. The all-important GVWR is also at the top: this **best-in-class² GVWR of 5,395 lb** joins a no-nonsense GCWR that comes in at a solid and respectable 5,900 lb.

Created specifically for a cost-conscious business or a large family, and designed for cities and suburbs, Ram ProMaster City supplies it all: ultra-efficient performance. Multiple bests for capability. And all designed for low costs of ownership and operation. For more information, click over to ramtrucks.com/promastercity

*A note about this brochure: all disclaimers and disclosures can be found on page 26.
†EPA estimated 21 mpg city/28 mpg hwy. Actual results may vary.



Ram ProMaster City Wagon SLT with available Roof Rack Side Rails by Mopar®, aluminum wheels and fog lamps.



RAM
COMMERCIAL



**BEST-IN-CLASS¹
HWY FUEL ECONOMY**

28 MPG HWY^{*}

**2.4L TIGERSHARK¹
MULTIAIR2 1-4**

OUR FOCUS ON LOW COSTS OF OWNERSHIP PAYS OFF EVERY DAY—AND OVER THE YEARS. Impressive performance is in the very DNA of the **gas-sipping 2.4L Tigershark 4-cylinder**. With **MultiAir2 technology**, and mated to the **class-exclusive² and super-efficient 9-speed automatic transmission**, this is a team that enables **best-in-class³ hwy fuel economy** along with impressive on-road responsiveness: the 0–30 mph takeoff in only 3.7 seconds makes accelerating onto a freeway ramp a breeze.

A driving range that can reach up to 448 miles[†] on a single tank of 87-octane regular, and oil change intervals as seldom as every 10,000 miles point to **decidedly low costs of ownership and operation**. Factor in the outstanding protection of a **5-Year/60,000-Mile Powertrain Limited Warranty⁴** and it's clear: along with a wealth of best-in-class assets, Ram ProMaster City[®] also delivers superb value.

5YR/60,000MI⁴
POWERTRAIN LIMITED WARRANTY

^{*}EPA estimated 21 mpg city/28 mpg hwy. Actual results may vary.

[†]EPA estimated 21 mpg city/28 mpg hwy and 16-gallon fuel tank. Actual results may vary.

BEST-IN-CLASS² CARGO CAPACITY.



131.7
CUBIC FEET

NIMBLE. EFFICIENT. AND BEST-IN-CLASS WHERE IT COUNTS.

What really counts with Ram ProMaster City® is a purpose-driven design that delivers superior capacity. This Cargo Van comes through with flying colors—and all the right numbers. The Tradesman® and Tradesman SLT Cargo Van trim levels offer a vast rear area with cargo floor length greater than 7 feet. Dealing with pallets? Huge 48-inch-wide rear doors open into a **best-in-class² 48.4-inch cargo width between the wheel wells**—just right when you need to load a standard pallet.

The spacious interior is ideal for large items—think typical appliances for the kitchen or laundry room—with 51.8 inches measuring from floor to interior roof. Convenient passenger-side and rear

overhead lamps in the cargo compartment and up to six D-type tie-down rings (integrated in the floor, with up to 1,000-lb capacity when in use) add to functionality—and to leadership.

Cargo capacity here is best-in-class²: 131.7 cubic feet. Payload also ranks with top-tier superiority, with a best-in-class² capability up to 1,883 pounds.

The crowning touch is that both Cargo Van and Passenger Wagon models can further ramp up your can-do attitude and carrying power: versatile available Roof Rails from our friends at Mopar® enable up to 150 pounds of roof-ready hauling capability.

ROOF WEIGHT CAPACITY

150 LB*

*When properly equipped.

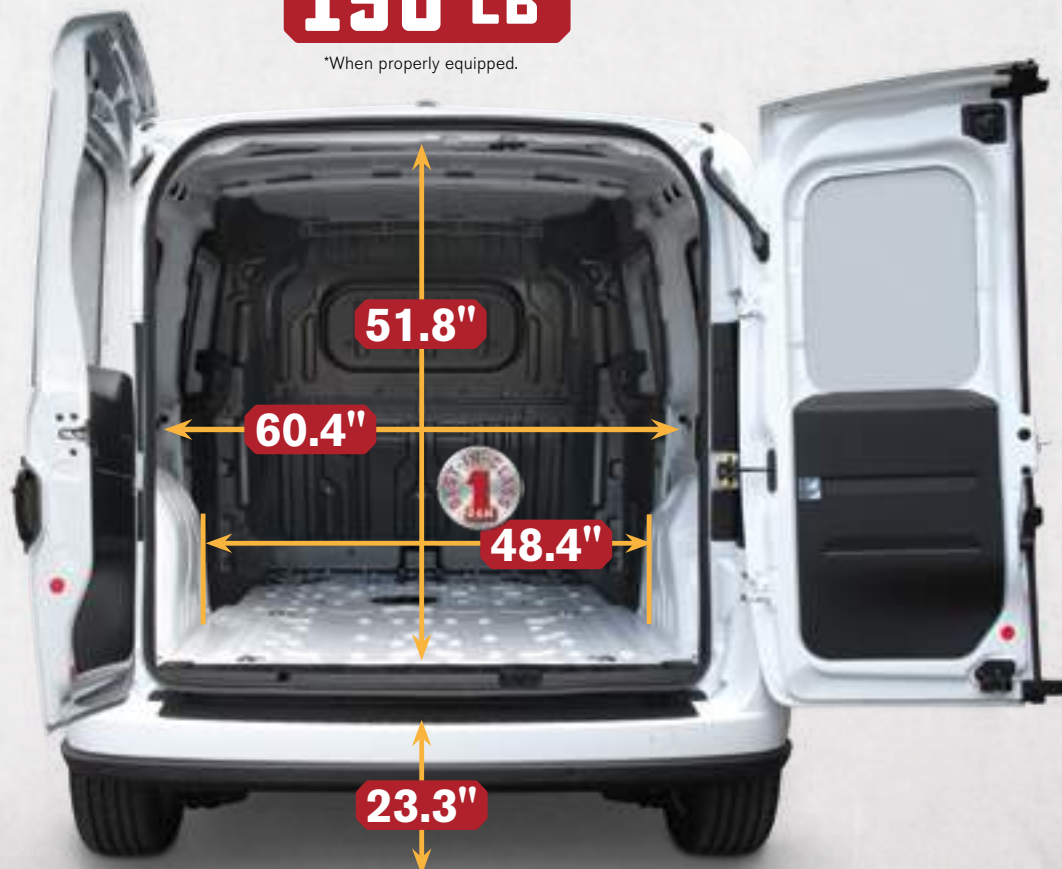

CARGO AREA LENGTH **87.2"**



BEST-IN-CLASS²

1,883 LB

MAXIMUM PAYLOAD



BEST-IN-CLASS²

48.4 INCHES

CARGO WIDTH BETWEEN THE WHEEL WELLS



**SHIFT YOUR BUSINESS PLAN
INTO HIGH GEAR.**

**NEED A MOBILE WORKSHOP?
THIS CITY IS ZONED FOR IT.**





INSIDE AND OUT, IT'S READY-MADE FOR AN UPFIT. It totally measures up, starting with that **best-in-class² cargo capacity of 131.7 cubic feet.** Now add the assets: seven feet of flat cargo floor length. Huge 60/40 split rear doors. Nearly vertical side walls. But let's get real: the total volume of a side-by-side fridge/freezer is around 32 cu ft; a typical washer and dryer combination, around 48 cu ft.

Take a moment to compare those figures to this cavernous 131.7 cu ft, and start thinking about an upfit with room for supplies and equipment, or a mobile workshop with leftover space to accommodate additional storage for tools and other materials.



NEED EXTRA CAPABILITY? HIT THE ROOF. The **unsurpassed² towing (up to 2,000 lb when properly equipped)** and the **best-in-class² payload (up to 1,883 lb)** show clearly how capability is built into every Ram ProMaster City[®] model.

Maximize it further: use the predrilled receivers in the roof for available Roof Rails, which can handle up to 150 lb of carrying capacity. And since we shared these specs with other manufacturers, you can choose from those sources, as well as from the many Authentic Accessories from Mopar[®]. The winning strategy to this game is adaptability and versatility. Your Ram ProMaster City scores big in every area.

FROM PAINT TO PALLET, THIS VAN HANDLES IT. Competitively offering 51.8 inches from floor to ceiling, Cargo Van also gives you **best-in-class² cargo width between the wheel wells.** Shown at left: even with custom shelving installed along the walls, there's still enough room in the center cargo area for additional equipment and supplies. Illustrated at right: while each of these five-gallon paint cans weighs about 50 lb, these five take up a mere fraction of the **best-in-class² payload figure—up to 1,883 lb.** The figure reflects pure capability: this Cargo Van welcomes a standard loaded pallet.



IN-CABIN VERSATILITY

ADDING TO FUNCTIONALITY AND SECURITY, these tough available partitions are constructed of molded steel and fully separate the front cabin from the cargo area—ideal when carrying valuable equipment. Windowed partition lets you use the rearview mirror while keeping a sharp eye on materials in back. All partitions include rear wall trim.



OPEN TO CABIN

Standard on Tradesman[®] Cargo Van and SLT Cargo Van



PARTITION

Available for Tradesman Cargo Van and SLT Cargo Van



PARTITION with WINDOW

Available for Tradesman Cargo Van and SLT Cargo Van

RAM PROMASTER CITY®: A GUIDE TO ALL-AROUND CAPABILITY.

THE CLASS-EXCLUSIVE² BI-LINK REAR SUSPENSION

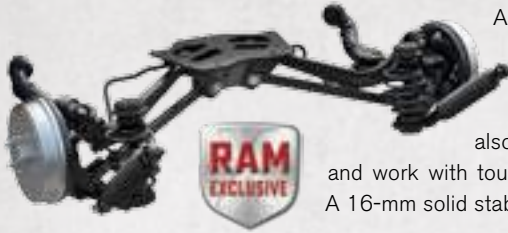

A completely unique feature—and one designed specifically for Ram ProMaster City—is the bi-link rear suspension. This category-unique configuration delivers comfort for passengers, enables confident hauling, and offers enhanced stability. Our engineers employed a steel crossmember with an optimum weight/stiffness ratio to help improve reaction to lateral loads; the technology also contributes to improved handling. The steel, cargo-rated coil springs supply high-fatigue endurance and work with tough telescopic twin-tube hydraulic shocks designed for minimal mass and maximum performance. A 16-mm solid stabilizer bar with optimized torsional stiffness also ensures long-lasting durability.

THE CLASS-EXCLUSIVE² 9-SPEED TRANSMISSION



Featuring Electronic Range Select (ERS), the 9-speed automatic is a major factor in achieving outstanding fuel efficiency. Considered to be superior in gear range, ratio spread and gear transitions to many of its 6-speed counterparts, it dispenses with conventional large-diameter friction discs in favor of dog clutches. With gear disengagement and actuation similar to that of a manual transmission, it uses shorter mid-range gears with near-frictionless operation. Factor in the higher 7th, 8th and 9th transitions, and you've got multiple reasons for the exceptional fuel-efficient performance of every Ram ProMaster City model.



2.4L TIGERSHARK[®] MULTI-AIR² I-4 WITH THE CLASS-EXCLUSIVE² 9-SPEED AUTOMATIC TRANSMISSION

As the only gas-powered 4-cylinder engine in the Ram portfolio, the 2.4L Tigershark takes full advantage of the MultiAir² valve train system. Internal components include a high-pressure die-cast aluminum block, and a forged steel crankshaft with powder-metal forged steel connecting rods and cast-aluminum pistons. Individual oil squirters help keep internal temperatures in the ideal range, and the position of the exhaust manifold helps reduce noise in the engine compartment. Pulse-width modulation technology on the alternator and fuel pump helps contribute to operating efficiency; acceleration is impressive: it's a mere 3.7 seconds from a full stop to 30 mph.

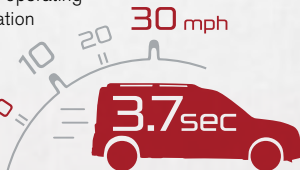

TWIN-TUBE MACPHERSON STRUTS

Twin-tube MacPherson struts are large-diameter (52 mm), engineering that easily supports this best-in-class² GVWR. We also added GVWR-tuned high-performance stamped-steel clamshell-sectioned control arms with a steel crossmember, specifically tuned springs, a solid 26-mm-diameter stabilizer bar with cast-iron knuckles and large-sized coil springs.



RACK AND PINION STEERING WITH FRONT-WHEEL DRIVE

Rack and pinion steering with front-wheel drive shows its advantage in the tight turning radius, a flat-floor cargo area and the easy step-in height. This hydraulic-assist system with premium steering gear is engineered and tuned to meet the rigorous demands of the commercial market; curb-to-curb turns are only 42 feet. The adjustable tilt/telescoping steering column—an unusual convenience in this class—is standard on all models.

RESILIENT FRAME STRENGTH

A solid backbone was a major mandate for this body-frame integral (unibody) design. This chassis employs a stout, integrated frame structure, strategically boxed frame components, multiple crossrails, and robust and comfortable suspension technology. The engineering enables top-level functionality on Cargo Van—**best-in-class² payload and unsurpassed² towing.*** The **best-in-class² GVWR of 5,395 lb** infers outstanding capability, with GCWR rated at a solid and substantial 5,900 lb.



*When properly equipped.

SAFETY AND SECURITY: WE'VE GOT YOU COVERED

YOU'RE CARRYING CARGO, PASSENGERS, OR BOTH. PROTECT ALL OF IT. Every Ram ProMaster City® features one of the most comprehensive and advanced technologies for handling and maneuvering: the **Electronic Stability Control (ESC)⁵ system**. This system integrates the antilock braking system (ABS) with a variety of All-Speed Traction Control technologies that enable all four corners of the vehicle to respond to lateral movement and the steering input from the driver. ESC⁵ helps maintain control under conditions such as wet or snow-covered roads, during tight turns and when the driver must utilize evasive maneuvers to counter the unexpected. Calibrated to engine output, ESC⁵ includes four-channel ABS, Brake/Lock Differential, a full-function All-Speed Traction Control System, Brake Assist, Engine Drag Control, Trailer Sway Control,⁵ Hill Start Assist and Electronic Roll Mitigation.



SEVEN STANDARD AIR BAGS⁶

Few competitive vehicles in the class offer so many. These include dual-stage driver and front-passenger air bags,⁶ side air bag⁶ inflatable curtains, front seat-mounted thorax air bags⁶ **class-exclusive² driver's-side knee air bag⁶** along with dual front seat belt pretensioners and seat belt load limiters.

PARKVIEW⁷ REAR BACK-UP CAMERA⁷

Now standard on every model, the ParkView Rear Back-Up Camera⁷ automatically displays the rear scene in the Uconnect[®] 3 with 5-inch touchscreen display when in Reverse. The on-screen grid lines help when backing up to docks and trailers, or into parking spaces.

PARKSENSE⁷ REAR PARK ASSIST SYSTEM⁷

The available ParkSense Rear Park Assist System⁷ is fast becoming an indispensable asset to keep the driver alert to their surroundings. Activated under 8 mph when in Reverse, it uses audible warnings that increase in intensity as the vehicle nears obstructions to the rear.

TOP-LEVEL CARGO MANAGEMENT

In-roof predrilled receptacles are already in place for numerous aftermarket accessories, including available Roof Rails from Mopar[®]. Molded in color with a Silver finish, they carry a 150-lb max rating and will accommodate a variety of available assets, including Roof Top Cargo Carriers, Bike Carriers, Ski Carriers and Water Sports Carriers. Search mopar.com for a complete inventory.

IN-FLOOR TIE-DOWN RINGS

In-floor tie-down rings (six on Cargo Van; four on Wagon) help secure cargo. They come as standard equipment on every model.

SLEEK AERODYNAMIC DESIGN

Thoroughly wind-tunnel tested, Ram ProMaster City delivers a minimal coefficient of drag (CD) of only 0.30. While this enables an impressively quiet interior, reducing wind resistance acts as a major contributor to the impressive fuel efficiency.

THE HEADLAMP SYSTEM

The headlamp system is high-mounted above common crash zones to help reduce damage (and costs) in the event of a collision. The system includes the Follow Me Home function, illuminating the front of the vehicle via the headlamps for a preset time.



In-floor tie-down rings and seven standard air bags⁶



In-roof predrilled receptacles



Mopar Removable Three Bar Utility Roof Rack

TECHNOLOGY DESIGNED FOR COMFORT AND CONVENIENCE.



UCONNECT® 3 with 5-INCH DISPLAY

- ▶ AM/FM stereo
- ▶ MP3 capability with auxiliary input
- ▶ Integrated Voice Command®
- ▶ Five-inch color touchscreen
- ▶ Four-speaker sound system
- ▶ ParkView® Rear Back-Up Camera⁷



UCONNECT 3 NAV with 5-INCH DISPLAY

- ▶ All features of the Uconnect 3 with 5-inch display
- ▶ GPS Navigation
- ▶ Points-of-Interest accessibility
- ▶ Turn-by-turn Navigation

Properly secure all cargo.

THE RAM PROMASTER CITY® DESIGN TEAM LEFT NOTHING on the table with this interior—an adaptable, large and people-friendly environment that's ideal for one-hour jaunts or weeks spent exploring the country. You'll welcome amenities that range from durable and easy-to-clean surfaces to user-friendly interfaces that represent our values: provide state-of-the-art electronics and communications technologies second to none. Along with that, seating in both models is exemplary, with long-lasting and easy-on-the-eye fabrics designed for maximum comfort.

Storage areas are plentiful; personal space is ample, with generous shoulder and leg room for all. Rear seating in Passenger Wagon comfortably accommodates up to three passengers—and still provides significant cargo room behind the rear seats. Entry and exit through the two oversized side sliding doors on Passenger Wagon are easy and unhindered. No matter which model you're driving, this interior gives you total convenience and functionality. Wagon makes the point with a vehicle-length acoustic headliner and a plush floor carpet that stretches from cab to back door.

OUR SMARTEST CALL WAS TO STUDY THE SMARTPHONE. Your phone now goes far beyond calling, and your radio system in ProMaster City gives you a comparable degree of capability.

Ram ProMaster City features a standard Uconnect 3 with a vibrant 5-inch color touchscreen display and four speakers with Bluetooth® and Integrated Voice Command® Available Uconnect 3 NAV adds GPS Navigation and Points of Interest. Available SiriusXM® Satellite Radio⁹ includes a one-year trial subscription. You're in business or you're with friends and family; with Ram ProMaster City, you're in touch, and in the know—with Uconnect audio system and communications technology.

Uconnect®

SiriusXM®⁹
SATELLITE RADIO



**PASSENGER WAGON: MEET THE
ULTIMATE TEAM PLAYER.**

Properly secure all cargo.

NOT MERELY PEOPLE-FRIENDLY. IT'S EVERYTHING-FRIENDLY. Meet the smartly designed Ram ProMaster City® Passenger Wagon: a working example of adaptable flexibility. From seating configurations to generous front storage to abundant and accessible rear cargo capacity, this robust workhorse meets the need—and it's likely that you'll have room to spare. Whether you manage an office team or your local baseball team, this Wagon delivers top-of-the-line assets for all.

Our engineers addressed seating needs by creating an innovative second-row design that reflects pure practicality and standout versatility. The rear seat is engineered for premium occupant comfort, delivering ample room for three passengers. Also key is the **Fold-and-Tumble rear-seat design that enables nine different configurations** and which enables you to meet virtually any transport need. Dual side doors slide open, and rear doors—with their smart and safety-oriented 60/40 split design with the larger door on the driver's side—are ideal for curbside loading.

Cargo area width maxes out at a huge 57.6 inches, an asset that joins carpeted floors and a full acoustic headliner; the interior is supremely quiet. Finally, front tubular bucket seats with spring suspensions and durable fabrics offer easy in-and-out access, the headrests are adjustable and the seatbacks recline; available manual lumbar support controls (for the driver's seat) and heated surfaces for both front seats finish the list.



TOPPING IT OFF IS OUR TAKE ON ALTERNATIVE TRANSPORTATION.

The layout leaves everything to the imagination and nothing to chance—which is why this roof structure plays a vital role. Rated up to 150 lb, the lightweight aluminum Roof Rails available from Mopar® shown here are just the ticket for handling bikes, extra luggage, sports equipment and more. Ram ProMaster City is pure capability and possibility in motion—which is why the roof is already prepped to accept the rails, and why the rails also accommodate dozens of other Authentic Accessories from Mopar.



LARGE ENOUGH FOR THE WHOLE CREW.

The confined spaces of the traditional family vehicle are long gone. The area behind Passenger Wagon's upright second-row seats is 74.1 cu ft; fold them down, and space opens up to 101.7 cu ft—an area more than twice the volume of a standard washer/dryer combination (around 48 cu ft). And, while standard and available Safety and Security features abound, nothing beats your best buddy keeping an eye out for you and yours.

Properly secure all cargo. Animals should always be safely and properly secured while vehicle is in motion.

Properly secure all cargo.





PEOPLE ALWAYS COME FIRST.
SO WE ADAPT IN SECONDS.



Convenient overhead storage



In-dash storage bin and oversized glove box

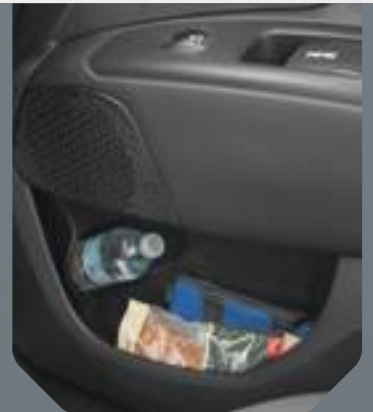

In-door storage bin with angled bottle carrier

Properly secure all cargo.

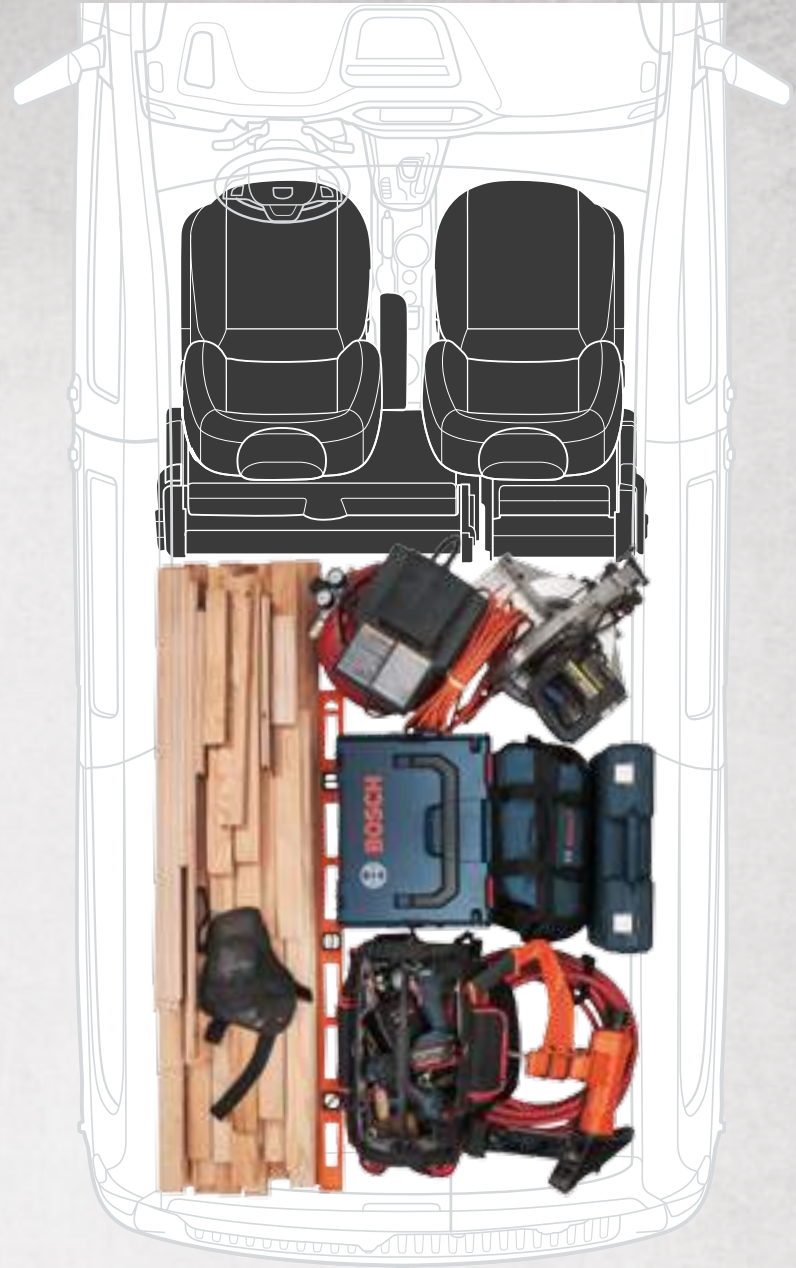

NINE CONFIGURATIONS ALLOW OUTSTANDING VERSATILITY.

Never know what—or who—you'll be hauling next? Ram ProMaster City® Passenger Wagon takes it all in stride. In an instant, you've got 9-way flexibility that's ideal for shuttles, taxis, companies and families: it's a 60/40 split configuration with a Fold-and-Tumble rear-seat design to comfortably seat three, two, or a single occupant. The variety of seating and cargo-carrying formations translates into enormous latitude.

You need storage. This Wagon provides it, with a standard overhead front shelf system running nearly the full length of the roof bow. Angled downward and about five inches high and seven inches deep, it's a handy place for everything from gloves to ice scrapers to notebooks.

The oversized glove box (176.9 cu in) joins a large, open, 12-inch-wide by 4-inch-deep in-dashboard storage bin; concave tray storage in front of the driver is ideal for valuables and personal devices. To that, add multiple storage pockets and trays around the media center, a center console with two cup holders, two 12-volt capped auxiliary power outlets and at-hand USB and auxiliary connections; recharging is smart and intuitive.

This is convenience in motion: ample storage space, instant configurability, occupant-friendly seating and abundant cargo-carrying capacity. In every respect, Ram ProMaster City delivers a smartly engineered interior designed to meet every personal and business need.



Properly secure all cargo.

A NEW DEFINITION OF UPWARD MOBILITY.

RAM PROMASTER CITY®: A MOVING EXAMPLE OF OUR COMMITMENT TO AUTOMOBILITY. When you design and build a vehicle with this level of adaptability, you create a means to deliver a new level of independent travel. When it comes to mobility-minded upfits and personal customization, few deliver like the Ram ProMaster City models. The expansive side door openings provide huge, unimpeded access, and the 60/40 split rear doors can easily accommodate a wheelchair with occupant. The in-floor D-rings on all models (four on Wagon and six on Cargo Van), ensure secure anchoring for wheelchairs and accessories, while Passenger Wagon adds additional comfort measures (like optional power second-row windows and variable seating dynamics) topped off with the welcome quietness that comes from a carpeted cabin throughout the entire vehicle.



SMART THINKING ENABLES EMPOWERMENT

As these two customized solutions illustrate, converting a Ram ProMaster City for wheelchair or disabled access is a designed-in advantage. Far left, controlled by third-party aftermarket electrohydraulic controls, this user-friendly swing-out front seat shows how convenience becomes freedom of movement. Near left: An upfit that utilizes an aftermarket lift for wheelchairs or scooters; the rear area is large enough to store it after use.

It all comes together for all the right reasons: impressive GVWR, huge and adaptable interior, and generous door openings to the side and rear.

Automobility upfit is aftermarket only. Properly secure all cargo.



IT JUST KEEPS GETTING BETTER.

MOPAR.: TOTAL CONVENIENCE AND CUSTOMIZATION.

While Ram ProMaster City® delivers all the reliability of a commercial-grade vehicle, our thinking isn't limited. Things like resale value, aesthetics and ease-of-operation count big.

Our engineers worked with our colleagues at Mopar® to incorporate dozens of practical ideas and designs to maximize performance, convenience and safety. Authentic Accessories from Mopar offer complete solutions to make life easier, protect the vehicle's body, expand storage and ramp up overall capability. Get the big picture at your Ram ProMaster City dealer, or do an online investigation. It's all at mopar.com



All-Weather Floor Mats

Roadside Safety Kit. DOT-Compliant



Cargo Tote



Premium Carpet Cargo Mat

Trailer Tow Wiring Harness*



Cargo Area Security Cover



Hitch Receiver*



LED Cargo-Area Lights



Molded Splash Guards



Three Bar Utility Roof Rack (shown with PVC Carriers*)

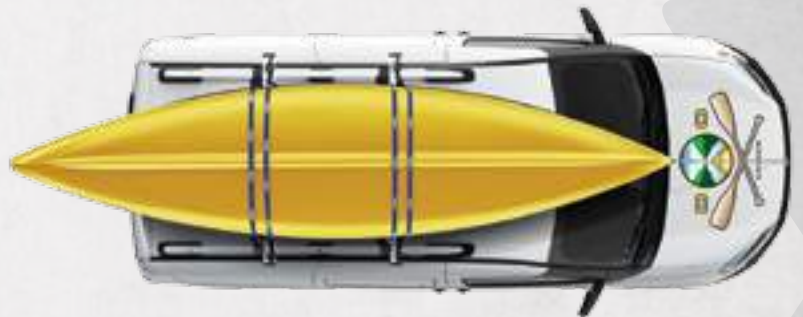

Side Rails with Adjustable Crossbars and Roof-Mount Canoe Carrier†



Side Rails with Adjustable Crossbars and Roof-Mount Ski and Snowboard Carrier†



Side Rails with Adjustable Crossbars and Roof-Top Cargo Box†

*Check Owner's Manual for hitch type, load capacity and heavy-duty equipment required. Do not exceed rated tow capacity of the vehicle as equipped. Trailer may require items not supplied by Mopar. †Not available from Mopar; sold separately. ‡Carrier mounts to the Mopar Side Rails with Adjustable Crossbars or Mopar Three Bar Utility Roof Rack; accessories are sold separately. Properly secure all cargo.

TRADESMAN® CARGO VAN

TRADESMAN SLT CARGO VAN

WAGON

WAGON SLT



Two-person seating



Two-person seating



Five-person seating



Five-person seating



RAM PROMASTER CITY® BUYER'S GUIDE

	Tradesman Cargo Van	Tradesman SLT Cargo Van	Wagon	Wagon SLT
CPOS PACKAGE	2TC	2TD	2TA	2TB
ENGINE AND TRANSMISSION				
2.4L TIGERSHARK® MULTI-AIR® 2 I-4 WITH 9-SPEED AUTOMATIC	24C	24D	24A	24B
MECHANICAL FEATURES				
ALTERNATOR – 160-amp	•	•	•	•
BATTERY – 700-amp maintenance-free	•	•	•	•
BRAKES – 4-wheel antilock	•	•	•	•
FUEL TANK – 16-gallon	•	•	•	•
ELECTRONIC VEHICLE TRACKING SYSTEM (EVTS) (by Mopar®)	0	0	0	0
UPFIT INTERFACE CONNECTOR (included with Taxi Cab Package on Wagon; late availability)	0	0	0/P	0
EXTERIOR FEATURES				
BODYSIDE MOLDING – Black	•	•	•	•
BUMPERS – Front and rear Black	•	•	•	•
– Front and rear in body-color		•	•	•
DAYTIME RUNNING LAMPS	0	0	0	0
DOORS – Rear hinged doors with fixed glass and sliding side doors with vented glass (Wagon models only)			•	•
– Rear hinged doors with fixed glass, sliding side doors with vented glass (Cargo Van models only; includes side window grates with no partition)	0	0		
– Rear hinged doors with fixed glass	0	0	•	•
– Side sliding right door with vented glass (passenger side only); packaged with rear hinged doors with fixed glass and sliding side doors with vented glass (includes window grate with no partition)	0/P	0/P		
– Side sliding left door with vented glass (driver side only); packaged with rear hinged doors with fixed glass and sliding side doors with vented glass (includes window grate with no partition)	0/P	0/P		
– Rear doors with 180-degree opening	•	•	•	•
– Side and rear doors with solid panels	•	•	•	•
FOG LAMPS – Front (requires Lights and Wheels Group)		P		P
GLASS – Deep-tint (not available on Cargo Van models with side sliding rear doors with solid panels)	0	P	0	•
HEADLAMPS – Halogen	•	•	•	•
MIRRORS – Remote, manual-adjustable	•		•	
– Power-adjustable, folding, heated with body-color caps		•	•	•
ROOF RACK – Side Rails (by Mopar)	0	0	0	0
ROOF RACK CROSSBARS (requires Roof Rack Side Rails) (by Mopar)	0	0	0	0
CROSSBARS – Three Bar Utility (not available with Roof Rack Side Rails) (by Mopar)	0	0	0	0
SPLASH GUARDS – Set (by Mopar)	0	0	0	0
TIRES – 215/55R16XL BSW All-Season	•	•	•	•
WHEELS – 16-inch steel painted Silver with center cap	•	•	•	•
– 16-inch steel painted Black with full-painted Silver wheel covers (included with Taxi Cab Package)	0	•	0/P	•
– 16-inch aluminum (requires Lights and Wheels Group)		P		P
– Full-Size Spare Tire	•	•	•	•
– Full-Size Spare Tire and Inflator Kit	0	0	0	0
– Tire Service Kit (includes tire sealant and portable air compressor)	•	•	•	•

• = Standard 0 = Optional P = Part of Package

RAM PROMASTER CITY[®] BUYER'S GUIDE

	Tradesman Cargo Van	Tradesman SLT Cargo Van	Wagon [®]	Wagon SLT
INTERIOR FEATURES				
AIR CONDITIONING	•	•	•	•
DOOR LOCKS – Power, speed-sensitive	•	•	•	•
FLOOR MATS – Front and Rear Carpet (by Mopar [®])			0	0
– Front and Rear Slush (by Mopar)			0	0
– Front Carpet (by Mopar)	0	0		
– Front Slush (by Mopar)	0	0		
LIGHTING – Incandescent map/courtesy/cargo lamps	•	•	•	•
– LED Cargo-Area Lighting (by Mopar)	0	0		
SEATS – 60/40 Fold-and-Tumble three-person rear bench			•	•
– Cloth low-back bucket with manual adjuster	•		•	
– Heated front (included with Popular Equipment Group)		P		P
– Premium cloth bucket with driver-side manual lumbar and height adjusters		•		•
– Premium vinyl bucket with driver-side manual lumbar and height adjusters and passenger-side manual lumbar adjuster (included with Taxi Cab Package on Wagon; late availability)	0	0	0/P	0
SPEED CONTROL	0	•	0	•
STEERING COLUMN – Tilt/telescoping	•	•	•	•
STEERING WHEEL – Base	•	•	•	•
– Leather-wrapped with audio controls (included with Uconnect [®] 3 NAV with 5-inch display; requires speed control)	P	•	P	•
WINDOWS – Front, power with one-touch up/down	•	•	•	•
– Second-row power (included with Popular Equipment Group and Taxi Cab Package)		P	P	P
UCONNECT/MULTIMEDIA				
MOPAR WEB WIFI HOTSPOT ⁹	0	0	0	0
UCONNECT 3 WITH 5-INCH DISPLAY – Includes AM/FM, Integrated Voice Command ⁶ with Bluetooth [®]	•	•	•	•
UCONNECT 3 NAV WITH 5-INCH DISPLAY AND NAVIGATION – Includes AM/FM/NAV and leather-wrapped steering wheel with audio controls on Tradesman Cargo Van and Wagon models	0	0	0	0
SIRIUSXM [®] SATELLITE RADIO ⁹	0	0	0	0
SPEAKERS – Four	•	•	•	•
– Six (packaged with Popular Equipment Group)				P
SAFETY AND SECURITY				
AIR BAGS ⁵ – Front driver and passenger	•	•	•	•
– Driver inflatable knee bolster	•	•	•	•
– Supplemental front-seat side	•	•	•	•
– Supplemental side-curtain for 1st and 2nd row			•	•
– Supplemental side-curtain for 1st row	•	•		
DOT-COMPLIANT ROADSIDE SAFETY KIT (by Mopar)	0	0	0	0
ELECTRONIC STABILITY CONTROL (ESC) ⁵ – Includes All-Speed Traction Control, Brake Assist, Brake-Lock Differential, Electronic Roll Mitigation, Hill Start Assist and Trailer Sway Damping ⁵	•	•	•	•
PARKSENSE [®] REAR PARK ASSIST ⁷	0	0	0	0
PARKVIEW [®] REAR BACK-UP CAMERA ⁷	•	•	•	•
REMOTE KEYLESS ENTRY	•	•	•	•
REMOTE START SYSTEM (by Mopar)	0	0	0	0
TIRE PRESSURE MONITORING (TPM) SYSTEM – Warning lamp	•	•	•	•
PACKAGES/EQUIPMENT GROUPS				
CARGO PARTITION PACKAGE – No window (includes rear wall trim)	0	0		
– With window (includes rear wall trim)	0	0		
LIGHTS AND WHEELS GROUP – Includes front fog lamps and 16-inch aluminum wheels		0		0
POPULAR EQUIPMENT GROUP – Includes heated front seats, 2nd-row power window and six speakers (Wagon models); not available with sliding side and rear doors with solid panels on Cargo Van models		0		0
REAR WIPER/WASHER/DEFROSTER GROUP – Includes rear window defroster and rear window wiper/washer (packaged with Taxi Cab Package; requires deep-tint sunscreen glass; not available with sliding side and rear doors with solid panels)	0	0	0/P	0
TAXI CAB PACKAGE – Includes Rear Wiper/Washer/Defroster Group, premium vinyl bucket seats, upfit interface connector, two additional key fobs, Black power-heated power-adjustable mirrors, 2nd-row power windows and 16-inch steel painted Black wheels with full-painted Silver wheel covers (late availability)			0	
TRAILER TOW GROUP – Includes Class III hitch receiver with four- and seven-pin wiring harness	0	0	0	0

• = Standard 0 = Optional P = Part of Package



2.4L TIGERSHARK® MULTIAIR 2 I-4

Mated to the **class-exclusive² 9-speed automatic transmission**, Ram ProMaster City® delivers **best-in-class² horsepower and torque**, along with unsurpassed² towing*—up to 2,000 lb on Cargo Van. Calibrated for wallet-friendly 87-octane gasoline, this in-line 4-cylinder powerplant also stands out with a **best-in-class¹¹ driving range with standard motor: up to 448 miles[†] per tank**. Given all the impressive figures and backed with a comprehensive 5-Year/60,000-Mile Powertrain Limited Warranty;⁴ these are tough commercial vehicles designed with low costs of operation in mind.

178 HORSEPOWER 174 LB-FT OF TORQUE

5YR/60,000MI⁴
POWERTRAIN LIMITED WARRANTY

SPECIFICATIONS

2.4L TIGERSHARK MULTIAIR 2 I-4

HORSEPOWER	178 hp @ 6,400 rpm
TORQUE	174 lb-ft @ 3,800 rpm
CONFIGURATION	In-line four-cylinder
DISPLACEMENT	144 cu in / 2360 cc
BORE x STROKE	3.46 x 3.82 in / 88.0 x 97.0 mm
BLOCK MATERIAL	Aluminum
CYLINDER HEAD MATERIAL	Aluminum
AIR INDUCTION	Naturally aspirated
VALVE TRAIN	Chain-driven DOHC, 16-valve
FUEL DELIVERY	Sequential, multiport injection
RECOMMENDED FUEL	Unleaded regular (87 octane)
COMPRESSION RATIO	10.0:1
ALTERNATOR	160-amp
OIL CAPACITY	5.5-qt



*When properly equipped. †EPA estimated 21 mpg city/28 mpg hwy and 16-gallon fuel tank. Actual results may vary.

SPECIFICATIONS

PAYLOAD/TOWING

(maximum capacities; in pounds)

	TRADESMAN® CARGO VAN	TRADESMAN SLT CARGO VAN	WAGON	WAGON SLT
GVWR	5,395	5,395	5,395	5,395
GCWR	5,900	5,900	5,900	5,900
CURB WEIGHT	3,512	3,512	3,682	3,682
MAXIMUM PAYLOAD†	1,883	1,883	1,713	1,713
MAXIMUM TOWING*	2,000	2,000	1,867	1,867

Trailer Weight Rating and Tow Vehicle Trailing Weight are calculated as specified in SAE J2807. Driver and passenger weight = 300 lb. Trailer Equipment Weight = 50.7 lb for conventional hitch.
*When properly equipped. †Maximum payload based on body model, GVWR class. Specifications subject to change. See dealer for most up-to-date information.

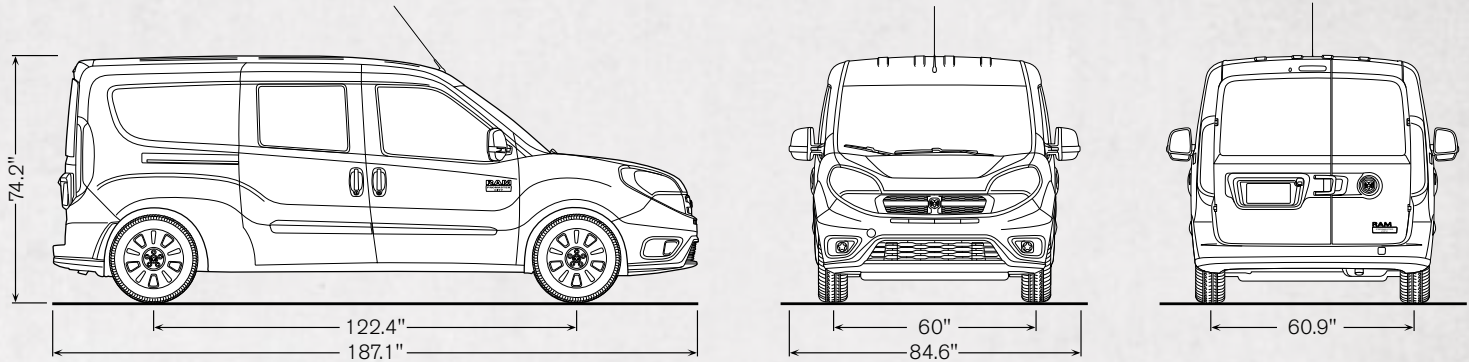

DIMENSIONS

(in inches unless otherwise noted)

	TRADESMAN CARGO VAN	TRADESMAN SLT CARGO VAN	WAGON	WAGON SLT
CARGO HEIGHT	51.8	51.8	48.7	48.7
CARGO VOLUME (cu ft) (behind 2nd-row seats on Wagon / 2nd-row seats folded on Wagon)	131.7	131.7	74.1 / 101.7	74.1 / 101.7
DOOR OPENING HEIGHT – REAR CARGO	47.4	47.4	46.4	46.4
– SIDE SLIDING	43.6	43.6	42.7	42.7
DOOR OPENING WIDTH – REAR CARGO	48.6	48.6	48.6	48.6
– SIDE SLIDING	25.8	25.8	21.2	21.2
HEAD ROOM – FIRST-ROW	45.8	45.8	45.8	45.8
– SECOND-ROW	–	–	44	44
HEIGHT – OVERALL	74.2	74.2	74.2	74.2
HIP ROOM – FIRST-ROW	52.8	52.8	52.8	52.8
– SECOND-ROW	–	–	59.2	59.2
LEG ROOM – FIRST-ROW	40.8	40.8	40.8	40.8
– SECOND-ROW	–	–	36.8	36.8
LENGTH – LOAD FLOOR (behind 2nd-row seats on Wagon / 2nd-row seats folded on Wagon)	87.2	87.2	54.7 / 69.2	54.7 / 69.2
LENGTH – OVERALL BODY	187.1	187.1	187.1	187.1
REAR DOOR LIFT-IN HEIGHT	23.3	23.3	23.8	23.8
SIDE DOOR STEP-IN HEIGHT	21.5	21.5	19.3	19.3
WHEELBASE	122.4	122.4	122.4	122.4
WIDTH – BETWEEN WHEEL WELLS	48.4	48.4	48.4	48.4
– MAXIMUM BETWEEN SIDE PANELS	60.4	60.4	57.6	57.6
– VEHICLE (including mirrors)	84.6	84.6	84.6	84.6

EXTERIOR COLORS



Silver Metallic



Quartz Gray Metallic



Blue Night Metallic



Black Metallic



Bright White



Broom Yellow



Bright Red



Deep Red Metallic

WHEELS



16-inch Steel Wheel painted Silver with Center Cap
Standard on Tradesman® Cargo Van/Wagon



16-inch Steel Wheel with full-painted Silver Wheel Cover
Standard on SLT Cargo Van/Wagon
Available on Tradesman Cargo Van/Wagon
Packaged with Taxi Cab Package*



16-inch Aluminum Wheel
Available on SLT Cargo Van/Wagon

INTERIOR FABRICS

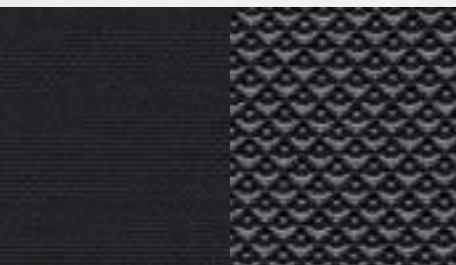

Black Cloth
Standard on Tradesman Cargo Van/Wagon



Premium Black Cloth
Standard on SLT Cargo Van/Wagon



Premium Black Vinyl*
Available on Tradesman and SLT Cargo Van/Wagon
Packaged with Taxi Cab Package

*Late availability

BUSINESS LINK

The fast lane for small business.

THE DEALER NETWORK FOR YOUR BUSINESS.

Your **BusinessLink** dealer is committed to providing you, the small business owner, with the vehicle support you need for your business, from servicing all makes and models of your existing vehicles to selling you the right vehicles needed to perform the work that you do. Your **BusinessLink** dealer provides priority service because we know downtime is costing you money. Your **BusinessLink** dealer has sales

professionals trained to properly "job-rate" the right vehicle for your work application along with providing commercial finance options. New vehicle sales to qualified small business owners also receive a free alternate transportation contract, in the event your vehicle is in for service.

Membership in the **BusinessLink** program is free. Membership helps us to identify you as a small business owner so we can provide you with both the service you deserve and update you with offers that can help reduce the cost of doing business. Ask your **BusinessLink** dealer to register today.

BusinessLink has you covered.

- ▶ Full Range of FCA Commercial Vehicles
- ▶ Free Membership
- ▶ Priority Service
- ▶ Extended Service Hours
- ▶ Dedicated Staff of Commercial Vehicle Experts
- ▶ Free Alternate Transportation
- ▶ Generous Incentives
- ▶ Expertise in Commercial Financing Options
- ▶ 24/7 Towing Service Available

For more information, log on to FCAUSFLEET.COM or call us toll-free at 877-2THELINK (877-284-3546).

ON THE JOB

INCENTIVES FOR SMALL BUSINESSES.

Running a business presents plenty of challenges. Like cutting costs, not corners. Like saving time and money and eliminating hassles. The **ON THE JOB**¹² commercial incentive program provides assistance in customizing and servicing your business vehicles.

ON THE JOB¹² allowances make your business more profitable!

- ▶ **NO-EXTRA-CHARGE** 2-Year Gas/4-Year Diesel Lube-Oil-Filter Allowance
- ▶ **UP TO \$1,000** Commercial Graphics Program Allowance
- ▶ **UP TO \$1,000** Commercial Equipment/Upfit Allowance
- ▶ **\$300 - \$1,000** Allowance on Select Mopar[®] Service Contracts

See your dealer for specific program rules and details, log on to FCAUSFLEET.COM or call us toll-free at 877-ONTHEJOB (877-668-4356).

A commercial line of credit from Chrysler Capital is ideal for qualified business customers looking for a flexible, easy way to manage growing vehicle needs. Chrysler Capital streamlines the process. With prequalification, you're ready to buy a vehicle when you need it. Ask your **BusinessLink** dealer for details.

CHRYSLER CAPITAL

RAM OUTFITTER

RAMTRUCKS.COM/OUTFITTER



1 Based on best-in-class cargo capacity, best-in-class payload and best-in-class fuel efficiency. 2 Based on latest available competitive information. Class is Small Commercial Van segment. 3 Based on latest available competitive information. Class is Small Commercial Van segment. Estimated 28 hwy mpg, 2.4L automatic 9-speed transmission. Actual results may vary. 4 Transferable. See dealer for complete details and a copy of the 5-Year/60,000-Mile Powertrain Limited Warranty. 5 No system, no matter how sophisticated, can repeal the laws of physics or overcome careless driving actions. Performance is limited by available traction, which snow, ice and other conditions can affect. When the ESC warning lamp flashes, the driver needs to use less throttle and adapt speed and driving behavior to prevailing road conditions. Always drive carefully, consistent with conditions. Always wear your seat belt. 6 The Advanced Front Air Bags in this vehicle are certified to the new U.S. Federal regulations for Advanced Air Bags. Children 12 years old and younger should always ride buckled up in a rear seat. Infants in rear-facing child restraints should never ride in the front seat of a vehicle with a passenger front air bag. All occupants should always wear their lap and shoulder belts properly. 7 Always look before proceeding, electronic drive aid is not a substitute for conscientious driving; always be aware of your surroundings. 8 Requires a mobile phone equipped with the Bluetooth Hands-Free Profile. Visit UconnectPhone.com for system and device compatibility. 9 SiriusXM audio and data services each require a subscription sold separately or as a package by Sirius XM Radio Inc. Your SiriusXM service will automatically stop at the end of your trial unless you decide to subscribe. **If you decide to continue service after your trial, the subscription plan you choose will automatically renew thereafter and you will be charged according to your chosen payment method at then-current rates.** Fees and taxes apply. To cancel, you must call SiriusXM at 1-866-635-2349. See SiriusXM Customer Agreement for complete terms at www.siriusxm.com. All fees and programming subject to change. Not all vehicles or devices are capable of receiving all services offered by SiriusXM. Current information and features may not be available in all locations or on all receivers. 10 WiFi subscription required. Vehicle must be properly equipped and in active and usable cellular range for WiFi usage. WiFi Hotspot does not enable direct communication between multiple in-vehicle devices. Factors affecting the performance of WiFi Hotspot include: cellular network, signal strength and quality, time of day, number of channels used by the service provider, type of connection, number of clients using WiFi Hotspot and client device. This feature is not intended for use by the driver while the vehicle is in motion. Always drive safely. 11 Based on latest available competitive information. Class is Small Commercial Van segment. EPA estimated 28 hwy and 16-gallon fuel tank, 2.4L automatic 9-speed transmission. Actual mileage may vary. 12 ON THE JOB is a retail incentive program; see your dealer for official rules. Inquire about eligibility by calling 877-ONTHEJOB or by logging on to fcausfleet.com. The purchaser or lessee must be a qualified commercial customer for more than 30 days prior to the date of the vehicle purchase. An official ON THE JOB Customer Acknowledgment Form must be signed by the customer (provided by the dealer).

©2017 FCA US LLC. All Rights Reserved. Ram, Mopar, Automobility Program, the BusinessLink design, ParkSense, ParkView, the Ram's Head logo, Ram ProMaster City, Tigershark, Tradesman and Uconnect are registered trademarks, and the On The Job design is a trademark of FCA US LLC. Chrysler Capital is a registered trademark of FCA US LLC and licensed to Santander Consumer USA Inc. MultiAir is a registered trademark of C.R.F. Società Consortile per Azioni, used under license by FCA US LLC.

Bluetooth is a registered trademark of Bluetooth SIG, Inc. Sirius XM Connected Vehicles Services Inc. Sirius, XM and SiriusXM and all related marks and logos are trademarks of Sirius XM Radio Inc. Bosch is a registered trademark of Robert Bosch GmbH. Facebook and logo are registered trademarks of Facebook, Inc. The Twitter logo is a service mark of Twitter, Inc. The YouTube logo is a registered trademark of Google Inc. Instagram and logo are registered trademarks of Instagram, Inc. Bontrager is a registered trademark of Trek Bicycle Corporation. Thule is a registered trademark of Thule, Inc. Katerack is a registered trademark of Dejana Truck & Utility Equipment Co. All rights reserved. Grizzly is a trademark of Grizzly Coolers LLC.

About this catalog: since the time of printing, some of the information you'll find in this catalog may have been updated. Ask your dealer for details. Some of the equipment shown or described throughout this catalog may be available at extra cost. Specifications, descriptions, illustrative materials and all competitive comparisons contained herein are as accurate as known at the time this publication was approved for printing. FCA US LLC reserves the right to discontinue models at any time or change specifications without notice or without incurring obligation. Options may be required in combination with other options. For the price of the model with the equipment you desire, or verification of specifications contained here, see your Ram ProMaster City dealer.



Join our community on Facebook, submit your photos on Instagram, follow us on Twitter and check us out on YouTube.



RAM ZONE

Join fellow Ram enthusiasts and tell your story by posting comments, participating in discussions and sharing your photos and videos.



HWY FUEL ECONOMY*

28 MPG HWY*
2.4L TIGERSHARK™ I-4

*EPA estimated 21 mpg city/28 mpg hwy. Actual results may vary.

131.7-CU FT
CARGO CAPACITY*

Cargo Van



178 HP, 174 LB-FT OF TORQUE*
2.4L TIGERSHARK
MULTIAIR™ 2 I-4



48.4-INCH
CARGO WIDTH
between wheel wells²

1,883-LB
MAXIMUM PAYLOAD²

Cargo Van



BI-LINK REAR
SUSPENSION²
OUTSTANDING COMFORT,
ENHANCED STABILITY



— AMERICA'S — MOST EFFICIENT — WORK VAN¹ —



NINE-SPEED
AUTOMATIC
TRANSMISSION*

Unsurpassed
2,000-LB
MAXIMUM TOWING*

Cargo Van; when properly equipped.



Convenient

60/40 SPLIT
REAR DOORS
that open 180 degrees

Designed to accept a standard pallet.

0-30 MPH IN 3.7 SEC



Up to
10,000-MILE
ENGINE OIL
CHANGE INTERVALS

UCONNECT™ 3
WITH **5-INCH**
TOUCHSCREEN DISPLAY

Standard



RAM
COMMERCIAL

RAMTRUCKS.COM/PROMASTERCITY