

The 2006
BMW 3 Series Sedan



The Ultimate
Driving Machine®

325i
325xi
330i
330xi







Motor is our middle name.

Suspension of disbelief.





So athletic, they call it a sports sedan.



At the center of everything, there's driving joy.



Clean, uncluttered and elegant.



xDrive gives you the power to master virtually anything the road throws at you.

BMW's intelligent xDrive¹ all-wheel drive system takes all-road traction to new heights, while maintaining the 3 Series' legendary agility. On smooth, dry roads, the 325xi and 330xi have the feel of their rear-wheel drive stablemates. But hit a wet downhill curve, for instance, and even before wheelspin can occur, the xDrive system immediately recognizes any need for a change in power distribution. Almost instantaneously, xDrive can send more torque to the front axle in order to enhance stability. Should one wheel on an axle spin faster than the other, the brakes can be applied individually, as needed, to bring all wheels back in sync. At any given moment, xDrive is working hard, shifting drive power, reducing over- or understeer, enhancing agility, and providing the best possible traction.

¹xDrive standard in 325xi and 330xi; not available in 325i and 330i.

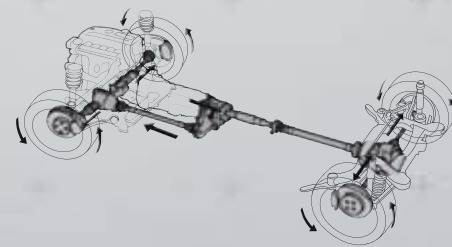

By using readings from the DSC (Dynamic Stability Control) sensors and the gas pedal, xDrive permanently monitors the car's driving condition. This data is then used to vary power distribution between the two axles, ensuring agile, neutral and forgiving handling at all times.

Equipment



■/□ **Xenon Adaptive Headlights** provide brilliant clarity of the road ahead and to the side at night and in conditions with poor visibility. The dynamic auto-leveling feature adjusts for varying passenger and cargo loads, helping to keep headlight glare out of the eyes of oncoming drivers. BMW Adaptive Headlights provide optimum road illumination around corners, thanks to an electromechanical control system that directs the headlights into and around the bend as soon as the vehicle begins cornering. (std. on 330i/330xi; opt. on 325i/325xi)



■ **Adaptive Brake Lights** increase vehicle visibility and signal the intensity of your braking action.



■ **Halogen free-form foglights**, integrated into the deep front spoiler, enhance your margin of safety in bad visibility. Ellipsoid free-form technology ensures even light distribution on the road.



■ BMW's **distinctive front kidney-shaped grille** features a chrome surround. The vertical slats on the 330i/330xi grille are chrome; the 325i/325xi has black slats.



■ **Roof rail clips and grooves** are designed for the BMW Accessory roof rail system, holding it perfectly in place.

Equipment



□ **Star Spoke (Style 162) light-alloy wheels and run-flat¹ performance tires.**² In front: 18 x 8.0 wheels and 225/40R-18 tires; in back: 18 x 8.5 wheels and 255/35R-18 tires.³ (included in 330i Sport Package; opt. in 330xi, requires optional Sport Package)



■ / □ **17 x 8.0 Star Spoke (Style 159) light-alloy wheels with 225/45R-17 run-flat¹ all-season tires.** (std. on 330i/330xi; included in 325xi Sport Package)



□ **17 x 8.0 Star Spoke (Style 158) light-alloy wheels with 225/45R-17 run-flat¹ all-season tires.** (included in 330xi Sport Package)



■ **16 x 7.0 Double Spoke (Style 156) light-alloy wheels with 205/55R-16 run-flat¹ all-season tires.** (std. on 325i/325xi)



□ **Double Spoke (Style 161) light-alloy wheels and run-flat¹ performance tires.**² In front: 17 x 8.0 wheels and 225/45R-17 tires; in back: 17 x 8.5 wheels and 255/40R-17 tires.³ (included in 325i Sport Package; opt. in 325xi, requires optional Sport Package)

¹Run-flat tires do not come equipped with a spare tire.

²Performance tires not recommended for driving in ice and snow.

³Due to low-profile tires, wheels, tires and suspension parts are more susceptible to road hazard and consequential damages.

Equipment



■ **Three-spoke leather-wrapped multi-function steering wheel** lets you keep both hands on the wheel while adjusting various comfort functions, such as changing the radio, CD selections and volume. Optional Voice Command (included with optional on-board navigation system) can be used to change radio stations and audio selection, navigation system destinations, and (accessory) telephone entries.



□ **6-speed STEPTRONIC automatic transmission** provides a choice of three modes: “Drive,” which incorporates BMW’s Adaptive Transmission Control; “Sport” automatic, for a more dynamic shift pattern; and STEPTRONIC automatic, for the hands-on control of a manual without using a clutch. (Shown with iDrive, which is included with optional on-board navigation system)



■ **6-speed manual transmission** delivers a precise, athletic feel. Its responsiveness is due, in part, to the enhanced synchronization of shifts from neutral to each gear. A shortened shift lever and “throw” add to the sporty feel of the gearbox. The sixth gear drops revs at highway speeds for smooth cruising. (Shown with iDrive, included with optional on-board navigation system)



■ **Two cupholders** are integrated into the dashboard, and can easily be retracted when not in use. (The driver’s cupholder is not shown.) Two cupholders are also provided in the rear-seat center console for rear-seat passengers.





















■ The **on-board computer** with Check Control provides valuable feedback on the vehicle’s operating status: oil level indicator and distance to next service appointment/oil change, as well as other detailed information, such as spark plug and micro-filter status. It also provides travel information – travel range on remaining fuel, external temperature, and more.



■ **Rain sensor** uses infrared light to measure the amount of rain. When the wipers are in the “intermittent” mode, the rain sensor automatically adjusts the windshield wiping interval as needed.

Automatic headlight control (not shown), included with rain sensor, activates headlights by means of a sensor that responds to darkness.

Combinations

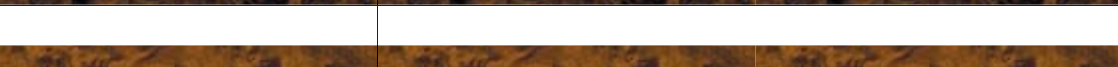
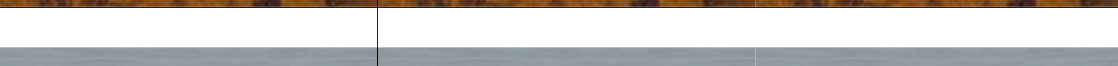
Materials	Leatherette ¹		Leather ²			
	Beige	Black	Beige	Gray	Terra	Black
Upholstery colors						
Exterior colors						
300 Alpine White Non-metallic		•	•	•	•	•
438 Electric Red Non-metallic		•	•	•	•	•
668 Black Non-metallic		•	•	•	•	•
354 Titanium Silver Metallic ³		•	•	•	•	•
A34 Arctic Metallic ³		•	•	•	•	•
A22 Sparkling Graphite Metallic ³		•	•	•	•	•
A23 Sonora Metallic ³		•	•	•	•	•
A07 Mystic Blue Metallic ³		•	•	•	•	•
A35 Monaco Blue Metallic ³		•	•	•	•	•
A41 Barrique Red Metallic ³		•	•	•	•	•
A43 Deep Green Metallic ³		•	•	•	•	•
475 Black Sapphire Metallic ³		•	•	•	•	•
Interior trims						
4AB Burl Walnut Wood ⁴						
4AC Poplar Natural Wood ⁵						
4AD Brushed Aluminium ⁵						
<p>¹ Leatherette upholstery: Standard in 325i/325xi and 330i/330xi.</p> <p>² Leather upholstery: Optional, and included in optional 325i/325xi and 330i/330xi Premium Packages.</p> <p>³ Metallic exterior paint is optional.</p> <p>⁴ Burl Walnut Wood trim: Standard in 325i/325xi and 330i/330xi.</p> <p>⁵ Poplar Natural Wood trim and Aluminum trim: No-cost options in 325i/325xi and 330i/330xi.</p>						

Equipment

Performance and efficiency	325i	325xi	330i	330xi
3.0-liter dual overhead cam (DOHC), 24-valve inline 215-horsepower 6-cylinder engine with composite magnesium/aluminum engine block, Valvetronic, and Double VANOS steplessly variable valve timing	●	●		
3.0-liter dual overhead cam (DOHC), 24-valve inline 255-horsepower 6-cylinder engine with composite magnesium/aluminum engine block, Valvetronic, and Double VANOS steplessly variable valve timing			●	●
3-stage air intake manifold			●	●
Electronic throttle control	●	●	●	●
6-speed manual transmission	●	●	●	●
6-speed STEPTRONIC automatic transmission with Adaptive Transmission Control	○	○	○	○

Handling, ride and braking	325i	325xi	330i	330xi
Dynamic Stability Control (DSC), including Brake Fade Compensation, Start-off Assistant, Brake Drying, and Brake Stand-by features, with Dynamic Traction Control (DTC)	●	●	●	●
Extensive aluminum componentry, including front suspension components (forged-aluminum lower arms, steering knuckle); subframe; steering rack; and brake components	●		●	
xDrive all-wheel-drive system		●		●
Double-pivot type front suspension with dual forged-aluminum lower arms	●	● ¹	●	● ¹
5-link rear suspension with cast-aluminum upper transverse arms	●	●	●	●
Front and rear anti-roll (stabilizer) bars	●	●	●	●
Twin-tube gas-pressure shock absorbers	●	●	●	●
4-wheel ventilated anti-lock disc brakes with Dynamic Brake Control (DBC)	●	●	●	●
Engine-speed-sensitive, variable-assist power steering	●	●	●	●
Active Steering with Servotronic power assist	○		○	
Sport suspension calibration	□		□	

Exterior	325i	325xi	330i	330xi
16 x 7.0 Double Spoke (Style 156) light-alloy wheels, 205/55R-16 run-flat ² all-season tires	●	●		
17 x 8.0 Star Spoke (Style 159) light-alloy wheels, 225/45R-17 run-flat ² all-season tires		□	●	●
Double Spoke (Style 161) light-alloy wheels, 17 x 8.0 front, 17 x 8.5 rear; 225/45R-17 front, 255/40R-17 rear run-flat ² performance tires ³	□	○ ⁴		
17 x 8.0 Star Spoke (Style 158) light-alloy wheels, 225/45R-17 run-flat ² all-season tires				□
Star Spoke (Style 162) light-alloy wheels, 18 x 8.0 front, 18 x 8.5 rear; 225/40R-18 front, 255/35R-18 rear run-flat ² performance tires ³			□	○ ⁴
Flat Tire Warning Indicator	●	●	●	●
Halogen high- and low-beam headlights	●	●		
Xenon Adaptive Headlights with auto-leveling	○	○	●	●
Halogen free-form front foglights	●	●	●	●
Retractable, high-intensity headlight washers	★	●	★	●
Heated dual power mirrors and heated windshield washer jets	●	●	●	●
Metallic paint	○	○	○	○

- Standard
- Optional
- Included in optional Sport Package
- ◇ Included in optional Premium Package
- ★ Included in optional Cold Weather Package

¹ 325xi and 330xi have steel lower arms and a steel subframe, plus an aluminum thrust plate.

² Run-flat tires do not come equipped with spare tire.

³ Due to low-profile tires, please note: wheels, tires and suspension parts are more susceptible to road hazard and consequential damages. Performance tires are not recommended for driving in snow and ice.

⁴ Sport Package required.

Equipment

Interior seating	325i	325xi	330i	330xi
8-way adjustable front seats (includes 2-way headrests)	●	●		
8-way power front seats with 2-way manual headrests and driver memory with 2 pre-sets for exterior mirror and seat positions	○/◇	○/◇	●	●
8-way manual adjustable front sport seats with adjustable back bolsters, and 2-way headrests and thigh support	□	□		
8-way power front sport seats with adjustable back bolsters, 2-way manual headrests and thigh support; driver memory for exterior mirror and seat positions	□ ⁵	□ ⁵	□	□
4-way adjustable power lumbar support for front seats	◇	◇	◇	◇
Leatherette upholstery	●	●	●	●
Leather upholstery	○/◇	○/◇	○/◇	○/◇
3-stage heated front seats	○/★	○/★	○/★	○/★
3-spoke leather-wrapped multi-function steering wheel with audio and accessory phone ⁶ controls	●	●	●	●
3-spoke leather-wrapped multi-function sport steering wheel with audio and accessory phone ⁶ controls	□	□	□	□
Front seatback storage nets	●	●	●	●
Split fold-down through-load rear seats and ski bag	○/★	○/★	○/★	○/★
Burl Walnut Wood trim	●	●	●	●
Poplar Natural Wood trim	○	○	○	○
Aluminum interior trim ⁷	○	○	○	○

Audio system	325i	325xi	330i	330xi
Anti-theft AM/FM stereo CD/MP3 player audio system with 10 speakers (including 2 subwoofers), Radio Data System (RDS), Auto-Store and 3-channel FM diversity antenna; displays MP3 song title and artist	●	●		
Logic7 Surround Sound anti-theft AM/FM stereo CD/MP3 player audio system with 13 upgraded speakers (including 2 subwoofers), Digital Sound Processing (DSP), Radio Data System (RDS), Auto-Store and 3-channel FM diversity antenna; displays MP3 song title and artist	○	○	●	●
Auxiliary audio input for portable music players	●	●	●	●
Pre-wiring for BMW center installation of 6-disc CD/MP3 changer	●	●	●	●
SIRIUS Satellite Radio ⁸	○	○	○	○
Pre-wiring for BMW center installation of SIRIUS Satellite Radio ⁸	○	○	○	○

Instrumentation and controls	325i	325xi	330i	330xi
Service Interval Indicator with miles-to-service readout	●	●	●	●
Check Control vehicle monitor system with pictogram display, oil status display, and Condition Based Service indicator	●	●	●	●
On-board computer with Check Control – provides feedback on the vehicle's operating status: oil level indicator and distance to next service appointment/oil change, as well as other detailed information, such as spark plug and micro-filter status. It also provides travel information – travel range on remaining fuel, external temperature, and more	●	●	●	●
On-board navigation system with 16:9 screen and Voice Command system; iDrive system with high-function on-board computer and controller	○	○	○	○

- Standard
- Optional
- Included in optional Sport Package
- ◇ Included in optional Premium Package
- ★ Included in optional Cold Weather Package

⁵ Optional power seats or Premium Package required.

⁶ If so equipped.

⁷ No-cost option.

⁸ Pre-wiring required for SIRIUS Satellite Radio.

Please visit your authorized BMW center for details on equipment.

Equipment

Comfort and convenience	325i	325xi	330i	330xi
Engine Start/Stop button	●	●	●	●
Advanced Vehicle & Key Memory – includes climate-control temperature and air-distribution settings, exterior mirror and power seat settings ⁹ audio tone settings and radio presets with optional on-board navigation system, central-locking preferences, and lighting preferences	●	●	●	●
Comfort Access keyless entry with multi-function remote control	○	○	○	○
Automatic climate control – includes micro-filter, automatic air recirculation, left/right temperature control, temperature- and volume-controlled rear outlets, windshield misting sensor, maximum air conditioning, heat at rest, more powerful fan, and recall of individual user settings	●	●	●	●
2-way power glass moonroof with “one-touch” operation, sliding interior sunshade, and wind deflector	●	●	●	●
Front-seat center armrest with climate-controlled storage compartment	●	●	●	●
Front passenger cupholders (dashboard-integrated)	●	●	●	●
Rear-seat center armrest with cupholders	●	●	●	●
Tilt/telescopic steering wheel column	●	●	●	●
Park Distance Control (PDC) (rear only)	○	○	○	○
Interior and power-adjustable folding exterior mirrors with automatic-dimming function; digital compass	◇	◇	◇	◇
Power front and rear windows with “one-touch” up/down operation	●	●	●	●
Power rear sunshade; manual rear side window shades	○	○	○	○
Dynamic Cruise Control	●	●	●	●
Active Cruise Control	○	○	○	○
BMW Ambiance Lighting front and rear	●	●	●	●
Courtesy lights – include fade in/fade out, actuation from remote, automatic switch-on when engine is turned off, separately controlled left/right front and rear reading lights, front footwell lighting, and illuminated vanity mirrors	●	●	●	●
Ground-illuminating lights in door handles	●	●	●	●
Locking glovebox	●	●	●	●
Electric interior trunk release	●	●	●	●
Rain-sensing windshield wipers and Automatic headlight control	●	●	●	●
Integrated 3-button Universal garage-door opener	◇	◇	◇	◇
Bluetooth® wireless technology ¹⁰ for hands-free calling with Bluetooth technology enabled mobile phones ¹¹	○	○	○	○
Pre-wiring for BMW center installation of mobile phone, alarm system	●	●	●	●

- Standard
- Optional
- Included in optional Sport Package
- ◇ Included in optional Premium Package
- ★ Included in optional Cold Weather Package

⁹Optional and included in 325i/325xi Premium Package; standard in 330i/330xi.

¹⁰Included with Premium Package or BMW Assist.

¹¹Please contact your authorized BMW center for a list of BMW-approved Bluetooth technology enabled mobile phones.

Equipment

Safety and security	325i	325xi	330i	330xi
Anti-lock braking system (ABS)	●	●	●	●
Adaptive Brake Lights	●	●	●	●
MRS5 centralized safety control system	●	●	●	●
Front and rear Head Protection System (HPS)	●	●	●	●
Driver's and passenger's front airbag supplemental restraint system (SRS) with "smart" dual-threshold, dual-stage deployment and sensor to help prevent unnecessary passenger's airbag deployment	●	●	●	●
Seat-mounted front side-impact airbags	●	●	●	●
Automatic safety belt pretensioners at front and rear outboard seating positions	●	●	●	●
Front passenger seat-occupation recognition with Passenger's Airbag Off indicator	●	●	●	●
Interlocking door anchoring system to help protect against door intrusion in side impacts	●	●	●	●
Central locking system with center console switch (leaves gas filler door unlocked), double-lock feature and 2-step unlocking	●	●	●	●
Coded Driveaway Protection	●	●	●	●
Automatic-locking retractors (ALR) on all passenger safety belts for installation of child-restraint seat	●	●	●	●
LATCH attachments on child-restraint safety installation	●	●	●	●
Crash sensor that automatically turns on hazard lights and interior lights, and unlocks doors	●	●	●	●
Programmable daytime running lights	●	●	●	●
Fiber-optics-based MOST-BUS architecture for safety systems	●	●	●	●
BMW Assist™ ¹² with Bluetooth® wireless technology	○◇	○◇	○◇	○◇

BMW Maintenance Program	325i	325xi	330i	330xi
BMW Maintenance ¹³	●	●	●	●

- Standard
- Optional
- Included in optional Sport Package
- ◇ Included in optional Premium Package
- ★ Included in optional Cold Weather Package

¹² Please see your authorized BMW center for rules and regulations on subscription required with BMW Assist.

¹³ BMW Maintenance Program covers all factory-recommended maintenance on all new MY 2004 and later BMW vehicles, as determined by the Service Interval Indicator, for 4 years or 50,000 miles, whichever comes first. Exclusions from coverage: gasoline, gasoline additives, windshield washer fluids and additives, lights, tires, wheels, wheel alignment, tire balancing and rotation. All work must be performed by an authorized BMW center. See the Service and Warranty Information booklet for more specific terms, conditions and limitations. Further information can be obtained from your local authorized BMW center.

Equipment

Premium Packages	325i	325xi	330i	330xi
8-way power front seats with 2-way manual headrests and driver memory for exterior mirror and seat positions	○/◇	○/◇	●	●
4-way adjustable power lumbar support for front seats	◇	◇	◇	◇
Leather upholstery	○/◇	○/◇	○/◇	○/◇
Interior and power-adjustable folding exterior mirrors with automatic-dimming function; digital compass	◇	◇	◇	◇
Integrated 3-button Universal garage-door opener	◇	◇	◇	◇
BMW Assist™ ¹⁴ with Bluetooth® wireless technology	○/◇	○/◇	○/◇	○/◇

Sport Packages	325i	325xi	330i	330xi
Double Spoke (Style 161) light-alloy wheels, 17 x 8.0 front, 17 x 8.5 rear; 225/45R-17 front, 255/40R-17 rear run-flat ¹⁵ performance tires ¹⁶	□	○ ¹⁷		
17 x 8.0 Star Spoke (Style 159) light-alloy wheels, 225/45R-17 run-flat ¹⁵ all-season tires		□		
Star Spoke (Style 162) light-alloy wheels, 18 x 8.0 front, 18 x 8.5 rear; 225/40R-18 front, 255/35R-18 rear run-flat ¹⁵ performance tires ¹⁶			□	○ ¹⁷
17 x 8.0 Star Spoke (Style 158) light-alloy wheels, 225/45R-17 run-flat ¹⁵ all-season tires				□
8-way manual adjustable front sport seats with adjustable back bolsters, and 2-way headrests and thigh support	□	□		
8-way power front sport seats with adjustable back bolsters, 2-way manual headrests and thigh support; driver memory for exterior mirror and seat positions	□ ¹⁸	□ ¹⁸	□	□
3-spoke leather-wrapped multi-function sport steering wheel with audio controls	□	□	□	□
Sport suspension calibration	□		□	

Cold Weather Package	325i	325xi	330i	330xi
3-stage heated front seats	○/★	○/★	○/★	○/★
Split fold-down through-load rear seats and ski bag	○/★	○/★	○/★	○/★
Retractable, high-intensity headlight washers	★	●	★	●

- Standard
- Optional
- Included in optional Sport Package
- ◇ Included in optional Premium Package
- ★ Included in optional Cold Weather Package

¹⁴ Please see your authorized BMW center for rules and regulations on subscription required with BMW Assist.

¹⁵ Run-flat tires do not come equipped with spare tire.

¹⁶ Due to low-profile tires, please note: wheels, tires and suspension parts are more susceptible to road hazard and consequential damages. Performance tires are not recommended for driving in snow and ice.

¹⁷ Sport Package required.

¹⁸ Optional power seats or Premium Package required; Sport Package also required.

Equipment

Weight		325i	325xi	330i	330xi
Unladen	lbs	3285 (3351)	3560 (3605)	3417 (3450)	3627 (3671)
Weight distribution, front/rear					
Manual transmission	%	50.3/49.7	52.6/47.4	50.6/49.4	52.6/47.4
Automatic transmission	%	50.7/49.3	52.9/47.1	51.1/48.9	52.9/47.1

Engine		325i	325xi	330i	330xi
Liter/type		3.0/inline 6	3.0/inline 6	3.0/inline 6	3.0/inline 6
Bore/stroke	inch	3.35/3.46	3.35/3.46	3.35/3.46	3.35/3.46
Nominal output/rpm	hp	215/6250	215/6250	255/6600	255/6600
Maximum torque/rpm	lb-ft	185/2750	185/2750	220/2750	220/2750
Compression ratio	:1	10.7	10.7	10.7	10.7
Fuel grade		Unleaded premium	Unleaded premium	Unleaded premium	Unleaded premium

Transmission		325i	325xi	330i	330xi
Manual gear ratios					
I/II	:1	4.32/2.46	4.32/2.46	4.35/2.50	4.35/2.50
III/IV	:1	1.66/1.23	1.66/1.23	1.67/1.23	1.67/1.23
V/VI/R	:1	1.00/0.85/3.94	1.00/0.85/3.94	1.00/0.85/3.93	1.00/0.85/3.93
Final drive ratio	:1	3.23	3.23	3.15	3.15
Automatic gear ratio					
I/II	:1	4.17/2.34	4.17/2.34	4.17/2.34	4.17/2.34
III/IV	:1	1.52/1.14	1.52/1.14	1.52/1.14	1.52/1.14
V/VI/R	:1	0.87/0.69/3.40	0.87/0.69/3.40	0.87/0.69/3.40	0.87/0.69/3.40
Final drive ratio	:1	3.73	3.73	3.64	3.64

Equipment

Performance		325i	325xi	330i	330xi
Drag coefficient	C_d	0.30	0.31	0.30	0.32
Top speed ¹	mph	130 [149]	130 [146]	130 [149]	130 [150]
Acceleration 0-60 mph ²					
Manual transmission	sec	6.7	7.1	6.1	6.3
Automatic transmission	sec	7.2	7.7	6.3	6.6

Fuel consumption³		325i	325xi	330i	330xi
Manual transmission – City/Highway	mpg	20/30	19/28	20/30	19/28
Automatic transmission – City/Highway	mpg	21/29	20/27	21/29	20/27

Tires and wheels		325i	325xi	330i	330xi
Tire dimensions	standard	205/55R-16	205/55R-16	225/45R-17	225/45R-17
Wheel dimensions	standard	16 x 7.0	16 x 7.0	17 x 8.0	17 x 8.0
Material	standard	light-alloy	light-alloy	light-alloy	light-alloy

Brakes		325i	325xi	330i	330xi
Front – diameter	inch	11.8	11.8	13.0	13.0
Rear – diameter	inch	11.8	11.8	13.2	13.2

Figures in [] apply to vehicles with Sport Package.

¹ Top speed limited electronically.

² BMW AG test results. Actual acceleration results may vary, depending on specification of vehicle; road and environmental conditions; testing procedures and driving style. These results should be used for comparison only and verification should not be attempted on public roads. BMW urges you to obey all posted speed laws and always wear safety belts.

³ EPA-estimated figures are for comparison purposes only. Your actual mileage will vary, depending on speed, driving habits, trip length and driving conditions; actual mileage may be lower.

U.S. Importer: BMW of North America, LLC, Woodcliff Lake, NJ 07677. All illustrations and specifications contained in this brochure are based on the latest product information available at the time of printing. BMW reserves the right to make changes at any time, without notice, in colors, materials, equipment, specifications and models. BMW may, subject to legal requirements, determine the Model Year designation of its vehicles. The Model Year designation on any particular model may be longer or shorter than 12 months. Some vehicles pictured may contain non-U.S. equipment. Some models may be shown with optional equipment. While BMW NA makes diligent efforts to provide accurate information in this brochure, there is no guarantee or warranty of accuracy. Furthermore, we do not assume any liability for the accuracy or

completeness of information presented. This brochure shall not be used or relied upon as a substitute for information that is available from your BMW center. Further information can be obtained from your authorized BMW center or bmwusa.com.

©2006 BMW of North America, LLC. Not to be reproduced wholly or in part without written permission of BMW NA.

The BMW name and logo are registered trademarks.

The Bluetooth word mark and logos are owned by the Bluetooth SIG, Inc. and any use of such marks by BMW is under license. Other trademarks and trade names are those of their respective owners.

BMW recommends 

Technical data

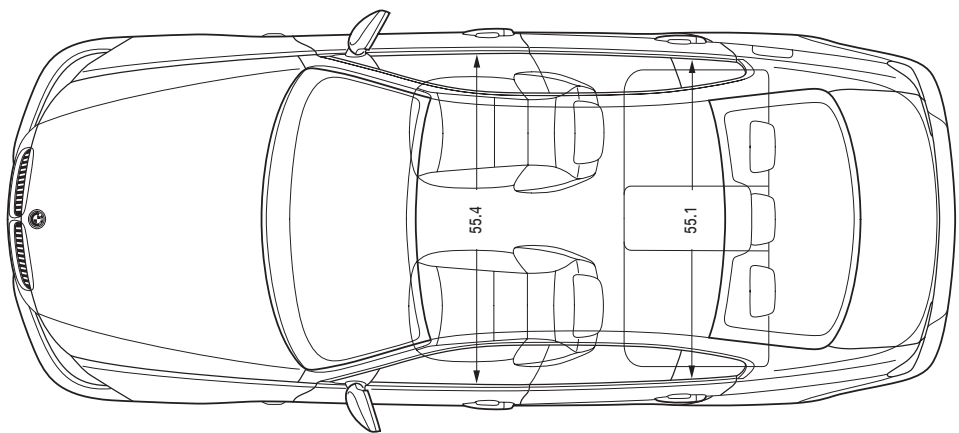
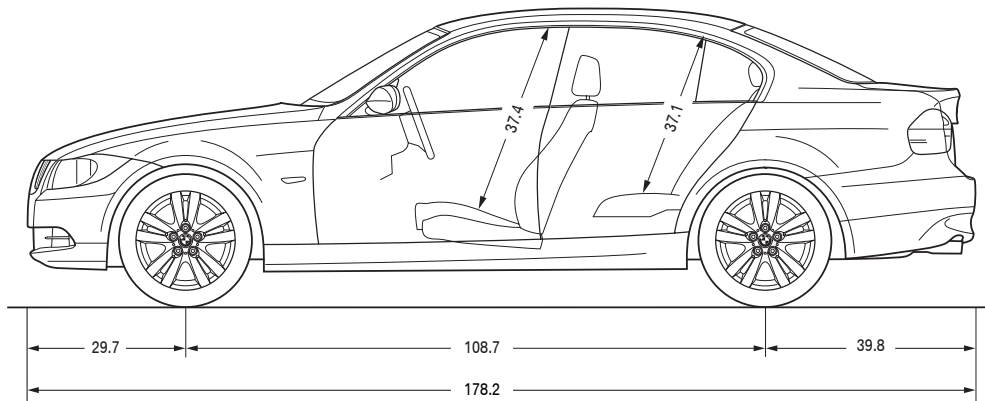
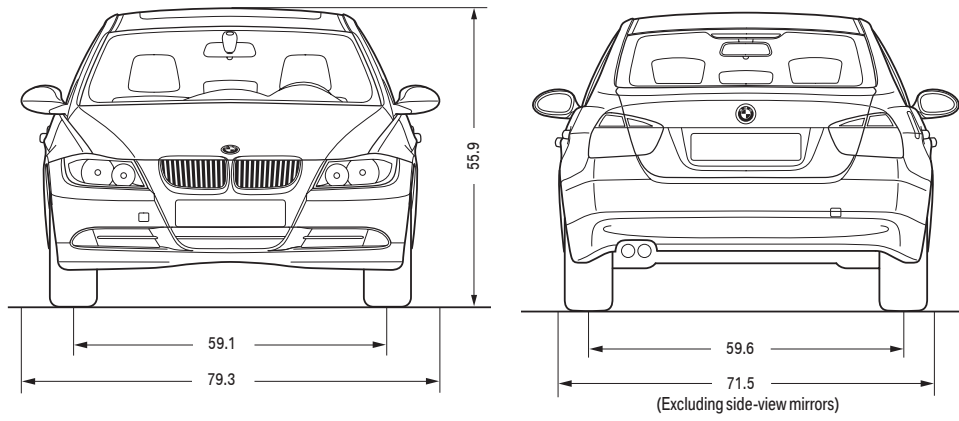

Illustrations above: all dimensions in inches.