

2014

OWNER'S MANUAL

Dart

## VEHICLES SOLD IN CANADA

With respect to any Vehicles Sold in Canada, the name Chrysler Group LLC shall be deemed to be deleted and the name Chrysler Canada Inc. used in substitution therefore.

## DRIVING AND ALCOHOL

Drunken driving is one of the most frequent causes of accidents.

Your driving ability can be seriously impaired with blood alcohol levels far below the legal minimum. If you are drinking, don't drive. Ride with a designated non-drinking driver, call a cab, a friend, or use public transportation.

### WARNING!

Driving after drinking can lead to an accident. Your perceptions are less sharp, your reflexes are slower, and your judgment is impaired when you have been drinking. Never drink and then drive.

This manual illustrates and describes the operation of features and equipment that are either standard or optional on this vehicle. This manual may also include a description of features and equipment that are no longer available or were not ordered on this vehicle. Please disregard any features and equipment described in this manual that are not on this vehicle.

Chrysler Group LLC reserves the right to make changes in design and specifications, and/or make additions to or improvements to its products without imposing any obligation upon itself to install them on products previously manufactured.

Copyright © 2013 Chrysler Group LLC



# TABLE OF CONTENTS

SECTION		PAGE
1	INTRODUCTION .....	3
2	THINGS TO KNOW BEFORE STARTING YOUR VEHICLE .....	9
3	UNDERSTANDING THE FEATURES OF YOUR VEHICLE .....	113
4	UNDERSTANDING YOUR INSTRUMENT PANEL .....	301
5	STARTING AND OPERATING .....	403
6	WHAT TO DO IN EMERGENCIES .....	517
7	MAINTAINING YOUR VEHICLE .....	555
8	MAINTENANCE SCHEDULES .....	611
9	IF YOU NEED CONSUMER ASSISTANCE .....	619
10	INDEX .....	629



# INTRODUCTION

## CONTENTS

---

■ INTRODUCTION . . . . .	4	■ VEHICLE IDENTIFICATION NUMBER . . . . .	6
■ HOW TO USE THIS MANUAL . . . . .	4	■ VEHICLE MODIFICATIONS/ALTERATIONS . . . . .	7
■ WARNINGS AND CAUTIONS . . . . .	6		

### INTRODUCTION

Congratulations on selecting your new Chrysler Group LLC vehicle. Be assured that it represents precision workmanship, distinctive styling, and high quality - all essentials that are traditional to our vehicles.

This Owner's Manual has been prepared with the assistance of service and engineering specialists to acquaint you with the operation and maintenance of your vehicle. It is supplemented by Warranty Information, and various customer-oriented documents. Please take the time to read these publications carefully. Following the instructions and recommendations in this manual will help assure safe and enjoyable operation of your vehicle.

**NOTE: After reviewing the owner information, it should be stored in the vehicle for convenient referencing and remain with the vehicle when sold.**

When it comes to service, remember that your authorized dealer knows your vehicle best, has factory-trained technicians and genuine parts, and cares about your satisfaction.









































































### HOW TO USE THIS MANUAL

Consult the Table of Contents to determine which section contains the information you desire.

Since the specification of your vehicle depends on the items of equipment ordered, certain descriptions and illustrations may differ from your vehicle's equipment.

The detailed index at the back of this Owner's Manual contains a complete listing of all subjects.

Consult the following table for a description of the symbols that may be used on your vehicle or throughout this Owner's Manual:

 WATER IN FUEL	 REAR WINDOW WIPER	 WINDSHIELD WIPER INTERMITTENT	 EXTERIOR BULB FAILURE	 HIGH BEAM	 TURN SIGNALS	 UPPER AIR OUTLET	 HEATED SEAT LOW	 DOOR LOCK	 ADJUSTABLE PEDALS	 ELECTRONIC SPEED CONTROL	 ESP BAS ELECTRONIC STABILITY PROGRAM / BRAKE ASSIST SYSTEM
 FUEL	 REAR WINDOW WIPER WASHER	 WINDSHIELD WASHER	 MASTER LIGHTING SWITCH	 LOW BEAM	 KEY ACTIVATE (POWER OUTLET)	 UPPER AND LOWER AIR OUTLET	 HEATED SEAT HIGH	 WINDOW LIFT	 TIRE PRESSURE MONITOR	 HILL DESCENT CONTROL	 BRAKE SYSTEM WARNING PARKING BRAKE
 FUEL FILL SIDE	 REAR WINDOW WASHER	 WINDSHIELD WASHER FLUID LEVEL	 DOME LIGHT	 FRONT FOG LIGHT	 HOOD RELEASE	 LOWER AIR OUTLET	 RECIRCULATION	 CONVERTIBLE 4 WINDOW DOWN	 ELECTRONIC STABILITY CONTROL	 AWD!	 FAILURE OF ANTI-LOCK BRAKING SYSTEM
 ENGINE OIL	 REAR WINDOW DEFROST	 WINDSHIELD, ELECTRICALLY HEATED	 PARK LIGHTS	 REAR FOG LAMP	 LIFTGATE RELEASE AND LIFTGATE OPEN	 DEFROST AND LOWER AIR OUTLET	 VENTILATING FAN	 WINDOW LOCK	 ELECTRONIC THROTTLE CONTROL	 4WD!	 BRAKE SYSTEM WARNING PARKING BRAKE
 BATTERY CHARGING	 HEATED MIRROR	 WINDSHIELD DEFROST	 INSTRUMENT PANEL ILLUMINATION	 SEAT BELT	 SLIDING DOOR	 TRUNK / DECK RELEASE	 AIR CONDITIONING	 CHILD SEAT TETHER ANCHOR	 VOICE RECOGNITION BUTTON	 WARNING	 TOW/HAUL
 GLOW PLUG	 POWER STEERING FLUID	 WINDSHIELD WIPER AND WASHER	 SIDE AIRBAG	 AIRBAG	 SLIDING DOOR	 EMERGENCY RELEASE HANDLE	 LIGHTER	 LOWER ANCHORS AND TETHER FOR CHILDREN (LATCH)	 UCONNECT™ BUTTON	 HAZARD	 4 LOW
 MALFUNCTION INDICATOR LIGHT	 TRANS OIL TEMP	 ENGINE COOLANT TEMPERATURE	 SRS AIRBAG SUPPLEMENTAL RESTRAINT SYSTEM	 PASSENGER AIRBAG OFF	 DOOR AJAR	 CONVERTIBLE TOP DOWN	 CONVERTIBLE TOP UP	 HORN	 SEE OWNER'S MANUAL ISO	 A/C PUSH AIR CONDITIONER	 ELECTRONIC STABILITY CONTROL OFF

## WARNINGS AND CAUTIONS

This Owners Manual contains **WARNINGS** against operating procedures that could result in a collision or bodily injury. It also contains **CAUTIONS** against procedures that could result in damage to your vehicle. If you do not read this entire Owners Manual, you may miss important information. Observe all Warnings and Cautions.

## VEHICLE IDENTIFICATION NUMBER

The Vehicle Identification Number (VIN) is found on the left front corner of the instrument panel, visible through the windshield. This number also is stamped into the right front body, on the right front seat crossmember under the carpet and the vehicle registration and title.

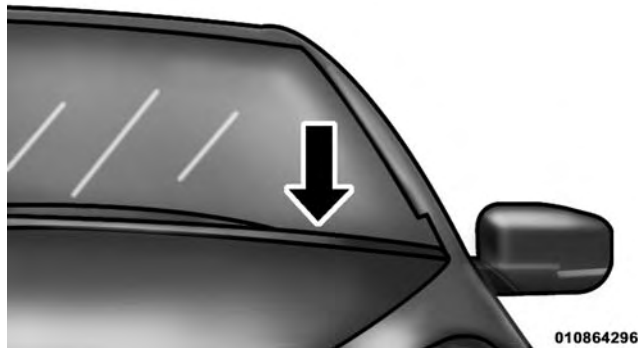

VIN Location



## VEHICLE MODIFICATIONS/ALTERATIONS

**WARNING!**

Any modifications or alterations to this vehicle could seriously affect its roadworthiness and safety and may lead to a collision resulting in serious injury or death.

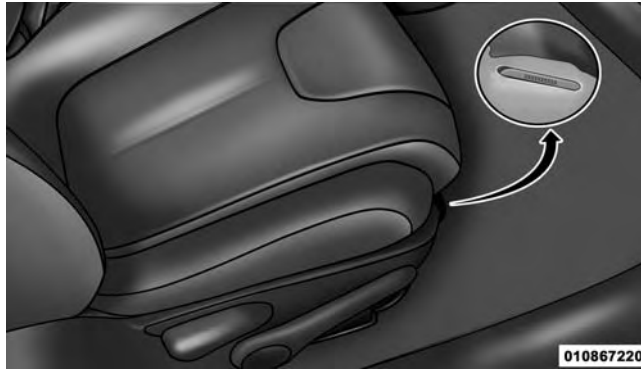
**Right Front Body VIN Location**

**NOTE:** It is illegal to remove or alter the VIN.



# THINGS TO KNOW BEFORE STARTING YOUR VEHICLE

## CONTENTS

2

- A WORD ABOUT YOUR KEYS . . . . .12
  - Ignition Node Module (IGNM) — If Equipped . . .12
  - Keyless Ignition Node (KIN) — If Equipped . . .13
  - Standard Blade Ignition Key — If Equipped . . .15
  - Key Fob — If Equipped . . . . .16
  - Ignition Or Accessory On Message . . . . .17
- SENTRY KEY® . . . . .19
  - Replacement Keys . . . . .20
  - Customer Key Programming . . . . .20
  - General Information . . . . .20
- VEHICLE SECURITY ALARM — IF EQUIPPED . . .21
  - Rearming Of The System . . . . .21
  - To Arm The System . . . . .21
  - To Disarm The System . . . . .22
  - Tamper Alert . . . . .23
  - Security System Manual Override . . . . .23
- ILLUMINATED ENTRY . . . . .23
- REMOTE KEYLESS ENTRY (RKE) . . . . .24
  - To Unlock The Doors . . . . .25
  - To Lock The Doors . . . . .26

## 10 THINGS TO KNOW BEFORE STARTING YOUR VEHICLE

- To Unlatch The Trunk . . . . .26
- Using The Panic Alarm . . . . .26
- Programming Additional Transmitters. . . . .27
- Transmitter Battery Replacement . . . . .27
- General Information . . . . .28
- REMOTE STARTING SYSTEM — IF EQUIPPED . .28
  - How To Use Remote Start . . . . .29
- DOOR LOCKS . . . . .32
  - Manual Door Locks. . . . .32
  - Power Door Locks . . . . .33
  - Child-Protection Door Lock System — Rear Doors . . . . .35
- KEYLESS ENTER-N-GO™ . . . . .36
- WINDOWS . . . . .41
  - Power Windows . . . . .41
  - Wind Buffeting . . . . .45
- TRUNK LOCK AND RELEASE . . . . .45
- TRUNK SAFETY WARNING. . . . .46
  - Trunk Emergency Release . . . . .46
- OCCUPANT RESTRAINTS . . . . .47
  - Lap/Shoulder Belts . . . . .51
  - Lap/Shoulder Belt Untwisting Procedure . . . . .56
  - Seat Belts In Passenger Seating Positions . . . . .57
  - Automatic Locking Retractor Mode (ALR) — If Equipped . . . . .58
  - Energy Management Feature . . . . .59

- Belt Pretensioning And Load Limitation . . . . .59
- Enhanced Seat Belt Use Reminder System (BeltAlert®) . . . . .59
- Seat Belts And Pregnant Women . . . . .60
- Seat Belt Extender . . . . .61
- Supplemental Restraint System (SRS) — Air Bags . . . . .61
- Air Bag Deployment Sensors And Controls . . . .67
- Event Data Recorder (EDR) . . . . .83
- Child Restraints . . . . .84

- ENGINE BREAK-IN RECOMMENDATIONS . . .106
- SAFETY TIPS . . . . .107
  - Transporting Passengers . . . . .107
  - Exhaust Gas . . . . .108
  - Safety Checks You Should Make Inside The Vehicle . . . . .109
  - Periodic Safety Checks You Should Make Outside The Vehicle . . . . .111

## A WORD ABOUT YOUR KEYS

Your vehicle uses either a key start ignition system or keyless ignition system. The key start ignition system consists of either a bladed key with an immobilizer chip in it, or a Key Fob with Remote Keyless Entry (RKE) transmitter and an Ignition Node Module (IGNM). The keyless ignition system consists of a Key Fob with Remote Keyless Entry (RKE) transmitter and a Keyless Ignition Node (KIN).

### Ignition Node Module (IGNM) — If Equipped

The Ignition Node Module (IGNM) operates similar to an ignition switch. It has four operating positions, three with detents and one that is spring-loaded. The detent positions are OFF, ACC, and ON/RUN. The START position is a spring-loaded momentary contact position. When released from the START position, the switch automatically returns to the ON/RUN position.

**NOTE:** If your vehicle is equipped with Keyless Enter-N-Go™, the Electronic Vehicle Information Center (EVIC) will display the ignition switch position (OFF/ACC/RUN). Refer to “Electronic Vehicle Information Center (EVIC) — If Equipped” in “Understanding Your Instrument Panel” for further information.

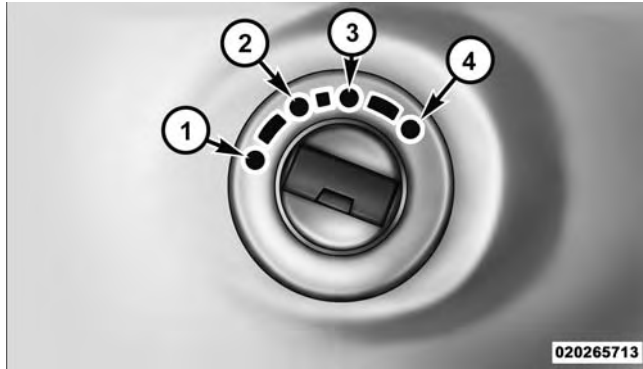

Wireless Ignition Node (WIN)

- 1 — OFF
- 2 — ACC (ACCESSORY)
- 3 — ON/RUN
- 4 — START

### Keyless Ignition Node (KIN) — If Equipped

This feature allows the driver to operate the ignition switch with the push of a button, as long as the Remote Keyless Entry (RKE) transmitter is in the passenger compartment.

The Keyless Ignition Node (KIN) has four operating positions, three of which are labeled and will illuminate when in position. The three positions are OFF, ACC, and ON/RUN. The fourth position is START, during start RUN will illuminate.

## 14 THINGS TO KNOW BEFORE STARTING YOUR VEHICLE

**NOTE:** In case the ignition switch does not change with the push of a button, the RKE transmitter (Key Fob) may have a low or dead battery. In this situation a back up method can be used to operate the ignition switch. Put the nose side (side opposite of the emergency key) of the Key Fob against the ENGINE START/STOP button and push to operate the ignition switch.

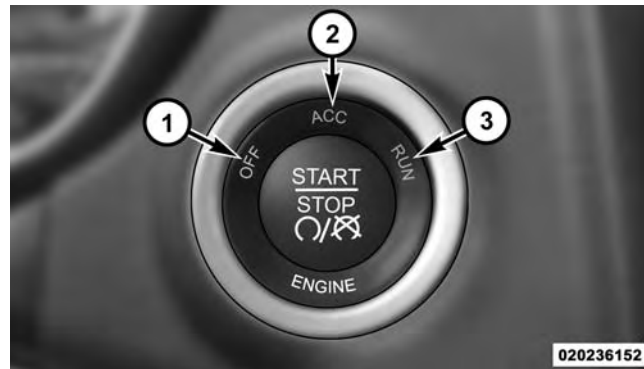

Keyless Ignition Node (KIN)

- 1 — OFF
  - 2 — ACC (ACCESSORY)
  - 3 — ON/RUN
-



### Keyless Enter-N-Go™ Feature

If your vehicle is equipped with the Keyless Enter-N-Go™ feature, refer to “Starting Procedure” in “Starting And Operating” for further information.

### Standard Blade Ignition Key — If Equipped

Your vehicle may use a standard blade key ignition system. The authorized dealer that sold you your vehicle has the key code numbers for your vehicle locks. These numbers can be used to order duplicate keys from your authorized dealer. Ask your authorized dealer for these numbers and keep them in a safe place. You can insert the double-sided standard blade key into the ignition switch or lock cylinders with either side up.



2

020265786

Standard Blade Ignition Key

## Key Fob — If Equipped

The Key Fob also contains the Remote Keyless Entry (RKE) transmitter and an emergency key, which stores in the rear of the Key Fob.

The emergency key allows for entry into the vehicle should the battery in the vehicle or the Key Fob go dead. You can keep the emergency key with you when valet parking.

To remove the emergency key, slide the mechanical latch on the face of the Key Fob sideways with your thumb and then pull the key out with your other hand.

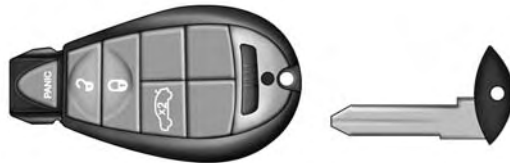

020207467

Emergency Key Removal (IGNM)



0202005283

### Emergency Key Removal (KIN)

**NOTE:** You can insert the double-sided emergency key into the lock cylinders with either side up.

### Ignition Or Accessory On Message

Opening the driver's door when the ignition is in ACC or ON (engine not running), a chime will sound to remind you to place the ignition in the OFF position. In addition to the chime, the ignition or accessory on message will display in the cluster.

**NOTE:** With the Uconnect® system, the power window switches, radio, power sunroof (if equipped), and power outlets will remain active for up to 10 minutes after the ignition is cycled to the OFF position. Opening either front door will cancel this feature. The time for this feature is programmable. Refer to "Uconnect® Settings" in "Understanding Your Instrument Panel" for further information.

**WARNING!**

- When leaving the vehicle, always remove the Key Fob from the vehicle and lock your vehicle.
- Never leave children alone in a vehicle, or with access to an unlocked vehicle.
- Allowing children to be in a vehicle unattended is dangerous for a number of reasons. A child or others could be seriously or fatally injured. Children should be warned not to touch the parking brake, brake pedal or the shift lever.
- Do not leave the Key Fob in or near the vehicle, or in a location accessible to children, and do not leave the ignition of a vehicle equipped with Keyless Enter-N-Go™ in the ACC or ON/RUN mode. A child could operate power windows, other controls, or move the vehicle.

**WARNING! (Continued)**

- Do not leave children or animals inside parked vehicles in hot weather. Interior heat build-up may cause serious injury or death.

**CAUTION!**

An unlocked car is an invitation to thieves. Always remove key from the ignition and lock all doors when leaving the vehicle unattended.

*(Continued)*

## SENTRY KEY®

The Sentry Key® Immobilizer system prevents unauthorized vehicle operation by disabling the engine. The system does not need to be armed or activated. Operation is automatic, regardless of whether the vehicle is locked or unlocked.

The system uses a Key or Key Fob with Remote Keyless Entry (RKE) transmitter, an RF receiver, and either an Ignition Node Module (IGNM) or a Keyless Ignition Node (KIN) to prevent unauthorized vehicle operation. Therefore, only Keys or Key Fobs that are programmed to the vehicle can be used to start and operate the vehicle.

After placing the ignition in the ON/RUN position, the Vehicle Security Light will turn on for three seconds for a bulb check. If the light remains on after the bulb check, it indicates that there is a problem with the electronics. In addition, if the light begins to flash after the bulb check,

it indicates that someone used an invalid Key Fob to start the engine. Either of these conditions will result in the engine being shut off after two seconds.

If the Vehicle Security Light turns on during normal vehicle operation (vehicle running for longer than 10 seconds), it indicates that there is a fault in the electronics. Should this occur, have the vehicle serviced as soon as possible by an authorized dealer.

### CAUTION!

**The Sentry Key® Immobilizer system is not compatible with some aftermarket remote starting systems. Use of these systems may result in vehicle starting problems and loss of security protection.**

All of the Key Fobs provided with your new vehicle have been programmed to the vehicle electronics.

## Replacement Keys

**NOTE:** Only Keys or Key Fobs that are programmed to the vehicle electronics can be used to start and operate the vehicle. Once a Key or Key Fob is programmed to a vehicle, it cannot be programmed to any other vehicle.

### CAUTION!

**Always remove the keys from the vehicle and lock all doors when leaving the vehicle unattended.**

At the time of purchase, the original owner is provided with a four-digit Personal Identification Number (PIN). Keep the PIN in a secure location. This number is required for authorized dealer replacement of Key Fobs. Duplication of Key Fobs may be performed at an authorized dealer, this procedure consists of programming a blank Key Fob to the vehicle electronics. A blank Key Fob is one that has never been programmed.

**NOTE:** When having the Sentry Key® Immobilizer system serviced, bring all vehicle Key Fobs with you to an authorized dealer.

## Customer Key Programming

Programming Keys or Key Fobs with RKE transmitters may be performed at an authorized dealer.

## General Information

The Sentry Key® system complies with FCC rules part 15 and with RSS-210 of Industry Canada. Operation is subject to the following conditions:

- This device may not cause harmful interference.
- This device must accept any interference that may be received, including interference that may cause undesired operation.

**NOTE:** Changes or modifications not expressly approved by the party responsible for compliance could void the user's authority to operate the equipment.

## VEHICLE SECURITY ALARM — IF EQUIPPED

The Vehicle Security Alarm monitors the vehicle doors for unauthorized entry and the ignition switch for unauthorized operation. This system may also incorporate an ultrasonic intrusion sensor that monitors for motion in the vehicle. If something triggers the alarm, the Vehicle Security Alarm will provide the following audible and visible signals: the horn will pulse, the headlights, park lamps and/or turn signals will flash, and the Vehicle Security Light in the instrument cluster will flash.

### Rearming Of The System

If something triggers the alarm, and no action is taken to disarm it, the Vehicle Security Alarm will turn the horn off after three minutes, turn all of the visual signals off after 15 minutes, and then the Vehicle Security Alarm will rearm itself.

## To Arm The System

Follow these steps to arm the Vehicle Security Alarm:

1. Remove the key from the ignition system (refer to "Starting Procedures" in "Starting And Operating" for further information).
  - For vehicles equipped with Keyless Enter-N-Go™, make sure the vehicle ignition system is OFF.
  - For vehicles not equipped with Keyless Enter-N-Go™, make sure the vehicle ignition system is OFF and the key is physically removed from the ignition.
2. Perform one of the following methods to lock the vehicle:
  - Press LOCK on the interior power door lock switch with the driver and/or passenger door open.

## 22 THINGS TO KNOW BEFORE STARTING YOUR VEHICLE

- Press the LOCK button on the exterior Passive Entry Door Handle with a valid Key Fob available in the same exterior zone (refer to "Keyless Enter-N-Go™" in "Things To Know Before Starting Your Vehicle" for further information).
- Press the LOCK button on the Remote Keyless Entry (RKE) transmitter.
- Cycle the vehicle ignition system out of the OFF position.
  - For vehicles equipped with Keyless Enter-N-Go™, press the Keyless Enter-N-Go™ Start/Stop button (requires at least one valid Key Fob in the vehicle).
  - For vehicles not equipped with Keyless Enter-N-Go™, insert a valid key into the ignition switch and turn the key to the ON position.

3. If any doors are open, close them.

### To Disarm The System

The Vehicle Security Alarm can be disarmed using any of the following methods:

- Press the UNLOCK button on the Remote Keyless Entry (RKE) transmitter.
- Grasp the Passive Entry Unlock Door Handle (if equipped, refer to "Keyless Enter-N-Go™" in "Things To Know Before Starting Your Vehicle" for further information).
- The driver's door key cylinder and the liftgate button on the RKE transmitter cannot arm or disarm the Vehicle Security Alarm.
- The Vehicle Security Alarm remains armed during power liftgate entry. Pressing the liftgate button will not disarm the Vehicle Security Alarm. If someone enters the vehicle through the liftgate and opens any door the alarm will sound.
- When the Vehicle Security Alarm is armed, the interior power door lock switches will not unlock the doors.



The Vehicle Security Alarm is designed to protect your vehicle; however, you can create conditions where the system will give you a false alarm. If one of the previously described arming sequences has occurred, the Vehicle Security Alarm will arm regardless of whether you are in the vehicle or not. If you remain in the vehicle and open a door, the alarm will sound. If this occurs, disarm the Vehicle Security Alarm.

If the Vehicle Security Alarm is armed and the battery becomes disconnected, the Vehicle Security Alarm will remain armed when the battery is reconnected; the exterior lights will flash, the horn will sound. If this occurs, disarm the Vehicle Security Alarm.

### **Tamper Alert**

If something has triggered the Vehicle Security Alarm in your absence, the horn will sound three times and the exterior lights blink three times when you unlock the doors. Check the vehicle for tampering.

### **Security System Manual Override**

The Vehicle Security Alarm will not arm if you lock the doors using the manual door lock plunger.

### **ILLUMINATED ENTRY**

The courtesy lights will turn on when you use the Remote Keyless Entry (RKE) transmitter to unlock the doors or open any door.

This feature also turns on the approach lighting in the outside mirrors (if equipped). Refer to “Mirrors” in “Understanding The Features Of Your Vehicle” for further information.

The lights will fade to off after approximately 30 seconds or they will immediately fade to off once the ignition is cycled to the ON/RUN position from the OFF position.

## 24 THINGS TO KNOW BEFORE STARTING YOUR VEHICLE

### NOTE:

- The front courtesy overhead console and door courtesy lights will turn on if the dimmer control is in the "Dome ON" position (extreme top position).
- The Illuminated Entry system will not operate if the dimmer control is in the "Dome defeat" position (extreme bottom position).

### REMOTE KEYLESS ENTRY (RKE)

The RKE system allows you to lock or unlock the doors, open the trunk, or activate the Panic Alarm from distances up to approximately 66 ft (20 m) using a hand-held Key Fob with RKE transmitter. The RKE transmitter does not need to be pointed at the vehicle to activate the system.

**NOTE:** Driving at speeds 5 mph (8 km/h) and above disables the system from responding to all RKE transmitter buttons for all RKE transmitters.



021307469

Key Fob With RKE Transmitter (IGNM)



0202005282

### Key Fob With RKE Transmitter (KIN)

#### To Unlock The Doors

Press and release the UNLOCK button on the RKE transmitter once to unlock the driver's door or twice within five seconds to unlock all doors. The turn signal lights will flash to acknowledge the unlock signal. The illuminated entry system will also turn on.

If the vehicle is equipped with Passive Entry, refer to Keyless Enter-N-Go™ under “Things To Know Before Starting Your Vehicle” for further information.

#### 1st Press Of Key Fob Unlocks

This feature lets you program the system to unlock either the driver's door or all doors on the first press of the UNLOCK button on the RKE transmitter. To change the current setting, refer to “Uconnect® Settings” in “Understanding Your Instrument Panel” for further information.

#### Flash Headlights With Lock

This feature will cause the turn signal lights to flash when the doors are locked or unlocked with the RKE transmitter. This feature can be turned on or turned off. To change the current setting, refer to “Uconnect® Settings” in “Understanding Your Instrument Panel” for further information.

### **Headlight Illumination On Approach**

This feature activates the headlights for up to 90 seconds when the doors are unlocked with the RKE transmitter. The time for this feature is programmable on vehicles equipped through Uconnect®. To change the current setting, refer to “Uconnect® Settings” in “Understanding Your Instrument Panel” for further information.

### **To Lock The Doors**

Press and release the LOCK button on the RKE transmitter to lock all doors. The turn signal lights will flash and the horn will chirp to acknowledge the signal.

If the vehicle is equipped with Passive Entry, refer to “Keyless Enter-N-Go™” under “Things To Know Before Starting Your Vehicle” for further information.

### **Sound Horn With Remote Key Lock**

This feature will cause the horn to chirp when the doors are locked with the RKE transmitter. This feature can be turned on or turned off. To change the current setting, refer to “Uconnect® Settings” in “Understanding Your Instrument Panel” for further information.

### **To Unlatch The Trunk**

Press the TRUNK button on the RKE transmitter two times within five seconds to unlatch the trunk.

If the vehicle is equipped with Passive Entry, refer to Keyless Enter-N-Go™ under “Things To Know Before Starting Your Vehicle” for further information.

### **Using The Panic Alarm**

To turn the Panic Alarm feature on or off, press and hold the PANIC button on the RKE transmitter for at least one second and release. When the Panic Alarm is on, the

headlights will turn on, the park lights and turn signals will flash, the horn will pulse on and off, and the interior lights will turn on.

The Panic Alarm will stay on for three minutes unless you turn it off by either pressing the PANIC button a second time or drive the vehicle at a speed of 15 mph (24 km/h) or greater.

**NOTE:**

- The interior lights will turn off if you cycle the ignition switch to the ACC or ON/RUN position while the Panic Alarm is activated. However, the exterior lights and horn will remain on.
- You may need to be less than 35 ft (11 m) from the vehicle when using the RKE transmitter to turn off the Panic Alarm due to the radio frequency noises emitted by the system.

## Programming Additional Transmitters

Programming Key Fobs or RKE transmitters may be performed at an authorized dealer.

## Transmitter Battery Replacement

The recommended replacement battery is CR2032.

**NOTE:** Perchlorate Material – special handling may apply. See [www.dtsc.ca.gov/hazardouswaste/perchlorate](http://www.dtsc.ca.gov/hazardouswaste/perchlorate)

1. If the RKE transmitter is equipped with a screw, remove the screw. With the RKE transmitter buttons facing down, use a flat blade to pry the two halves of the RKE transmitter apart. Make sure not to damage the elastomer seal during removal.
2. Remove and replace the battery. When replacing the battery, match the + sign on the battery to the + sign on the inside of the battery clip, located on the back cover.

## 28 THINGS TO KNOW BEFORE STARTING YOUR VEHICLE

Avoid touching the new battery with your fingers. Skin oils may cause battery deterioration. If you touch a battery, clean it with rubbing alcohol.

3. To reassemble the RKE transmitter case, snap the two halves of the case together. Make sure there is an even “gap” between the two halves. If equipped, install and tighten the screw until snug. Test RKE transmitter operation.

### General Information

This device complies with Part 15 of the FCC rules and RSS 210 of Industry Canada. Operation is subject to the following conditions:

- This device may not cause harmful interference.
- This device must accept any interference received, including interference that may cause undesired operation.

**NOTE:** Changes or modifications not expressly approved by the party responsible for compliance could void the user’s authority to operate the equipment.

If your RKE transmitter fails to operate from a normal distance, check for these two conditions:

1. A weak battery in the transmitter. The expected life of the battery is a minimum of three years.
2. Closeness to a radio transmitter such as a radio station tower, airport transmitter, and some mobile or CB radios.

### REMOTE STARTING SYSTEM — IF EQUIPPED

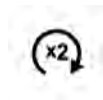

This system uses the Key Fob with Remote Keyless Entry (RKE) transmitter to start the engine conveniently from outside the vehicle while still maintaining security. The system has a range of approximately 300 ft (91 m).

**NOTE:**

- The vehicle must be equipped with an automatic transmission to be equipped with Remote Start.
- Obstructions between the vehicle and the Key Fob may reduce this range.

**How To Use Remote Start**

All of the following conditions must be met before the engine will remote start:

- Shift lever in PARK
- Doors closed
- Hood closed
- Trunk closed
- Hazard switch off
- Brake switch inactive (brake pedal not pressed)

- Battery at an acceptable charge level
- RKE panic button not pressed
- System not disabled from previous remote start event
- Vehicle theft alarm not active
- Ignition in OFF position

**WARNING!**

- **Do not start or run an engine in a closed garage or confined area. Exhaust gas contains Carbon Monoxide (CO) which is odorless and colorless. Carbon Monoxide is poisonous and can cause serious injury or death when inhaled.**
- **Keep Remote Keyless Entry (RKE) transmitters away from children. Operation of the Remote Start System, windows, door locks or other controls could cause serious injury or death.**

### Remote Start Abort Message On Electronic Vehicle Information Center (EVIC) — If Equipped

The following messages will display in the EVIC if the vehicle fails to remote start or exits remote start prematurely:

- Remote Start Aborted — Door Open
- Remote Start Aborted — Hood Open
- Remote Start Aborted — Trunk Open
- Remote Start Aborted — Fuel Low
- Remote Start Disabled — Start To Reset
- Remote Start Aborted — Too Cold
- Remote Start Aborted — Time Expired

The EVIC message stays active until the ignition is cycled to the ON/RUN position.

### To Enter Remote Start Mode

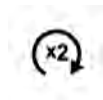

Press and release the REMOTE START button on the RKE transmitter twice within five seconds. The vehicle doors will lock, parking lights will flash and the horn will chirp twice (if programmed). Then, the engine will start and the vehicle will remain in the Remote Start mode for a 15-minute cycle.

#### NOTE:

- If an engine fault is present or fuel level is low, the vehicle will start and then shut down in 10 seconds.
- The park lamps will turn on and remain on during Remote Start mode.



- For security, power window and power sunroof operation (if equipped) are disabled when the vehicle is in the Remote Start mode.
- The engine can be started two consecutive times (two 15-minute cycles) with the RKE transmitter. However, the ignition must be cycled to the RUN position before you can repeat the start sequence for a third cycle.

### To Exit Remote Start Mode Without Driving The Vehicle

Press and release the REMOTE START button one time or allow the engine to run for the entire 15-minute cycle.

**NOTE:** To avoid unintentional shutdowns, the system will disable the one time press of the REMOTE START button for two seconds after receiving a valid Remote Start request.

### To Exit Remote Start Mode And Drive The Vehicle

Before the end of 15-minute cycle, press and release the UNLOCK button on the RKE transmitter to unlock the doors and disarm the Vehicle Security Alarm (if equipped). Then, prior to the end of the 15-minute cycle, press and release the START/STOP button (vehicles equipped with Keyless Enter-N-Go™) or insert the key and turn it to the RUN position (vehicles not equipped with Keyless Enter-N-Go™).

**NOTE:** The message "Remote Start Active Push Start Button" (vehicles equipped with Keyless Enter-N-Go™) or "Remote Start Active Key to Run" (vehicles not equipped with Keyless Enter-N-Go™) will display in the EVIC until you push the START button or turn the key to the RUN position.

## DOOR LOCKS

### Manual Door Locks

To lock each door, rotate the door lock knob on each door trim panel forward. To unlock the front doors, pull the inside door handle to the first detent or rotate the door lock button until the red indicator is visible. To unlock the rear doors, rotate the door lock button until the red indicator is visible.



**Door Lock Knob**

If the door lock button is locked (no red indicator visible) when you shut the door, the door will lock. Therefore, make sure the Key Fob is not inside the vehicle before closing the door.

**WARNING!**

- For personal security and safety in the event of an collision, lock the vehicle doors as you drive as well as when you park and leave the vehicle.
- Never leave children alone in a vehicle, or with access to an unlocked vehicle. Allowing children to be in a vehicle unattended is dangerous for a number of reasons. A child or others could be seriously or fatally injured. Children should be warned not to touch the parking brake, brake pedal or the shift lever.
- Do not leave the Key Fob in or near the vehicle, or in a location accessible to children, and do not leave the ignition of a vehicle equipped with Keyless Enter-N-Go™ in the ACC or ON/RUN mode. A child could operate power windows, other controls, or move the vehicle.

**Power Door Locks**

A power door lock switch is on each front door trim panel. Use this switch to lock or unlock the doors.



Power Door Lock Switch

The doors can also be locked and unlocked with the Keyless Enter-N-Go™ (Passive Entry) system. For further information, refer to “Keyless Enter-N-Go™” in “Things To Know Before Starting Your Vehicle”.

If you press the power door lock switch while the key is in the ignition, and any front door is open, the power locks will not operate. This prevents you from accidentally locking the Key Fob in the vehicle. Removing the key from the ignition or closing the door will allow the locks to operate. If a door is open, and the ignition is in the ACC or ON/RUN position, a chime will sound as a reminder to remove the Key Fob.

### **Automatic Door Locks — If Equipped**

The auto door lock feature default condition is enabled. When enabled, the door locks will lock automatically when the vehicle’s speed exceeds 15 mph (24 km/h).

The auto door lock feature can be enabled or disabled by your authorized dealer per written request of the customer. Please see your authorized dealer for service.

### **Automatic Unlock Doors On Exit**

The doors will unlock automatically on vehicles with power door locks if:

1. The Automatic Unlock Doors On Exit feature is enabled.
2. The transmission was in gear and the vehicle speed returned to 0 mph (0 km/h).
3. The transmission is in NEUTRAL or PARK.
4. Any door is opened.
5. The doors were not previously unlocked.
6. The vehicle speed is 0 mph (0 km/h).

## Automatic Unlock Doors On Exit Programming

To change the current setting, refer to “Uconnect® Settings” in “Understanding Your Instrument Panel” for further information.

**NOTE:** Use the Automatic Unlock Doors On Exit feature in accordance with local laws.

## Child-Protection Door Lock System — Rear Doors

To provide a safer environment for small children riding in the rear seats, the rear doors are equipped with Child-Protection Door Lock system.

### To Engage Or Disengage The Child-Protection Door Lock System

1. Open the rear door.
2. Insert the tip of the emergency key or a small coin into the lock and rotate to the LOCK or UNLOCK position.
3. Repeat steps 1 and 2 for the opposite rear door.



Child-Protection Door Lock Function

### WARNING!

Avoid trapping anyone in a vehicle in a collision. Remember that the rear doors can only be opened from the outside when the Child-Protection locks are engaged (locked).

**NOTE:** For emergency exit from the rear seats when the Child-Protection Door Lock System is engaged, manually rotate the door lock button to the unlocked position, roll down the window, and open the door using the outside door handle.

### **KEYLESS ENTER-N-GO™**

The Passive Entry system is an enhancement to the vehicle's Remote Keyless Entry (RKE) system and a feature of Keyless Enter-N-Go™. This feature allows you to lock and unlock the vehicle's door(s) without having to press the RKE transmitter lock or unlock buttons.

**NOTE:**

- Passive Entry may be programmed ON/OFF; refer to "Uconnect® Settings" in "Understanding Your Instrument Panel" for further information.

- If wearing gloves on your hands, or if it has been raining on the Passive Entry door handle, the unlock sensitivity can be affected, resulting in a slower response time.
- If the vehicle is unlocked by Passive Entry and no door goes ajar within 60 seconds, the vehicle will re-lock and if equipped will arm the security alarm.

### **To Unlock From The Driver's Side:**

With a valid Passive Entry RKE transmitter within 5 ft (1.5 m) of the driver's door handle, grab the front driver door handle to unlock the driver's door automatically. The interior door panel lock knob will raise when the door is unlocked.

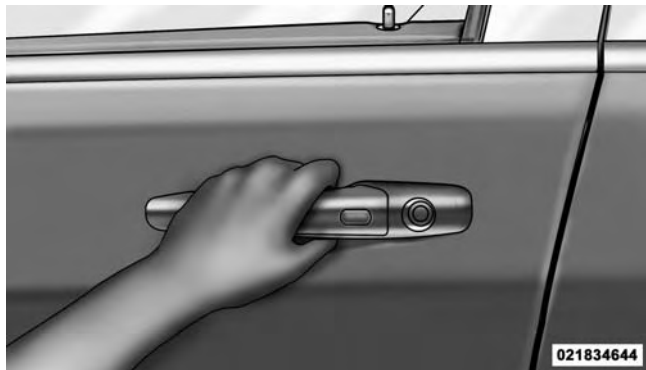

### Grab The Door Handle To Unlock

**NOTE:** If “Unlock All Doors 1st Press” is programmed all doors will unlock when you grab hold of the front driver’s door handle. To select between “Unlock Driver Door 1st Press” and “Unlock All Doors 1st Press”, refer to “Uconnect® Settings” in “Understanding Your Instrument Panel” for further information.

### To Unlock From The Passenger Side:

With a valid Passive Entry RKE transmitter within 5 ft (1.5 m) of the passenger door handle, grab the front passenger door handle to unlock all four doors automatically. The interior door panel lock knob will raise when the door is unlocked.

**NOTE:** All doors will unlock when the front passenger door handle is grabbed regardless of the driver’s door unlock preference setting (“Unlock Driver Door 1st Press” or “Unlock All Doors 1st Press”).

### Preventing Inadvertent Locking Of Passive Entry RKE Transmitter In Vehicle

To minimize the possibility of unintentionally locking a Passive Entry RKE transmitter inside your vehicle, the Passive Entry system is equipped with an automatic door unlock feature which will function if the ignition switch is in the OFF position.

If one of the vehicle doors is open and the door panel switch is used to lock the vehicle, once all open doors have been closed the vehicle checks the inside and outside of the vehicle for any valid Passive Entry RKE transmitters. If one of the vehicle's Passive Entry RKE transmitters is detected inside the vehicle, and no other valid Passive Entry RKE transmitters are detected outside the vehicle, the Passive Entry System automatically unlocks all vehicle doors and chirps the horn three times (on the third attempt ALL doors will lock and the Passive Entry RKE transmitter can be locked in the vehicle).

**NOTE:** The vehicle will only unlock the doors when the doors are locked using the door panel switch, a valid Passive Entry RKE transmitter is detected inside the

vehicle, and no valid Passive Entry RKE transmitter is detected outside the vehicle. The vehicle will not unlock the doors when any of the following conditions are true:

- The doors are locked using the RKE transmitter.
- The doors are locked using the LOCK button on the Passive Entry door handles.
- The doors are manually locked using the door lock knobs.
- There is a valid Passive Entry RKE transmitter outside the vehicle and within 5 ft (1.5 m) of either Passive Entry door handle.
- Three attempts are made to lock the doors using the door panel switch and then close the doors.



## To Enter The Trunk

With a valid Passive Entry RKE transmitter within 3 ft (1.0 m) of the deck lid, press the button on the right side of CHMSL, (Center High Mounted Stop Light) which is located on the deck lid.



Trunk Unlock Button

**NOTE:** If you inadvertently leave your vehicle's Passive Entry RKE transmitter in the trunk and try to close the trunk lid, the trunk lid will automatically unlatch, unless another one of the vehicle's Passive Entry RKE transmitters is outside the vehicle and within 3 ft (1.0 m) of the deck lid.

## To Lock The Vehicle's Doors

With one of the vehicle's Passive Entry RKE transmitters within 5 ft (1.5 m) of the driver or passenger front door handles, press the door handle LOCK button to lock all four doors.

#### 40 THINGS TO KNOW BEFORE STARTING YOUR VEHICLE

Do NOT grab the door handle, when pressing the door handle lock button. This could unlock the door(s).

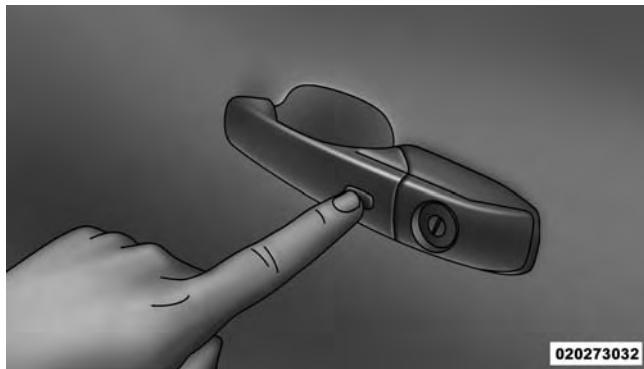

Press The Door Handle Button To Lock



Do NOT Grab The Handle When Locking

**NOTE:**

- After pressing the door handle LOCK button, you must wait two seconds before you can lock or unlock the doors, using either Passive Entry door handle. This is done to allow you to check if the vehicle is locked by pulling the door handle, without the vehicle reacting and unlocking.
- The Passive Entry system will not operate if the RKE transmitter battery is dead.

The vehicle doors can also be locked by using the RKE transmitter lock button or the lock button located on the vehicle's interior door panel.

**WINDOWS****Power Windows**

The window controls on the driver's door control all the door windows.



Power Window Switches

There are single window controls on each passenger door trim panel, which operate the passenger door windows. The window controls will operate only when the ignition is in the ACC or ON/RUN position.

**NOTE:** For vehicles equipped with the Uconnect®, the power window switches will remain active for up to 10 minutes after the ignition is cycled to the OFF position. Opening either front door will cancel this feature. The time is programmable. Refer to “Uconnect® Settings” in “Understanding Your Instrument Panel” for further information.

**WARNING!**

**Never leave children unattended in a vehicle, and do not let children play with power windows. Do not leave the Key Fob in or near the vehicle, or in a location accessible to children, and do not leave the ignition of a vehicle equipped with Keyless Enter-N-Go™ in the ACC or ON/RUN mode. Occupants, particularly unattended children, can become entrapped by the windows while operating the power window switches. Such entrapment may result in serious injury or death.**

**Driver One Touch Down**

The driver door power window switch has an auto down feature. Press the window switch to the second detent and release, and the window will go down automatically.

To open the window part way, press the window switch to the first detent and release it when you want the window to stop.

To stop the window from going all the way down during the Auto Down operation, pull up on the switch briefly.

### Front Windows Express Up And Down — If Equipped

#### Express Down

Press the switch for less than a half a second and release. The window will go down automatically.

#### Manual Down

Press the switch for more than a half a second and release when you want the window to stop.

#### Express Up

Lift the switch for less than a half a second and release. The window will go up automatically.

#### Manual Up

Lift the switch for more than a half a second and release when you want the window to stop.

#### NOTE:

- If the window runs into any obstacle during auto-closure, it will reverse direction and then go back down. Remove the obstacle and use the window switch again to close the window.
- Any impact due to rough road conditions may trigger the auto-reverse function unexpectedly during auto-closure. If this happens, pull the switch lightly to the first detent and hold to close the window manually.

#### **WARNING!**

**There is no anti-pinch protection when the window is almost closed. Be sure to clear all objects from the window before closing.**

## Reset Auto-Up

Should the Auto Up feature stop working, the window may need to be reset. To reset Auto Up:

1. Make sure the door is fully closed.
2. Pull the window switch up to close the window completely and continue to hold the switch up for an additional two seconds after the window is closed.
3. Push the window switch down firmly to the second detent to open the window completely and continue to hold the switch down for an additional two seconds after the window is fully open.

## Window Lockout Switch

The window lockout switch on the driver's door trim panel allows you to disable the window controls on the rear passenger doors. To disable the window controls,

press and release the window lockout button (setting it in the DOWN position). To enable the window controls, press and release the window lockout button again (setting it in the UP position).



Window Lockout Switch

## Wind Buffeting

Wind buffeting can be described as the perception of pressure on the ears or a helicopter-type sound in the ears. Your vehicle may exhibit wind buffeting with the windows down, or the sunroof (if equipped) in certain open or partially open positions. This is a normal occurrence and can be minimized. If the buffeting occurs with the rear windows open, then open the front and rear windows together to minimize the buffeting. If the buffeting occurs with the sunroof open, adjust the sunroof opening to minimize the buffeting.

## TRUNK LOCK AND RELEASE



The trunk lid can be released from inside the vehicle by pressing the TRUNK RELEASE button located on the instrument panel to the left of the steering wheel.

2

**NOTE:** The transmission must be in PARK before the button will operate.

The trunk lid can be released from outside the vehicle by pressing the TRUNK button on the Remote Keyless Entry (RKE) transmitter twice within five seconds or by using the external release switch located on the underside of the decklid overhang. The release feature will function only when the vehicle is in the unlock condition.

With the ignition in the ON/RUN position, the Trunk Open symbol will display in the instrument cluster indicating that the trunk is open. The odometer display will reappear once the trunk is closed.

With the ignition in the OFF position, the Trunk Open symbol will display until the trunk is closed.

Refer to “Keyless Enter-N-Go™” in “Things To Know Before Starting Your Vehicle” for more information on trunk operation with the Passive Entry feature.

## TRUNK SAFETY WARNING

### WARNING!

**Do not allow children to have access to the trunk, either by climbing into the trunk from outside, or through the inside of the vehicle. Always close the trunk lid when your vehicle is unattended. Once in the trunk, young children may not be able to escape, even if they entered through the rear seat. If trapped in the trunk, children can die from suffocation or heat stroke.**

## Trunk Emergency Release

As a security measure, a trunk internal emergency release lever is built into the trunk latching mechanism. In the event of an individual being locked inside the trunk,



the trunk can be simply opened by pulling on the glow-in-the-dark handle attached to the trunk latching mechanism.

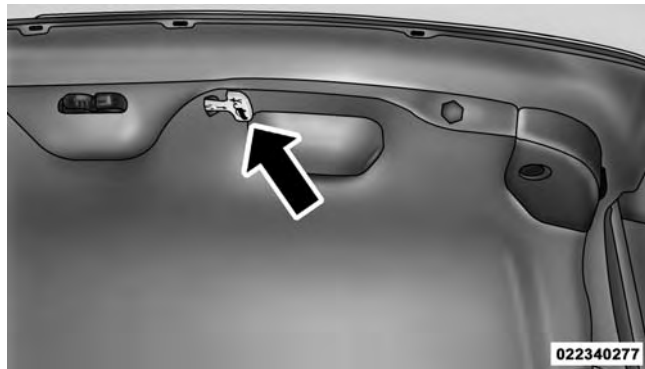

Trunk Emergency Release

## OCCUPANT RESTRAINTS

Some of the most important safety features in your vehicle are the restraint systems:

- Three-point lap and shoulder belts for the driver and all passengers
- Advanced Front Air Bags for driver and front passenger
- An energy-absorbing steering column and steering wheel
- Supplemental Side Air Bag Inflatable Curtains (SABIC) for the driver and passengers seated next to a window
- Supplemental Seat-Mounted Side Air Bags (SAB)
- Supplemental Driver Side and Passenger Knee Airbags
- Knee bolsters/blockers for front seat occupant

## 48 THINGS TO KNOW BEFORE STARTING YOUR VEHICLE

- Front seat belts incorporate pretensioners and load limiters that may enhance occupant protection by managing occupant energy during an impact event
- All seat belt systems (except the driver's) include Automatic Locking Retractors (ALRs), which lock the seat belt webbing into position by extending the belt all the way out and then adjusting the belt to the desired length to restrain a child seat or secure a large item in a seat — if equipped

Please pay close attention to the information in this section. It tells you how to use your restraint system properly, to keep you and your passengers as safe as possible.

If you will be carrying children too small for adult-sized seat belts, the seat belts or the Lower Anchors and Tether for Children (LATCH) feature also can be used to hold infant and child restraint systems. For more information on LATCH, refer to Lower Anchors and Tether for Children (LATCH).

**NOTE:** The Advanced Front Air Bags have a multistage inflator design. This allows the air bag to have different rates of inflation based on several factors, including the severity and type of collision.

Here are some simple steps you can take to minimize the risk of harm from a deploying air bag:

1. **Children 12 years old and under should always ride buckled up in a rear seat.**

**WARNING!**

- **Never place a rear facing infant seat in front of an air bag. A deploying Passenger Advanced Front Air Bag can cause death or serious injury to a child 12 years or younger, including a child in a rearward facing infant seat.**
- **Only use a rearward-facing child restraint in a vehicle with a rear seat.**

Children that are not big enough to wear the vehicle seat belt properly (see section on Child Restraints) should be secured in the rear seat in child restraints or belt-positioning booster seats. Older children who do not use child restraints or belt-positioning booster seats should ride properly buckled up in the rear seat. Never allow children to slide the shoulder belt behind them or under their arm.

If a child from 2 to 12 years old (not in a rear facing child seat) must ride in the front passenger seat, move the seat as far back as possible and use the proper child restraint. Refer to “Child Restraints”.

You should read the instructions provided with your child restraint to make sure that you are using it properly.

2. **All occupants should always wear their lap and shoulder belts properly.**
3. **The driver and front passenger seats should be moved back as far as practical to allow the Advanced Front Air Bags room to inflate.**
4. **Do not lean against the door or window. If your vehicle has side air bags, and deployment occurs, the side air bags will inflate forcefully into the space between you and the door.**

5. If the air bag system in this vehicle needs to be modified to accommodate a disabled person, contact the Customer Center. Phone numbers are provided under "If You Need Assistance".

**WARNING!**

- Relying on the air bags alone could lead to more severe injuries in a collision. The air bags work with your seat belt to restrain you properly. In some collisions, the air bags won't deploy at all. Always wear your seat belts even though you have air bags.
- Being too close to the steering wheel or instrument panel during Advanced Front Air Bag deployment could cause serious injury, including death. Air bags need room to inflate. Sit back, comfortably extending your arms to reach the steering wheel or instrument panel.

**WARNING! (Continued)**

- Supplemental Side Air Bag Inflatable Curtain (SABIC) and Seat-Mounted Side Air Bags (SAB) also need room to inflate. Do not lean against the door or window. Sit upright in the center of the seat.
- In a collision, you and your passengers can suffer much greater injuries if you are not properly buckled up. You can strike the interior of your vehicle or other passengers, or you can be thrown out of the vehicle. Always be sure you and others in your vehicle are buckled up properly.
- Being too close to the Supplemental Side Air Bag Inflatable Curtain (SABIC) and/or Seat-Mounted Side Air Bag (SAB) during deployment could cause you to be severely injured or killed.

*(Continued)*

Buckle up even though you are an excellent driver, even on short trips. Someone on the road may be a poor driver and cause a collision that includes you. This can happen far away from home or on your own street.

Research has shown that seat belts save lives, and they can reduce the seriousness of injuries in a collision. Some of the worst injuries happen when people are thrown from the vehicle. Seat belts reduce the possibility of ejection and the risk of injury caused by striking the inside of the vehicle. Everyone in a motor vehicle should be belted at all times.

### **Lap/Shoulder Belts**

All seating positions in your vehicle are equipped with lap/shoulder belts.

The belt webbing retractor is designed to lock during very sudden stops or impacts. This feature allows the shoulder part of the belt to move freely with you under normal conditions. However, in a collision, the belt will lock and reduce your risk of striking the inside of the vehicle or being thrown out.

#### **WARNING!**

- **Do not allow people to ride in any area of your vehicle that is not equipped with seats and seat belts.**
- **Be sure everyone in your vehicle is in a seat and using a seat belt properly.**
- **Wearing a seat belt incorrectly is dangerous. Seat belts are designed to go around the large bones of your body. These are the strongest parts of your body and can take the forces of a collision best.**

*(Continued)*

**WARNING! (Continued)**

- Wearing your belt in the wrong place could make your injuries in a collision much worse. You might suffer internal injuries, or you could even slide out of part of the belt. Follow these instructions to wear your seat belt safely and to keep your passengers safe, too.
- Two people should never be belted into a single seat belt. People belted together can crash into one another in a collision, hurting one another badly. Never use a lap/shoulder belt or a lap belt for more than one person, no matter what their size.

**Lap/Shoulder Belt Operating Instructions**

1. Enter the vehicle and close the door. Sit back and adjust the front seat.

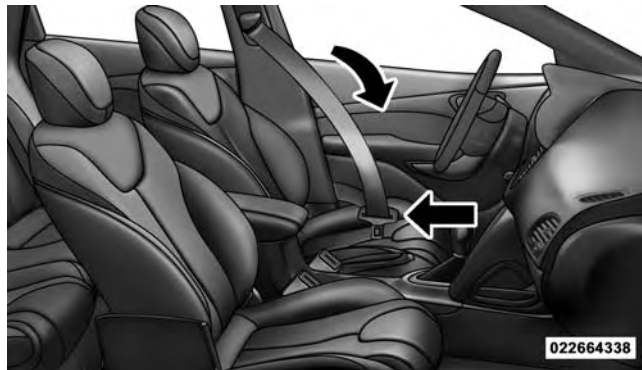

**Pulling Out The Lap/Shoulder Belt Latch Plate**

2. The seat belt latch plate is above the back of your seat. Grasp the latch plate and pull out the belt. Slide the latch plate up the webbing as far as necessary to make the belt go around your lap.
3. When the belt is long enough to fit, insert the latch plate into the buckle until you hear a “click.”



Inserting Latch Plate Into Buckle

## WARNING!

- A belt that is buckled into the wrong buckle will not protect you properly. The lap portion could ride too high on your body, possibly causing internal injuries. Always buckle your belt into the buckle nearest you.
- A belt that is too loose will not protect you properly. In a sudden stop you could move too far forward, increasing the possibility of injury. Wear your seat belt snugly.
- A belt that is worn under your arm is dangerous. Your body could strike the inside surfaces of the vehicle in a collision, increasing head and neck injury. A belt worn under the arm can cause internal injuries. Ribs aren't as strong as shoulder bones. Wear the belt over your shoulder so that your strongest bones will take the force in a collision.

**WARNING! (Continued)**

- A shoulder belt placed behind you will not protect you from injury during a collision. You are more likely to hit your head in a collision if you do not wear your shoulder belt. The lap and shoulder belt are meant to be used together.

4. Position the lap belt across your thighs, below your abdomen. To remove slack in the lap belt portion, pull up a bit on the shoulder belt. To loosen the lap belt if it is too tight, tilt the latch plate and pull on the lap belt. A snug belt reduces the risk of sliding under the belt in a collision.



Removing Slack From Belt



**WARNING!**

- A lap belt worn too high can increase the risk of injury in a collision. The belt forces won't be at the strong hip and pelvic bones, but across your abdomen. Always wear the lap part of your seat belt as low as possible and keep it snug.
  - A twisted belt may not protect you properly. In a collision, it could even cut into you. Be sure the belt is straight. If you can't straighten a belt in your vehicle, take it to your authorized dealer immediately and have it fixed.
5. Position the shoulder belt on your chest so that it is comfortable and not resting on your neck. The retractor will withdraw any slack in the belt.

6. To release the belt, push the red button on the buckle. The belt will automatically retract to its stowed position. If necessary, slide the latch plate down the webbing to allow the belt to retract fully.

**WARNING!**

A frayed or torn belt could rip apart in a collision and leave you with no protection. Inspect the belt system periodically, checking for cuts, frays, or loose parts. Damaged parts must be replaced immediately. Do not disassemble or modify the system. Seat belt assemblies must be replaced after a collision if they have been damaged (bent retractor, torn webbing, etc.) or if the air bag deployed.

### Adjustable Upper Shoulder Belt Anchorage

In the driver and front passenger seats, the shoulder belt can be adjusted upward or downward to position the belt away from your neck. Push and fully depress the button above the webbing to release the anchorage, then move it up or down to the position that fits you best.

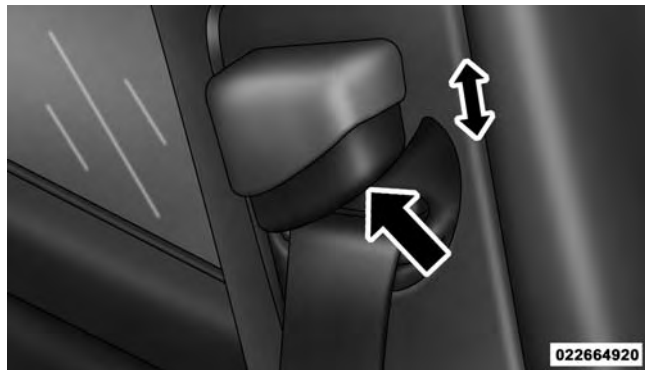

Adjusting Upper Shoulder Belt

As a guide, if you are shorter than average you will prefer a lower position, and if you are taller than average you will prefer a higher position. When you release the anchorage try to move it up and down to make sure that it is locked in position.

In the rear seat, move toward the center of the seat to position the belt away from your neck.

### Lap/Shoulder Belt Untwisting Procedure

Use the following procedure to untwist a twisted lap/shoulder belt.

1. Position the latch plate as close as possible to the anchor point.
2. At about 6 to 12 in (15 to 30 cm) above the latch plate, grasp and twist the belt webbing 180 degrees to create a fold that begins immediately above the latch plate.

- Slide the latch plate upward over the folded webbing. The folded webbing must enter the slot at the top of the latch plate.
- Continue to slide the latch plate up until it clears the folded webbing.

### Seat Belts In Passenger Seating Positions

The seat belts in the passenger seating positions are equipped with Automatic Locking Retractors (ALR) which are used to secure a child restraint system. For additional information, refer to “Installing Child Restraints Using The Vehicle Seat Belt” under the “Child Restraints” section. The chart below defines the type of feature for each seating position.

	Driver	Center	Passenger
First Row	N/A	N/A	ALR
Second Row	ALR	ALR	ALR

- N/A — Not Applicable
- ALR — Automatic Locking Retractor

If the passenger seating position is equipped with an ALR and is being used for normal usage:

Only pull the belt webbing out far enough to comfortably wrap around the occupant’s mid-section so as to not activate the ALR. If the ALR is activated, you will hear a ratcheting sound as the belt retracts. Allow the webbing to retract completely in this case and then carefully pull out only the amount of webbing necessary to comfortably wrap around the occupant’s mid-section. Slide the latch plate into the buckle until you hear a “click”.

### **Automatic Locking Retractor Mode (ALR) — If Equipped**

In this mode, the shoulder belt is automatically pre-locked. The belt will still retract to remove any slack in the shoulder belt. The Automatic Locking Mode is available on all passenger-seating positions with a combination lap/shoulder belt. Use the Automatic Locking Mode anytime a child safety seat is installed in a seating position that has a belt with this feature. Children 12 years old and under should always be properly restrained in a vehicle with a rear seat.

#### **How To Engage The Automatic Locking Mode**

1. Buckle the combination lap and shoulder belt.
2. Grasp the shoulder portion and pull downward until the entire belt is extracted.
3. Allow the belt to retract. As the belt retracts, you will hear a clicking sound. This indicates the safety belt is now in the Automatic Locking Mode.

#### **How To Disengage The Automatic Locking Mode**

Unbuckle the combination lap/shoulder belt and allow it to retract completely to disengage the Automatic Locking Mode and activate the vehicle sensitive (emergency) locking mode.

#### **WARNING!**

- **The belt and retractor assembly must be replaced if the seat belt assembly Automatic Locking Retractor (ALR) feature or any other seat belt function is not working properly when checked according to the procedures in the Service Manual.**
- **Failure to replace the belt and retractor assembly could increase the risk of injury in collisions.**

## Energy Management Feature

This vehicle has a safety belt system with an Energy Management feature in the front seating positions to help further reduce the risk of injury in the event of a head-on collision.

This safety belt system has a retractor assembly that is designed to release webbing in a controlled manner. This feature is designed to help reduce the belt force acting on the occupant's chest.

## Belt Pretensioning And Load Limitation

The driver and passenger front seating positions are equipped with seat belt systems that may incorporate retractor pretensioning devices, anchor/buckle pretensioning devices, and load limiting devices. These devices are designed to remove any slack from the seat belt systems in the event of a collision. These devices may improve the performance of the seat belt by assuring that

the belt is tight around the occupant early in a collision. Pretensioners work for all size occupants, including those in child restraints.

**NOTE:** These devices are not a substitute for proper seat belt placement by the occupant. The seat belt must still be worn snugly and positioned properly.

The pretensioners are triggered by the Occupant Restraint Controller (ORC). Like the air bags, the pretensioners are single use items. A deployed pretensioner or a deployed air bag must be replaced immediately.

## Enhanced Seat Belt Use Reminder System (BeltAlert®)

BeltAlert® is a feature intended to remind the driver and front passenger (if equipped with front passenger BeltAlert®) to fasten their seat belts. The feature is active whenever the ignition is on. If the driver or front seat

passenger is unbelted, the Seat Belt Reminder Light will turn on and remain on until both front seat belts are fastened.

The BeltAlert® warning sequence begins after the vehicle speed is over 5 mph (8 km/h), by blinking the Seat Belt Reminder Light and sounding an intermittent chime. Once the sequence starts, it will continue for the entire duration or until the respective seatbelts are fastened. After the sequence completes, the Seat Belt Reminder Light remains illuminated until the respective seat belts are fastened. The driver should instruct all other occupants to fasten their seat belts. If a front seat belt is unbuckled while traveling at speeds greater than 5 mph (8 km/h), BeltAlert® will provide both audio and visual notification.

The front passenger seat BeltAlert® is not active when the front passenger seat is unoccupied. BeltAlert® may be triggered when an animal or heavy object is on the front passenger seat or when the seat is folded flat (if equipped).

It is recommended that pets be restrained in the rear seat (if equipped) in pet harnesses or pet carriers that are secured by seat belts, and cargo is properly stowed.

BeltAlert® can be enabled or disabled by your authorized dealer. Chrysler Group LLC does not recommend deactivating BeltAlert®.

**NOTE:** Although BeltAlert® has been deactivated, the Seat Belt Reminder Light will continue to illuminate while the driver's or front passenger (if equipped with BeltAlert®) seat belt remains unfastened.

### **Seat Belts And Pregnant Women**

We recommend that pregnant women use the seat belts throughout their pregnancy. Keeping the mother safe is the best way to keep the baby safe.

Pregnant women should wear the lap part of the belt across the thighs and as snug across the hips as possible. Keep the belt low so that it does not come across the abdomen. That way the strong bones of the hips will take the force if there is a collision.

### **Seat Belt Extender**

If a seat belt is too short even when fully extended and when the adjustable upper shoulder belt anchorage (if so equipped) is in its lowest position, your authorized dealer can provide you with a seat belt extender. This extender should be used only if the existing belt is not long enough. When it is not required, remove the extender and store it.

### **WARNING!**

**Using a seat belt extender when not needed can increase the risk of injury in a collision. Only use when the seat belt is not long enough when it is worn low and snug, and in the recommended seating positions. Remove and store the extender when not needed.**

### **Supplemental Restraint System (SRS) — Air Bags**

This vehicle has Advanced Front Air Bags for both the driver and front passenger as a supplement to the seat belt restraint systems. The driver's Advanced Front Air Bag is mounted in the center of the steering wheel. The passenger's Advanced Front Air Bag is mounted in the instrument panel, above the glove compartment. The words SRS AIRBAG are embossed on the air bag covers.

## 62 THINGS TO KNOW BEFORE STARTING YOUR VEHICLE

In addition, the vehicle is equipped with a Supplemental Driver Side Knee Air Bag mounted in the instrument panel below the steering column.

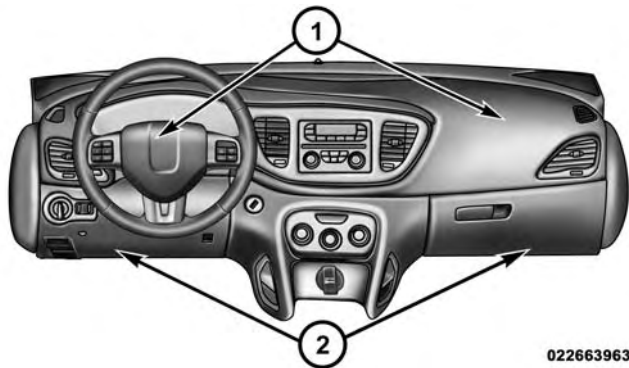

### Advanced Front Air Bag And Knee Bolster Locations

1 — Driver And Passenger  
Advanced Front Air Bags

2 — Supplemental Driver And  
Passenger Side Knee Air Bags/  
Knee Bolsters

**NOTE:** The Driver and Passenger Advanced Front Air Bags are certified to new Federal regulations.

The Advanced Front Air Bags have a multistage inflator design. This allows the air bag to have different rates of inflation based on several factors, including the severity and type of collision.

This vehicle may be equipped with driver and/or front passenger seat track position sensors that may adjust the inflation rate of the Advanced Front Air Bags based upon seat position.

This vehicle may be equipped with a driver and/or front passenger seat belt buckle switch that detects whether the driver or front passenger seat belt is fastened. The seat belt buckle switch may adjust the inflation rate of the Advanced Front Air Bags.



This vehicle may be equipped with a front passenger occupant classification system (OCS) that may adjust the inflation rate of the Passenger Advanced Front Air Bag based upon occupant weight.

This vehicle is equipped with Supplemental Side Air Bag Inflatable Curtains (SABIC) to protect the driver, front, and rear passengers sitting next to a window. The SABIC air bags are located above the side windows and their covers are also labeled: SRS AIRBAG.

This vehicle is equipped with Supplemental Seat-Mounted Side Air Bags (SAB) to provide enhanced protection for an occupant during a side impact. The Supplemental Seat-Mounted Side Air Bags are located in the outboard side of the front seats and the rear seats (if equipped with rear seat SAB).

**NOTE:**

- Air Bag covers may not be obvious in the interior trim, but they will open during air bag deployment.

- After any collision, the vehicle should be taken to an authorized dealer immediately.

### Air Bag System Components

Your vehicle may be equipped with the following air bag system components:

- Occupant Restraint Controller (ORC)
- Air Bag Warning Light 
- Steering Wheel and Column
- Instrument Panel
- Supplemental Driver Side Knee Air Bag
- Knee Impact Bolsters
- Driver Advanced Front Air Bag
- Passenger Advanced Front Air Bag
- Supplemental Seat-Mounted Side Air Bags (SAB)

- Supplemental Side Air Bag Inflatable Curtains (SABIC)
- Front and Side Impact Sensors
- Front Seat Belt Pretensioners, Seat Belt Buckle Switch, and
- Occupant Classification System (OCS)

### **Advanced Front Air Bag Features**

The Advanced Front Air Bag system has multistage driver and front passenger air bags. This system provides output appropriate to the severity and type of collision as determined by the Occupant Restraint Controller (ORC), which may receive information from the front impact sensors.

The first stage inflator is triggered immediately during an impact that requires air bag deployment. This low output is used in less severe collisions. A higher energy output is used for more severe collisions.

### **WARNING!**

- No objects should be placed over or near the air bag on the instrument panel, because any such objects could cause harm if the vehicle is in a collision severe enough to cause the air bag to inflate.
- Do not put anything on or around the air bag covers or attempt to open them manually. You may damage the air bags and you could be injured because the air bags may no longer be functional. The protective covers for the air bag cushions are designed to open only when the air bags are inflating.
- Do not drill, cut or tamper with the knee bolster in any way.
- Do not mount any accessories to the knee bolster such as alarm lights, stereos, citizen band radios, etc.

### **Supplemental Seat-Mounted Side Air Bags (SAB)**

Supplemental Seat-Mounted Side Air Bags (SAB) may provide enhanced protection to help protect an occupant during a side impact. The SAB is marked with an air bag label sewn into the outboard side of the front and rear seats (if equipped with rear seat SAB).

When the air bag deploys, it opens the seam between the front and side of the seat's back trim cover (front seats) or between the top and side seat's cushion trim cover (rear seat). Each air bag deploys independently; a left side impact deploys the left air bags only and a right-side impact deploys the right air bags only.

### **Supplemental Side Air Bag Inflatable Curtain (SABIC)**

SABIC air bags may offer side-impact protection to front and rear seat outboard occupants in addition to that provided by the body structure. Each air bag features inflated chambers placed adjacent to the head of each

outboard occupant that reduce the potential for side-impact head injuries. The SABIC deploys downward, covering both windows on the impact side.

#### **NOTE:**

- Air Bag covers may not be obvious in the interior trim, but they will open during air bag deployment.
- Being too close to the side air bags during deployment could cause you to be severely injured or killed.

The system includes side impact sensors that are calibrated to deploy the side air bags during impacts that require air bag occupant protection.

SAB and SABIC air bags are a supplement to the seat belt restraint system.

Occupants, including children who are up against or very close to SABIC or SAB air bags can be seriously injured or killed.

Occupants, especially children, should not lean on or sleep against the door, side windows, or area where the SABIC or SAB air bags inflate, even if they are in an infant or child restraint.

Always sit upright as possible with your back against the seat back, use the seat belts properly, and use the appropriate sized child restraint, infant restraint or booster seat recommended for the size and weight of the child.

**WARNING!**

- **Your vehicle is equipped with left and right SABIC, do not stack luggage or other cargo up high enough to block the location of the SABIC. The area where the side curtain air bag is located should remain free from any obstructions.**

*(Continued)*

**WARNING! (Continued)**

- **Do not use accessory seat covers or place objects between you and the SAB; the performance could be adversely affected and/or objects could be pushed into you, causing serious injury.**
- **Your vehicle is equipped with SABIC air bags, do not have any accessory items installed which will alter the roof, including adding a sunroof to your vehicle. Do not add roof racks that require permanent attachments (bolts or screws) for installation on the vehicle roof. Do not drill into the roof of the vehicle for any reason.**

**Knee Impact Bolsters**

The Knee Impact Bolsters help protect the knees of the driver and front passenger, and position the front occupants for the best interaction with the Advanced Front Air Bags.

Along with seat belts and pretensioners, Advanced Front Air Bags work with the Supplemental Driver and Passenger Side Knee Air Bags and the knee bolsters to provide improved protection for the driver and front passenger. Side air bags also work with seat belts to improve occupant protection.

## **Air Bag Deployment Sensors And Controls**

### **Occupant Restraint Controller (ORC)**

The ORC is part of a Federally regulated safety system required for this vehicle.

The ORC determines if deployment of the front and/or side air bags in a frontal or side collision is required. Based on the impact sensor's signals, a central electronic ORC deploys the Advanced Front Air Bags, SABIC air bags, SABs, Supplemental Driver Side Knee Air Bag, Supplemental Passenger Side Knee Air Bag, and front seat belt pretensioners, as required, depending on several factors, including the severity and type of impact.

Advanced Front Air Bags and Supplemental Driver and Front Passenger Knee Air Bags are designed to provide additional protection by supplementing the seat belts in certain frontal collisions depending on several factors, including the severity and type of collision. Advanced Front Air Bags and Supplemental Driver and Front Passenger Knee Air Bags are not expected to reduce the risk of injury in rear, side, or rollover collisions.

The Advanced Front Air Bags and Supplemental Driver and Front Passenger Knee Air Bags will not deploy in all frontal collisions, including some that may produce substantial vehicle damage — for example, some pole collisions, truck underrides, and angle offset collisions. On the other hand, depending on the type and location of impact, Advanced Front Air Bags and Supplemental Driver and Front Passenger Knee Air Bags may deploy in crashes with little vehicle front-end damage but that produce a severe initial deceleration.

The side air bags will not deploy in all side collisions. Side air bag deployment will depend on the severity and type of collision.

Because air bag sensors measure vehicle deceleration over time, vehicle speed and damage by themselves are not good indicators of whether or not an air bag should have deployed.

Seat belts are necessary for your protection in all collisions, and also are needed to help keep you in position, away from an inflating air bag.

The ORC monitors the readiness of the electronic parts of the air bag system whenever the ignition is in the START or ON/RUN position. If the ignition is in the OFF position or in the ACC position, the air bag system is not on and the air bags will not inflate.

The ORC contains a backup power supply system that may deploy the air bags even if the battery loses power or it becomes disconnected prior to deployment.



Also, the ORC turns on the Air Bag Warning Light in the instrument panel for approximately four to eight seconds for a self-check when the ignition is first turned on. After the self-check, the Air Bag Warning Light will turn off. If the ORC detects a malfunction in any part of the system, it turns on the Air Bag Warning Light, either momentarily or continuously. A single chime will sound if the light comes on again after initial startup.

It also includes diagnostics that will illuminate the instrument cluster Air Bag Warning Light if a malfunction is noted that could affect the air bag system. The diagnostics also record the nature of the malfunction.

**WARNING!**

Ignoring the Air Bag Warning Light in your instrument panel could mean you won't have the air bags to protect you in a collision. If the light does not come on as a bulb check when the ignition is first turned on, stays on after you start the vehicle, or if it comes on as you drive, have an authorized dealer service the air bag system immediately.

### Occupant Classification System (OCS) — Front Passenger Seat

The OCS is part of a Federally regulated safety system for this vehicle.

The Occupant Classification System (OCS) consists of the following:

- Occupant Restraint Controller (ORC)

- Occupant Classification Module (OCM) located in the front passenger seat
- OCS Sensor located in the front passenger seat
- Air Bag Warning Light 

The OCS will NOT prevent deployment of the passenger Advanced Front Air Bag. The OCS may reduce the inflation rate of the passenger Advanced Front Air Bag if the sensors estimate that:

- The front passenger seat is unoccupied or has very light objects in it; or
- The front passenger seat is occupied by a small passenger, including a child; or
- The front passenger seat is occupied by a rearward facing infant seat; or
- The front passenger is not properly seated or his or her weight is taken off of the seat for a period of time.

Front Passenger Seat Occupant Status	Front Passenger Air Bag Classification
Rearward-facing infant seat*	Reduced-power deployment
Child, including a child in a forward-facing child restraint or booster seat*	Full-power deployment OR reduced-power deployment
Properly seated adult	Full-power deployment OR reduced-power deployment
Unoccupied seat	Reduced-power deployment

\* It is possible for a child to be classified as an adult, allowing a full-power front passenger air bag deployment. Never allow children to ride in the front passenger seat and never install a child restraint system, including a rearward-facing infant seat, in the front passenger seat.

### WARNING!

- Never place a rear facing infant seat in front of an air bag. A deploying Passenger Advanced Front Air Bag can cause death or serious injury to a child 12 years or younger, including a child in a rearward facing infant seat.
- Children 12 years or younger should always ride buckled up in a rear seat in an appropriate child restraint.

The OCM works with the OCS sensor to determine the front passenger seat occupant's most probable classification. The OCS sensor estimates the weight on the front passenger seat and where that weight is located. The OCM communicates the classification status to the ORC. The ORC uses the classification to determine whether the passenger Advanced Front Air Bag inflation rate should be modified.



In order for the OCS to operate as designed, it is important for the front passenger to be seated properly and properly wearing the seat belt. Properly seated passengers are:

- Sitting upright
- Facing forward
- Sitting in the center of the seat with their feet comfortably on or near the floor
- Sitting with their back against the seat back and the seat back in an upright position

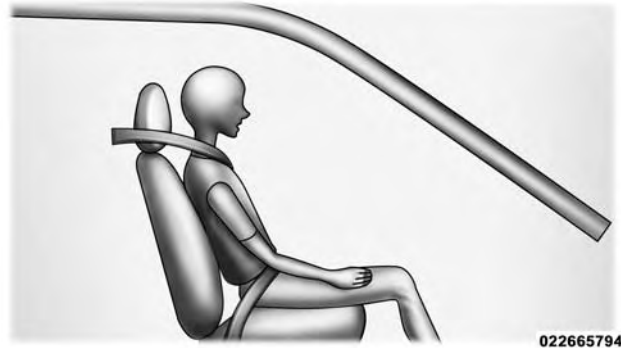

Seated Properly

**WARNING!**

Occupants in the front passenger seat sitting improperly may cause the OCS to not classify the passenger's weight accurately. This may result in serious injury or death in a collision. Always wear your seat belt and sit properly, with the seat back in an upright position, your back against the seat back, sitting upright, facing forward, in the center of the seat, with your feet comfortably on or near the floor. Do not carry or hold any objects (e.g., backpacks, boxes, etc.) while seated in the front passenger seat. Holding an object may cause the OCS to not classify the passenger's weight accurately, which may result in serious injury or death in a collision.

The OCS may not classify the front passenger properly if:

- The front passenger's weight is transferred to another part of the vehicle (like the door, arm rest or instrument panel)
- The front passenger leans forward, sideways or turns around
- The front passenger seatback is not in the full upright position
- The front passenger carries or holds an object while seated (e.g., backpack, box, etc.)

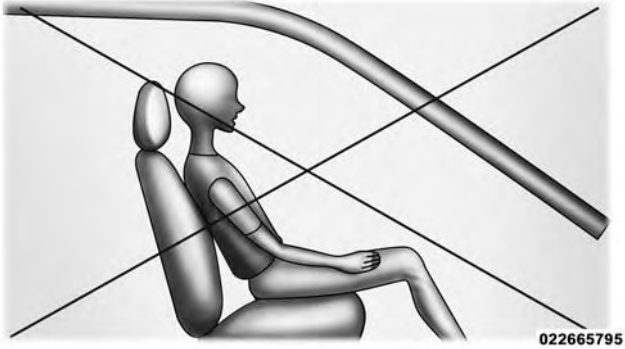

022665795

Not Seated Properly

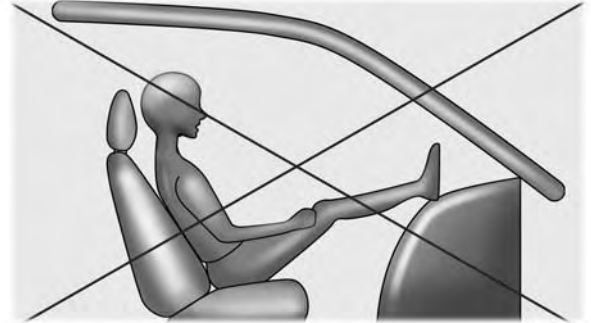

022665796

Not Seated Properly

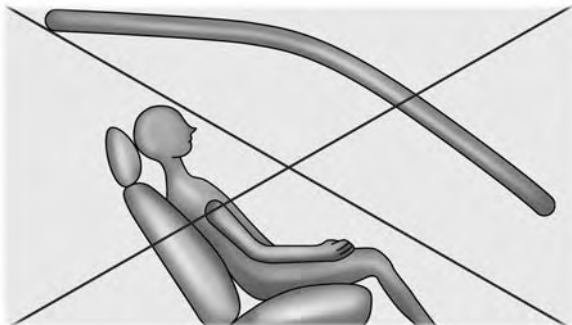

022665798

Not Seated Properly

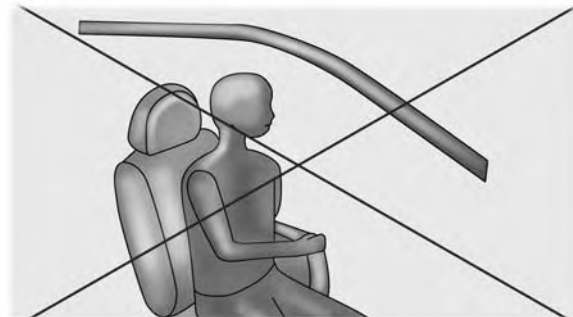

022665799

Not Seated Properly

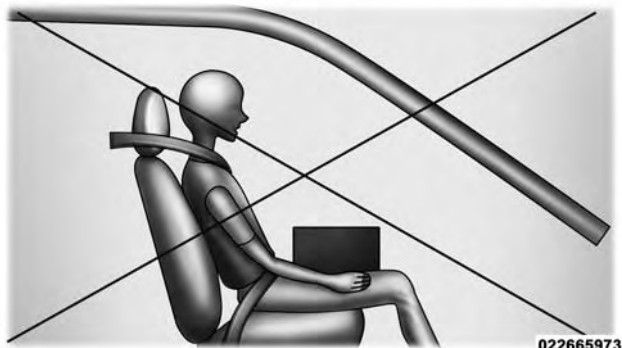

Not Seated Properly

## WARNING!

Placing an object on the floor under the front passenger seat may prevent the OCS from working properly, which may result in serious injury or death in a collision. Do not place any objects on the floor under the front passenger.

The Air Bag Warning Light  will turn on whenever the OCS is unable to classify the front passenger seat status. A malfunction in the OCS may affect the operation of the air bag system.

If the Air Bag Warning Light  does not come on, or stays on after you start the vehicle, or it comes on as you drive, take the vehicle to an authorized dealer for service immediately.

The front passenger seat is equipped with Flip 'n Stow™ Front Passenger Seat Storage (refer to “Understanding The Features Of Your Vehicle” for additional information). Make sure that objects inside the Flip 'n Stow™ Front Passenger Seat Storage bin do not interfere with the latch before closing the seat. In addition, after closing the Front Passenger Seat Storage bin make sure the front passenger seat cushion is pushed downward and fully latched to the base. Over-stuffing the storage bin may result in misclassification of the front passenger’s weight.

The passenger seat assembly contains critical components that may affect front passenger Advanced Air Bag inflation. In order for the OCS to properly classify a front seat passenger, the OCS components must function as designed. Do not make any modifications to the front passenger seat components, assembly, or to the seat cover. If the seat, trim cover, or cushion needs service for

any reason, take the vehicle to your authorized dealer. Only Chrysler Group LLC approved seat accessories may be used.

### **WARNING!**

**Make sure that objects inside the Flip 'n Stow™ Front Passenger Seat Storage bin do not interfere with the latch before closing the seat. In addition, after closing the Front Passenger Seat Storage bin, make sure the front passenger seat cushion is pushed downward and fully latched to the base. Overstuffing the storage bin, or a not fully latched passenger seat cushion, may result in misclassification of the front passenger’s weight. This may result in serious injury or death in a collision.**

The following requirements must be strictly followed:

- Do not modify the front passenger seat assembly or components in any way.
- Do not use prior or future model year seat covers or cushions not designated by Chrysler Group LLC for the specific model being repaired. Always use the correct seat cover and cushion specified for the vehicle.
- Do not replace the seat cover or cushion with an aftermarket seat cover or cushion.
- Do not add a secondary seat cover or mat.
- At no time should any supplemental restraint system (SRS) component or SRS related component or fastener be modified or replaced with any part except those which are approved by Chrysler Group LLC .

### **WARNING!**

**Unapproved modifications or service procedures to the passenger seat assembly, its related components, seat cover or cushion may inadvertently change the air bag deployment in case of a frontal collision. This could result in death or serious injury to the front passenger if the vehicle is involved in a collision. A modified vehicle may not comply with required Federal Motor Vehicle Safety Standards (FMVSS) and/or Canadian Motor Vehicle Safety Standards (CMVSS).**

### **Driver And Passenger Advanced Front Air Bag Inflator Units**

The Driver and Passenger Advanced Front Air Bag Inflator Units are located in the center of the steering wheel and on the right side of the instrument panel.

When the ORC detects a collision requiring the Advanced Front Air Bags, it signals the inflator units. A large quantity of non-toxic gas is generated to inflate the Advanced Front Air Bags. Different air bag inflation rates are possible, based on several factors, including the collision type and severity. The steering wheel hub trim cover and the upper right side of the instrument panel separate and fold out of the way as the air bags inflate to their full size. The air bags fully inflate in about 50 to 70 milliseconds. This is about half of the time it takes to blink your eyes. The air bags then quickly deflate while helping to restrain the driver and front passenger.

The Advanced Front Air Bag gas is vented through the vent holes of the air bag. In this way, the air bags do not interfere with your control of the vehicle.

### **Supplemental Driver Side Knee Air Bag Inflator Unit**

The Supplemental Knee Air Bag units are located in the instrument panel trim beneath the steering column and below the glove compartment. When the ORC detects a collision requiring the air bag, it signals the inflator units. A large quantity of non-toxic gas is generated to inflate the Supplemental Knee Air Bags. The Supplemental Knee Air Bag deploys down and around the knee blocker/glove box surface allowing the air bags to inflate to the full size. The air bags fully inflate in about 15 to 20 milliseconds.

### **Supplemental Seat-Mounted Side Air Bag (SAB) Inflator Units**

The Supplemental Seat-Mounted Side Air Bags (SAB) are designed to activate only in certain side collisions.

The ORC determines if a side collision requires the side air bags to inflate, based the severity and type of collision.



Based on the severity and type of collision, the side air bag inflators on the crash side of the vehicle may be triggered, releasing a quantity of non-toxic gas. The inflating SABs exit through the seat seam into the space between the occupant and the door. The SABs fully inflate in about 10 milliseconds. The side air bag moves at a very high speed and with such a high force that it could injure you if you are not seated properly, or if items are positioned in the area where the side air bag inflates. This especially applies to children.

### **Supplemental Side Air Bag Inflatable Curtain (SABIC) Inflator Units**

During collisions where the impact is confined to a particular area of the side of the vehicle, the ORC may deploy the SABIC air bags, depending on the severity and type of collision. In these events, the ORC will deploy the SABIC only on the impact side of the vehicle.

A quantity of non-toxic gas is generated to inflate the side curtain air bag. The inflating side curtain air bag pushes the outside edge of the headliner out of the way and covers the window. The air bag inflates in about 30 milliseconds (about one-quarter of the time that it takes to blink your eyes) with enough force to injure you if you are not belted and seated properly, or if items are positioned in the area where the side curtain air bag inflates. This especially applies to children. The side curtain air bag is only about 4 inches (10.16 cm) thick when it is inflated.

Because air bag sensors estimate deceleration over time, vehicle speed and damage are not good indicators of whether or not an air bag should have deployed.

### **Front And Side Impact Sensors**

In front and side impacts, impact sensors can aid the ORC in determining appropriate response to impact events.

## Enhanced Accident Response System

In the event of an impact causing air bag deployment, if the communication network remains intact, and the power remains intact, depending on the nature of the event the ORC will determine whether to have the Enhanced Accident Response System perform the following functions:

- Cut off fuel to the engine.
- Flash hazard lights as long as the battery has power or until the ignition key is turned off.
- Turn on the interior lights, which remain on as long as the battery has power, until the ignition key is removed.
- Unlock the doors automatically.

In order to reset the Enhanced Accident Response System functions after an event, the ignition switch must be changed from IGN ON to IGN OFF.

## If A Deployment Occurs

The Advanced Front Air Bags are designed to deflate immediately after deployment.

**NOTE:** Front and/or side air bags will not deploy in all collisions. This does not mean something is wrong with the air bag system.

If you do have a collision which deploys the air bags, any or all of the following may occur:

- The nylon air bag material may sometimes cause abrasions and/or skin reddening to the driver and front passenger as the air bags deploy and unfold. The abrasions are similar to friction rope burns or those you might get sliding along a carpet or gymnasium floor. They are not caused by contact with chemicals. They are not permanent and normally heal quickly. However, if you haven't healed significantly within a few days, or if you have any blistering, see your doctor immediately.

- As the air bags deflate, you may see some smoke-like particles. The particles are a normal by-product of the process that generates the non-toxic gas used for air bag inflation. These airborne particles may irritate the skin, eyes, nose, or throat. If you have skin or eye irritation, rinse the area with cool water. For nose or throat irritation, move to fresh air. If the irritation continues, see your doctor. If these particles settle on your clothing, follow the garment manufacturer's instructions for cleaning.

Do not drive your vehicle after the air bags have deployed. If you are involved in another collision, the air bags will not be in place to protect you.

**WARNING!**

**Deployed air bags and seat belt pretensioners cannot protect you in another collision. Have the air bags, seat belt pretensioners, and the front seat belt retractor assemblies replaced by an authorized dealer immediately. Also, have the Occupant Restraint Controller (ORC) system serviced as well.**

## Maintaining Your Air Bag System

**WARNING!**

- Modifications to any part of the air bag system could cause it to fail when you need it. You could be injured if the air bag system is not there to protect you. Do not modify the components or wiring, including adding any kind of badges or stickers to the steering wheel hub trim cover or the upper right side of the instrument panel. Do not modify the front bumper, vehicle body structure, or add aftermarket side steps or running boards.
- It is dangerous to try to repair any part of the air bag system yourself. Be sure to tell anyone who works on your vehicle that it has an air bag system.

*(Continued)*

**WARNING! (Continued)**

- Do not attempt to modify any part of your air bag system. The air bag may inflate accidentally or may not function properly if modifications are made. Take your vehicle to an authorized dealer for any air bag system service. If your seat, including your trim cover and cushion, needs to be serviced in any way (including removal or loosening/tightening of seat attachment bolts), take the vehicle to your authorized dealer. Only manufacturer approved seat accessories may be used. If it is necessary to modify the air bag system for persons with disabilities, contact your authorized dealer.

## Air Bag Warning Light



You will want to have the air bags ready to inflate for your protection in a collision. The Air Bag Warning Light monitors the internal circuits and interconnecting wiring associated with air bag system electrical components. While the air bag system is designed to be maintenance free, if any of the following occurs, have an authorized dealer service the air bag system immediately.

- The Air Bag Warning Light does not come on during the four to eight seconds when the ignition switch is first cycled to the ON/RUN position.
- The Air Bag Warning Light remains on after the four to eight-second interval.
- The Air Bag Warning Light comes on intermittently or remains on while driving.

**NOTE:** If the speedometer, tachometer, or any engine related gauges are not working, the Occupant Restraint Controller (ORC) may also be disabled. The air bags may not be ready to inflate for your protection. Promptly check the fuse block for blown fuses. Refer to the label located on the inside of the fuse block cover for the proper air bag fuses. See your authorized dealer if the fuse is good.

## Event Data Recorder (EDR)

This vehicle is equipped with an event data recorder (EDR). The main purpose of an EDR is to record, in certain crash or near crash-like situations, such as an air bag deployment or hitting a road obstacle, data that will assist in understanding how a vehicle's systems performed. The EDR is designed to record data related to

vehicle dynamics and safety systems for a short period of time, typically 30 seconds or less. The EDR in this vehicle is designed to record such data as:

- How various systems in your vehicle were operating;
- Whether or not the driver and passenger safety belts were buckled/fastened;
- How far (if at all) the driver was depressing the accelerator and/or brake pedal; and,
- How fast the vehicle was traveling.

These data can help provide a better understanding of the circumstances in which crashes and injuries occur.

**NOTE:** EDR data are recorded by your vehicle only if a non-trivial crash situation occurs; no data are recorded by the EDR under normal driving conditions and no personal data (e.g., name, gender, age, and crash location)

are recorded. However, other parties, such as law enforcement, could combine the EDR data with the type of personally identifying data routinely acquired during a crash investigation.

To read data recorded by an EDR, special equipment is required, and access to the vehicle or the EDR is needed. In addition to the vehicle manufacturer, other parties, such as law enforcement, that have the special equipment, can read the information if they have access to the vehicle or the EDR.

### **Child Restraints**

Everyone in your vehicle needs to be buckled up at all times, including babies and children. Every state in the United States, and every Canadian province, requires that small children ride in proper restraint systems. This is the law, and you can be prosecuted for ignoring it.

Children 12 years or younger should ride properly buckled up in a rear seat, if available. According to crash statistics, children are safer when properly restrained in the rear seats rather than in the front.

### **WARNING!**

**In a collision, an unrestrained child can become a projectile inside the vehicle. The force required to hold even an infant on your lap could become so great that you could not hold the child, no matter how strong you are. The child and others could be badly injured. Any child riding in your vehicle should be in a proper restraint for the child's size.**

There are different sizes and types of restraints for children from newborn size to the child almost large enough for an adult safety belt. Always check the child

seat Owner's Manual to make sure you have the correct seat for your child. Carefully read and follow all the instructions and warnings in the child restraint Owner's Manual and on all the labels attached to the car seat.

Before buying any restraint system, make sure that it has a label certifying that it meets all applicable Safety Standards. You should also make sure that you can install it in the vehicle where you will use it.

### **NOTE:**

- For additional information, refer to [www.seatcheck.org](http://www.seatcheck.org) or call 1-866-SEATCHECK. Canadian residents should refer to Transport Canada's website for additional information:
- <http://www.tc.gc.ca/eng/roadsafety/safedrivers-childsafety-index-53.htm>

### Summary Of Recommendations For Restraining Children In Vehicles

	<b>Child Size, Height, Weight or Age</b>	<b>Recommended Type of Child Restraint</b>
Infants and Toddlers	Children who are two years old or younger and who have not reached the height or weight limits of their child restraint	Either an Infant Carrier or a Convertible Child Restraint, facing rearward in the rear seat of the vehicle
Small Children	Children who are at least two years old or who have out-grown the height or weight limit of their rear-facing child restraint	Forward-Facing Child Restraint with a five-point Harness, facing forward in the rear seat of the vehicle
Larger Children	Children who have out-grown their forward-facing child restraint, but are too small to properly fit the vehicle's seat belt	Belt Positioning Booster Seat and the vehicle seat belt, seated in the rear seat of the vehicle
Children Too Large for Child Restraints	Children 12 years old or younger, who have out-grown the height or weight limit of their booster seat	Vehicle Seat Belt, seated in the rear seat of the vehicle



## Infants And Child Restraints

Safety experts recommend that children ride rearward-facing in the vehicle until they are two years old or until they reach either the height or weight limit of their rear facing child safety seat. Two types of child restraints can be used rearward-facing: infant carriers and convertible child seats.

The infant carrier is only used rearward-facing in the vehicle. It is recommended for children from birth until they reach the weight or height limit of the infant carrier. Convertible child seats can be used either rearward-facing or forward-facing in the vehicle. Convertible child seats often have a higher weight limit in the rearward-facing direction than infant carriers do, so they can be used rearward-facing by children who have outgrown their infant carrier but are still less than at least two years

old. Children should remain rearward-facing until they reach the highest weight or height allowed by their convertible child seat.

### WARNING!

- **Never place a rear facing infant seat in front of an air bag. A deploying Passenger Advanced Front Air Bag can cause death or serious injury to a child 12 years or younger, including a child in a rearward facing infant seat.**
- **Only use a rearward-facing child restraint in a vehicle with a rear seat.**

## Older Children And Child Restraints

Children who are two years old or who have outgrown their rear-facing convertible child seat can ride forward-facing in the vehicle. Forward-facing child seats and convertible child seats used in the forward-facing direction are for children who are over two years old or who have outgrown the rear-facing weight or height limit of their rear-facing convertible child seat. Children should remain in a forward-facing child seat with a harness for as long as possible, up to the highest weight or height allowed by the child seat.

All children whose weight or height is above the forward-facing limit for the child seat should use a belt-positioning booster seat until the vehicle's seat belts fit properly. If the child cannot sit with knees bent over the vehicle's seat cushion while the child's back is against the seatback, they should use a belt-positioning booster seat. The child and belt-positioning booster seat are held in the vehicle by the seat belt.

### **WARNING!**

- **Improper installation can lead to failure of an infant or child restraint. It could come loose in a collision. The child could be badly injured or killed. Follow the child restraint manufacturer's directions exactly when installing an infant or child restraint.**
- **Do not change the forward or rearward position of a vehicle seat where a child restraint is installed, as it can loosen the attachments of the car seat. Remove the child restraint before adjusting the vehicle seat position. When the vehicle seat has been adjusted, reinstall the child restraint.**
- **When your child restraint is not in use, secure it in the vehicle with the seat belt or LATCH anchorages, or remove it from the vehicle. Do not leave it loose in the vehicle. In a sudden stop or accident, it could strike the occupants or seatbacks and cause serious personal injury.**

## Children Too Large For Booster Seats

Children who are large enough to wear the shoulder belt comfortably, and whose legs are long enough to bend over the front of the seat when their back is against the seatback, should use the seat belt in a rear seat. Use this simple 5-step test to decide whether the child can use the vehicle's seat belt alone:

1. Can the child sit all the way back against the back of the vehicle seat?
2. Do the child's knees bend comfortably over the front of the vehicle seat – while they are still sitting all the way back?
3. Does the shoulder belt cross the child's shoulder between their neck and arm?
4. Is the lap part of the belt as low as possible, touching the child's thighs and not their stomach?
5. Can the child stay seated like this for the whole trip?

If the answer to any of these questions was “no,” then the child still needs to use a booster seat in this vehicle. If the child is using the lap/shoulder belt, check belt fit periodically and make sure the seat belt buckle is latched. A child's squirming or slouching can move the belt out of position. If the shoulder belt contacts the face or neck, move the child closer to the center of the vehicle, or use a booster seat to position the seat belt on the child correctly.

### WARNING!

**Never allow a child to put the shoulder belt under an arm or behind their back. In a crash, the shoulder belt will not protect a child properly, which may result in serious injury or death. A child must always wear both the lap and shoulder portions of the seat belt correctly.**

### Recommendations For Attaching Child Restraints

Restraint Type	Combined Weight of the Child + Child Restraint	Use any attachment method shown with an "X" Below			
		LATCH – Lower Anchors Only	Seat Belt Only	LATCH – Lower Anchors + Top Tether Anchor	Seat Belt + Top Tether Anchor
Rear-Facing Child Restraint	Up to 65 lbs (29.5 kg)	X	X		
Rear-Facing Child Restraint	More than 65 lbs (29.5 kg)		X		
Forward-Facing Child Restraint	Up to 65 lbs (29.5 kg)			X	X
Forward-Facing Child Restraint	More than 65 lbs (29.5 kg)		X		

## Lower Anchors and Tethers for Children (LATCH) Restraint System





022668173

Your vehicle is equipped with the child restraint anchorage system called LATCH, which stands for Lower Anchors and Tethers for CHildren. The LATCH system has three vehicle anchor points for installing LATCH-equipped child seats. There are two lower anchorages located at the back of the seat cushion where it meets the seatback and one top tether anchorage located behind the seating position. These anchorages are used to install LATCH-equipped child seats without using the vehicle's seat belts. Some seating positions may have a top tether anchorage but no lower anchorages. In these seating positions, the seat belt must be used with the top tether anchorage to install the child restraint. Please see the following table for more information.

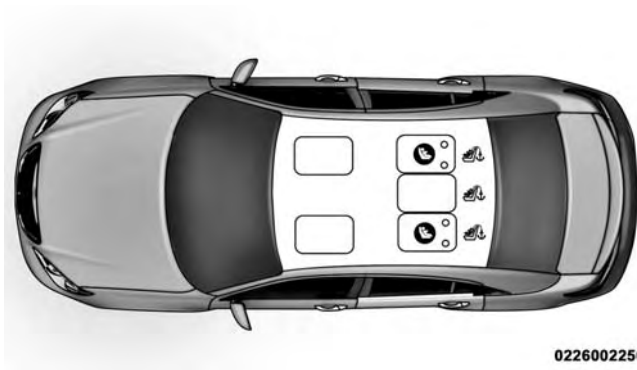
## LATCH Positions For Installing Child Restraints In This Vehicle



0226002256

-  Lower Anchorage Symbol 2 anchorages per seating position
-  Top Tether Anchorage Symbol

<p>What is the weight limit (child's weight + weight of the child restraint) for using the LATCH anchorage system to attach the child restraint?</p>	<p>65 lbs (29.5 kg)</p>	<p>Use the LATCH anchorage system until the combined weight of the child and the child restraint is 65 lbs (29.5 kg). Use the seat belt and tether anchor instead of the LATCH anchorage system once the combined weight is more than 65 lbs (29.5 kg).</p>
<p>Can the LATCH anchorages and the seat belt be used together to attach a rear-facing or forward-facing child restraint?</p>	<p>No</p>	<p>Do not use the seat belt when you use the LATCH anchorage system to attach a rear-facing or forward-facing child restraint.</p>
<p>Can a child seat be installed in the center position using the inner LATCH lower anchorages?</p>	<p>Yes</p>	<p>You can install child restraints with flexible lower anchors in the center position. The inner anchorages are 17 inches (440 mm) apart. Do not install child restraints with rigid lower anchors in the center position.</p>

Can two child restraints be attached using a common lower LATCH anchorage?	No	Never “share” a LATCH anchorage with two or more child restraints. If the center position does not have dedicated LATCH lower anchorages, use the seat belt to install a child seat in the center position next to a child seat using the LATCH anchorages in an outboard position.
Can the rear-facing child restraint touch the back of the front passenger seat?	Yes	The child seat may touch the back of the front passenger seat if the child restraint manufacturer also allows contact. See your child restraint owner’s manual for more information.
Can the head restraints be removed?	Yes	All head restraints may be removed.



## Locating The LATCH Anchorages



The lower anchorages are round bars that are found at the rear of the seat cushion where it meets the seatback, below the anchorage symbols on the seatback. They are just visible when you lean into the rear seat to install the child restraint. You will easily feel them if you run your finger along the gap between the seatback and seat cushion.

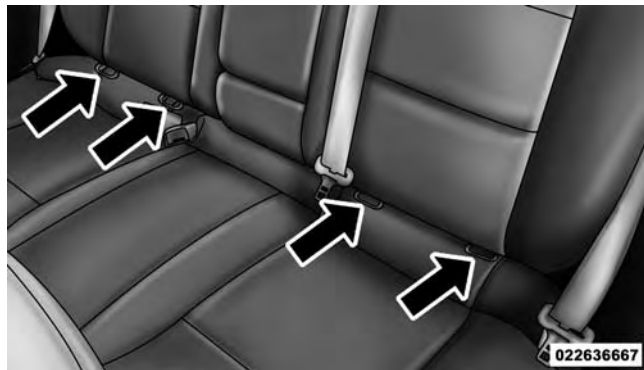

2

Rear Seat LATCH Anchorages

## Locating The LATCH Anchorages



In addition, there are tether strap anchorages behind each rear seating position located in the panel between the rear seatback and the rear window. They are found under a plastic cover with the tether anchorage symbol on it.

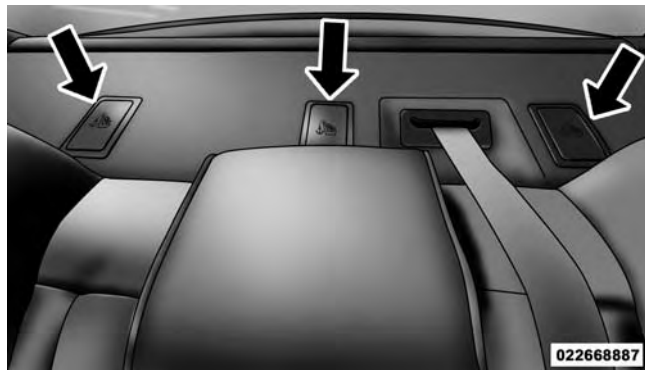

Tether Strap Anchorages

LATCH-compatible child restraint systems will be equipped with a rigid bar or a flexible strap on each side. Each will have a hook or connector to attach to the lower anchorage and a way to tighten the connection to the anchorage. Forward-facing child restraints and some rear-facing infant restraints will also be equipped with a tether strap. The tether strap will have a hook at the end to attach to the top tether anchorage and a way to tighten the strap after it is attached to the anchorage.

### Center Seat LATCH

Do not install child restraints with rigid lower attachments in the center seating position. Only install this type of child restraint in the outboard seating positions. Child restraints with flexible, webbing mounted lower attachments can be installed in any rear seating position.

**WARNING!**

Never use the same lower anchorage to attach more than one child restraint. If you are installing LATCH-compatible child restraints next to each other, you must use the seat belt for the center position. You can then use either the LATCH anchors or the vehicle's seat belt for installing child seats in the outboard positions. Please refer to "Installing The LATCH-Compatible Child Restraint System" for typical installation instructions.

Always follow the directions of the child restraint manufacturer when installing your child restraint. Not all child restraint systems will be installed as described here.

**To Install A LATCH-compatible Child Restraint**

1. If the selected seating position has a Switchable Automatic Locking Retractor (ALR) seat belt, stow the seat belt following the instructions below. See the section "Installing Child Restraints Using the Vehicle Seat Belt" to check what type of seat belt each seating position has.
2. Loosen the adjusters on the lower straps and on the tether strap of the child seat so that you can more easily attach the hooks or connectors to the vehicle anchorages.

3. Place the child seat between the lower anchorages for that seating position. For some second row seats, you may need to recline the seat and/or raise the head restraint to get a better fit. If the rear seat can be moved forward and rearward in the vehicle, you may wish to move it to its rear-most position to make room for the child seat. You may also move the front seat forward to allow more room for the car seat.
4. Attach the lower hooks or connectors of the child restraint to the lower anchorages in the selected seating position.
5. If the child restraint has a tether strap, connect it to the top tether anchorage. See the section "Installing Child Restraints Using the Top Tether Anchorage" for directions to attach a tether anchor.
6. Tighten all of the straps as you push the child restraint rearward and downward into the seat. Remove slack in the straps according to the child restraint manufacturer's instructions.
7. Test that the child restraint is installed tightly by pulling back and forth on the child seat at the belt path. It should not move more than 1 inch (25.4 mm) in any direction.

## How To Stow An Unused ALR Seatbelt

When using the LATCH attaching system to install a child restraint, stow all ALR seat belts that are not being used by other occupants or being used to secure child restraints. An unused belt could injure a child if they play with it and accidentally lock the seatbelt retractor. Before installing a child restraint using the LATCH system, buckle the seat belt behind the child restraint and out of the child's reach. If the buckled seat belt interferes with the child restraint installation, instead of buckling it behind the child restraint, route the seat belt through the child restraint belt path and then buckle it. Do not lock the seatbelt. Remind all children in the vehicle that the seat belts are not toys and that they should not play with them.

### WARNING!

- **Improper installation of a child restraint to the LATCH anchorages can lead to failure of an infant or child restraint. The child could be badly injured or killed. Follow the manufacturer's directions exactly when installing an infant or child restraint.**
- **Child restraint anchorages are designed to withstand only those loads imposed by correctly-fitted child restraints. Under no circumstances are they to be used for adult seat belts, harnesses, or for attaching other items or equipment to the vehicle.**

## Installing Child Restraints Using The Vehicle Seat Belt

The seat belts in the passenger seating positions are equipped with either a Switchable Automatic Locking Retractor (ALR) or a cinching latch plate or both. Both types of seat belts are designed to keep the lap portion of

the seat belt tight around the child restraint so that it is not necessary to use a locking clip. The ALR retractor can be “switched” into a locked mode by pulling all of the webbing out of the retractor and then letting the webbing retract back into the retractor. If it is locked, the ALR will make a clicking noise while the webbing is pulled back into the retractor. For additional information on ALR, refer to the “Automatic Locking Mode” description under “Occupant Restraints”. The cinching latch plate is designed to hold the lap portion of the seatbelt tight when webbing is pulled tight and straight through a child restraint’s belt path. Please see the following table(s) and the following sections for more information about both types of seat belts.

### Lap/Shoulder Belt Systems for Installing Child Restraints in this Vehicle

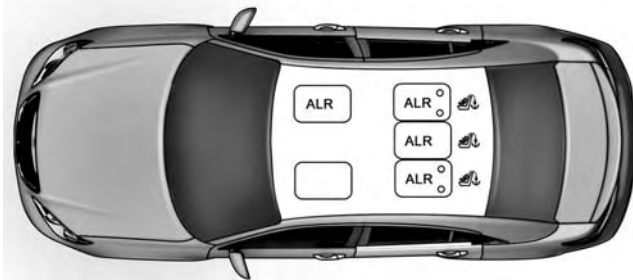

022669039

<p>What is the weight limit (child's weight + weight of the child restraint) for using the Tether Anchor with the seat belt to attach a forward facing child restraint?</p>	<p>Weight limit of the Child Restraint</p>	<p>Always use the tether anchor when using the seat belt to install a forward facing child restraint, up to the recommended weight limit of the child restraint.</p>
<p>Can the rear-facing child restraint touch the back of the front passenger seat?</p>	<p>Yes</p>	<p>Contact between the front passenger seat and the child restraint is allowed, if the child restraint manufacturer also allows contact.</p>
<p>Can the head restraints be removed?</p>	<p>Yes</p>	<p>All head restraints may be removed.</p>
<p>Can the buckle stalk be twisted to tighten the seat belt against the belt path of the child restraint?</p>	<p>Yes</p>	<p>In positions with cinching latch plates (CINCH), the buckle stalk may be twisted up to 3 full turns. Do not twist the buckle stalk in a seating position with an ALR retractor.</p>

### Installing A Child Restraint With A Switchable Automatic Locking Retractor (ALR)

1. Place the child seat in the center of the seating position. For some second row seats, you may need to recline the seat and/or raise the head restraint to get a better fit. If the rear seat can be moved forward and rearward in the vehicle, you may wish to move it to its rear-most position to make room for the child seat. You may also move the front seat forward to allow more room for the car seat.
2. Pull enough of the seat belt webbing from the retractor to pass it through the belt path of the child restraint. Do not twist the belt webbing in the belt path.
3. Slide the latch plate into the buckle until you hear a "click".
4. Pull on the webbing to make the lap portion tight against the child seat.
5. To lock the seat belt, pull down on the shoulder part of the belt until you have pulled all the seat belt webbing out of the retractor. Then, allow the webbing to retract back into the retractor. As the webbing retracts, you will hear a clicking sound. This means the seat belt is now in the Automatic Locking mode.
6. Try to pull the webbing out of the retractor. If it is locked, you should not be able to pull out any webbing. If the retractor is not locked, repeat step 5.
7. Finally, pull up on any excess webbing to tighten the lap portion around the child restraint while you push the child restraint rearward and downward into the vehicle seat.
8. If the child restraint has a top tether strap and the seating position has a top tether anchorage, connect the tether strap to the anchorage and tighten the tether



strap. See the section “Installing Child Restraints Using the Top Tether Anchorage” for directions to attach a tether anchor.

9. Test that the child restraint is installed tightly by pulling back and forth on the child seat at the belt path. It should not move more than 1 inch (25.4 mm) in any direction.

Any seat belt system will loosen with time, so check the belt occasionally, and pull it tight if necessary.

### **Installing A Child Restraint With A Cinching Latch Plate (CINCH) — If Equipped**

1. Place the child seat in the center of the seating position. For some second row seats, you may need to recline the seat and/or raise the head restraint to get a better fit. If the rear seat can be moved forward and rearward in the vehicle, you may wish to move it to its

rear-most position to make room for the child seat. You may also move the front seat forward to allow more room for the car seat.

2. Next, pull enough of the seat belt webbing from the retractor to pass it through the belt path of the child restraint. Do not twist the belt webbing in the belt path.
3. Slide the latch plate into the buckle until you hear a “click”.
4. Finally, pull up on any excess webbing to tighten the lap portion around the child restraint while you push the child restraint rearward and downward into the vehicle seat.
5. If the child restraint has a top tether strap and the seating position has a top tether anchorage, connect the tether strap to the anchorage and tighten the tether

strap. Refer to “Installing Child Restraints Using The Top Tether Anchorage” for directions to attach a tether anchor.

6. Test that the child restraint is installed tightly by pulling back and forth on the child seat at the belt path. It should not move more than 1 inch (25 mm) in any direction.

Any seat belt system will loosen with time, so check the belt occasionally, and pull it tight if necessary.

If the buckle or the cinching latch plate is too close to the belt path opening of the child restraint, you may have trouble tightening the seat belt. If this happens, disconnect the latch plate from the buckle and twist the short buckle-end belt up to three full turns to shorten it. Insert the latch plate into the buckle with the release button facing out, away from the child restraint. Repeat steps 4 to 6, above, to complete the installation of the child restraint.

If the belt still cannot be tightened after you shorten the buckle, disconnect the latch plate from the buckle, turn the buckle around one half turn, and insert the latch plate into the buckle again. If you still cannot make the child restraint installation tight, try a different seating position.

### Installing Child Restraints Using The Top Tether Anchorage



1. Look behind the seating position where you plan to install the child restraint to find the tether anchorage. You may need to move the seat forward to provide better access to the tether anchorage. If there is no top tether anchorage for that seating position, move the child restraint to another position in the vehicle if one is available.

2. Rotate or lift the cover to access the anchor directly behind the seat where you are placing the child restraint.
3. Route the tether strap to provide the most direct path for the strap between the anchor and the child seat. If your vehicle is equipped with adjustable rear head restraints, raise the head restraint, and where possible, route the tether strap under the head restraint and between the two posts. If not possible, lower the head restraint and pass the tether strap around the outboard side of the head restraint.

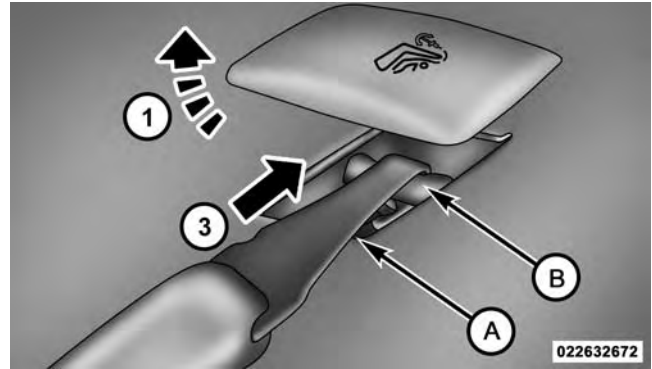

Tether Strap Mounting

1 — Cover	A — Tether Strap Hook
3 — Attaching Strap	B — Tether Anchor

4. Attach the tether strap hook of the child restraint to the top tether anchorage as shown in the diagram.

5. Remove slack in the tether strap according to the child restraint manufacturer's instructions.

**WARNING!**

- An incorrectly anchored tether strap could lead to increased head motion and possible injury to the child. Use only the anchorage position directly behind the child seat to secure a child restraint top tether strap.
- If your vehicle is equipped with a split rear seat, make sure the tether strap does not slip into the opening between the seatbacks as you remove slack in the strap.

**Transporting Pets**

Air Bags deploying in the front seat could harm your pet. An unrestrained pet will be thrown about and possibly injured, or injure a passenger during panic braking or in a collision.

Pets should be restrained in the rear seat in pet harnesses or pet carriers that are secured by seat belts.

**ENGINE BREAK-IN RECOMMENDATIONS**

A long break-in period is not required for the engine and drivetrain (transmission and axle) in your vehicle.

Drive moderately during the first 300 miles (500 km). After the initial 60 miles (100 km), speeds up to 50 or 55 mph (80 or 90 km/h) are desirable.

While cruising, brief full-throttle acceleration within the limits of local traffic laws contributes to a good break-in. Wide-open throttle acceleration in low gear can be detrimental and should be avoided.

The engine oil installed in the engine at the factory is a high-quality energy conserving type lubricant. Oil changes should be consistent with anticipated climate conditions under which vehicle operations will occur. For the recommended viscosity and quality grades, refer to "Maintenance Procedures" in "Maintaining Your Vehicle".

**CAUTION!**

Never use Non-Detergent Oil or Straight Mineral Oil in the engine or damage may result.

**NOTE:** A new engine may consume some oil during its first few thousand miles (kilometers) of operation. This should be considered a normal part of the break-in and not interpreted as an indication of difficulty.

**SAFETY TIPS****Transporting Passengers**

NEVER TRANSPORT PASSENGERS IN THE CARGO AREA.

**WARNING!**

- Do not leave children or animals inside parked vehicles in hot weather. Interior heat build-up may cause serious injury or death.

*(Continued)*

**WARNING! (Continued)**

- It is extremely dangerous to ride in a cargo area, inside or outside of a vehicle. In a collision, people riding in these areas are more likely to be seriously injured or killed.
- Do not allow people to ride in any area of your vehicle that is not equipped with seats and seat belts.
- Be sure everyone in your vehicle is in a seat and using a seat belt properly.

**Exhaust Gas****WARNING!**

Exhaust gases can injure or kill. They contain carbon monoxide (CO), which is colorless and odorless. Breathing it can make you unconscious and can

*(Continued)*

**WARNING! (Continued)**

eventually poison you. To avoid breathing (CO), follow these safety tips:

- Do not run the engine in a closed garage or in confined areas any longer than needed to move your vehicle in or out of the area.
- If you are required to drive with the trunk/liftgate/rear doors open, make sure that all windows are closed and the climate control BLOWER switch is set at high speed. DO NOT use the recirculation mode.
- If it is necessary to sit in a parked vehicle with the engine running, adjust your heating or cooling controls to force outside air into the vehicle. Set the blower at high speed.

The best protection against carbon monoxide entry into the vehicle body is a properly maintained engine exhaust system.

Whenever a change is noticed in the sound of the exhaust system, when exhaust fumes can be detected inside the vehicle, or when the underside or rear of the vehicle is damaged, have a competent mechanic inspect the complete exhaust system and adjacent body areas for broken, damaged, deteriorated, or mispositioned parts. Open seams or loose connections could permit exhaust fumes to seep into the passenger compartment. In addition, inspect the exhaust system each time the vehicle is raised for lubrication or oil change. Replace as required.

## **Safety Checks You Should Make Inside The Vehicle**

### **Seat Belts**

Inspect the belt system periodically, checking for cuts, frays, and loose parts. Damaged parts must be replaced immediately. Do not disassemble or modify the system.

Front seat belt assemblies must be replaced after a collision. Rear seat belt assemblies must be replaced after a collision if they have been damaged (i.e., bent retractor, torn webbing, etc.). If there is any question regarding belt or retractor condition, replace the belt.

### **Air Bag Warning Light**



The light should come on and remain on for four to eight seconds as a bulb check when the ignition switch is first turned ON. If the light is not lit during starting, see your authorized dealer. If the light stays on, flickers, or comes on while driving, have the system checked by an authorized dealer.

### **Defroster**

Check operation by selecting the defrost mode and place the blower control on high speed. You should be able to feel the air directed against the windshield. See your authorized dealer for service if your defroster is inoperable.

### Floor Mat Safety Information

Always use floor mats designed to fit the footwell of your vehicle. Use only floor mats that leave the pedal area unobstructed and that are firmly secured so that they cannot slip out of position and interfere with the pedals or impair safe operation of your vehicle in other ways.

#### **WARNING!**

Pedals that cannot move freely can cause loss of vehicle control and increase the risk of serious personal injury.

- Always make sure that floor mats are properly attached to the floor mat fasteners.

*(Continued)*

#### **WARNING! (Continued)**

- Never place or install floor mats or other floor coverings in the vehicle that cannot be properly secured to prevent them from moving and interfering with the pedals or the ability to control the vehicle.
- Never put floor mats or other floor coverings on top of already installed floor mats. Additional floor mats and other coverings will reduce the size of the pedal area and interfere with the pedals.
- Check mounting of mats on a regular basis. Always properly reinstall and secure floor mats that have been removed for cleaning.

*(Continued)*



**WARNING! (Continued)**

- Always make sure that objects cannot fall into the driver footwell while the vehicle is moving. Objects can become trapped under the brake pedal and accelerator pedal causing a loss of vehicle control.
- If required, mounting posts must be properly installed, if not equipped from the factory.

Failure to properly follow floor mat installation or mounting can cause interference with the brake pedal and accelerator pedal operation causing loss of control of the vehicle.

**Periodic Safety Checks You Should Make Outside The Vehicle****Tires**

Examine tires for excessive tread wear and uneven wear patterns. Check for stones, nails, glass, or other objects

lodged in the tread or sidewall. Inspect the tread for cuts and cracks. Inspect sidewalls for cuts, cracks and bulges. Check the wheel nuts for tightness. Check the tires (including spare) for proper cold inflation pressure.

**Lights**

Have someone observe the operation of brake lights and exterior lights while you work the controls. Check turn signal and high beam indicator lights on the instrument panel.

**Door Latches**

Check for positive closing, latching, and locking.

**Fluid Leaks**

Check area under vehicle after overnight parking for fuel, engine coolant, oil, or other fluid leaks. Also, if gasoline fumes are detected or if fuel, power steering fluid (if equipped), or brake fluid leaks are suspected, the cause should be located and corrected immediately.



# UNDERSTANDING THE FEATURES OF YOUR VEHICLE

## CONTENTS

■ MIRRORS . . . . .	.119	□ Illuminated Vanity Mirrors — If Equipped . . .	.123
□ Inside Day/Night Mirror . . . . .	.119	■ BLIND SPOT MONITORING (BSM) — IF EQUIPPED . . . . .	.124
□ Automatic Dimming Mirror — If Equipped . . . . .	.119	□ Rear Cross Path . . . . .	.130
□ Outside Mirrors . . . . .	.120	□ Modes Of Operation . . . . .	.131
□ Outside Mirrors Folding Feature — If Equipped . . . . .	.121	■ Uconnect® Phone (Uconnect® 200) . . . . .	.133
□ Outside Mirrors With Turn Signal And Approach Lighting — If Equipped . . . . .	.121	□ Operation . . . . .	.135
□ Power Mirrors . . . . .	.122	□ Phone Call Features . . . . .	.142
□ Heated Mirrors — If Equipped . . . . .	.122	□ Uconnect® Phone Features . . . . .	.145
		□ Advanced Phone Connectivity . . . . .	.150

## 114 UNDERSTANDING THE FEATURES OF YOUR VEHICLE

- Things You Should Know About Your Uconnect® Phone. . . . .152
- General Information . . . . .163
- Uconnect® Phone (8.4/8.4N) . . . . .163
  - Uconnect® 8.4/8.4Nav . . . . .163
  - Operation . . . . .166
  - Phone Call Features . . . . .178
  - Uconnect® Phone Features . . . . .182
  - Advanced Phone Connectivity . . . . .187
  - Things You Should Know About Your Uconnect® Phone. . . . .188
  - General Information . . . . .199
- VOICE COMMAND (Uconnect® 200) . . . . .199
  - Voice Command System Operation . . . . .199
  - Commands . . . . .201
  - Voice Training . . . . .205
- VOICE COMMAND . . . . .206
  - Uconnect® 8.4/8.4 Nav . . . . .206
  - Uconnect® Voice Commands . . . . .209
- SEATS . . . . .219
  - Power Seats — If Equipped . . . . .220
  - Manual Front Seat Forward/Rearward Adjustment . . . . .222
  - Manual Front Seat Recline Adjustment . . . . .223
  - Manual Seat Height Adjustment — If Equipped . . . . .224
  - Heated Seats — If Equipped . . . . .224
  - Head Restraints . . . . .227

<ul style="list-style-type: none"> <li>□ Folding Rear Seat . . . . .229</li> </ul>	<b>UNDERSTANDING THE FEATURES OF YOUR VEHICLE 115</b>
<ul style="list-style-type: none"> <li>■ TO OPEN AND CLOSE THE HOOD . . . . .231</li> </ul>	<ul style="list-style-type: none"> <li>□ Turn Signals . . . . .239</li> </ul>
<ul style="list-style-type: none"> <li>■ LIGHTS . . . . .234</li> </ul>	<ul style="list-style-type: none"> <li>□ Lane Change Assist . . . . .239</li> </ul>
<ul style="list-style-type: none"> <li>□ Headlight Switch . . . . .234</li> </ul>	<ul style="list-style-type: none"> <li>□ High/Low Beam Switch . . . . .240</li> </ul>
<ul style="list-style-type: none"> <li>□ Automatic Headlights — If Equipped . . . . .235</li> </ul>	<ul style="list-style-type: none"> <li>□ Flash-To-Pass . . . . .240</li> </ul>
<ul style="list-style-type: none"> <li>□ Headlights On With Wipers (Available With Automatic Headlights Only) . . . . .235</li> </ul>	<ul style="list-style-type: none"> <li>□ Front Map/Reading Lights . . . . .240</li> </ul>
<ul style="list-style-type: none"> <li>□ Headlight Time Delay . . . . .235</li> </ul>	<ul style="list-style-type: none"> <li>□ Interior Lights . . . . .241</li> </ul>
<ul style="list-style-type: none"> <li>□ Automatic High Beam Headlamp Control — If Equipped . . . . .236</li> </ul>	<ul style="list-style-type: none"> <li>■ WINDSHIELD WIPERS AND WASHERS . . . . .243</li> </ul>
<ul style="list-style-type: none"> <li>□ Daytime Running Lights (DRL) . . . . .237</li> </ul>	<ul style="list-style-type: none"> <li>□ Intermittent Wiper System . . . . .244</li> </ul>
<ul style="list-style-type: none"> <li>□ Lights-On Reminder . . . . .237</li> </ul>	<ul style="list-style-type: none"> <li>□ Wiper Operation . . . . .244</li> </ul>
<ul style="list-style-type: none"> <li>□ Fog Lights — If Equipped . . . . .238</li> </ul>	<ul style="list-style-type: none"> <li>□ Mist Feature . . . . .245</li> </ul>
<ul style="list-style-type: none"> <li>□ Multifunction Lever . . . . .238</li> </ul>	<ul style="list-style-type: none"> <li>□ Windshield Washers . . . . .245</li> </ul>
	<ul style="list-style-type: none"> <li>□ Headlights On With Wipers (Available With Automatic Headlights Only) . . . . .245</li> </ul>

- Rain Sensing Wipers — If Equipped . . . . . 246
- TILT/TELESCOPING STEERING COLUMN . . . 248
- HEATED STEERING WHEEL —  
IF EQUIPPED . . . . . 249
- ELECTRONIC SPEED CONTROL — IF EQUIPPED  
. . . . . 251
  - To Activate . . . . . 252
  - To Set A Desired Speed . . . . . 252
  - To Deactivate . . . . . 253
  - To Resume Speed . . . . . 253
  - To Vary The Speed Setting . . . . . 253
  - To Accelerate For Passing . . . . . 255
- PARKSENSE® REAR PARK ASSIST — IF  
EQUIPPED . . . . . 255
  - ParkSense® Sensors . . . . . 256
  - ParkSense® Warning Display . . . . . 256
  - ParkSense® Display . . . . . 256
  - Enabling And Disabling ParkSense® . . . . . 264
  - Service The ParkSense® Rear Park Assist  
System . . . . . 264
  - Cleaning The ParkSense® System . . . . . 267
  - ParkSense® System Usage Precautions. . . . . 267
- PARKVIEW® REAR BACK UP CAMERA — IF  
EQUIPPED . . . . . 269
  - Turning ParkView® On Or Off — With  
Touchscreen Radio. . . . . 271

<ul style="list-style-type: none"> <li>■ OVERHEAD CONSOLE . . . . .271                     <ul style="list-style-type: none"> <li>□ Front Map/Reading Lights . . . . .272</li> <li>□ Sunglass Bin Door . . . . .272</li> </ul> </li> <li>■ GARAGE DOOR OPENER — IF EQUIPPED . . .273                     <ul style="list-style-type: none"> <li>□ Before You Begin Programming HomeLink® . .274</li> <li>□ Programming A Rolling Code . . . . .275</li> <li>□ Programming A Non-Rolling Code . . . . .277</li> <li>□ Canadian/Gate Operator Programming . . . . .278</li> <li>□ Using HomeLink® . . . . .280</li> <li>□ Security . . . . .280</li> <li>□ Troubleshooting Tips . . . . .280</li> <li>□ General Information. . . . .282</li> </ul> </li> </ul>	<ul style="list-style-type: none"> <li>■ POWER SUNROOF — IF EQUIPPED . . . . .282                     <ul style="list-style-type: none"> <li>□ Opening Sunroof — Express . . . . .283</li> <li>□ Opening Sunroof — Manual Mode . . . . .284</li> <li>□ Closing Sunroof — Express. . . . .284</li> <li>□ Closing Sunroof — Manual Mode . . . . .284</li> <li>□ Pinch Protect Feature . . . . .284</li> <li>□ Pinch Protect Override. . . . .285</li> <li>□ Venting Sunroof — Express . . . . .285</li> <li>□ Sunshade Operation. . . . .285</li> <li>□ Wind Buffeting . . . . .285</li> <li>□ Sunroof Maintenance . . . . .285</li> </ul> </li> <li>■ ELECTRICAL POWER OUTLETS — IF EQUIPPED . . . . .286</li> </ul>
--	---

■ CUPHOLDERS . . . . .	.290	□ Rear Seat Armrest Storage — If Equipped . . . . .	.295
□ Front Seat Cupholders . . . . .	.290	■ CARGO AREA FEATURES . . . . .	.295
□ Rear Seat Cupholders . . . . .	.290	□ Cargo Area — 60/40 Split-Folding Rear Seat — If Equipped . . . . .	.295
■ STORAGE . . . . .	.291	□ Cargo Tie-Downs. . . . .	.298
□ Glove Compartment . . . . .	.291	□ Ski Pass-Through. . . . .	.298
□ Console Features . . . . .	.291	■ REAR WINDOW FEATURES . . . . .	.299
□ Door Storage. . . . .	.293	□ Rear Window Defroster . . . . .	.299
□ Passenger Seat Storage — If Equipped. . . . .	.294		



## MIRRORS

### Inside Day/Night Mirror

A single ball joint mirror is provided in the vehicle. It is a twist on mirror that has a fixed position at the windshield. The mirror installs on the windshield button with a counterclockwise rotation and requires no tools for mounting. The mirror head can be adjusted up, down, left, and right for various drivers. The mirror should be adjusted to center on the view through the rear window.

Headlight glare from vehicles behind you can be reduced by moving the small control under the mirror to the night position (toward the rear of the vehicle). The mirror should be adjusted while the small control under the mirror is set in the day position (toward the windshield).



3

030407085

#### Adjusting Rearview Mirror

#### Automatic Dimming Mirror — If Equipped

This mirror automatically adjusts for headlight glare from vehicles behind you. This feature will be defaulted on, and only be disabled when the vehicle is moving in reverse. The automatic dimming mirror turns on and off by manually pressing the button at the base of the mirror.

**NOTE:** This feature is disabled when the vehicle is moving in reverse.



030436523

Automatic Dimming Mirror

**CAUTION!**

To avoid damage to the mirror during cleaning, never spray any cleaning solution directly onto the mirror. Apply the solution onto a clean cloth and wipe the mirror clean.

**Outside Mirrors**

To receive maximum benefit, adjust the outside mirror(s) to center on the adjacent lane of traffic and a slight overlap of the view obtained from the inside mirror.

**NOTE:** The passenger side convex outside mirror will give a much wider view to the rear, and especially of the lane next to your vehicle.

**WARNING!**

Vehicles and other objects seen in the passenger side convex mirror will look smaller and farther away than they really are. Relying too much on your passenger side convex mirror could cause you to collide with another vehicle or other object. Use your inside mirror when judging the size or distance of a vehicle seen in the passenger side convex mirror.

**Outside Mirrors Folding Feature — If Equipped**

Some models have outside mirrors that are hinged. The hinge allows the mirror to pivot forward and rearward to resist damage. The hinge has three detent positions: full forward, full rearward and normal.

**Outside Mirrors With Turn Signal And Approach Lighting — If Equipped**

Driver and passenger outside mirrors with turn signal and puddle lamp contain three LEDs.

Two of the LED's are used as turn signal indicators, which flash with the corresponding turn signal lights in the front and rear of the vehicle. Turning on the Hazard Warning flashers will also activate these LEDs.

The third LED supplies illuminated entry lighting, which turns on in both mirrors when you use the Remote Keyless Entry (RKE) transmitter or open any door. This LED shines downward to illuminate the ground adjacent to the Front and Rear Doors.

The Illuminated Entry lighting fades to off after about 30 seconds or it will fade to off immediately once the ignition is placed into the RUN position.

**NOTE:** The approach lighting will not function when the shift lever is moved out of the PARK position.

### Power Mirrors

The power mirror controls are located on the drivers door trim panel.



Power Mirror Control

The power mirror controls consist of mirror select buttons and a four-way mirror control switch. To adjust a mirror, press either the L (left) or R (right) button to select the mirror that you want to adjust.

Using the mirror control switch, press on any of the four arrows for the direction that you want the mirror to move.

### Heated Mirrors — If Equipped

 These mirrors are heated to melt frost or ice. This feature can be activated whenever you turn on the rear window defroster (if equipped). Refer to “Rear Window Features” in “Understanding The Features Of Your Vehicle” for further information.

### Illuminated Vanity Mirrors — If Equipped

An illuminated vanity mirror is on each sun visor. To use the mirror, rotate the sun visor downward and swing the mirror cover upward. The light will turn on automatically. Closing the mirror cover will turn off the light.



Illuminated Vanity Mirror

### Sun Visor “Slide-On Rod” Feature — If Equipped

This feature allows for additional flexibility in positioning the visor to block out the sun.

1. Fold down the sun visor.
2. Unclip the visor from the center clip.
3. Pull the sun visor toward the inside rearview mirror to extend it.

**BLIND SPOT MONITORING (BSM) — IF EQUIPPED**

The Blind Spot Monitoring (BSM) system uses two radar-based sensors, located inside the rear bumper fascia, to detect highway licensable vehicles (automobiles, trucks, motorcycles, etc.) that enter the blind spot zones from the rear/front/side of the vehicle.

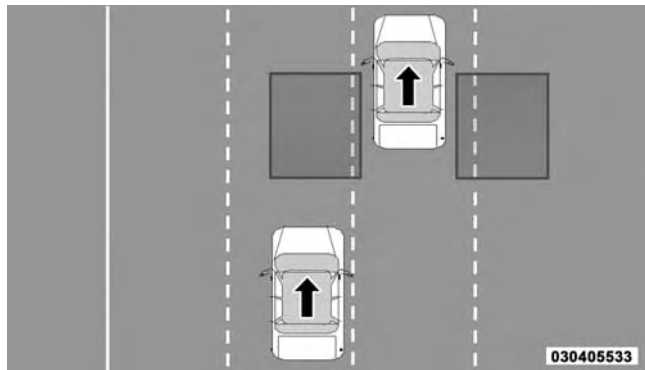

Rear Detection Zones

When the vehicle is started, the BSM warning light will momentarily illuminate in both outside rear view mirrors to let the driver know that the system is operational.

**Automatic Transmission Vehicles**

The BSM system sensors operate when the vehicle is in any forward gear or REVERSE and enters stand-by mode when the vehicle is in PARK.

**Manual Transmission Vehicles**

The BSM system sensors operate when the vehicle is in any gear and enters stand-by mode when the Park Brake is engaged, the vehicle is not in REVERSE, and the vehicle is stationary.

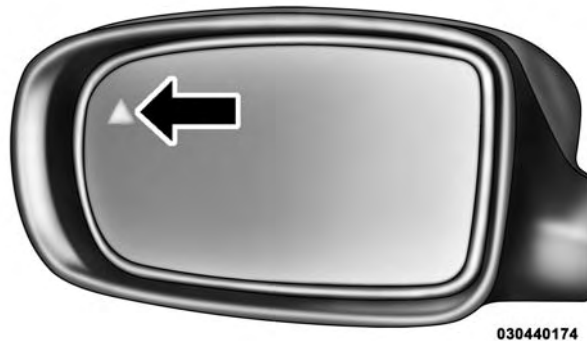

### BSM Warning Light

The BSM detection zone covers approximately one lane on both sides of the vehicle (12 ft or 3.8 m). The zone starts at the outside rear view mirror and extends approximately 23 ft (7 m) to the rear of the vehicle. The BSM system monitors the detection zones on both sides of the

vehicle when the vehicle speed reaches approximately 6 mph (10 km/h) or higher and will alert the driver of vehicles in these areas.

### NOTE:

- The BSM system does NOT alert the driver about rapidly approaching vehicles that are outside the detection zones.
- The BSM system detection zone DOES NOT change if your vehicle is towing a trailer. Therefore, visually verify the adjacent lane is clear for both your vehicle and trailer before making a lane change. If the trailer or other object (i.e., bicycle, sports equipment) extends beyond the side of your vehicle, this may result in the BSM warning light remaining illuminated the entire time the vehicle is in a forward gear.

The area on the rear fascia where the radar sensors are located must remain free of snow, ice, and dirt/road

contamination so that the BSM system can function properly. Do not block the area of the rear fascia where the radar sensors are located with foreign objects (bumper stickers, bicycle racks, etc.).

The BSM system notifies the driver of objects in the detection zones by illuminating the BSM warning light located in the outside mirrors in addition to sounding an audible (chime) alert and reducing the radio volume. Refer to “Modes Of Operation” for further information.

The BSM system monitors the detection zone from three different entry points (side, rear, front) while driving to see if an alert is necessary. The BSM system will issue an alert during these types of zone entries.

### Entering From The Side

Vehicles that move into your adjacent lanes from either side of the vehicle.

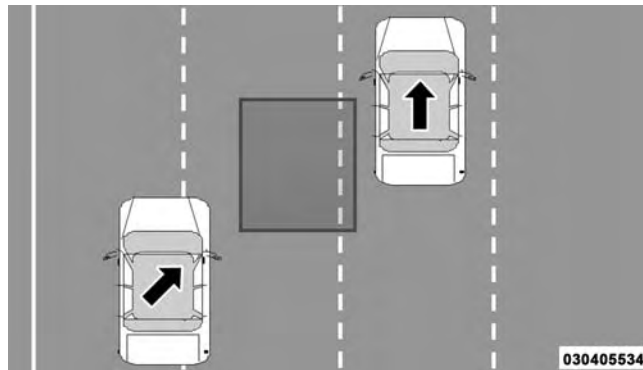

### Side Monitoring

#### Entering From The Rear

Vehicles that come up from behind your vehicle on either side and enter the rear detection zone with a relative speed of less than 30 mph (48 km/h).



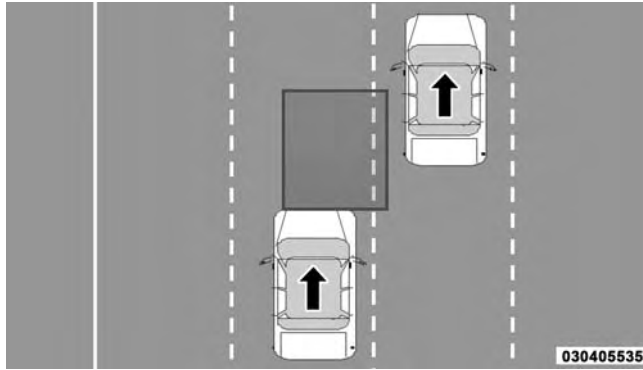

Rear Monitoring

### Overtaking Traffic

If you pass another vehicle slowly (with a relative speed of less than 15 mph (24 km/h) and the vehicle remains in the blind spot for approximately 1.5 seconds, the warning light will be illuminated. If the difference in speed

between the two vehicles is greater than 15 mph (24 km/h), the warning light will not illuminate.

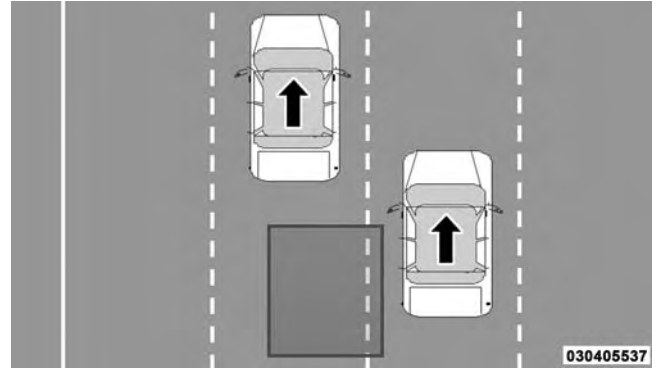

Overtaking/Approaching

The BSM system is designed not to issue an alert on stationary objects such as guardrails, posts, walls, foliage,

## 128 UNDERSTANDING THE FEATURES OF YOUR VEHICLE

berms, etc. However, occasionally the system may alert on such objects. This is normal operation and your vehicle does not require service.

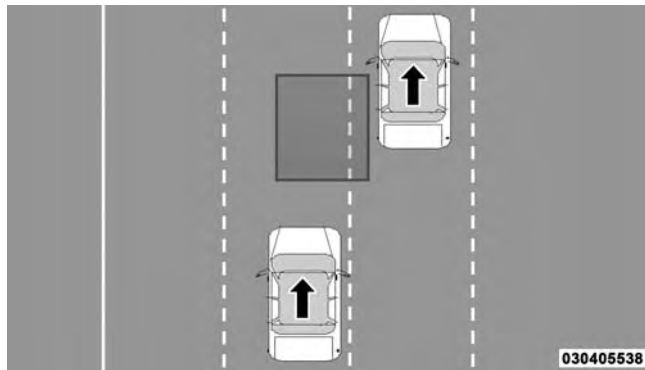

### Overtaking/Passing

The BSM system will not alert you of objects that are traveling in the opposite direction of the vehicle in adjacent lanes.

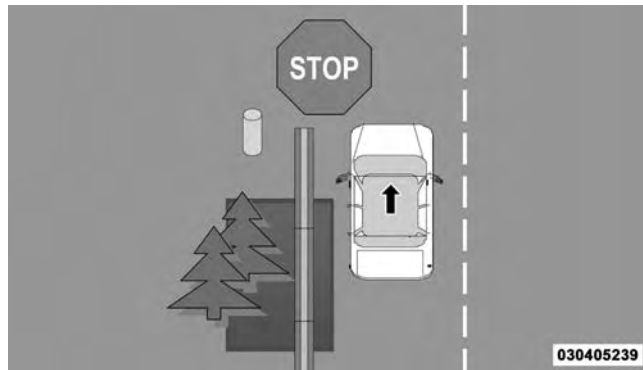

### Stationary Objects

**WARNING!**

The Blind Spot Monitoring system is only an aid to help detect objects in the blind spot zones. The BSM system is not designed to detect pedestrians, bicyclists, or animals. Even if your vehicle is equipped with the BSM system, always check your vehicle's mirrors, glance over your shoulder, and use your turn signal before changing lanes. Failure to do so can result in serious injury or death.

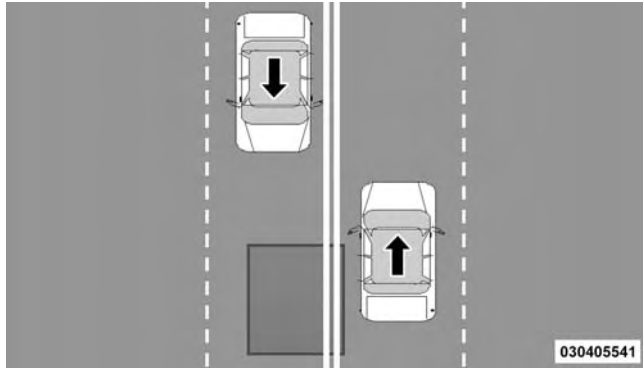
**3**

Opposing Traffic

## Rear Cross Path

The Rear Cross Path (RCP) feature is intended to aid the drivers when backing out of parking spaces where their vision of oncoming vehicles may be blocked. Proceed slowly and cautiously out of the parking space until the rear end of the vehicle is exposed. The RCP system will then have a clear view of the cross traffic and if an oncoming vehicle is detected, alert the driver.

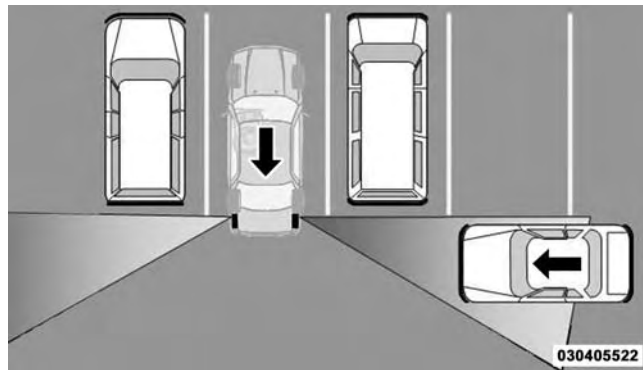

### RCP Detection Zones

RCP monitors the rear detection zones on both sides of the vehicle, for objects that are moving toward the side of the vehicle with a minimum speed of approximately 3 mph (5 km/h), to objects moving a maximum of approximately 20 mph (32 km/h), such as in parking lot situations.

**NOTE:** In a parking lot situation, oncoming vehicles can be obscured by vehicles parked on either side. If the sensors are blocked by other structures or vehicles, the system will not be able to alert the driver.

When RCP is on and the vehicle is in REVERSE, the driver is alerted using both the visual and audible alarms, including reducing the radio volume.

### **WARNING!**

**RCP is not a Back Up Aid system. It is intended to be used to help a driver detect an oncoming vehicle in a parking lot situation. Drivers must be careful when backing up, even when using RCP. Always check carefully behind your vehicle, look behind you, and be sure to check for pedestrians, animals, other vehicles, obstructions, and blind spots before backing up. Failure to do so can result in serious injury or death.**

## **Modes Of Operation**

### **Modes Of Operation With EVIC**

Three selectable modes of operation are available in the Electronic Vehicle Information Center (EVIC). Refer to “Electronic Vehicle Information Center (EVIC)/Personal Settings (Customer-Programmable Features)” in “Understanding Your Instrument Panel” for further information.

### **Modes Of Operation With Uconnect® System — If Equipped**

Three selectable modes of operation are available in the Uconnect® system screen. Refer to “Customer- Programmable Features — Uconnect® Access Settings” in “Understanding Your Instrument Panel” for further information.

### **Blind Spot Alert Lights Only**

When operating in Blind Spot Alert mode, the BSM system will provide a visual alert in the appropriate side

view mirror based on a detected object. However, when the system is operating in RCP, the system will respond with both visual and audible alerts when a detected object is present. Whenever an audible alert is requested, the radio volume is reduced.

### **Blind Spot Alert Lights/Chime**

When operating in Blind Spot Alert Lights/Chime mode, the BSM system will provide a visual alert in the appropriate side view mirror based on a detected object. If the turn signal is then activated, and it corresponds to an alert present on that side of the vehicle, an audible chime will also be sounded. Whenever a turn signal and detected object are present on the same side at the same time, both the visual and audio alerts will be issued. In addition to the audible alert the radio (if on) volume will be reduced.

### **NOTE:**

- Whenever an audible alert is requested by the BSM system, the radio volume is reduced.
- If the hazard flashers are on, the system will request the appropriate visual alert only.

When the system is in RCP, the system shall respond with both visual and audible alerts when a detected object is present. Whenever an audible alert is requested, the radio volume is reduced. Turn/hazard signal status is ignored; the RCP state always requests the chime.

### **Blind Spot Alert Off**

When the BSM system is turned off there will be no visual or audible alerts from either the BSM or RCP systems.

**NOTE:** The BSM system will store the current operating mode when the vehicle is shut off. Each time the vehicle is started the previously stored mode will be recalled and used.

### **Uconnect® Phone (Uconnect® 200)**

Uconnect® Phone is a voice-activated, hands-free, in-vehicle communications system. Uconnect® Phone allows you to dial a phone number with your mobile phone using simple voice commands (e.g., “Call” ... “Mike” ... “Work” or “Dial” ... “248-555-1212”). Your mobile phone’s audio is transmitted through your vehicle’s audio system; the system will automatically mute your radio when using the Uconnect® Phone.

**NOTE:** The Uconnect® Phone requires a mobile phone equipped with the Bluetooth® “Hands-Free Profile”, Version 0.96 or higher. See the Uconnect® website for supported phones.

For Uconnect® phone compatibility - visit <http://www.UconnectPhone.com> or call 1-877-855-8400. Canadian Residents – visit <http://www.UconnectPhone.com> or call, 1-800-465-2001 (English) or 1-800-387-9983 (French).

For additional information on Uconnect®:

- U.S. residents - visit <http://www.DriveUconnect.com> or call 1-877-855-8400.
- Canadian Residents - visit <http://www.DriveUconnect.ca> or call, 1-800-465-2001 (English) or 1-800-387-9983 (French).



Uconnect® Phone allows you to transfer calls between the system and your mobile phone as you enter or exit your vehicle and enables you to mute the system’s microphone for private conversation.

Uconnect® features Bluetooth® technology - the global standard that enables different electronic devices to connect to each other without wires or a docking station, so Uconnect® Phone works no matter where you stow your mobile phone (be it your purse, pocket, or briefcase), as long as your phone is turned on and has been paired to the vehicle's Uconnect® Phone. The Uconnect® Phone allows up to seven mobile phones to be linked to the system. Only one linked (or paired) mobile phone can be used with the system at a time. The system is available in English, Spanish, or French languages.

**WARNING!**

**Any voice commanded system should be used only in safe driving conditions following all applicable laws, including laws regarding phone use. Your attention should be focused on safely operating the vehicle. Failure to do so may result in a collision causing serious injury or death.**

*Uconnect® Phone Button*

The steering wheel controls will contain the two control buttons (Uconnect® Phone  button and Voice Command  button) that will enable you to access the system. When you press the Uconnect® Phone  button you will hear a BEEP. The beep is your signal to give a command.



### Voice Command Button

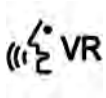

When you press the Voice Command  button you will hear a BEEP. The beep is your signal to give a command.

The Uconnect® Phone can be used with any Hands-Free Profile certified Bluetooth® mobile phone. See the Uconnect® website for supported phones. Refer to your mobile service provider or the phone manufacturer for details.

The Uconnect® Phone is fully integrated with the vehicle's audio system. The volume of the Uconnect® Phone can be adjusted either from the radio volume control knob or from the steering wheel radio control (right switch), if so equipped.

The radio display will be used for visual prompts from the Uconnect® Phone such as “Phone” or caller ID.

### Operation

Voice commands can be used to operate the Uconnect® Phone and to navigate through the Uconnect® Phone menu structure. Voice commands are required after most Uconnect® Phone prompts. You will be prompted for a specific command and then guided through the available options.

- Prior to giving a voice command, one must wait for the beep.
- For certain operations, compound commands can be used. For example, instead of saying “Setup”, “Device Pairing” and then “Pair a Device”, the following compound command can be said: “Setup”, “Device Pairing” and “Pair a Bluetooth® Device”.
- For each feature explanation in this section, only the compound form of the voice command is given. You can also break the commands into parts and say each



part of the command when you are asked for it. For example, you can use the compound form voice command “Phonebook New Entry”, or you can break the compound form command into two voice commands: “Phonebook” and “New Entry”. Please remember, the Uconnect® Phone works best when you talk in a normal conversational tone, as if speaking to someone sitting a few feet/meters away from you.

### **Voice Command Tree**

Refer to “Voice Tree” in this section.

### **Help Command**

If you need assistance at any prompt, or if you want to know your options at any prompt, say “Help” following the beep. The Uconnect® Phone will then play some of the options.

To activate the Uconnect® Phone, simply press the  button and follow the audible prompts for directions. Uconnect® Phone sessions begin with a press of the  button on the steering wheel.

### **Cancel Command**

At any prompt, after the beep, you can say “Cancel” and you will be returned to the main menu. However, in a few instances the system will take you back to the previous menu.

### **Pair (Link) Uconnect® Phone To A Mobile Phone**

To begin using your Uconnect® Phone, you must pair your compatible Bluetooth® enabled mobile phone.

To complete the pairing process, you will need to reference your mobile phone Owner’s Manual. The Uconnect® website may also provide detailed instructions for pairing.

**NOTE:** If other phones are present during the pairing process make sure they are switched to off or the bluetooth is disabled before proceeding.

The following are general phone to Uconnect® Phone pairing instructions:

- Press the  button to begin.
- After the “Ready” prompt and the following beep, say “Device Pairing”.
- When prompted, after the beep, say “Pair a Device” and follow the audible prompts.
- For identification purposes, you will be prompted to give the Uconnect® Phone a name for your mobile phone. Each mobile phone that is paired should be given a unique phone name.
- You will then be asked “Should paired device be set as Favorite?” If yes this phone will become the highest

priority. You can pair up to seven mobile phones to your Uconnect® Phone. However, at any given time, only one mobile phone can be in use, connected to your Uconnect® System. The priority allows the Uconnect® Phone to know which mobile phone to use if multiple mobile phones are in the vehicle at the same time.

- Start pairing procedure on device. See device manual for instructions.
- Select Uconnect® on the device and enter the four-digit Personal Identification Number (PIN) displayed on radio into your mobile phone.

### Dial By Saying A Number

- Press the  button to begin.
- After the “Ready” prompt and the following beep, say “Dial.”

- The system will prompt you to say the number you want to call.
- For example, you can say “151-1234-5555.”
- The Uconnect® Phone will confirm the phone number and then dial. The number will appear in the display of certain radios.

### **Call By Saying A Name**

- Press the  button to begin.
- After the “Ready” prompt and the following beep, say “Call”.
- The system will prompt you to say the name of the person you want to call.
- After the “Ready” prompt and the following beep, say the name of the person you want to call. For example, you can say “john doe” or “john doe, mobile”, where John Doe is a previously stored name entry in the

Uconnect® phonebook or downloaded phonebook. To learn how to store a name in the phonebook, refer to “Add Names to Your Uconnect® Phonebook”, in the phonebook.

- The Uconnect® system will confirm the name and then dial the corresponding phone number, which may appear in the display of certain radios.

### **Phonebook Download — Automatic Phonebook Transfer From Mobile Phone**

If equipped and specifically supported by your phone, Uconnect® Phone automatically downloads names (text names) and number entries from your mobile phone’s phonebook. Specific Bluetooth® Phones with Phone Book Access Profile may support this feature. See Uconnect® website for supported phones.

- To call a name from the Uconnect® Phonebook or downloaded Phonebook, follow the procedure in “Call by Saying a Name” section.
- Automatic download and update, if supported, begins as soon as the Bluetooth® wireless phone connection is made to the Uconnect® Phone, for example, after you start the vehicle.
- A maximum of 1000 entries per phone will be downloaded and updated every time a phone is connected to the Uconnect® Phone.
- Depending on the maximum number of entries downloaded, there may be a short delay before the latest downloaded names can be used. Until then, if available, the previously downloaded phonebook is available for use.
- Only the phonebook of the currently connected mobile phone is accessible.
- Only the mobile phone’s phonebook is downloaded. SIM card phonebook is not part of the Mobile phonebook. However, if there is less than 10 contacts in the mobile phone, the SIM contacts may also download.
- This downloaded phonebook cannot be edited or deleted on the Uconnect® Phone. These can only be edited on the mobile phone. The changes are transferred and updated to Uconnect® Phone on the next phone connection.

### Add Names To Your Uconnect® Phonebook

**NOTE:** Adding names to the Uconnect® Phonebook is recommended when the vehicle is not in motion.

- Press the  button to begin.
- After the “Ready” prompt and the following beep, say “Phonebook New Entry.”

- When prompted, say the name of the new entry. Use of long names helps the Voice Command and it is recommended. For example, say “Robert Smith” or “Robert” instead of “Bob.”
- When prompted, enter the number designation (e.g., “Home”, “Work”, “Mobile”, or “Other”). This will allow you to store multiple numbers for each phonebook entry, if desired.
- When prompted, recite the phone number for the phonebook entry that you are adding.

After you are finished adding an entry into the phonebook, you will be given the opportunity to add more phone numbers to the current entry or to return to the main menu.

The Uconnect® Phone will allow you to enter up to 32 names in the phonebook with each name having up to four associated phone numbers and designations. Each

language has a separate 32-name phonebook accessible only in that language. In addition, if equipped and supported by your phone, Uconnect® Phone automatically downloads your mobile phone’s phonebook.

### Edit Uconnect® Phonebook Entries

**NOTE:** Editing phonebook entries is recommended when the vehicle is not in motion. Automatic downloaded phonebook entries cannot be deleted or edited.

- Press the  button to begin.
- After the “Ready” prompt and the following beep, say “Phonebook Edit.”
- You will then be asked for the name of the phonebook entry that you wish to edit.
- Next, choose the number designation (home, work, mobile, or other) that you wish to edit.

- When prompted, recite the new phone number for the phonebook entry that you are editing.

After you are finished editing an entry in the phonebook, you will be given the opportunity to edit another entry in the phonebook, call the number you just edited, or return to the main menu.

“Phonebook Edit” can be used to add another phone number to a name entry that already exists in the phonebook. For example, the entry John Doe may have a mobile and a home number, but you can add “John Doe’s” work number later using the “Phonebook Edit” feature.

### Delete Uconnect® Phonebook Entry



**NOTE:** Editing phonebook entries is recommended when the vehicle is not in motion.

- Press the  button to begin.

- After the “Ready” prompt and the following beep, say “Phonebook Delete.”
- After you enter the Phonebook Delete menu, you will then be asked for the name of the entry that you wish to delete. You can either say the name of a phonebook entry that you wish to delete or you can say “List Names” to hear a list of the entries in the phonebook from which you choose. To select one of the entries from the list, press the  button while the Uconnect® Phone is playing the desired entry and say “Delete.”
- After you enter the name, the Uconnect® Phone will ask you which designation you wish to delete: home, work, mobile, other, or all. Say the designation you wish to delete.
- Note that only the phonebook entry in the current language is deleted.

- Automatic downloaded phonebook entries cannot be deleted or edited.

### List All Uconnect® Phonebook Names

- Press the  button to begin.
- After the “Ready” prompt and the following beep, say “Phonebook List Names.”
- The Uconnect® Phone will play the names of all the phonebook entries, including the downloaded phonebook entries, if available.
- To call one of the names in the list, press the  button during the playing of the desired name, and say “Call.”

**NOTE:** The user can also exercise “Edit” or “Delete” operations at this point.

- The Uconnect® Phone will then prompt you as to the number designation you wish to call.

- The selected number will be dialed.



### Phone Call Features

The following features can be accessed through the Uconnect® Phone if the feature(s) are available on your cellular service plan. For example, if your cellular service plan provides three-way calling, this feature can be accessed through the Uconnect® Phone. Check with your cellular service provider for the features that you have.

### Answer Or Reject An Incoming Call — No Call Currently In Progress

When you receive a call on your cellular phone, you will have the option of Answer, Ignore, or Transfer. The cursor will begin on Answer. Rotating the scroll knob will move between the options, pressing Enter will select the current item. After accepting the call, the options on the screen will be End, Transfer, Hold, and Mute. The top line will display the contact, if the contact is not in the phonebook or the phonebook has not been downloaded



the phone number will be displayed on the screen. Press the  button to accept the call. To reject the call, press and hold the  button until you hear a single beep, indicating that the incoming call was rejected.

### **Answer Or Reject An Incoming Call — Call Currently In Progress**



If a call is currently in progress and you have another incoming call, you will hear the same network tones for call waiting that you normally hear when using your mobile phone. Press the  button to place the current call on hold and answer the incoming call.

**NOTE:** The Uconnect® Phone compatible phones in the market today do not support rejecting an incoming call when another call is in progress. Therefore, the user can only answer an incoming call or ignore it.

### **Making A Second Call While Current Call Is In Progress**

To make a second call while you are currently on a call, press the  button and say “Dial” or “Call” followed by the phone number or phonebook entry you wish to call. The first call will be on hold while the second call is in progress. To go back to the first call, refer to “Toggling Between Calls” in this section. To combine two calls, refer to “Conference Call” in this section.

### **Place/Retrieve A Call From Hold**

To put a call on hold, press the  button until you hear a single beep. This indicates that the call is on hold. To bring the call back from hold, press and hold the  button until you hear a single beep.

### Toggling Between Calls

If two calls are in progress (one active and one on hold), press the  button until you hear a single beep, indicating that the active and hold status of the two calls have switched. Only one call can be placed on hold at a time.

### Conference Call



When two calls are in progress (one active and one on hold), press and hold the  button until you hear a double beep indicating that the two calls have been joined into one conference call.

### Three-Way Calling

To initiate three-way calling, press the  button while a call is in progress, and make a second phone call, as described under “Making a Second Call While Current Call is in Progress.” After the second call has established,

press and hold the  button until you hear a double beep, indicating that the two calls have been joined into one conference call.

### Call Termination

To end a call in progress, momentarily press the  button. Only the active call(s) will be terminated and if there is a call on hold, it will become the new active call. If the active call is terminated by the phone far end, a call on hold may not become active automatically. This is cell phone-dependent. To bring the call back from hold, press and hold the  button until you hear a single beep.

### Redial

- Press the  button to begin.
- After the “Ready” prompt and the following beep, say “Redial.”

- The Uconnect® Phone will call the last number that was dialed from your mobile phone.

**NOTE:** This may not be the last number dialed from the Uconnect® Phone.

### Call Continuation

Call continuation is the progression of a phone call on the Uconnect® Phone after the vehicle ignition key has been switched to OFF. Call continuation functionality available on the vehicle can be any one of three types:

- After the ignition key is switched to OFF, a call can continue on the Uconnect® Phone either until the call ends, or until the vehicle battery condition dictates cancellation of the call on the Uconnect® Phone and transfer of the call to the mobile phone.

- After the ignition key is switched to OFF, a call can continue on the Uconnect® Phone for a certain duration, after which the call is automatically transferred from the Uconnect® Phone to the mobile phone.

### Uconnect® Phone Features

#### Language Selection

To change the language that the Uconnect® Phone is using:

- Press the  button to begin.
- After the “Ready” prompt and the following beep, say the name of the language you wish to switch to English, Espanol, or Francais.
- Continue to follow the system prompts to complete the language selection.

After selecting one of the languages, all prompts and voice commands will be in that language.

**NOTE:** After every Uconnect® Phone language change operation, only the language-specific 32-name phonebook is usable. The paired phone name is not language-specific and is usable across all languages.

### Emergency Assistance

If you are in an emergency and the mobile phone is reachable:

- Pick up the phone and manually dial the emergency number for your area.

If the phone is not reachable and the Uconnect® Phone is operational, you may reach the emergency number as follows:

- Press the  button to begin.
- After the “Ready” prompt and the following beep, say “Emergency” and the Uconnect® Phone will instruct

the paired mobile phone to call the emergency number. This feature is supported in the U.S., Canada, and Mexico.

### NOTE:

- The emergency number dialed is based on the country where the vehicle is purchased (911 for the U.S., Canada, and Mexico). The number dialed may not be applicable with the available mobile service and area.
- If supported, this number may be programmable on some systems. To do this, press the  button and say “Setup”, followed by “Emergency”.
- The Uconnect® Phone does slightly lower your chances of successfully making a phone call as compared to using the mobile phone directly.

**WARNING!**

To use your Uconnect® Phone System in an emergency, your mobile phone must be:

- turned on,
- paired to the Uconnect® System,
- and have network coverage.

**Roadside Assistance**

If you need roadside assistance:

- Press the  button to begin.
- After the “Ready” prompt and the following beep, say “Roadside Assistance”.

**NOTE:**

- The roadside assistance number dialed is based on the country where the vehicle is purchased (1-800-528-2069 for the U.S., 1-877-213-4525 for Canada, 55-14-3454 for Mexico City and 1-800-712-3040 for outside Mexico City in Mexico). Please refer to the 24-Hour “Roadside Assistance” coverage details on the DVD in the Warranty Information Booklet and the 24-Hour Roadside Assistance references.
- If supported, this number may be programmable on some systems. To do this, press the  button and say “Setup”, followed by “Roadside Assistance”.

**Paging**

To learn how to page, refer to “Working with Automated Systems.” Paging works properly except for pagers of certain companies, which time out a little too soon to work properly with the Uconnect® Phone.

## Voice Mail Calling

To learn how to access your voice mail, refer to "Working with Automated Systems."

## Working With Automated Systems

This method is used in instances where one generally has to press numbers on the mobile phone keypad while navigating through an automated telephone system.

You can use your Uconnect® Phone to access a voice mail system or an automated service, such as a paging service or automated customer service line. Some services require immediate response selection. In some instances, that may be too quick for use of the Uconnect® Phone.

When calling a number with your Uconnect® Phone that normally requires you to enter in a touch-tone sequence on your mobile phone keypad, you can press the  button and say the sequence you wish to enter, followed by the word "Send". For example, if required to

enter your PIN followed with a pound, (3 7 4 6 #), you can press the  button and say, "3 7 4 6 # Send". Saying a number, or sequence of numbers, followed by "Send", is also to be used for navigating through an automated customer service center menu structure, and to leave a number on a pager.

You can also send stored Uconnect® phonebook entries as tones for fast and easy access to voice mail and pager entries. To use this feature, dial the number you wish to call and then press the  button and say, "Send." The system will prompt you to say the "number." If you wish to send the name say "Send Name" followed by a valid name from the phonebook. Uconnect® Phone will then send the corresponding phone number associated with the phonebook entry, as tones over the phone.

### NOTE:

- You may not hear all of the tones due to mobile phone network configurations. This is normal.

- Some paging and voice mail systems have system time out settings that are too short and may not allow the use of this feature.
- After the “Ready” prompt and the following beep, say one of the following:
  - “Setup Confirmation Prompts On”
  - “Setup Confirmation Prompts Off”

### Barge In — Overriding Prompts

The “Voice Command” button can be used when you wish to skip part of a prompt and issue your voice command immediately. For example, if a prompt is asking “Would you like to pair a phone, clear a...,” you could press the  button and say, “Pair a Phone” to select that option without having to listen to the rest of the voice prompt.

### Turning Confirmation Prompts ON/OFF

Turning confirmation prompts off will stop the system from confirming your choices (e.g., the Uconnect® Phone will not repeat a phone number before you dial it).

- Press the  button to begin.

### Phone And Network Status Indicators

If available on the radio and/or on a premium display such as the instrument panel cluster, and supported by your mobile phone, the Uconnect® Phone will provide notification to inform you of your phone and network status when you are attempting to make a phone call using Uconnect® Phone. The status is given for network signal strength, phone battery strength, etc.

### Dialing Using The Mobile Phone Keypad

You can dial a phone number with your mobile phone keypad and still use the Uconnect® Phone (while dialing via the mobile phone keypad, the user must exercise caution and take precautionary safety measures). By

dialing a number with your paired Bluetooth® mobile phone, the audio will be played through your vehicle's audio system. The Uconnect® Phone will work the same as if you dial the number using Voice Command.

**NOTE:** Certain brands of mobile phones do not send the dial ring to the Uconnect® Phone to play it on the vehicle audio system, so you will not hear it. Under this situation, after successfully dialing a number the user may feel that the call did not go through even though the call is in progress. Once your call is answered, you will hear the audio.

### **Mute/Un-Mute (Mute ON/OFF)**

When you mute the Uconnect® Phone, you will still be able to hear the conversation coming from the other party, but the other party will not be able to hear you. To mute the Uconnect® Phone:

- Press the  button.

- Following the beep, say "Mute."

To un-mute the Uconnect® Phone:

- Press the  button.
- Following the beep, say "Mute off."

### **Advanced Phone Connectivity**

#### **Transfer Call To And From Mobile Phone**

The Uconnect® Phone allows ongoing calls to be transferred from your mobile phone to the Uconnect® Phone without terminating the call. To transfer an ongoing call from your Uconnect® Phone paired mobile phone to the Uconnect® Phone or vice versa, press the  button and say "Transfer Call."





## Connect Or Disconnect Link Between The Uconnect® Phone And Mobile Phone

Your mobile phone can be paired with many different electronic devices, but can only be actively “connected” with one electronic device at a time.

If you would like to connect or disconnect the Bluetooth® connection between your mobile phone and the Uconnect® Phone System, follow the instructions described in your mobile phone User’s Manual.



### List Paired Mobile Phone Names

- Press the  button to begin.
- After the “Ready” prompt and the following beep, say “Setup Phone Pairing.”
- When prompted, say “List Phones.”
- The Uconnect® Phone will play the phone names of all paired mobile phones in order from the highest to the

lowest priority. To “Select” or “Delete” a paired phone being announced, press the  button and say “Select” or “Delete.” Also, see the next two sections for an alternate way to “Select” or “Delete” a paired phone.



### Select Another Mobile Phone

This feature allows you to select and start using another phone paired with the Uconnect® Phone.

- Press the  button to begin.
- After the “Ready” prompt and the following beep, say “Setup Select Phone” and follow the prompts.
- You can also press the  button at any time while the list is being played, and then choose the phone that you wish to select.
- The selected phone will be used for the next phone call. If the selected phone is not available, the

Uconnect® Phone will return to using the highest priority phone present in or near (approximately within 30 ft. (9 m)) the vehicle.

### Delete Uconnect® Phone Paired Mobile Phones

- Press the  button to begin.
- After the “Ready” prompt and the following beep, say “Setup Phone Pairing.”
- At the next prompt, say “Delete” and follow the prompts.
- You can also press the  button at any time while the list is being played, and then choose the phone you wish to delete.

### Things You Should Know About Your Uconnect® Phone

#### Uconnect® Phone Tutorial

To hear a brief tutorial of the system features, press the  button and say “Uconnect® Tutorial.”

#### Voice Training

For users experiencing difficulty with the system recognizing their voice commands or numbers, the Uconnect® Phone Voice Training feature may be used. To enter this training mode, follow one of the two following procedures:

From outside the Uconnect® Phone mode (e.g., from radio mode):

- Press and hold the  button for five seconds until the session begins, or,

- Press the  button and say the “Voice Training,” “System Training,” or “Start Voice Training” command.

You can either press the Uconnect® Phone button to restore the factory setting or repeat the words and phrases when prompted by the Uconnect® Phone. For best results, the Voice Training session should be completed when the vehicle is parked with the engine running, all windows closed, and the blower fan switched off.

This procedure may be repeated with a new user. The system will adapt to the last trained voice only.

### Reset

- Press the  button.
- After the “Ready” prompt, and the following beep, say “Setup,” then “Reset.”

This will delete all phone pairing, phone book entries, and other settings in all language modes. The System will prompt you before resetting to factory settings.

### Voice Command

#### Uconnect® Voice Command Tutorial

To hear a brief tutorial of the Voice Command features, press the  button and say “Voice Command Tutorial.”

- For best performance, adjust the rearview mirror to provide at least ½ inch (1 cm) gap between the overhead console (if equipped) and the mirror.
- Always wait for the beep before speaking.
- Speak normally, without pausing, just as you would speak to a person sitting a few feet/meters away from you.

- Make sure that no one other than you is speaking during a Voice Command period.
- Performance is maximized under:
  - Low-To-Medium Blower Setting.
  - Low-To-Medium Vehicle Speed.
  - Low Road Noise.
  - Smooth Road Surface.
  - Fully Closed Windows.
  - Dry Weather Condition.
- Even though the system is designed for users speaking in North American English, French, and Spanish accents, the system may not always work for some.
- When navigating through an automated system such as voice mail, or when sending a page, at the end of speaking the digit string, make sure to say "Send".
- Storing names in the phonebook when the vehicle is not in motion is recommended.
- It is not recommended to store similar sounding names in the Uconnect® Phonebook.
- Phonebook (Downloaded and Uconnect® Phone Local) name recognition rate is optimized when the entries are not similar.
- Numbers must be spoken in single digits. "800" must be spoken "eight-zero-zero" not "eight hundred".
- You can say "O" (letter "O") for "0" (zero).
- Even though international dialing for most number combinations is supported, some shortcut dialing number combinations may not be supported.
- In a convertible vehicle, system performance may be compromised with the convertible top down.

### Far End Audio Performance

- Audio quality is maximized under:
- Low-To-Medium Blower Setting
- Low-To-Medium Vehicle Speed
- Low Road Noise
- Smooth Road Surface
- Fully Closed Windows
- Dry Weather Conditions
- Operation From The Driver's Seat
- Performance, such as audio clarity, echo, and loudness to a large degree rely on the phone and network, and not the Uconnect® Phone
- Echo at the phone far end can sometimes be reduced by lowering the in-vehicle audio volume

- In a convertible vehicle, system performance may be compromised with the convertible top down

### Power-Up

After switching the ignition key from OFF to either the ON or ACC position, or after a language change, you must wait at least 15 seconds prior to using the system.

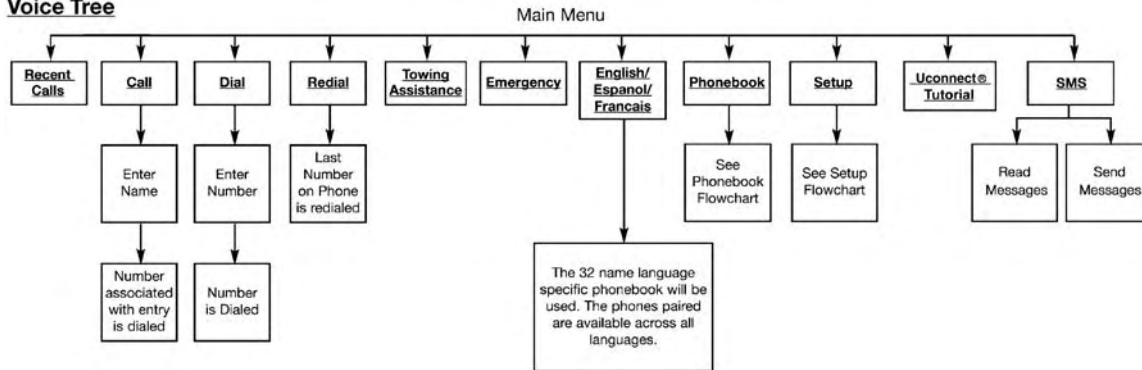
**Voice Tree**

**Note:** Available Voice commands are shown in bold face and are underlined.

**Voice Tree – Phonebook**

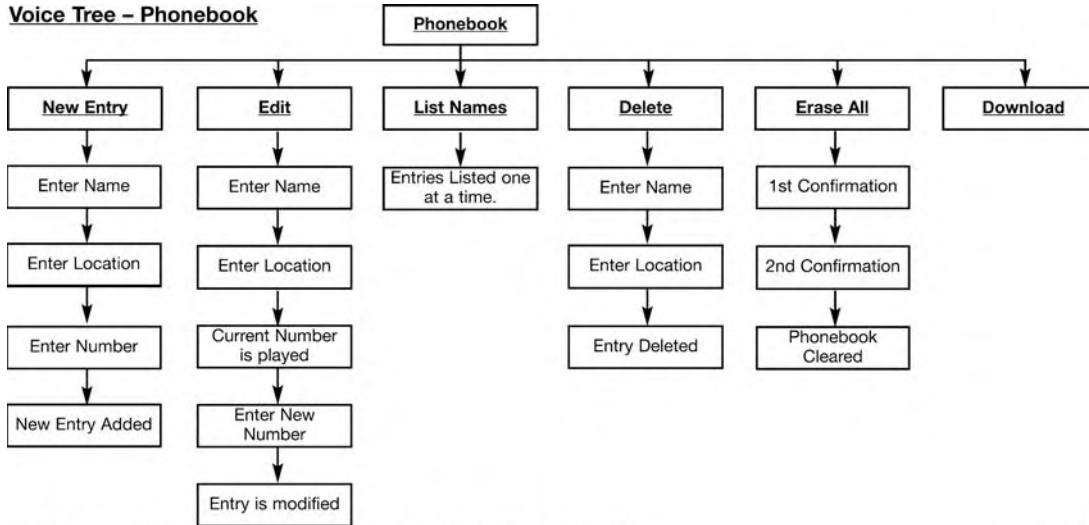

**Note:** Available Voice commands are shown in bold face and are underlined.

81c6bf80

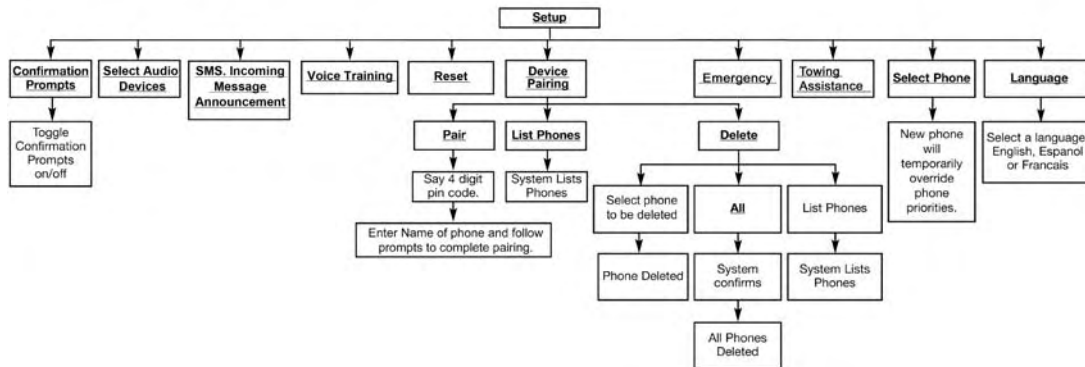
**Voice Tree – Setup**

**Note:** Available Voice commands are shown in bold face and are underlined.

030605540



Voice Commands	
Primary	Alternate (s)
zero	
one	
two	
three	
four	
five	
six	
seven	
eight	
nine	
star (*)	
plus (+)	
pound (#)	
add location	

Voice Commands	
Primary	Alternate (s)
all	
call	
cancel	
confirmation prompts	
continue	
delete	
dial	
download	
edit	
emergency	
English	
erase all	
Espanol	
Francais	

Voice Commands	
Primary	Alternate (s)
help	
home	
language	
list names	
list phones	
mobile	
mute	
mute off	
new entry	
no	
other	
pair a phone	
phone pairing	pairing
phonebook	phone book

Voice Commands	
Primary	Alternate (s)
previous	
record again	
redial	
return to main menu	return or main menu
select phone	select
send	
set up	phone settings or phone set up
towing assistance	
transfer call	
Uconnect® Tutorial	
voice training	
work	
yes	

## Voice Text Reply

Uconnect® Phone can read or send new messages on your phone.

### Read Messages:

If you receive a new text message while your phone is connected to Uconnect® Phone and your phone is supported, an announcement will be made to notify you that you have a new text message. If you wish to hear the new message:

- Press the  button.
- After the “Ready” prompt and the following beep, say “SMS Read” or “Read Messages.”
- Uconnect® Phone will play the new text message for you.

After reading a message, you can “Reply” or “Forward” the message using Uconnect® Phone.

### Send Messages:

You can send messages using Uconnect® Phone. To send a new message:

- Press the  button.
- After the “Ready” prompt and the following beep, say “SMS Send” or “Send Message.”
- You can either say the message you wish to send or say “List Messages.” There are 20 preset messages.

To send a message, press the  button while the system is listing the message and say “Send.”

Uconnect® Phone will prompt you to say the name or number of the person you wish to send the message to.

List of Preset Messages:

1. Yes
2. No

3. Where are you?
4. I need more direction.
5. L O L
6. Why
7. I love you
8. Call me
9. Call me later
10. Thanks
11. See You in 15 minutes
12. I am on my way
13. I'll be late
14. Are you there yet?
15. Where are we meeting?

16. Can this wait?
17. Bye for now
18. When can we meet
19. Send number to call
20. Start without me

### **Turn SMS Incoming Announcement ON/OFF**

Turning the SMS Incoming Announcement OFF will stop the system from announcing the new incoming messages.

- Press the  button.
- After the "Ready" prompt and the following beep, say "Setup, SMS Incoming Message Announcement," you will then be given a choice to change it.

## Bluetooth® Communication Link

Mobile phones have been found to lose connection to the Uconnect® Phone. When this happens, the connection can generally be reestablished by switching the phone off/on. Your mobile phone is recommended to remain in Bluetooth® ON mode.

### General Information

This device complies with Part 15 of the FCC rules and RSS 210 of Industry Canada. Operation is subject to the following conditions:

- Changes or modifications not expressly approved by the party responsible for compliance could void the user's authority to operate the equipment.
- This device may not cause harmful interference.
- This device must accept any interference received, including interference that may cause undesired operation.

## Uconnect® Phone (8.4/8.4N)

### Uconnect® 8.4/8.4Nav

Uconnect® Phone is a voice-activated, hands-free, in-vehicle communications system. Uconnect® Phone allows you to dial a phone number with your mobile phone.

Uconnect® Phone supports the following features:

#### Voice Activated Features:

- Hands Free dialing via Voice (“Call John Smith Mobile” or, “Dial 248 555 1212”).
- Hands Free text to speech listening of your incoming SMS messages.
- Hands Free text messaging (“Send a message to John Smith Mobile”).
- Redialing last dialed numbers (“Redial”).

- Calling Back the last incoming call number (“Call Back”).
- View Call logs on screen (“Show incoming calls”, “Show Outgoing calls”, “Show missed Calls”, “Show Recent Calls”).
- Searching Contacts phone number (“Search for John Smith Mobile”).

### Screen Activated Features

- Dialing via Keypad using touchscreen.
- Viewing and Calling contacts from Phonebooks displayed on the touchscreen.
- Setting Favorite Contact Phone numbers so they are easily accessible on the Main Phone screen.
- Viewing and Calling contacts from Recent Call logs.
- Reviewing your recent Incoming SMS.

- Sending a text message via the touchscreen.
- Listen to Music on your Bluetooth® Device via the touchscreen.
- Pairing up to 10 phones/audio devices for easy access to connect to them quickly.

**NOTE:** Your phone must be capable of SMS messaging via Bluetooth® for messaging features to work properly. Your mobile phone’s audio is transmitted through your vehicles audio system; the system will automatically mute your radio when using the Uconnect® Phone. For Uconnect® customer support, visit the following web-site:

- U.S. residents - visit [www.UconnectPhone.com](http://www.UconnectPhone.com) or call 1-877-855-8400.
- Canadian residents - visit [www.UconnectPhone.com](http://www.UconnectPhone.com) or call 1-800-465-2001 (English) or 1-800-387-9983 (French).

Uconnect® Phone allows you to transfer calls between the system and your mobile phone as you enter or exit your vehicle and enables you to mute the system's microphone for private conversation.

### WARNING!

**Any voice commanded system should be used only in safe driving conditions following all applicable laws, including laws regarding phone use. Your attention should be focused on safely operating the vehicle. Failure to do so may result in an accident causing serious injury or death.**

The Uconnect® Phone is driven through your Bluetooth® "Hands-Free Profile" mobile phone. Uconnect® features Bluetooth® technology - the global standard that enables different electronic devices to connect to each other without wires or a docking station, so Uconnect® Phone works no matter where you stow your

mobile phone (be it your purse, pocket, or briefcase), as long as your phone is turned on and has been paired to the vehicle's Uconnect® Phone. The Uconnect® Phone allows up to ten mobile phones or audio devices to be linked to the system. Only one linked (or paired) mobile phone and one audio device can be used with the system at a time. The system is available in English, Spanish, or French languages.

### *Uconnect® Phone Button*



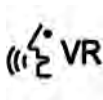

The Uconnect® Phone  Button is used to enter the phone mode and make calls, show recent, incoming, outgoing calls, view phone-book etc., When you press the button you will hear a BEEP. The beep is your signal to give a command.

### Uconnect® Voice Command Button



The Uconnect® Voice Command  Button is only used for “barge in” and when you are already in a call and you want to send Tones or make another call.

The  button is also used to access the Voice Commands for the Uconnect® Voice Command features if your vehicle is equipped. Please see the Uconnect® Voice Command section for direction on how to use the  button.

The Uconnect® Phone is fully integrated with the vehicle's audio system. The volume of the Uconnect® Phone can be adjusted either from the radio volume control knob or from the steering wheel radio control (right switch), if so equipped.

### Operation

Voice commands can be used to operate the Uconnect® Phone and to navigate through the Uconnect® Phone menu structure. Voice commands are required after most Uconnect® Phone prompts. There are two general methods for how Voice Command works:

1. Say compound commands like “Call John Smith mobile.”
2. Say the individual commands and allow the system to guide you to complete the task.

You will be prompted for a specific command and then guided through the available options.

- Prior to giving a voice command, one must wait for the beep, which follows the “Listen” prompt or another prompt.
- For certain operations, compound commands can be used. For example, instead of saying “Call” and then



“John Smith” and then “mobile”, the following compound command can be said: “Call John Smith mobile.”

- For each feature explanation in this section, only the compound command form of the voice command is given. You can also break the commands into parts and say each part of the command when you are asked for it. For example, you can use the compound command form voice command “Search for John Smith,” or you can break the compound command form into two voice commands: “Search Contact” and when asked “John Smith.” Please remember, the Uconnect® Phone works best when you talk in a normal conversational tone, as if speaking to someone sitting a few feet/meters away from you.

### Natural Speech

Your Uconnect® Phone Voice system uses a Natural Language Voice Recognition (VR) engine.

Natural speech allows the user to speak commands in phrases or complete sentences. The system filters out certain non-word utterances and sounds such as “ah” and “eh.” The system handles fill-in words such as “I would like to.”

The system handles multiple inputs in the same phrase or sentence such as “make a phone call” and “to Kelly Smith.” For multiple inputs in the same phrase or sentence, the system identifies the topic or context and provides the associated follow-up prompt such as “Who do you want to call?” in the case where a phone call was requested but the specific name was not recognized.



The system utilizes continuous dialog; when the system requires more information from the user it will ask a question to which the user can respond without pressing the Voice Command  button on your steering wheel.

## Voice Command Tree

Refer to “Voice Tree” in this section.



## Help Command

If you need assistance at any prompt, or if you want to know your options at any prompt, say “Help” following the beep.

To activate the Uconnect® Phone from idle, simply press the  button on your steering wheel and say a command or say “help.” All Uconnect® Phone sessions begin with a press of the  button on the radio control head.

## Cancel Command

At any prompt, after the beep, you can say “Cancel” and you will be returned to the main menu.

You can also press the  or  button on your steering wheel when the system is listening for a command and be returned to the main or previous menu.

## Pair (Link) Uconnect® Phone To A Mobile Phone

To begin using your Uconnect® Phone, you must pair your compatible Bluetooth® enabled mobile phone.

### NOTE:

- You must have Bluetooth® enabled on your mobile phone to complete this procedure.
- The vehicle must be in PARK.

To complete the pairing process, you will need to reference your mobile phone Owner’s Manual. The Uconnect® website may also provide detailed instructions for pairing.

1. Touch the “Phone” soft-key on the screen to begin.
2. If there is no phone currently connected with the system, a pop-up will appear.



### Mobile Phone Pairing

3. Select “Yes” to begin the pairing process. Then, search for available devices on your Bluetooth® enabled mobile phone. When prompted on the phone, enter the name and PIN shown on the Uconnect® screen.
  - If “No” is selected, touch the “Settings” soft-key from the Uconnect® Phone main screen.

- Touch the “Add Device” soft-key.
- Search for available devices on your Bluetooth® enabled mobile phone. When prompted on the phone, enter the name and PIN shown on the Uconnect® screen.
- See step 4 to complete the process.

## 170 UNDERSTANDING THE FEATURES OF YOUR VEHICLE

4. Uconnect® Phone will display an in progress screen while the system is connecting.



### Mobile Phone Pairing Progress

5. When the pairing process has successfully completed, the system will prompt you to choose whether or not this is your favorite phone. Selecting “Yes” will make

this phone the highest priority. This phone will take precedence over other paired phones within range.

### Pair Additional Mobile Phones

1. Touch the “Settings” soft-key from the Phone main screen.
2. Touch the “Add Device” soft-key.
3. Search for available devices on your Bluetooth® enabled mobile phone. When prompted on the phone, enter the name and PIN shown on the Uconnect® screen.
4. Uconnect® Phone will display an in process screen while the system is connecting.
5. When the pairing process has successfully completed, the system will prompt you to choose whether or not this is your favorite phone. Selecting “Yes” will make

this phone the highest priority. This phone will take precedence over other paired phones within range.

**NOTE:** For phones which are not made a favorite, the phone priority is determined by the order in which it was paired. The latest phone paired will have the higher priority.

You can also use the following VR commands to bring up the Paired Phone screen from any screen on the radio:

- “Show Paired Phones”
- “Connect My Phone”

### **Pair A Bluetooth® Streaming Audio Device**

1. Touch the “Player” soft-key to begin.
2. Change the Source to Bluetooth®.
3. Touch the “Bluetooth®” soft-key to display the Paired Audio Devices screen.

4. Touch the “Add Device” soft-key.

**NOTE:** If there is no device currently connected with the system, a pop-up will appear.

5. Search for available devices on your Bluetooth® enabled audio device. When prompted on the device, enter the PIN shown on the Uconnect® screen.
6. Uconnect® Phone will display an in process screen while the system is connecting.
7. When the pairing process has successfully completed, the system will prompt you to choose whether or not this is your favorite device. Selecting “Yes” will make this device the highest priority. This device will take precedence over other paired devices within range.

**NOTE:** For devices which are not made a favorite, the device priority is determined by the order in which it was paired. The latest device paired will have the higher priority.

You can also use the following VR command to bring up a list of paired audio devices:

- “Show Paired Phones”
- “Connect My Phone”

### **Connecting To A Particular Mobile Phone Or Audio Device After Pairing**

Uconnect® Phone will automatically connect to the highest priority paired phone and/or Audio Device within range. If you need to choose a particular phone or Audio Device follow these steps:

1. Touch the “Settings” soft-key.
2. Touch the “Paired Phone” or “Paired Audio Source” soft-key.
3. Touch to select the particular Phone or the particular Audio Device.

4. Touch the “X” to exit out of the Settings screen.

### **Disconnecting A Phone Or Audio Device**

1. Touch the “Settings” soft-key.
2. Touch the “Paired Phone” or “Audio Device” soft-key.
3. Touch the “+” soft-key located to the right of the device name.
4. The options pop-up will be displayed.
5. Touch the “Disconnect Device” soft-key.
6. Touch the “X” to exit out of the Settings screen.

### **Deleting A Phone Or Audio Device**

1. Touch the “Settings” soft-key.
2. Touch the “Pair Phone” or “Audio Device” soft-key.

3. Touch the “+” soft-key located to the right of the device name for a different Phone or Audio Device than the currently connected device.
4. The options pop-up will be displayed.
5. Touch the “Delete Device” soft-key.
6. Touch the “X” to exit out of the Settings screen.

### **Making A Phone Or Audio Device A Favorite**

1. Touch the “Settings” soft-key.
2. Touch the “Phone/Bluetooth®” soft-key.
3. Touch the “+” soft-key located to the right of the device name.
4. The options pop-up will be displayed.
5. Touch the “Make Favorite” soft-key; you will see the chosen device move to the top of the list.

6. Touch the “X” to exit out of the Settings screen.

### **Phonebook Download (Automatic Phonebook Transfer From Mobile Phone) — If Equipped**

If equipped and specifically supported by your phone, Uconnect® Phone automatically downloads names (text names) and number entries from the mobile phone’s phonebook. Specific Bluetooth® Phones with Phone Book Access Profile may support this feature. See Uconnect® website, [www.UconnectPhone.com](http://www.UconnectPhone.com), for supported phones.

- To call a name from a downloaded mobile phone book, follow the procedure in the Voice Recognition Quick Reference section.
- Automatic download and update of a phone book, if supported, begins as soon as the Bluetooth® wireless phone connection is made to the Uconnect® Phone, for example, after you start the vehicle.

- A maximum of 1000 entries per phone will be downloaded and updated every time a phone is connected to the Uconnect® Phone.
- Depending on the maximum number of entries downloaded, there may be a short delay before the latest downloaded names can be used. Until then, if available, the previously downloaded phonebook is available for use.
- Only the phonebook of the currently connected mobile phone is accessible.
- This downloaded phonebook cannot be edited or deleted on the Uconnect® Phone. These can only be edited on the mobile phone. The changes are transferred and updated to Uconnect® Phone on the next phone connection.

### Managing Your Favorite Phonebook

There are three ways you can add an entry to your Favorite Phonebook.

1. During an active call of a number to make a favorite, touch and hold a favorite button on the top of the phone main screen.
2. After loading the mobile phonebook, select Phonebook from the Phone main screen, then select the appropriate number. Touch the + next to the selected number to display the options pop-up. In the pop-up select "Add to Favorites."





### Phonebook Favorites

**NOTE:** If the Favorites list is full, you will be asked to remove an existing favorite.

- From the Phone main screen, select Phonebook. From the Phonebook screen, select the “Favorites” soft-key and then select the “+” soft-key located to the right of the phonebook record. Select an empty entry and

touch the + on that selected entry. When the Options pop-up appears, touch “Add from Mobile.” You will then be asked which contact and number to choose from your mobile phonebook. When complete the new favorite will be shown.



### Add From Mobile

### To Remove A Favorite

1. To remove a Favorite, select phonebook from the Phone main screen.
2. Next select Favorites on the left side of the screen and then touch the + Options soft-key.
3. Touch the + next to the Favorite you would like to remove.

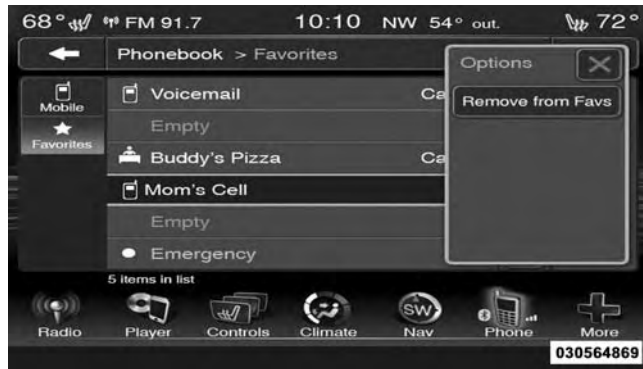

### Remove From Favorites

4. The Options pop-up will display, touch "Remove from Favs."

## Emergency And Towing Assistance

The Emergency and Towing Assistance Favorite numbers can only be altered. These cannot be deleted and the names cannot be changed.

To change the Emergency or Towing Assistance numbers follow these steps.

1. Touch the “Phonebook” soft-key from the Phone main screen.
2. Touch the “Favorites” soft-key. Scroll to the bottom of the list to locate the Emergency and Towing Assistance Favorites.
3. Touch the + Options soft-key.
4. Touch the + next to appropriate Favorite that is to be altered.



0456012195

### Emergency And Breakdown Assistance

5. The Options pop-up will appear and you can choose between Editing the number or resetting the number to default.

## Phone Call Features

The following features can be accessed through the Uconnect® Phone if the feature(s) are available and supported by Bluetooth® on your mobile service plan. For example, if your mobile service plan provides three-way calling, this feature can be accessed through the Uconnect® Phone. Check with your mobile service provider for the features that you have.

### Ways To Initiate A Phone Call

Listed below are all the ways you can initiate a phone call with Uconnect® Phone.

- Redial
- Dial by touching in the number
- Voice Commands (Dial by Saying a Name, Call by Saying a Phonebook Name, Redial, or Call Back)
- Favorites

- Mobile Phonebook
- Recent Call Log
- SMS Message Viewer

### Dial By Saying A Number

1. Press the  button to begin,
2. After the “Listening” prompt and the following beep, say “Dial 151 1234 5555,”
3. The Uconnect® Phone will dial the number 151-1234-5555.

### Call By Saying A Phonebook Name

1. Press the  button on your steering wheel to begin.
2. After the “Listening” prompt and the following beep, say “Call John Doe Mobile.”

3. The Uconnect® Phone will dial the number associated with John Doe, or if there are multiple numbers it will ask which number you want to call for John Doe.

### Call Controls

The touchscreen allows you to control the following call features:

- Answer
- End
- Ignore
- Hold/unhold
- Mute/unmute
- Transfer the call to/from the phone
- Swap two active calls

- Join two active calls together

### Touch-Tone Number Entry

1. Touch the “Phone” soft-key.
2. Touch the “Dial” soft-key.
3. The Touch-Tone screen will be displayed.
4. Use the numbered soft-keys to enter the number and touch “Call.”

To send a touch tone using Voice Recognition (VR), press the  button on your steering wheel while in a call and say “Send 1234#” or you can say “Send Voicemail Password” if Voicemail password is stored in your mobile phonebook.

## Recent Calls

You may browse up to 34 of the most recent of each of the following call types:





### Recent Calls

- Incoming Calls
- Outgoing Calls

- Missed Calls
- All Calls

These can be accessed by touching the “recent calls” soft-key on the Phone main screen.

You can also press the  button and say “Show my incoming calls” from any screen and the Incoming calls will be displayed.

You can also press the  button and say “Show my recent calls” from any screen and the All calls screen will be displayed.

**NOTE:** Incoming can also be replaced with “Outgoing,” “Recent” or “Missed.”

### Answer Or Ignore An Incoming Call — No Call Currently In Progress

When you receive a call on your mobile phone, the Uconnect® Phone will interrupt the vehicle audio system. Press the  button to accept the call. You can also touch the “answer” soft-key or touch the caller ID box.

### Answer Or Ignore An Incoming Call — Call Currently In Progress

If a call is currently in progress and you have another incoming call, you will hear the same network tones for call waiting that you normally hear when using your mobile phone. Press the phone  button, “answer” soft-key or caller ID box to place the current call on hold and answer the incoming call.

**NOTE:** The Uconnect® Phone compatible phones in the market today do not support rejecting an incoming call when another call is in progress. Therefore, the user can only answer an incoming call or ignore it.

### Making A Second Call While Current Call Is In Progress

You can place a call on hold by touching the “Hold” soft-key on the Phone main screen, then dial a number from the dialpad, recent calls, SMS Inbox or from the phonebooks. To go back to the first call, refer to “Toggling Between Calls” in this section. To combine two calls, refer to “Join Calls” in this section.

### Place/Retrieve A Call From Hold

During an active call, touch the “Hold” soft-key on the Phone main screen.

### Toggling Between Calls

If two calls are in progress (one active and one on hold), touch the “Swap” soft-key on the Phone main screen. Only one call can be placed on hold at a time.

You can also press the  button to toggle between the active and held phone call.

## Join Calls

When two calls are in progress (one active and one on hold), touch the “Join Calls” soft-key on the Phone main screen to combine all calls into a Conference Call.

## Call Termination

To end a call in progress, momentarily press the  button or the “end” soft-key. Only the active call(s) will be terminated and if there is a call on hold, it will become the new active call.

## Redial

Press the “Redial” soft-key, or press the  and after the “Listening” prompt and the following beep, say “Redial.”

The Uconnect® Phone will call the last number that was dialed from your mobile phone.

## Call Continuation

Call continuation is the progression of a phone call on the Uconnect® Phone after the vehicle ignition key has been switched to OFF.

**NOTE:** The call will remain within the vehicle audio system until the phone becomes out of range for the Bluetooth® connection. It is recommended to press the “transfer” soft-key when leaving the vehicle.

## Uconnect® Phone Features

### Emergency Assistance

If you are in an emergency and the mobile phone is reachable:

- Pick up the phone and manually dial the emergency number for your area.



If the phone is not reachable and the Uconnect® Phone is operational, you may reach the emergency number as follows:

1. Press the  button to begin.
2. After the “Listening” prompt and the following beep, say “Dial Emergency” and the Uconnect® Phone will instruct the paired mobile phone to call the emergency number. This feature is supported in the U.S., Canada, and Mexico.

**NOTE:**

- The Emergency call may also be initiated by using the touchscreen.
- The emergency number dialed is based on the country where the vehicle is purchased (911 for the U.S. and Canada and 060 for Mexico). The number dialed may not be applicable with the available mobile service and area.

- The Uconnect® Phone does slightly lower your chances of successfully making a phone call as to that for the mobile phone directly.

**WARNING!**

**Your phone must be turned on and connected to the Uconnect® Phone to allow use of this vehicle feature in emergency situations, when the mobile phone has network coverage and stays connected to the Uconnect® Phone.**

**Roadside Assistance / Towing Assistance**

If you need roadside/towing assistance:

1. Press the  button to begin.
2. After the “Listening” prompt and the following beep, say “Roadside Assistance” or say “Towing Assistance.”

**NOTE:** The roadside/towing assistance number dialed is based on the country where the vehicle is purchased (1-800-528-2069 for the U.S., 1-800-363-4869 for Canada, 55-14-3454 for Mexico City and 1-800-712-3040 for outside Mexico City in Mexico). Please refer to the Chrysler Group LLC 24-Hour “Roadside Assistance” coverage details in the Warranty Information Booklet and on the 24-Hour Roadside Assistance Card.

### **Voice Mail Calling**



To learn how to access your voice mail, refer to “Working with Automated Systems”.

### **Working With Automated Systems**

This method is used in instances where one generally has to press numbers on the mobile phone keypad while navigating through an automated telephone system.

You can use your Uconnect® Phone to access a voice mail system or an automated service, such as a paging service

or automated customer service line. Some services require immediate response selection. In some instances, that may be too quick for use of the Uconnect® Phone.

When calling a number with your Uconnect® Phone that normally requires you to enter in a touch-tone sequence on your mobile phone keypad, you can utilize the touchscreen or press the  button and say the word “Send” then the sequence you wish to enter. For example, if required to enter your PIN followed with a pound, (3 7 4 6 #), you can press the  button and say, “Send 3 7 4 6 #.” Saying “Send” followed by a number, or sequence of numbers, is also to be used for navigating through an automated customer service center menu structure, and to leave a number on a pager.



You can also send stored mobile phonebook entries as tones for fast and easy access to voice mail and pager entries. For example, if you previously created a Phonebook entry with First and/or Last Name as “Voicemail

Password”, then if you press the  button and say “Send Voicemail Password” the Uconnect® Phone will then send the corresponding phone number associated with the phonebook entry, as tones over the phone.

#### NOTE:

- The first number encountered for that contact will be sent. All other numbers entered for that contact will be ignored.
- You may not hear all of the tones due to mobile phone network configurations. This is normal.
- Some paging and voice mail systems have system time out settings that are too short and may not allow the use of this feature.
- Pauses, wait or other characters that are supported by some phones are not supported over Bluetooth®. These additional symbols will be ignored in the dialing a numbered sequence.

### Barge In — Overriding Prompts

The  button can be used when you wish to skip part of a prompt and issue your voice command immediately. For example, if a prompt is asking “There are two numbers with the name John. Say the full name” you could press the  button and say, “John Smith” to select that option without having to listen to the rest of the voice prompt.

### Voice Response Length

It is possible for you to choose between Brief and Detailed Voice Response Length.

1. Touch the “More” soft-key (where available), then touch the “Settings” soft-key.
2. Touch the “Display” soft-key, then scroll down to Voice Response Length.

3. Select either “Brief” or “Detailed” by touching the box next to the selection. A check-mark will appear to indicate your selection.

### Phone And Network Status Indicators

Uconnect® Phone will provide notification to inform you of your phone and network status when you are attempting to make a phone call using Uconnect® Phone. The status is given for network signal strength and phone battery strength.

### Dialing Using The Mobile Phone Keypad

#### **WARNING!**

**Driving while distracted can result in loss of vehicle control, accident and injury. Chrysler Group LLC strongly recommends that you use extreme caution when using any device or feature that may take your focus off the road. Your primary responsibility is the safe operation of your vehicle. We recommend against the use of any handheld device while driving, encourage the use of voice-operated systems when possible and that you become aware of applicable laws that may affect the use of electronic devices while driving.**

You can dial a phone number with your mobile phone keypad and still use the Uconnect® Phone (while dialing via the mobile phone keypad, the user must exercise caution and take precautionary safety measures). By

dialing a number with your connected Bluetooth® mobile phone, the audio will be played through your vehicle's audio system. The Uconnect® Phone will work the same as if you dial the number using voice a command.

**NOTE:** Certain brands of mobile phones do not send the dial ring to the Uconnect® Phone to play it on the vehicle audio system, so you will not hear it. Under this situation, after successfully dialing a number the user may feel that the call did not go through even though the call is in progress. Once your call is answered, you will hear the audio.

### **Mute/Un-Mute (Mute ON/OFF)**

When you mute the Uconnect® Phone, you will still be able to hear the conversation coming from the other party, but the other party will not be able to hear you. To mute the Uconnect® Phone simply touch the "Mute" button on the Phone main screen.

## **Advanced Phone Connectivity**

### **Transfer Call To And From Mobile Phone**

The Uconnect® Phone allows ongoing calls to be transferred from your mobile phone to the Uconnect® Phone without terminating the call. To transfer an ongoing call from your connected mobile phone to the Uconnect® Phone or vice versa, press the "Transfer" button on the Phone main screen.

### **Connect Or Disconnect Link Between The Uconnect® Phone And Mobile Phone**

If you would like to connect or disconnect the Bluetooth® connection between a Uconnect® Phone paired mobile phone and the Uconnect® Phone, follow the instructions described in your mobile phone User's Manual.

## Things You Should Know About Your Uconnect® Phone

### Voice Command

- For best performance, adjust the rearview mirror to provide at least ½ in (1 cm) gap between the overhead console (if equipped) and the mirror.
- Always wait for the beep before speaking.
- Speak normally, without pausing, just as you would speak to a person sitting a few feet/meters away from you.
- Ensure that no one other than you is speaking during a voice command period.

Performance is maximized under:

- Low-To-Medium Blower Setting
- Low-To-Medium Vehicle Speed

- Low Road Noise
- Smooth Road Surface
- Fully Closed Windows
- Dry Weather Condition

Even though the system is designed for many languages and accents, the system may not always work for some. When navigating through an automated system such as voice mail, or when sending a page, before speaking the digit string, make sure to say “Send.”

**NOTE:** It is recommended that you do not store names in your favorites phonebook while the vehicle is in motion.

Phonebook (Mobile and Favorites) name recognition rate is optimized when the entries are not similar. You can say “O” (letter “O”) for “0” (zero).

Even though international dialing for most number combinations is supported, some shortcut dialing number combinations may not be supported.

### **Far End Audio Performance**

Audio quality is maximized under:

- Low-To-Medium Blower Setting
- Low-To-Medium Vehicle Speed
- Low Road Noise
- Smooth Road Surface
- Fully Closed Windows
- Dry Weather Conditions
- Operation From The Driver's Seat

Performance such as audio clarity, echo, and loudness to a large degree rely on the phone and network, and not the Uconnect® Phone.

Echo at the far end can sometimes be reduced by lowering the in-vehicle audio volume.

In a convertible vehicle, system performance may be compromised with the convertible top down.

### **Voice Text Reply**

Uconnect® Phone can read or send new messages on your phone.

## 190 UNDERSTANDING THE FEATURES OF YOUR VEHICLE

Your phone must support SMS over Bluetooth® to use this feature. If the Uconnect® Phone determines your phone is not compatible with SMS messaging over Bluetooth® the “Messaging” button will be grayed out and the feature will not be available for use.



Voice Text List

**NOTE:** Uconnect® Phone SMS is only available when the vehicle is not moving.

## Read Messages:

If you receive a new text message while your phone is connected to Uconnect® Phone, an announcement will be made to notify you that you have a new text message.



Voice Text Reply



Once a message is received and viewed or listened to, you will have the following options:

- Send a Reply
- Forward
- Call

### Send Messages Using Soft-Keys:

You can send messages using Uconnect® Phone. To send a new message:

1. Touch the “Phone” soft-key.
2. Touch the “messaging” soft-key then “New Message.”
3. Touch one of the 18 preset messages and the person you wish to send the message to.



### Preset Message List

4. If multiple numbers are available for the contact select which number you would like to have the message sent.
5. Press “Send” or “Cancel.”

### Send Messages Using Voice Commands:

1. Press the  button.
2. After the “Listening” prompt and the following beep, say “Send message to John Smith mobile.”
3. After the system prompts you for what message you want to send, say the message you wish to send or say “List.” There are 18 preset messages.

While the list of defined messages are being read, you can interrupt the system by pressing the  button and saying the message you want to send.

After the system confirms that you want to send your message to John Smith, your message will be sent.



#### Preset Message List

List of Preset Messages:

1. Yes.
2. No.
3. Okay.

4. I can't talk right now.
5. Call me.
6. I'll call you later.
7. I'm on my way.
8. Thanks.
9. I'll be late.
10. I will be <number> minutes late.
11. See you in <number> minutes.
12. Stuck in traffic.
13. Start without me.
14. Where are you?
15. Are you there yet?
16. I need directions.

17. I'm lost.
18. See you later.

### **Bluetooth® Communication Link**

Mobile phones have been found to lose connection to the Uconnect® Phone. When this happens, the connection can generally be reestablished by switching the mobile phone OFF/ON. Your mobile phone is recommended to remain in Bluetooth® ON mode.

### **Power-Up**

After switching the ignition key from OFF to either the ON or ACC position, or after a language change, you must wait at least 15 seconds prior to using the system.

## Voice Tree

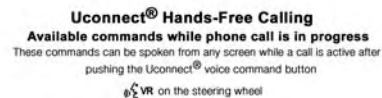
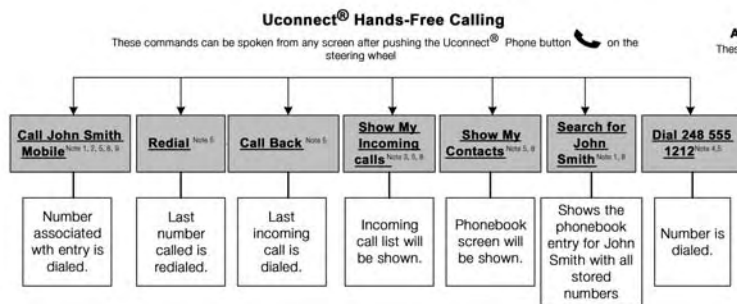

**NOTE:**

1. You can replace “John Smith” with any name in your mobile or favorite phone book. You can also say “Send a message to John Smith” and the system will ask you which phone number you want to send a message to for John Smith.
2. You can replace “Mobile” with “Home,” “Work” or “Other.”
3. You can replace “Incoming Calls” with “Outgoing Calls” or “Missed Calls.”
4. You can replace “248 555 1212” with any phone number supported by your Mobile phone.
5. These commands can be used during a phone call after pushing the Uconnect® Voice Command button on the steering wheel. Please note the call will be muted while the VR session is active.
6. Send dial tones for automated systems is available while a call is active. This is an example that uses a Phonebook Record named “Voicemail Password.”
7. Storing Dial tones in contact names is possible but only the first number encountered in a contact name will be sent. For example if there is a number stored in the Home and Work numbers for the contact “Voice-mail password” only the Home number will be sent.
8. If your phone does not support phonebook download or call log download over Bluetooth® then these commands will return a response that the contact does not exist in the phonebook.
9. Emergency and Towing assistance are contacts that have been pre-loaded in the phonebook. Commands such as “Call Emergency” and “Call Towing Assistance” will call the corresponding number stored with those contacts.

**NOTE:** Available Voice Commands are shown in bold face and underlined in the gray shaded boxes.

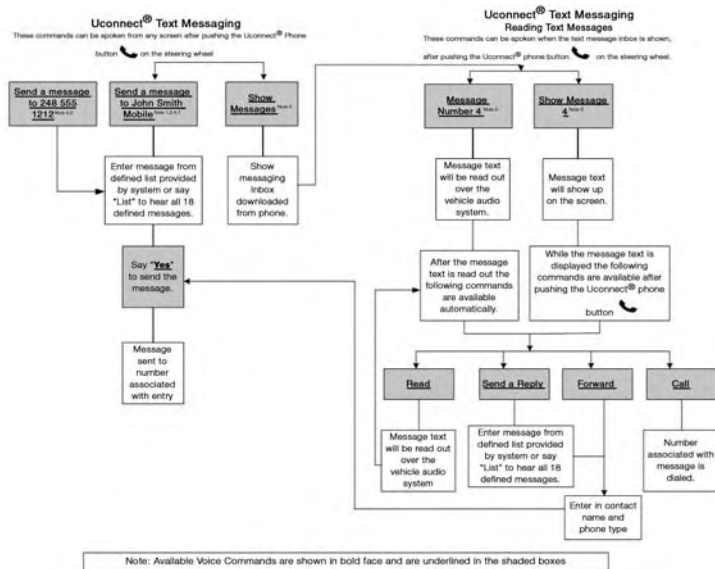

**NOTE:**

1. You can replace “John Smith” with any name in your mobile or favorite phone book. You can also say “Send a message to John Smith” and the system will ask you which phone number you want to send a message to for John Smith.
2. You can replace “Mobile” with “Home,” “Work” or “Other.”
3. You can replace “Incoming Calls” with “Outgoing Calls” or “Missed Calls.”
4. Messaging commands only work if the Uconnect® system is equipped with this feature and the mobile phone supports messaging over Bluetooth®.
5. You can replace “248 555 1212” with any phone number supported by your Mobile phone.
6. You can replace “4” with any message number shown on the screen.
7. If your phone does not support phonebook download or call log download over Bluetooth® then these commands will return a response that the contact does not exist in the phonebook.

## Uconnect® Hands-Free Calling Universal & Connect Commands

These commands can be spoken from any screen after pushing the Uconnect® Phone button



on the steering wheel

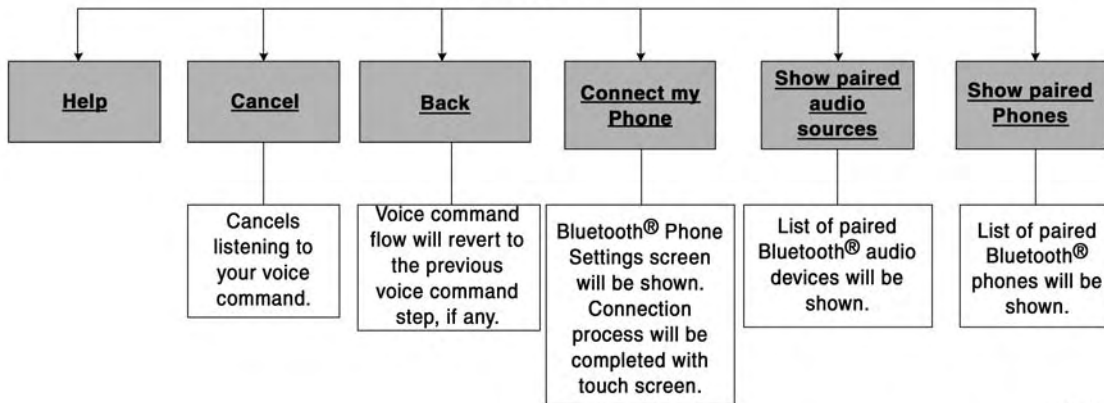



**NOTE:** Available Voice Commands are shown in bold face and underlined in the gray shaded boxes.

### General Information

This device complies with Part 15 of the FCC rules and RSS 210 of Industry Canada. Operation is subject to the following conditions:

- Changes or modifications not expressly approved by the party responsible for compliance could void the user's authority to operate the equipment.
- This device may not cause harmful interference.
- This device must accept any interference received, including interference that may cause undesired operation.

## VOICE COMMAND (Uconnect® 200)

### Voice Command System Operation



This Voice Command system allows you to control your AM, FM radio, satellite radio, disc player, and a memo recorder.

**NOTE:** Take care to speak into the Voice Interface System as calmly and normally as possible. The ability of the Voice Interface System to recognize user voice commands may be negatively affected by rapid speaking or a raised voice level.

**WARNING!**

**Any voice commanded system should be used only in safe driving conditions following all applicable laws, including laws regarding phone use. Your attention should be focused on safely operating the vehicle. Failure to do so may result in a collision causing serious injury or death.**

When you press the Voice Command  button, you will hear a beep. The beep is your signal to give a command.

**NOTE:** If you do not say a command within a few seconds, the system will present you with a list of options.

If you ever wish to interrupt the system while it lists options, press the Voice Command  button, listen for the beep, and say your command.

Pressing the Voice Command  button while the system is speaking is known as “barging in.” The system will be interrupted, and after the beep, you can add or change commands. This will become helpful once you start to learn the options.

**NOTE:** At any time, you can say the words “Cancel”, “Help” or “Main Menu”.

These commands are universal and can be used from any menu. All other commands can be used depending upon the active application.

When using this system, you should speak clearly and at a normal speaking volume.

The system will best recognize your speech if the windows are closed, and the heater/air conditioning fan is set to low.

At any point, if the system does not recognize one of your commands, you will be prompted to repeat it.

To hear the first available Menu, press the Voice Command  button and say “Help” or “Main Menu”.

### Commands

The Voice Command system understands two types of commands, Universal commands and Local commands. Universal commands are available at all times. Local commands are available if the supported radio mode is active.

### Changing The Volume

1. Start a dialogue by pressing the Voice Command  button.
2. Say a command (e.g., “Help”).
3. Use the ON/OFF VOLUME rotary knob to adjust the volume to a comfortable level while the Voice Command system is speaking. Please note the volume setting for Voice Command is different than the audio system.

### Main Menu

Start a dialogue by pressing the Voice Command  button. You may say “Main Menu” to switch to the main menu.

In this mode, you can say the following commands:

- “Radio AM” (to switch to the radio AM mode)
- “Radio FM” (to switch to radio FM mode)
- “Sat” (to switch to Satellite radio mode)
- “Disc” (to switch to the disc mode)
- “USB” (to switch to USB mode)
- “Bluetooth Streaming” (to switch to Bluetooth® Streaming mode)
- “Memo” (to switch to the memo recorder)
- “System Setup” (to switch to system setup)

## Radio AM

To switch to the AM band, say “AM” or “Radio AM.” In this mode, you may say the following commands:

- “Frequency #” (to change the frequency)
- “Next Station” (to select the next station)
- “Previous Station” (to select the previous station)
- “Radio Menu” (to switch to the radio menu)
- “Main Menu” (to switch to the main menu)

## Radio FM

To switch to the FM band, say “FM” or “Radio FM.” In this mode, you may say the following commands:

- “Frequency #” (to change the frequency)
- “Next Station” (to select the next station)
- “Previous Station” (to select the previous station)

- “Menu Radio” (to switch to the radio menu)
- “Main Menu” (to switch to the main menu)

## Satellite Radio

To switch to satellite radio mode, say “Sat” or “Satellite Radio.” In this mode, you may say the following commands:

- “Channel Number” (to change the channel by its spoken number)
- “Next Channel” (to select the next channel)
- “Previous Channel” (to select the previous channel)
- “List Channel” (to hear a list of available channels)
- “Select Name” (to say the name of a channel)
- “Menu Radio” (to switch to the radio menu)
- “Main Menu” (to switch to the main menu)

## Disc Mode

To switch to the disc mode, say “Disc.” In this mode, you may say the following commands:

- “Track” (#) (to change the track)
- “Next Track” (to play the next track)
- “Previous Track” (to play the previous track)
- “Main Menu” (to switch to the main menu)

## USB Mode

To switch to USB mode, say “USB.” In this mode, you may say the following commands:

- “Next Track” (to play the next track)
- “Previous Track” (to play the previous track)
- “Play” (to play an Artist Name, Playlist Name, Album Name, Track Name, etc.)

## Bluetooth® Streaming (BT) Mode

To switch to Bluetooth® Streaming (BT) mode, say “Bluetooth Streaming.” In this mode, you may say the following commands:

- “Next Track” (to play the next track)
- “Previous Track” (to play the previous track)
- “List” (to list an Artist, Playlist, Album, Track, etc.)

## Memo Mode

To switch to the voice recorder mode, say “Memo.” In this mode, you may say the following commands:

- “New Memo” (to record a new memo) — During the recording, you may press the Voice Command  button to stop recording. You proceed by saying one of the following commands:
  - “Save” (to save the memo)

- “Continue” (to continue recording)
- “Delete” (to delete the recording)
- “Play Memos” (to play previously recorded memos) — During the playback you may press the Voice Command  button to stop playing memos. You proceed by saying one of the following commands:
  - “Repeat” (to repeat a memo)
  - “Next” (to play the next memo)
  - “Previous” (to play the previous memo)
  - “Delete” (to delete a memo)
  - “Delete All” (to delete all memos)

## Setup

To switch to system setup, you may say one of the following:

- “Change to setup”
- “Switch to system setup”
- “Main menu setup”
- “Switch to setup”

In this mode, you may say the following commands:

- “Language English”
- “Language French”
- “Language Spanish”
- “Tutorial”
- “Voice Training”

**NOTE:** Keep in mind that you have to press the Voice Command  button first and wait for the beep before speaking the “Barge In” commands.

### Voice Training

For users experiencing difficulty with the system recognizing their voice commands or numbers the Uconnect® Voice “Voice Training” feature may be used.

1. Press the Voice Command  button, say “System Setup” and once you are in that menu then say “Voice Training.” This will train your own voice to the system and will improve recognition.
2. Repeat the words and phrases when prompted by Uconnect® Voice. For best results, the “Voice Training” session should be completed when the vehicle is parked, engine running, all windows closed, and the blower fan switched off. This procedure may be repeated with a new user. The system will adapt to the last trained voice only.

## VOICE COMMAND

### Uconnect® 8.4/8.4 Nav

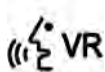

The Uconnect® Voice Command system allows you to control your AM, FM radio, satellite radio, disc player, SD Card, USB/iPod® and SiriusXM Travel Link.

**NOTE:** Take care to speak into the Voice Command system as calmly and normally as possible. The ability of the Voice Command system to recognize user voice commands may be negatively affected by rapid speaking or a raised voice level.

### WARNING!

**Any voice commanded system should be used only in safe driving conditions following all applicable laws, including laws regarding phone use. Your attention should be focused on safely operating the vehicle. Failure to do so may result in a collision causing serious injury or death.**

When you press the Uconnect® Voice Command  button, you will hear a beep. The beep is your signal to give a command.



If no command is spoken the system will say one of two responses:

- I didn't understand
- I didn't get that, etc.

If a command is not spoken a second time, the system will respond with an error and give some direction as what can be said based on the context you are in. After three consecutive failures of a spoken command the VR session will end.

Pressing the Uconnect® Voice Command  button while the system is speaking is known as “barging in.” The system will be interrupted, and after the beep, you can say a command. This will become helpful once you start to learn the options.

**NOTE:** At any time, you can say the words “Cancel” or “Help.”

These commands are universal and can be used from any menu. All other commands can be used depending upon the active application.

When using this system, you should speak clearly and at a normal speaking volume.

The system will best recognize your speech if the windows are closed, and the heater/air conditioning fan is set to low.

At any point, if the system does not recognize one of your commands, you will be prompted to repeat it.

To hear available commands, press the Uconnect® Voice Command  button and say "Help." You will hear available commands for the screen displayed.

## Uconnect® Voice Commands

The Uconnect® Voice Command system understands two types of commands. Universal commands are available at all times. Local commands are available if the supported radio mode is active.

Start a dialogue by pressing the Uconnect® Voice Command  button.

### Changing The Volume

1. Start a dialogue by pressing the Voice Command  button.
2. Say a command (e.g., “Help”).
3. Use the ON/OFF VOLUME rotary knob to adjust the volume to a comfortable level while the Voice Command system is speaking. Please note the volume setting for Voice Command is different than the audio system.

## Starting Voice Recognition (VR) Session In Radio/Player Modes

In this mode, you can say the following commands:

**NOTE:** The commands can be said on any screen when a call is not active after pushing the Uconnect® Voice Command  button.

### Source

To switch to the audio source, say “Change source to Disc” for example. This command can be given in any mode or screen:

- “Track” (#) (to change the track)

## Voice Tree

### Uconnect® Voice Command AM/FM/Satellite Radio available commands

These commands can be spoken when the AM, FM or Satellite radio is playing,  
after pushing the Uconnect® voice command button  VR on the steering wheel.

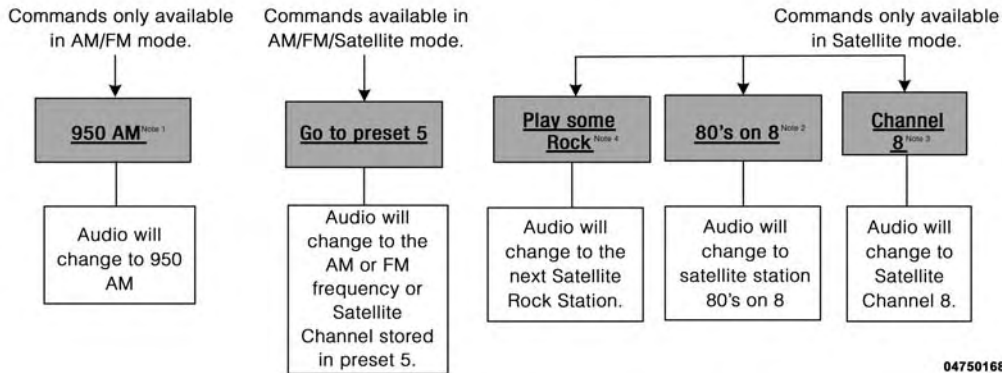

**NOTE:**

1. You can replace “950 AM” with any other AM or FM frequency, such as “98.7 FM.”
2. You can replace “80’s on 8” with any other satellite station name received by the radio.
3. You can replace “8” with any other satellite channel number received by the radio.
4. You can replace “rock” with any of the satellite music types.

**NOTE:** Available Voice Commands are shown in bold face and shaded grey.

## Uconnect® Hands-Free Music Control

These commands can be spoken when playing music from your SD card, USB device, CD or iPod, after pushing the Uconnect® voice commands button  on the steering wheel.

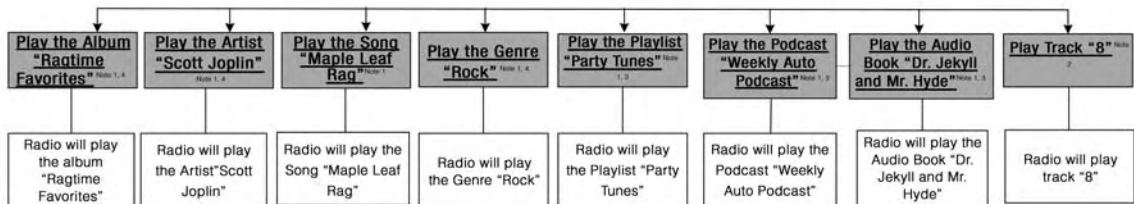

**NOTE:**

1. You can replace the album, artist, song, genre, playlist, podcast and audio book names with any corresponding names on the current device that is playing.
2. You can replace “8” with any track on the CD that is currently playing. Command is only available when CD is playing.

3. Playlist, Podcast and audio book commands are only available when the iPod® is connected and playing.
4. VR commands, Albums, Artists, and Genre names are based on the music metadata contained on the loaded/connected device.

**NOTE:** Available Voice Commands are shown in bold face and shaded grey.

## Uconnect® Voice Command Travel Link commands

These commands can be said on any screen when a call is not active

after pushing the Uconnect® voice command button  VR on the steering wheel.

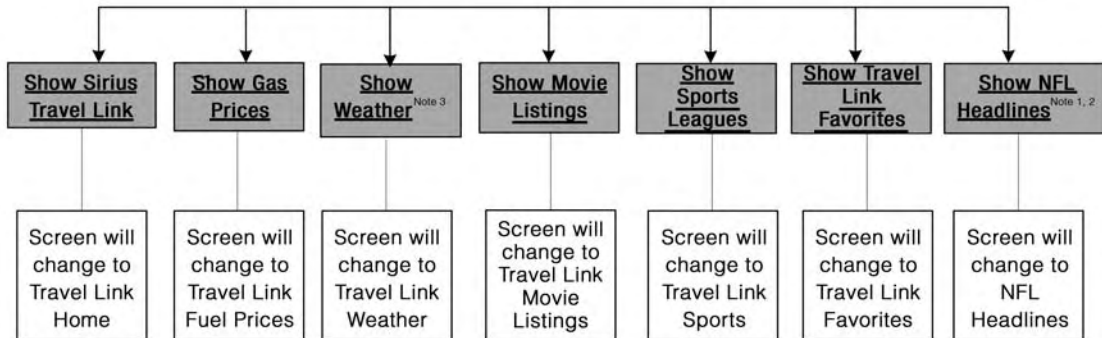



**NOTE:**

1. You can replace “NFL” with any league shown on the sports league screen. For example you can say “Show MLB headlines” or “Show PGA headlines.”
2. You can replace “Headlines” with any menu items shown on a league screen. For example you can say “Show NFL Schedule and results” or “Show NCAA Basketball AP top 25” or “Show Major League Baseball Teams.”

3. You can also say “Show Current Weather” or “Show extended weather” or “Show five day forecast” or “Show ski info” to get other forecasts.

**NOTE:** Available Voice Commands are shown in bold face and shaded grey.

## Uconnect® Voice Command Non-phone - Universal & Mode Commands

These commands can be spoken on any screen when not on a phone call,

after pushing the Uconnect® voice command button  on the steering wheel.

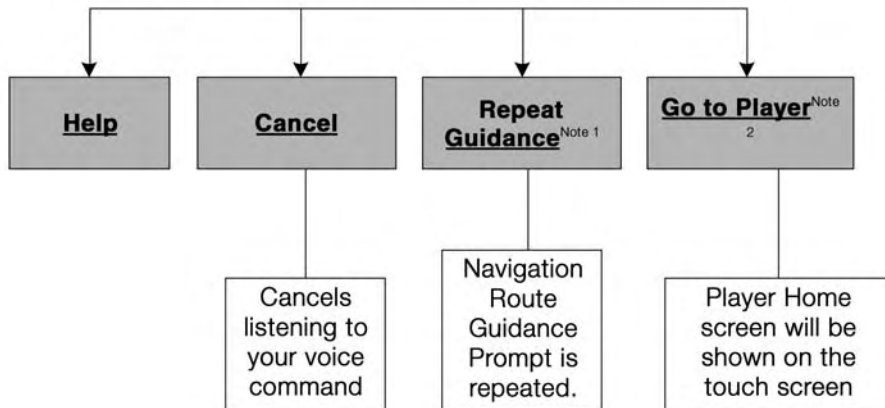

**NOTE:**

1. Only available with Navigation equipped vehicles.
2. You can replace “Player” with “Radio,” “Navigation,” “Phone,” “Climate,” “More” or “Settings.”

3. Navigation commands only work if equipped with Navigation.

**NOTE:** Available Voice Commands are shown in bold face and shaded grey.

### Uconnect® Voice Command Navigation Universal Commands

These commands can be spoken on any screen when not on a phone call.

after pushing the Uconnect® voice command button  VR on the steering wheel.

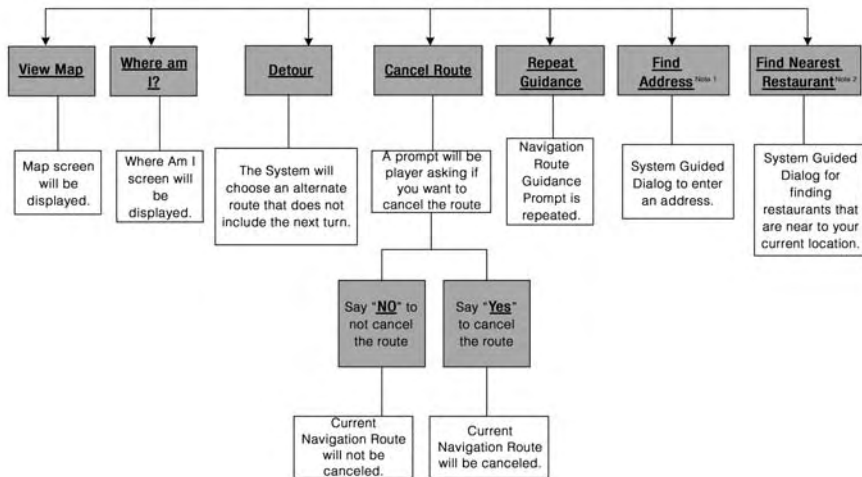

**NOTE:**

1. You can also say "Find City," "Find Favorite," "Find Play by Category," "Find Play by Name," "Find Recently Found," "Where to?" or "Go Home."
2. You can say "Find Nearest" then "Restaurant," "Fuel," "Transit," "Lodging," "Shopping," "Bank," "Entertainment," "Recreation," "Attractions," "Community," "Auto Services," "Hospitals," "Parking," "Airport," "Police Stations," "Fire Stations," or "Auto Dealers."

**NOTE:** Available Voice Commands are shown in bold face and shaded grey.

**SEATS**

Seats are a part of the Occupant Restraint System of the vehicle.

**WARNING!**

- It is dangerous to ride in a cargo area, inside or outside of a vehicle. In a collision, people riding in these areas are more likely to be seriously injured or killed.
- Do not allow people to ride in any area of your vehicle that is not equipped with seats and seat belts. In a collision, people riding in these areas are more likely to be seriously injured or killed.
- Be sure everyone in your vehicle is in a seat and using a seat belt properly.

## Power Seats — If Equipped

Some models may be equipped with a power driver's seat. The power seat switch is located on the outboard side of the seat near the floor. Use the switch to move the seat up, down, forward or rearward.

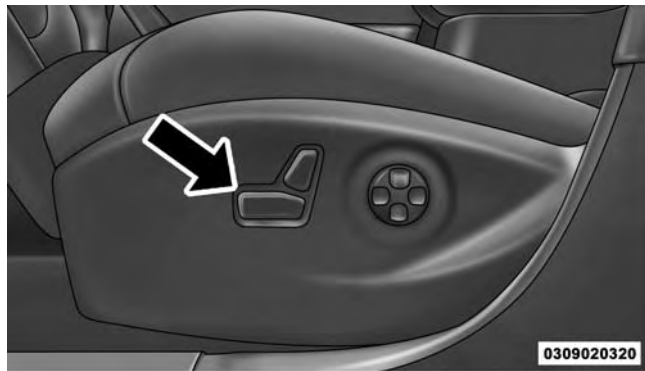

Power Seat Switch

## Adjusting The Seat Forward Or Rearward

The seat can be adjusted both forward and rearward. Push the seat switch forward or rearward, the seat will move in the direction of the switch. Release the switch when the desired position has been reached.

## Adjusting The Seat Up Or Down

The height of the seats can be adjusted up or down. Pull upward or push downward on the seat switch, the seat will move in the direction of the switch. Release the switch when the desired position is reached.

## Reclining The Seatback Forward Or Rearward

The seatback can be reclined both forward and rearward. Push the seat recliner switch forward or rearward, the seatback will move in the direction of the switch. Release the switch when the desired position has been reached.

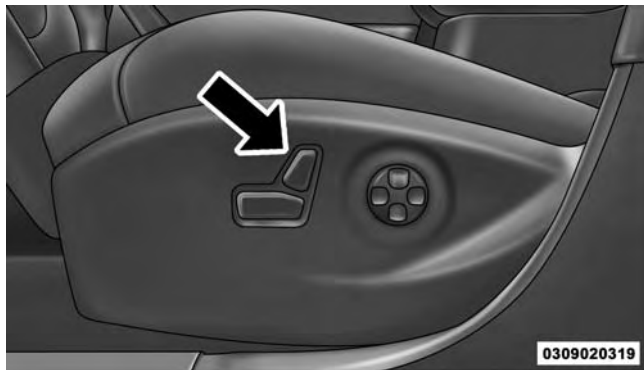

Power Seat Recliner Switch

### WARNING!

**Do not ride with the seatback reclined so that the shoulder belt is no longer resting against your chest. In a collision you could slide under the seat belt, which could result in serious injury or death.**

### Power Lumbar — If Equipped

Vehicles equipped with power driver or passenger seats may also be equipped with power lumbar. The power lumbar switch is located on the outboard side of the power seat. Push the switch forward or rearward to increase or decrease the lumbar support. Push the switch upward or downward to raise or lower the lumbar support.



Power Lumbar Switch

### Manual Front Seat Forward/Rearward Adjustment

On models equipped with manual seats, the adjusting bar is located at the front of the seats, near the floor.



### Front Seat Adjustment

While sitting in the seat, lift up on the bar and move the seat forward or rearward. Release the bar once you have reached the desired position. Then, using body pressure,



move forward and rearward on the seat to be sure that the seat adjusters have latched.

### WARNING!

- Adjusting a seat while driving may be dangerous. Moving a seat while driving could result in loss of control which could cause a collision and serious injury or death.
- Seats should be adjusted before fastening the seat belts and while the vehicle is parked. Serious injury or death could result from a poorly adjusted seat belt.

### Manual Front Seat Recline Adjustment

To adjust the seatback, lift the lever located on the outboard side of the seat, lean back to the desired position and release the lever. To return the seatback, lift the lever, lean forward and release the lever.



Recline Lever

### WARNING!

Do not ride with the seatback reclined so that the shoulder belt is no longer resting against your chest. In a collision you could slide under the seat belt, which could result in serious injury or death.

### Manual Seat Height Adjustment — If Equipped

The driver's seat height can be raised or lowered by using a lever, located on the outboard side of the seat. Pull upward on the lever to raise the seat height or push downward on the lever to lower the seat height.

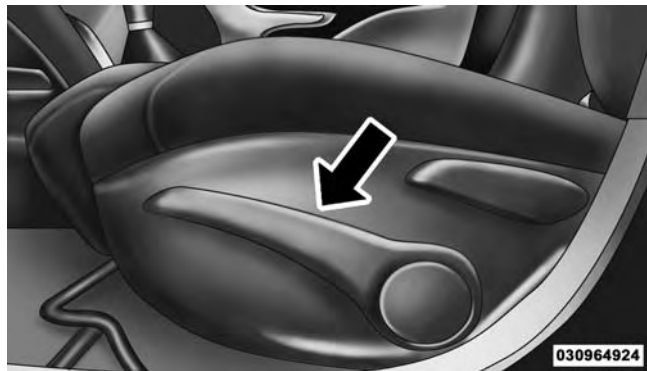

Seat Height Adjustment

### Heated Seats — If Equipped

On some models, the front seats may be equipped with heaters in both the seat cushions and seatbacks.

The front driver and passenger heated seats are operated using the Uconnect® System.

#### WARNING!

- Persons who are unable to feel pain to the skin because of advanced age, chronic illness, diabetes, spinal cord injury, medication, alcohol use, exhaustion or other physical condition must exercise care when using the seat heater. It may cause burns even at low temperatures, especially if used for long periods of time.

*(Continued)*

**WARNING! (Continued)**

- Do not place anything on the seat or seatback that insulates against heat, such as a blanket or cushion. This may cause the seat heater to overheat. Sitting in a seat that has been overheated could cause serious burns due to the increased surface temperature of the seat.

### Front Heated Seat Operations — Vehicles Equipped With Uconnect® 8.4 and 8.4N:

Press the “Controls” soft-key located on the Uconnect® display.



Controls Soft-Key



Press the “Driver” or “Passenger” seat soft-key once to select HI-level heating. Press the soft-key a second time to select LO-level heating. Press the soft-key a third time to shut the heating elements OFF.



Heated Seats Soft-Keys

**NOTE:** Once a heat setting is selected, heat will be felt within two to five minutes.

When the HI-level setting is selected, the heater will provide a boosted heat level during the first four minutes of operation. Then, the heat output will drop to the normal HI-level. If the HI-level setting is selected, the system will automatically switch to LO-level after approximately 60 minutes of continuous operation. At that time, the display will change from HI to LO, indicating the change. The LO-level setting will turn OFF automatically after approximately 45 minutes.

### Vehicle Equipped With Remote Start

On models that are equipped with remote start, the driver’s heated seat can be programmed to come on during a remote start. Refer to “Auto-On Comfort & Remote Start” in “Understanding Your Instrument Panel” for further information.

## Head Restraints

Head restraints are designed to reduce the risk of injury by restricting head movement in the event of a rear impact. Head restraints should be adjusted so that the top of the head restraint is located above the top of your ear.

### WARNING!

**The head restraints for all occupants must be properly adjusted prior to operating the vehicle or occupying a seat. Head restraints should never be adjusted while the vehicle is in motion. Driving a vehicle with the head restraints improperly adjusted or removed could cause serious injury or death in the event of a collision.**

## Active Head Restraints — Front Seats

The front driver and passenger seats are equipped with Active Head Restraints (AHR). In the event of a rear impact the AHRs will automatically extend forward minimizing the gap between the back of the occupants head and the AHR.

The AHRs will automatically return to their normal position following a rear impact. If the AHRs do not return to their normal position see your authorized dealer immediately.

To raise the head restraint, pull upward on the head restraint. To lower the head restraint, press the push button, located at the base of the head restraint, and push downward on the head restraint.

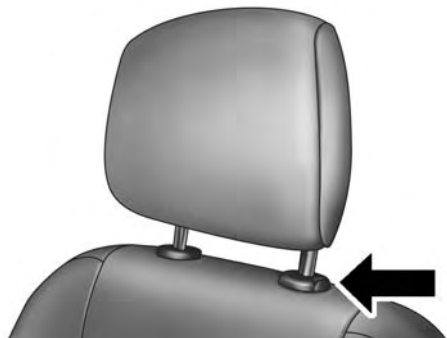

030907490

Push Button

**NOTE:** The head restraints should only be removed by qualified technicians, for service purposes only. If either of the head restraints require removal, see your authorized dealer.

**WARNING!**

Do not place items over the top of the Active Head Restraint, such as coats, seat covers or portable DVD players. These items may interfere with the operation of the Active Head Restraint in the event of a collision and could result in serious injury or death.

## Rear Head Restraints

The rear outboard head restraints have three positions UP, MID and DOWN. The center head restraint has only two positions, Up and Down. When the center seat is being occupied the head restraint should be in the raised position. When there are no occupants in the center seat the head restraint can be lowered for maximum visibility for the driver.

To raise the head restraint, pull upward on the head restraint. To lower the head restraint, press the push button, located at the base of the head restraint, and push downward on the head restraint.



Push Button

## Folding Rear Seat

The rear seatbacks can be folded forward to provide an additional storage area. To fold the rear seatback, pull on the loops located on the upper seatback.

**NOTE:** The upper seatback loops can be tucked away when not in use.

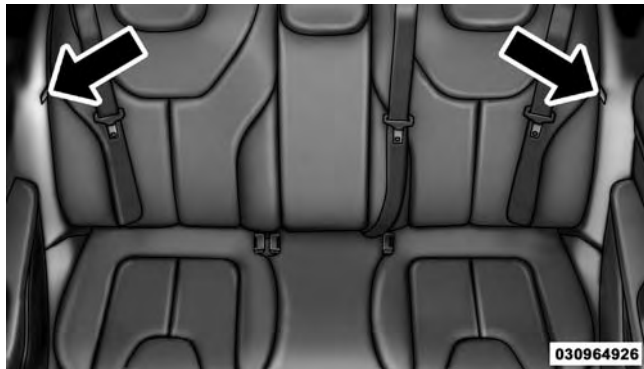

**Rear Seatback Loops**

After releasing the seatback, it can be folded forward.



**Folded Rear Seatback**

When the seatback is folded to the upright position, make sure it is latched by strongly pulling on the top of the seatback above the seat strap.



**WARNING!**

- Be certain that the seatback is securely locked into position. If the seatback is not securely locked into position, the seat will not provide the proper stability for child seats and/or passengers. An improperly latched seat could cause serious injury.
- The cargo area in the rear of the vehicle (with the rear seatbacks in the locked-up or folded down position) should not be used as a play area by children when the vehicle is in motion. They could be seriously injured in a collision. Children should be seated and using the proper restraint system.

**TO OPEN AND CLOSE THE HOOD**

Two latches must be released to open the hood.

1. Pull the hood release lever located under the left side of the instrument panel.

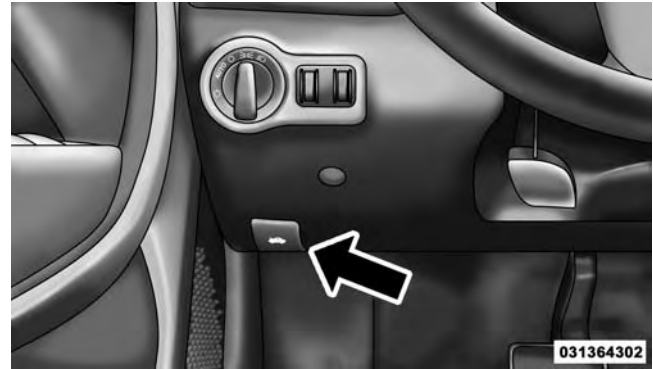
**3**

Hood Release Lever

232 UNDERSTANDING THE FEATURES OF YOUR VEHICLE

2. Move to the outside of the vehicle and push the safety catch to the left. The safety catch is located under the center front edge of the hood.
3. Lift upward on the hood prop rod to release it from the stowage retainer.



060635505

Hood Safety Latch

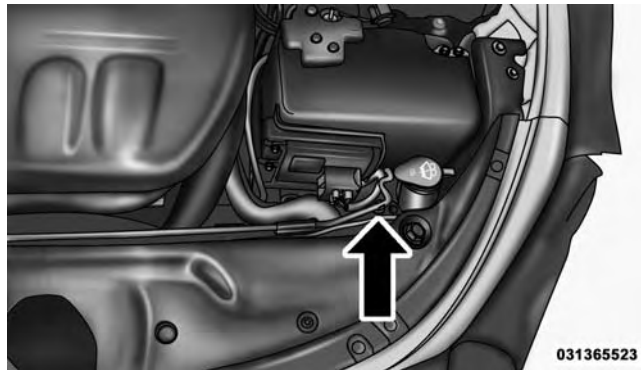

031365523

Hood Prop Rod

- Place the hood prop rod in the hood slot to secure the hood in the open position.

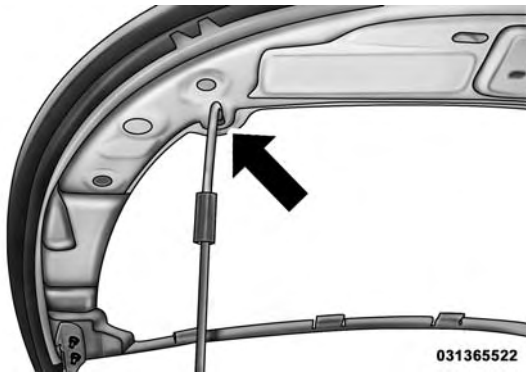

Hood Prop Rod Slot

031365522

### CAUTION!

To prevent possible damage, do not slam the hood to close it. Lower the hood until it is open approximately 6 in (15 cm), and then drop it. This should secure both latches. Never drive your vehicle unless the hood is fully closed, with both latches engaged.

### WARNING!

Be sure the hood is fully latched before driving your vehicle. If the hood is not fully latched, it could open when the vehicle is in motion and block your vision. Failure to follow this warning could result in serious injury or death.

## LIGHTS

### Headlight Switch



The headlight switch is located on the left side of the instrument panel. This switch controls the operation of the headlights, parking lights, instrument panel lights, instrument panel light dimming, interior lights and fog lights.

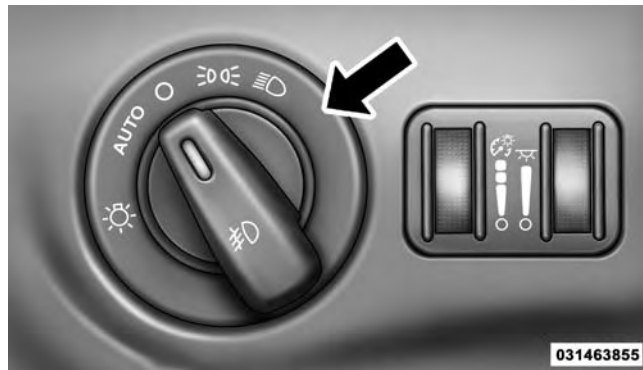

### Headlight Switch

Rotate the headlight switch clockwise to the first detent for parking light and instrument panel light operation. Rotate the headlight switch to the second detent for headlight, parking light and instrument panel light operation.

### **Automatic Headlights — If Equipped**

This system automatically turns the headlights on or off according to ambient light levels. To turn the system on, rotate the headlight switch counterclockwise to the AUTO position. When the system is on, the headlight time delay feature is also on. This means the headlights will stay on for up to 90 seconds after you place the ignition into the OFF position. To turn the automatic system off, move the headlight switch out of the AUTO position.

**NOTE:** The engine must be running before the headlights will come on in the automatic mode.

### **Headlights On With Wipers (Available With Automatic Headlights Only)**

When this feature is active, the headlights will turn on approximately 10 seconds after the wipers are turned on if the headlight switch is placed in the AUTO position. In

addition, the headlights will turn off when the wipers are turned off if they were turned on by this feature.

**NOTE:** The Headlights On with Wipers feature can be turned on or off using the Uconnect® System, refer to “Uconnect® Settings” in “Understanding Your Instrument Panel” for further information.

### **Headlight Time Delay**

This feature provides the safety of headlight illumination for up to 90 seconds (programmable) when leaving your vehicle in an unlit area.

To activate the delay feature, place the ignition in the OFF position while the headlights are still on. Then, turn off the headlights within 45 seconds. The delay interval begins when the headlight switch is turned off.

If you turn the headlights or parking lights on, or place the ignition in ACC or RUN, the system will cancel the delay.

If you turn the headlights off before the ignition, they will turn off in the normal manner.

**NOTE:**

- The lights must be turned off within 45 seconds of placing the ignition in the OFF position to activate this feature.
- The headlight delay time is programmable using the Uconnect® System, refer to “Uconnect® Settings” in “Understanding Your Instrument Panel” for further information.

**Automatic High Beam Headlamp Control — If Equipped**

The Automatic High Beam Headlamp Control system provides increased forward lighting at night by automating high beam control through the use of a digital camera mounted on the inside rearview mirror. This camera

detects vehicle specific light and automatically switches from high beams to low beams until the approaching vehicle is out of view.

**NOTE:**

- Automatic High Beam Headlamp Control can be turned on or off using the Uconnect® System, refer to “Uconnect® Settings” in “Understanding Your Instrument Panel” for further information.
- Broken, muddy, or obstructed headlights and taillights of vehicles in the field of view will cause headlights to remain on longer (closer to the vehicle). Also, dirt, film, and other obstructions on the windshield or camera lens will cause the system to function improperly.

If the windshield or Automatic High Beam Headlamp Control mirror is replaced, the mirror must be re-aimed to ensure proper performance. See your local authorized dealer.

**To Activate**

1. Turn the headlight switch to the AUTO headlight position.
2. Push the multifunction lever away from you (toward front of vehicle) to engage the high beam mode.

**NOTE:** This system will not activate until the vehicle is at or above 15 mph (35 km/h).

**To Deactivate**

1. Pull the multifunction lever toward you (or rearward in car) to manually deactivate the system (normal operation of low beams).
2. Push back on the multifunction lever once again to reactivate the system.

**Daytime Running Lights (DRL)**

The Daytime Running Lights will come on whenever the ignition is placed in the RUN position, the headlights are off and the parking brake is off. The headlight switch must be used for normal nighttime driving.

**NOTE:** The Daytime Running Lights can be turned on and off using the Uconnect® System, refer to “Uconnect® Settings” in “Understanding Your Instrument Panel” for further information.

**Lights-On Reminder**

If the headlights or parking lights are on after the ignition is placed in the OFF position, a chime will sound to alert the driver when the driver’s door is opened.

## Fog Lights — If Equipped

The front fog light switch is built into the headlight switch.



Fog Light Switch

 To activate the front fog lights, turn on the parking lights or the low beam headlights and press the

headlight switch. To turn off the front fog lights, either press the headlight switch a second time or turn off the headlight switch.

An indicator light in the instrument cluster illuminates when the fog lights are turned on.

**NOTE:** The fog lights will operate with the low beam headlights or parking lights on. However, selecting the high beam headlights will turn off the fog lights.

### Multifunction Lever

The multifunction lever controls the operation of the turn signals, headlight beam selection and passing lights. The multifunction lever is located on the left side of the steering column.





031563089

### Multifunction Lever

#### Turn Signals

Move the multifunction lever up or down and the arrows on each side of the instrument cluster flash to show proper operation of the front and rear turn signal lights.

#### NOTE:

- If either light remains on and does not flash, or there is a very fast flash rate, check for a defective outside light bulb. If an indicator fails to light when the lever is moved, it would suggest that the indicator bulb is defective.
- A “Turn Signal On” message will appear in the EVIC (if equipped) and a continuous chime will sound if the vehicle is driven more than 1 mile (1.6 km) with either turn signal on.

#### Lane Change Assist

Tap the lever up or down once, without moving beyond the detent, and the turn signal (right or left) will flash three times then automatically turn off.

### High/Low Beam Switch

Push the multifunction lever away from you to switch the headlights to high beam. Pull the multifunction lever toward you to switch the headlights back to low beam.

### Flash-To-Pass

You can signal another vehicle with your headlights by lightly pulling the multifunction lever toward you. This will turn on the high beams headlights until the lever is released.

**NOTE:** If the flash to pass is held for 20 seconds the feature will deactivate.

### Front Map/Reading Lights

Lights are mounted in the overhead console. Each light can be turned on by pressing the lens.

To turn the lights off, press the lens a second time.

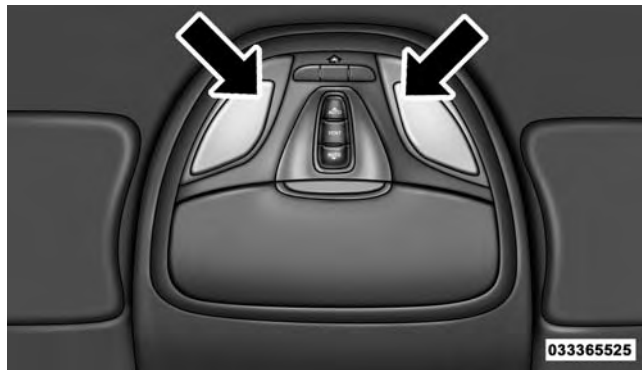

Front Map/Reading Lights

The lights also turn on when a door is opened. The lights will also turn on when the UNLOCK button on the RKE is pressed.

## Interior Lights

The interior lights come on when a door is opened.

To protect the battery, the interior lights will turn off automatically 10 minutes after the ignition is moved to the LOCK position. This will occur if the interior lights were switched on manually or are on because a door is open. This includes the glove box light, but not the trunk light. To restore interior light operation, either turn the ignition to the ON/RUN position or cycle the light switch.

## Dimmer Controls

The dimmer control is part of the headlight switch and is located on the left side of the instrument panel.

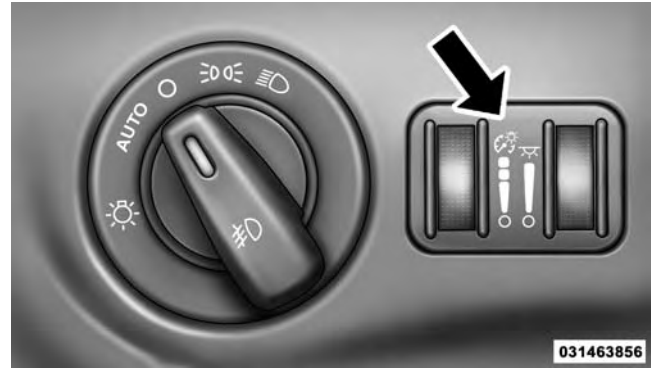

3

Dimmer Controls

With the parking lights or headlights on, rotating the left dimmer control upward will increase the brightness of the instrument panel lights and lighted cupholders (if equipped).

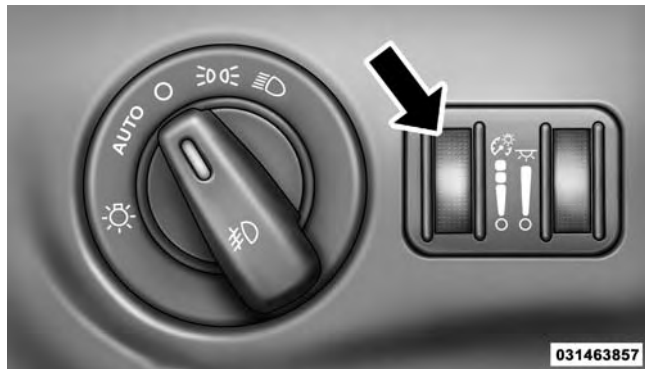

Instrument Panel Dimmer

### Ambient Light Control

Rotate the right dimmer control upward or downward to increase or decrease the brightness of the door handle lights and ambient light located in the overhead console.



Door Handle/Ambient Light Dimmer

### Dome Light Position

Rotate the left dimmer control completely upward to the second detent to turn on the interior lights. The interior lights will remain on when the dimmer control is in this position.

### Interior Light Defeat (OFF)

Rotate the left dimmer control to the extreme bottom OFF position. The interior lights will remain off when the doors are open.

### Parade Mode (Daytime Brightness Feature)

Rotate the instrument panel dimmer control upward to the first detent. This feature brightens all text displays such as the odometer, EVIC (if equipped), and radio when the position lights or headlights are on.

## WINDSHIELD WIPERS AND WASHERS

The multifunction lever operates the windshield wipers and washer when the ignition is placed in the ON/RUN or ACC position. The multifunction lever is located on the left side of the steering column.

3



031563089

Windshield Wiper/Washer Control

## Intermittent Wiper System

Use the intermittent wiper when weather conditions make a single wiping cycle with a variable pause between cycles desirable. Rotate the end of the multifunction lever to the first detent position, and then turn the end of the lever to select the desired delay interval. There are four delay settings, which allow you to regulate the wipe interval from a minimum of one cycle every second to a maximum of approximately 36 seconds between cycles. The delay intervals will double in duration when the vehicle speed is 10 mph (16 km/h) or less.

## Wiper Operation

Rotate the end of the multifunction lever to the first detent, past the intermittent settings for low-speed wiper operation, or to the second detent past the intermittent settings for high-speed wiper operation.

### CAUTION!

- Turn the windshield wipers off when driving through an automatic car wash. Damage to the windshield wipers may result if the wiper control is left in any position other than off.
- In cold weather, always turn off the wiper switch and allow the wipers to return to the "Park" position before turning off the engine. If the wiper switch is left on and the wipers freeze to the windshield, damage to the wiper motor may occur when the vehicle is restarted.
- Always remove any buildup of snow that prevents the windshield wiper blades from returning to the off position. If the windshield wiper control is turned off and the blades cannot return to the off position, damage to the wiper motor may occur.

## Mist Feature

Rotate the end of the lever downward to the Mist position to activate a single wipe cycle to clear off road mist or spray from a passing vehicle. The wipers will continue to operate until you release the multifunction lever.

**NOTE:** The mist feature does not activate the washer pump; therefore, no washer fluid will be sprayed on the windshield. The wash function must be used in order to spray the windshield with washer fluid.

## Windshield Washers

To use the washer, push the multifunction lever inward (toward the steering column) and hold it for as long as washer spray is desired.

If you activate the washer while the windshield wiper control is in the delay range, the wipers will operate for

two wipe cycles after releasing the lever and then resume the intermittent interval previously selected.

If you activate the washer while the windshield wiper is turned off, the wipers will operate for three wipe cycles and then turn off.

### WARNING!

**Sudden loss of visibility through the windshield could lead to a collision. You might not see other vehicles or other obstacles. To avoid sudden icing of the windshield during freezing weather, warm the windshield with the defroster before and during windshield washer use.**

## Headlights On With Wipers (Available With Automatic Headlights Only)

When this feature is active, the headlights will turn on approximately 10 seconds after the wipers are turned on

if the headlight switch is placed in the AUTO position. In addition, the headlights will turn off when the wipers are turned off if they were turned on by this feature.

The Headlights On with Wipers feature can be turned on and off using the Uconnect® System, refer to “Uconnect® Settings” in “Understanding Your Instrument Panel” for further information.

### **Rain Sensing Wipers — If Equipped**

This feature senses moisture on the windshield and automatically activates the wipers for the driver. The feature is especially useful for road splash or over spray from the windshield washers of the vehicle ahead. Rotate the end of the multifunction lever to one of four settings to activate this feature.

The sensitivity of the system can be adjusted with the multifunction lever. Wiper delay position 1 is the least sensitive, and wiper delay position 4 is the most sensitive. Setting 3 should be used for normal rain conditions.

Settings 1 and 2 can be used if the driver desires less wiper sensitivity. Setting 4 can be used if the driver desires more sensitivity. The rain sense wipers will automatically change between an intermittent wipe, slow wipe and a fast wipe depending on the amount of moisture that is sensed on the windshield. Place the wiper switch in the OFF position when not using the system.

The Rain Sensing feature can be turned on and off using the Uconnect® System, refer to “Uconnect® Settings” in “Understanding Your Instrument Panel” for further information.

#### **NOTE:**

- The Rain Sensing feature will not operate when the wiper speed is in the low or high position.



- The Rain Sensing feature may not function properly when ice or dried salt water is present on the windshield.
- Use of Rain-X® or products containing wax or silicone may reduce rain sensor performance.

The Rain Sensing system has protective features for the wiper blades and arms. It will not operate under the following conditions:

- **Low Temperature Wipe Inhibit** — The Rain Sensing feature will not operate when the ignition is placed in the RUN position, the vehicle is stationary and the outside temperature is below 32°F (0°C), unless the wiper control on the multifunction lever is moved, the vehicle speed becomes greater than 0 mph (0 km/h) or the outside temperature rises above freezing.
- **Neutral Wipe Inhibit** — The Rain Sensing feature will not operate when the ignition is placed in the RUN position, the automatic transmission shift lever is in the NEUTRAL position and the vehicle speed is less than 5 mph (8 km/h), unless the wiper control on the multifunction lever is moved or the shift lever is moved out of the NEUTRAL position.
- **Remote Start Mode Inhibit** — On vehicles equipped with Remote Starting system, Rain Sensing wipers are not operational when the vehicle is in the remote start mode. Once the operator is in the vehicle and has placed the ignition switch in the ON/RUN position, rain sensing wiper operation can resume, if it has been selected, and no other inhibit conditions (mentioned previously) exist.

## TILT/TELESCOPING STEERING COLUMN

This feature allows you to tilt the steering column upward or downward. It also allows you to lengthen or shorten the steering column. The tilt/telescoping control handle is located below the steering wheel at the end of the steering column.

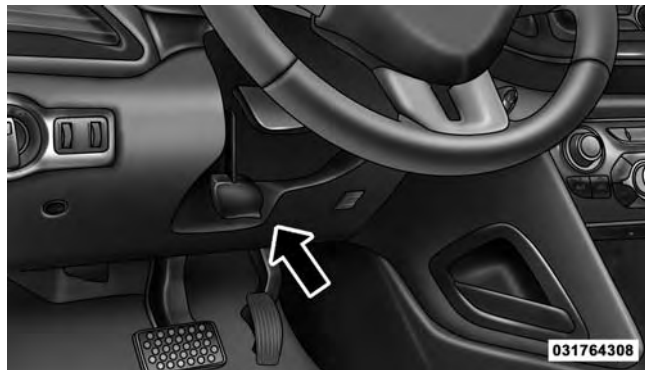

Tilt/Telescoping Control Handle

To unlock the steering column, pull the control handle down. To tilt the steering column, move the steering wheel upward or downward as desired. To lengthen or shorten the steering column, pull the steering wheel outward or push it inward as desired. To lock the steering column in position, push the control handle up until fully engaged.

### WARNING!

Do not adjust the steering column while driving. Adjusting the steering column while driving or driving with the steering column unlocked, could cause the driver to lose control of the vehicle. Failure to follow this warning may result in serious injury or death.

## HEATED STEERING WHEEL — IF EQUIPPED

The steering wheel contains a heating element that helps warm your hands in cold weather. The heated steering wheel has only one temperature setting. Once the heated steering wheel has been turned on it will operate for up to 80 minutes before automatically shutting off. The heated steering wheel can shut off early or may not turn on when the steering wheel is already warm.

The heated steering wheel can be turned on and off using the Uconnect® System.

Touch the “Controls” soft-key then touch the “Heated Wheel” soft-key to turn on the heated steering wheel. Press the “Heated Wheel” soft-key a second time to turn the heated steering wheel off.



Controls Soft-Key



### Heated Steering Wheel Soft-Key

**NOTE:** The engine must be running for the heated steering wheel to operate.

### Vehicles Equipped With Remote Start

On models that are equipped with remote start, the heated steering wheel can be programmed to come on

during a remote start. Refer to “Remote Starting System — If Equipped” in “Things To Know Before Starting Your Vehicle” for further information.

### WARNING!

- Persons who are unable to feel pain to the skin because of advanced age, chronic illness, diabetes, spinal cord injury, medication, alcohol use, exhaustion, or other physical conditions must exercise care when using the steering wheel heater. It may cause burns even at low temperatures, especially if used for long periods.
- Do not place anything on the steering wheel that insulates against heat, such as a blanket or steering wheel covers of any type and material. This may cause the steering wheel heater to overheat.

## ELECTRONIC SPEED CONTROL — IF EQUIPPED

When engaged, the Electronic Speed Control takes over accelerator operations at speeds greater than 25 mph (40 km/h).

The Electronic Speed Control buttons are located on the right side of the steering wheel.

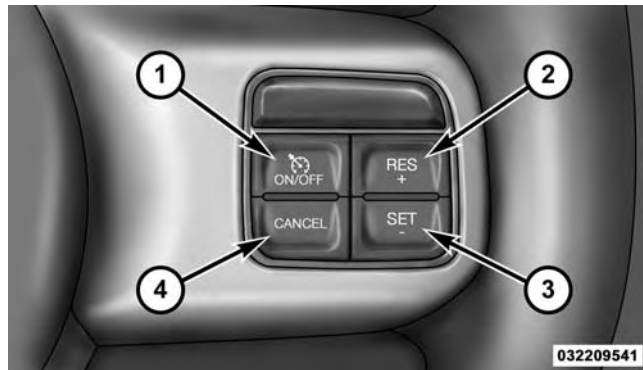

Electronic Speed Control Buttons

1 — ON/OFF  
2 — RES +

3 — SET -  
4 — CANCEL

**NOTE:** In order to ensure proper operation, the Electronic Speed Control system has been designed to shut down if multiple Speed Control functions are operated at the same time. If this occurs, the Electronic Speed Control system can be reactivated by pushing the Electronic Speed Control ON/OFF button and resetting the desired vehicle set speed.

### To Activate

Push the ON/OFF button to activate the Electronic Speed Control. The Cruise Indicator Light in the Electronic Vehicle Information Center (EVIC) will illuminate. To turn the system off, push the ON/OFF button a second time. The Cruise Indicator Light will turn off. The system should be turned off when not in use.

### WARNING!

**Leaving the Electronic Speed Control system on when not in use is dangerous. You could accidentally set the system or cause it to go faster than you want. You could lose control and have an accident. Always leave the system OFF when you are not using it.**

### To Set A Desired Speed

Turn the Electronic Speed Control ON.

**NOTE:** The vehicle should be traveling at a steady speed and on level ground before pressing the SET button.

When the vehicle has reached the desired speed, press the SET (-) button and release. Release the accelerator and the vehicle will operate at the selected speed.

**NOTE:** After pressing the SET button "Cruise Control Set" message is displayed for five seconds or until another switch is pressed.

### *For Premium Clusters Only*

- When set to analog mode: The red outer line on the speedometer changes from red to white to identify set speed.
- When set to digital mode: The MPH reading turns from white to red to identify set speed.

### **To Deactivate**

A soft tap on the brake pedal, pushing the CANCEL button, or normal brake pressure while slowing the vehicle will deactivate Electronic Speed Control without erasing the set speed memory. Pressing the ON/OFF button or turning the ignition switch OFF erases the set speed memory.

**NOTE:** After pressing the OFF button a “Cruise Control Off” message is displayed for five seconds or until another switch is pressed.

### *For Premium Clusters Only*

- When set to analog mode: The white outer line on the speedometer returns to red.
- When set to digital mode: The MPH reading returns from red to white.

### **To Resume Speed**

To resume a previously set speed, push the RES (+) button and release. Resume can be used at any speed above 20 mph (32 km/h).

### **To Vary The Speed Setting**

#### **To Increase Speed**

When the Electronic Speed Control is set, you can increase speed by pushing the RES (+) button.

The speed increment shown is dependant on the speed of U.S. (mph) or Metric (km/h) units:

#### *U.S. Speed (mph)*

- Pressing the RES (+) button once will result in a 1 mph increase in set speed. Each subsequent tap of the button results in an increase of 1 mph.
- If the button is continually pressed, the set speed will continue to increase until the button is released, then the new set speed will be established.

#### *Metric Speed (km/h)*

- Pressing the RES (+) button once will result in a 2 km/h increase in set speed. Each subsequent tap of the button results in an increase of 2 km/h.
- If the button is continually pressed, the set speed will continue to increase until the button is released, then the new set speed will be established.

#### **To Decrease Speed**

When the Electronic Speed Control is set, you can decrease speed by pushing the SET (-) button.

The speed decrement shown is dependant on the speed of U.S. (mph) or Metric (km/h) units:

#### *U.S. Speed (mph)*

- Pressing the SET (-) button once will result in a 1 mph decrease in set speed. Each subsequent tap of the button results in a decrease of 1 mph.
- If the button is continually pressed, the set speed will continue to decrease until the button is released, then the new set speed will be established.

#### *Metric Speed (km/h)*

- Pressing the SET (-) button once will result in a 2 km/h decrease in set speed. Each subsequent tap of the button results in a decrease of 2 km/h.



- If the button is continually pressed, the set speed will continue to decrease until the button is released, then the new set speed will be established.

### To Accelerate For Passing

Press the accelerator as you would normally. When the pedal is released, the vehicle will return to the set speed.

### Using Electronic Speed Control On Hills

The transmission may downshift on hills to maintain the vehicle set speed.

**NOTE:** The Electronic Speed Control system maintains speed up and down hills. A slight speed change on moderate hills is normal.

On steep hills, a greater speed loss or gain may occur so it may be preferable to drive without Electronic Speed Control.

### WARNING!

Electronic Speed Control can be dangerous where the system cannot maintain a constant speed. Your vehicle could go too fast for the conditions, and you could lose control and have an accident. Do not use Electronic Speed Control in heavy traffic or on roads that are winding, icy, snow-covered or slippery.

### PARKSENSE® REAR PARK ASSIST — IF EQUIPPED

The ParkSense® Rear Park Assist system provides visual and audible indications of the distance between the rear fascia and a detected obstacle when backing up, e.g. during a parking maneuver. Refer to “ParkSense® System Usage Precautions” for limitations of this system and recommendations.

ParkSense® will retain the last system state (enabled or disabled) from the last ignition cycle when the ignition is changed to the ON/RUN position.

ParkSense® can be active only when the shift lever is in REVERSE. If ParkSense® is enabled at this shift lever position, the system will remain active until the vehicle speed is increased to approximately 11 mph (18 km/h) or above. The system will become active again if the vehicle speed is decreased to speeds less than approximately 10 mph (16 km/h).

### **ParkSense® Sensors**

The four ParkSense® sensors, located in the rear fascia/bumper, monitor the area behind the vehicle that is within the sensors' field of view. The sensors can detect obstacles from approximately 12 in (30 cm) up to 59 in (150 cm) from the rear fascia/bumper in the horizontal direction, depending on the location, type and orientation of the obstacle.

### **ParkSense® Warning Display**

The ParkSense® Warning screen will only be displayed if Sound and Display is selected from the Uconnect® System. Refer to "Uconnect® Settings" in "Understanding Your Instrument Panel" for further information.

The ParkSense® Warning screen is located within the Electronic Vehicle Information Center (EVIC). It provides visual warnings to indicate the distance between the rear fascia/bumper and the detected obstacle. Refer to "Electronic Vehicle Information Center (EVIC)/Settings" in "Understanding Your Instrument Panel" for further information.

### **ParkSense® Display**

When the vehicle is in REVERSE, the warning display will turn ON indicating the system status.



Park Assist Ready



Park Assist System Off

The system will indicate a detected obstacle by showing a single arc in one or more regions based on the obstacle's distance and location relative to the vehicle.

## 258 UNDERSTANDING THE FEATURES OF YOUR VEHICLE

If an obstacle is detected in the center rear region, the display will show a single solid arc in the center rear region and will produce a one-half second tone. As the vehicle moves closer to the obstacle, the display will show the single arc moving closer to the vehicle and the sound tone will change from slow, to fast, to continuous.

If an obstacle is detected in the left and/or right rear region, the display will show a single flashing arc in the left and/or right rear region and will produce a fast sound tone. As the vehicle moves closer to the obstacle, the display will show the single arc moving closer to the vehicle and the sound tone will change from fast, to continuous.



One-Half Second Tone



Slow Tone



Slow Tone



Fast Tone



Fast Tone



Fast Tone



Continuous Tone



Continuous Tone

The vehicle is close to the obstacle when the warning display shows one flashing arc and sounds a continuous tone. The following chart shows the warning alert operation when the system is detecting an obstacle:



WARNING ALERTS							
Rear Distance (in/cm)	Greater than 79 in (200 cm)	79-59 in (200-150 cm)	59-47 in (150-120 cm)	47-39 in (120-100 cm)	39-25 in (100-65 cm)	25-12 in (65-30 cm)	Less than 12 in (30 cm)
Audible Alert Chime	None	Single 1/2-Second Tone (for rear center only)	Slow (for rear center only)	Slow (for rear center only)	Fast (for rear center only)	Fast	Continuous
Arc — Left Rear	None	None	None	None	None	2nd Flashing	1st Flashing
Arc — Center Rear	None	6th Solid	5th Solid	4th Solid	3rd Flashing	2nd Flashing	1st Flashing
Arc — Right Rear	None	None	None	None	None	2nd Flashing	1st Flashing

## Enabling And Disabling ParkSense®

ParkSense® can be enabled and disabled using the Uconnect® System. The available choices are: Off, Sound Only, or Sound and Display. Refer to “Uconnect® Settings” in “Understanding Your Instrument Panel” for further information.

When the ParkSense® soft-key is pressed to disable the system, the EVIC will display the “PARK ASSIST SYSTEM OFF” message for approximately five seconds. Refer to “Electronic Vehicle Information Center (EVIC)” in “Understanding Your Instrument Panel” for further information. When the shift lever is moved to REVERSE and the system is disabled, the EVIC will display the “PARK ASSIST SYSTEM OFF” message for as long as the vehicle is in REVERSE.

## Service The ParkSense® Rear Park Assist System

During vehicle start up, when the ParkSense® Rear Park Assist system has detected a fault condition, the Electronic Vehicle Information Center (EVIC) will actuate a single chime, once per ignition cycle, and it will display the “WIPE OFF REAR PARK ASSIST SENSORS”, “SERVICE PARK ASSIST SENSORS” or “SERVICE PARK ASSIST SYSTEM” message. Refer to “Electronic Vehicle Information Center (EVIC)” in “Understanding Your Instrument Panel” for further information. When the shift lever is moved to REVERSE and the system has detected a faulted condition, the EVIC will display the “WIPE OFF REAR PARK ASSIST SENSORS”, “SERVICE PARK ASSIST SENSORS” or the “SERVICE PARK ASSIST SYSTEM” message for as long as the vehicle is in REVERSE. Under this condition, ParkSense® will not operate.

If “WIPE OFF REAR PARK ASSIST SENSORS” appears in the EVIC make sure the outer surface and the underside of the rear fascia/bumper is clean and clear of snow, ice, mud, dirt or other obstruction and then cycle the ignition. If the message continues to appear, see an authorized dealer.



Wipe Off Rear Park Assist Sensors

If “SERVICE PARK ASSIST SENSORS” or “SERVICE PARK ASSIST SYSTEM” appears in the EVIC, see an authorized dealer.

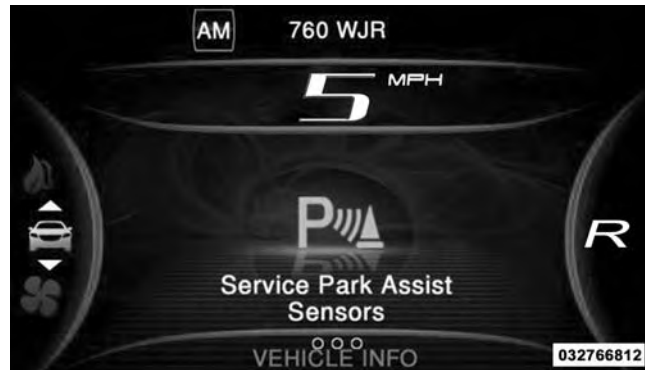

Service Park Assist Sensors

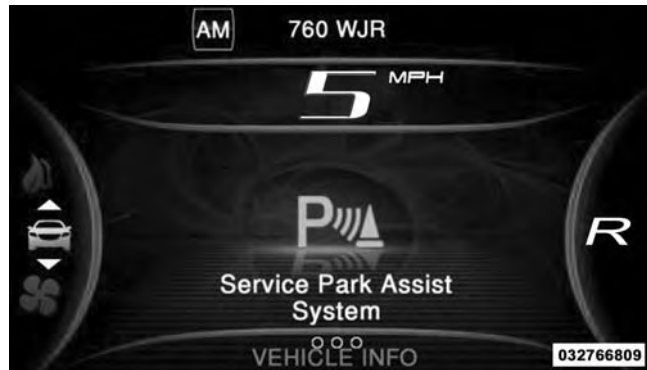

### Service Park Assist System

The ParkSense® Rear Park Assist system will be automatically disabled when there are faulted conditions outside of the ParkSense® Rear Park Assist system that inhibit the feature from functioning properly. The Electronic Vehicle Information Center (EVIC) will actuate a single chime, once per ignition cycle, and it will display

the "PARK ASSIST SYSTEM DISABLED" message. If "PARK ASSIST SYSTEM DISABLED" appears in the EVIC, cycle the ignition. If the message appears again, see an authorized dealer.



### Park Assist System Disabled

## Cleaning The ParkSense® System

Clean the ParkSense® sensors with water, car wash soap and a soft cloth. Do not use rough or hard cloths. Do not scratch or poke the sensors. Otherwise, you could damage the sensors.

## ParkSense® System Usage Precautions

### NOTE:

- Ensure that the outer surface and the underside of the rear bumper is clean and clear of snow, ice, mud, dirt or other obstruction to keep the ParkSense® system operating properly.
- Jackhammers, large trucks, and other vibrations could affect the performance of ParkSense®.
- When you turn ParkSense® off, the EVIC will display “PARK ASSIST SYSTEM OFF.” Furthermore, once you

turn ParkSense® off, it remains off until you turn it on again, even if you cycle the ignition key.

- When you move the shift lever to the REVERSE position and ParkSense® is turned off, the EVIC will display the “PARK ASSIST SYSTEM OFF” message for as long as the vehicle is in REVERSE.
- Clean the ParkSense® sensors regularly, taking care not to scratch or damage them. The sensors must not be covered with ice, snow, slush, mud, dirt or debris. Failure to do so can result in the system not working properly. The ParkSense® system might not detect an obstacle behind the fascia/bumper, or it could provide a false indication that an obstacle is behind the fascia/bumper.
- Ensure the ParkSense® system is OFF if objects such as bicycle carriers, trailer hitches, etc., are placed within 12 in (30 cm) from the rear fascia/ bumper. Failure to do so can result in the system misinterpreting a close

object as a sensor problem, causing the “SERVICE PARK ASSIST SYSTEM” message to be displayed in the EVIC.

### CAUTION!

- ParkSense® is only a parking aid and it is unable to recognize every obstacle, including small obstacles. Parking curbs might be temporarily detected or not detected at all. Obstacles located above or below the sensors will not be detected when they are in close proximity.
- The vehicle must be driven slowly when using ParkSense® in order to be able to stop in time when an obstacle is detected. It is recommended that the driver looks over his/her shoulder when using ParkSense®.

### WARNING!

- Drivers must be careful when backing up even when using ParkSense®. Always check carefully behind your vehicle, look behind you, and be sure to check for pedestrians, animals, other vehicles, obstructions, and blind spots before backing up. You are responsible for safety and must continue to pay attention to your surroundings. Failure to do so can result in serious injury or death.

*(Continued)*

**WARNING! (Continued)**

- Before using ParkSense®, it is strongly recommended that the ball mount and hitch ball assembly is disconnected from the vehicle when the vehicle is not used for towing. Failure to do so can result in injury or damage to vehicles or obstacles because the hitch ball will be much closer to the obstacle than the rear fascia when the loudspeaker sounds the continuous tone. Also, the sensors could detect the ball mount and hitch ball assembly, depending on its size and shape, giving a false indication that an obstacle is behind the vehicle.

**PARKVIEW® REAR BACK UP CAMERA — IF EQUIPPED**

Your vehicle may be equipped with the ParkView® Rear Back Up Camera that allows you to see an on-screen image of the rear surroundings of your vehicle whenever

the shift lever is put into REVERSE. The image will be displayed on the touchscreen display along with a caution note to “check entire surroundings” across the top of the screen. After five seconds this note will disappear. The ParkView® camera is located on the rear of the vehicle above the rear License plate.

When the vehicle is shifted out of REVERSE, the rear camera mode is exited and the navigation or audio screen appears again.

When displayed, static grid lines will illustrate the width of the vehicle and will show separate zones that will help indicate the distance to the rear of the vehicle. The following table shows the approximate distances for each zone:

Zone	Distance to the rear of the vehicle
Red	0 - 1 ft (0 - 30 cm)
Yellow	1 ft - 3 ft (30 cm - 1 m)
Green	3 ft or greater (1 m or greater)

**WARNING!**

Drivers must be careful when backing up even when using the ParkView® Rear Back Up Camera. Always check carefully behind your vehicle, and be sure to check for pedestrians, animals, other vehicles, obstructions, or blind spots before backing up. You are responsible for the safety of your surroundings and must continue to pay attention while backing up. Failure to do so can result in serious injury or death.

**CAUTION!**

- To avoid vehicle damage, ParkView® should only be used as a parking aid. The ParkView® camera is unable to view every obstacle or object in your drive path.
- To avoid vehicle damage, the vehicle must be driven slowly when using ParkView® to be able to stop in time when an obstacle is seen. It is recommended that the driver look frequently over his/her shoulder when using ParkView®.



**NOTE:** If snow, ice, mud, or any foreign substance builds up on the camera lens, clean the lens, rinse with water, and dry with a soft cloth. Do not cover the lens.

### Turning ParkView® On Or Off — With Touchscreen Radio

1. Turn the Radio on.
2. Press the “More” soft-key.
3. Press the “Settings” soft-key.
4. Press the “Safety & Driving Assistance” soft-key.
5. Press the check box soft key next to “Parkview® Backup Camera” to enable/disable.

### OVERHEAD CONSOLE

The overhead console contains courtesy/reading lights and storage for sunglasses. Universal Garage Door Opener (HomeLink®) and power sunroof switches may also be included, if equipped.

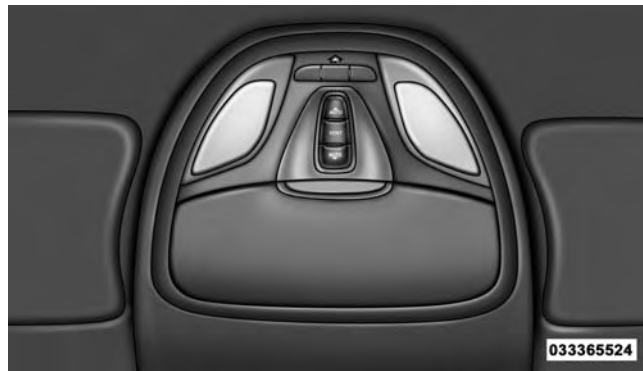

Overhead Console

### Front Map/Reading Lights

Lights are mounted in the overhead console. Each light can be turned on by pressing the lens.

To turn the lights off, press the lens a second time.

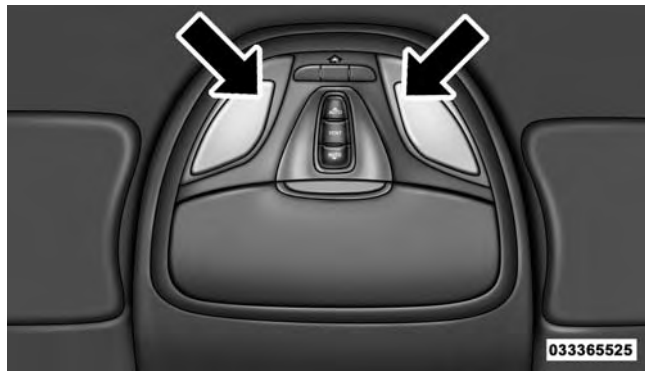

Front Map/Reading Lights

The lights also turn on when a door is opened. The lights will also turn on when the UNLOCK button on the RKE is pressed.

### Sunglass Bin Door

At the front of the console a compartment is provided for the storage of a pair of sunglasses. The storage compartment access is a “push/push” design. Push the chrome pad on the door to open. Push the chrome pad on the door to close.

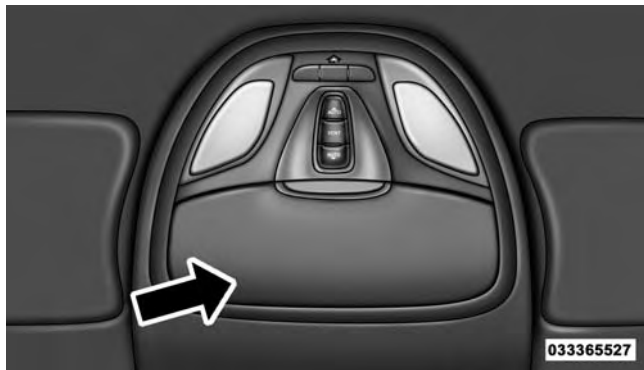

Sunglass Bin Door

**GARAGE DOOR OPENER — IF EQUIPPED**

HomeLink® replaces up to three hand-held transmitters that operate devices such as garage door openers, motorized gates, lighting or home security systems. The HomeLink® unit is powered by your vehicle's 12 Volt battery.

The HomeLink® buttons, located on either the overhead console, headliner or sunvisor, designate the three different HomeLink® channels. The HomeLink® indicator is located above the center button.

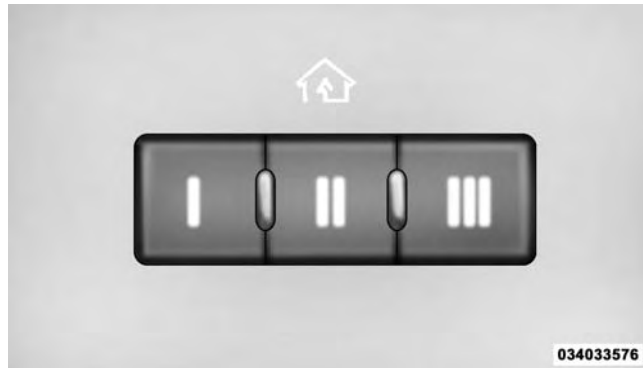
**HomeLink® Buttons/Overhead Consoles**



034000355

### HomeLink® Buttons/Sunvisor/Headliner

**NOTE:** HomeLink® is disabled when the Vehicle Security Alarm is active.

### Before You Begin Programming HomeLink®

Be sure that your vehicle is parked outside of the garage before you begin programming.

For more efficient programming and accurate transmission of the radio-frequency signal it is recommended that a new battery be placed in the hand-held transmitter of the device that is being programmed to the HomeLink® system.

Erase all channels before you begin programming. To erase the channels place the ignition in the ON/RUN position and press and hold the two outside HomeLink® buttons (I and III) for up to 20 seconds or until the red indicator flashes.

### NOTE:

- Erasing all channels should only be performed when programming HomeLink® for the first time. Do not erase channels when programming additional buttons.
- If you have any problems, or require assistance, please call toll-free 1-800-355-3515 or, on the Internet at [www.HomeLink.com](http://www.HomeLink.com) for information or assistance.

## Programming A Rolling Code

For programming garage door openers that were manufactured after 1995. These garage door openers can be identified by the "LEARN" or "TRAIN" button located where the hanging antenna is attached to the garage door opener. It is NOT the button that is normally used to open and close the door. The name and color of the button may vary by manufacturer.

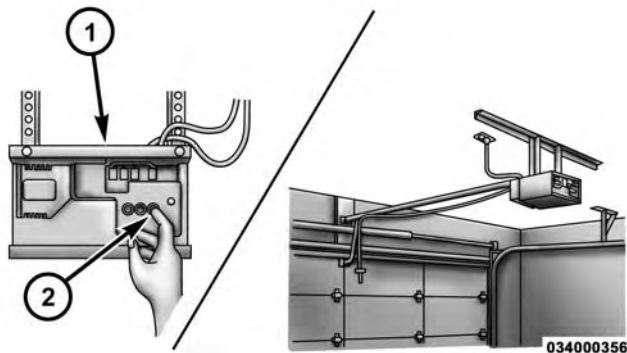

Training The Garage Door Opener

- 1 — Door Opener
- 2 — Training Button

1. Cycle the ignition to the ON/RUN position.

2. Place the hand-held transmitter 1 to 3 in (3 to 8 cm) away from the HomeLink® button you wish to program while keeping the HomeLink® indicator light in view.
3. Simultaneously press and hold both the HomeLink® button you want to program and the hand-held transmitter button.
4. Continue to hold both buttons and observe the indicator light. The HomeLink® indicator will flash slowly and then rapidly after HomeLink® has received the frequency signal from the hand-held transmitter. Release both buttons after the indicator light changes from slow to rapid.
5. At the garage door opener motor (in the garage), locate the “LEARN” or “TRAINING” button. This can usually be found where the hanging antenna wire is attached to the garage door opener/device motor.

Firmly press and release the “LEARN” or “TRAINING” button. On some garage door openers/devices there may be a light that blinks when the garage door opener/device is in the LEARN/TRAIN mode.

**NOTE:** You have 30 seconds in which to initiate the next step after the LEARN button has been pressed.

6. Return to the vehicle and press the programmed HomeLink® button twice (holding the button for two seconds each time). If the garage door opener/device activates, programming is complete.

**NOTE:** If the garage door opener/device does not activate, press the button a third time (for two seconds) to complete the training.

To program the remaining two HomeLink® buttons, repeat each step for each remaining button. DO NOT erase the channels.

### Reprogramming A Single HomeLink® Button

To reprogram a channel that has been previously trained, follow these steps:

1. Cycle the ignition to the ON/RUN position.
2. Press and hold the desired HomeLink® button until the indicator light begins to flash after 20 seconds. **Do not release the button.**
3. **Without releasing the button** proceed with “Programming A Rolling Code” step 2 and follow all remaining steps.

### Programming A Non-Rolling Code

For programming Garage Door Openers manufactured before 1995.

1. Cycle the ignition to the ON/RUN position.

2. Place the hand-held transmitter 1 to 3 in (3 to 8 cm) away from the HomeLink® button you wish to program while keeping the HomeLink® indicator light in view.
3. Simultaneously press and hold both the HomeLink® button you want to program and the hand-held transmitter button.
4. Continue to hold both buttons and observe the indicator light. HomeLink® indicator will flash slowly and then rapidly after HomeLink® has received the frequency signal from the hand-held transmitter. Release both buttons after the indicator light changes from slow to rapid.
5. Press and hold the programmed HomeLink® button and observe the indicator light.
  - If the indicator light stays on constantly, programming is complete and the garage door/device should activate when the HomeLink® button is pressed.

- To program the remaining two HomeLink® buttons, repeat each step for each remaining button. **DO NOT** erase the channels.

### Reprogramming A Single HomeLink® Button

To reprogram a channel that has been previously trained, follow these steps:

1. Cycle the ignition to the ON/RUN position.
2. Press and hold the desired HomeLink® button until the indicator light begins to flash after 20 seconds. **Do not release the button.**
3. **Without releasing the button** proceed with “Programming A Non-Rolling Code” step 2 and follow all remaining steps.

### Canadian/Gate Operator Programming

For programming transmitters in Canada/United States that require the transmitter signals to “time-out” after several seconds of transmission.

Canadian radio frequency laws require transmitter signals to time-out (or quit) after several seconds of transmission – which may not be long enough for HomeLink® to pick up the signal during programming. Similar to this Canadian law, some U.S. gate operators are designed to time-out in the same manner.

It may be helpful to unplug the device during the cycling process to prevent possible overheating of the garage door or gate motor.

1. Cycle the ignition to the ON/RUN position.



2. Place the hand-held transmitter 1 to 3 in (3 to 8 cm) away from the HomeLink® button you wish to program while keeping the HomeLink® indicator light in view.
3. Continue to press and hold the HomeLink® button, while you press and release (“cycle”), your hand-held transmitter every two seconds until HomeLink® has successfully accepted the frequency signal. The indicator light will flash slowly and then rapidly when fully trained.
4. Watch for the HomeLink® indicator to change flash rates. When it changes, it is programmed. It may take up to 30 seconds or longer in rare cases. The garage door may open and close while you are programming.
5. Press and hold the programmed HomeLink® button and observe the indicator light.

- If the indicator light stays on constantly, programming is complete and the garage door/device should activate when the HomeLink® button is pressed.
- To program the two remaining HomeLink® buttons, repeat each step for each remaining button. **DO NOT** erase the channels.

If you unplugged the garage door opener/device for programming, plug it back in at this time.

### Reprogramming A Single HomeLink® Button

To reprogram a channel that has been previously trained, follow these steps:

1. Cycle the ignition to the ON/RUN position.
2. Press and hold the desired HomeLink® button until the indicator light begins to flash after 20 seconds. **Do not release the button.**

3. **Without releasing the button** proceed with “Canadian/Gate Operator Programming” step 2 and follow all remaining steps.

### Using HomeLink®

To operate, press and release the programmed HomeLink® button. Activation will now occur for the programmed device (i.e., garage door opener, gate operator, security system, entry door lock, home/office lighting, etc.). The hand-held transmitter of the device may also be used at any time.

### Security

It is advised to erase all channels before you sell or turn in your vehicle.

To do this, press and hold the two outside buttons for 20 seconds until the red indicator flashes. Note that all channels will be erased. Individual channels cannot be erased.

The HomeLink® Universal Transceiver is disabled when the Vehicle Security Alarm is active.

### Troubleshooting Tips

If you are having trouble programming HomeLink®, here are some of the most common solutions:

- Replace the battery in the original hand-held transmitter.
- Press the LEARN button on the Garage Door Opener to complete the training for a Rolling Code.

- Did you unplug the device for programming and remember to plug it back in?

If you have any problems, or require assistance, please call toll-free 1-800-355-3515 or, on the Internet at [www.HomeLink.com](http://www.HomeLink.com) for information or assistance.

**WARNING!**

Vehicle exhaust contains carbon monoxide, a dangerous gas. Do not run your vehicle in the garage while programming the transceiver. Exhaust gas can cause serious injury or death.

**WARNING!**

Your motorized door or gate will open and close while you are programming the universal transceiver. Do not program the transceiver if people, pets or other objects are in the path of the door or gate. Only use this transceiver with a garage door opener that has a “stop and reverse” feature as required by Federal safety standards. This includes most garage door opener models manufactured after 1982. Do not use a garage door opener without these safety features. Call toll-free 1-800-355-3515 or, on the Internet at [www.HomeLink.com](http://www.HomeLink.com) for safety information or assistance.

## General Information

This device complies with FCC rules Part 15 and Industry Canada RSS-210. Operation is subject to the following two conditions:

1. This device may not cause harmful interference.
2. This device must accept any interference that may be received including interference that may cause undesired operation.

### NOTE:

- The transmitter has been tested and it complies with FCC and IC rules. Changes or modifications not expressly approved by the party responsible for compliance could void the user's authority to operate the device.
- The term IC before the certification/registration number only signifies that Industry Canada technical specifications were met.

## POWER SUNROOF — IF EQUIPPED

The power sunroof switch is located between the sun visors on the overhead console.

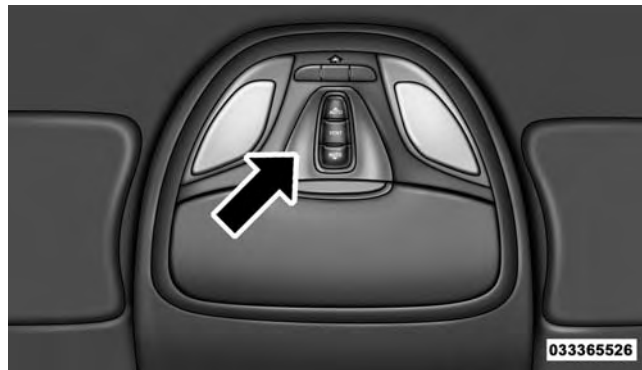

Power Sunroof Switch

**WARNING!**

- Never leave children unattended in a vehicle, or with access to an unlocked vehicle. Never leave the Key Fob in or near the vehicle, or in a location accessible to children. Do not leave the ignition of a vehicle equipped with Keyless Enter-N-Go™ in the ACC or ON/RUN mode. Occupants, particularly unattended children, can become entrapped by the power sunroof while operating the power sunroof switch. Such entrapment may result in serious injury or death.
- In a collision, there is a greater risk of being thrown from a vehicle with an open sunroof. You could also be seriously injured or killed. Always fasten your seat belt properly and make sure all passengers are also properly secured.

*(Continued)*

**WARNING! (Continued)**

- Do not allow small children to operate the sunroof. Never allow your fingers, other body parts, or any object, to project through the sunroof opening. Injury may result.

**Opening Sunroof — Express**

Press the switch rearward and release it within one-half second. The sunroof and sunshade will open automatically from any position. The sunroof and sunshade will open fully and stop automatically. This is called “Express Open”. During Express Open operation, any movement of the sunroof switch will stop the sunroof.

### **Opening Sunroof — Manual Mode**

To open the sunroof, press and hold the switch rearward to full open. Any release of the switch will stop the movement. The sunroof and sunshade will remain in a partially opened condition until the switch is pushed and held rearward again.

### **Closing Sunroof — Express**

Press the switch forward and release it within one-half second and the sunroof will close automatically from any position. The sunroof will close fully and stop automatically. This is called “Express Close”. During Express Close operation, any movement of the switch will stop the sunroof.

### **Closing Sunroof — Manual Mode**

To close the sunroof, press and hold the switch in the forward position. Any release of the switch will stop the

movement and the sunroof will remain in a partially closed condition until the switch is pushed and held forward again.

### **Pinch Protect Feature**

This feature will detect an obstruction in the opening of the sunroof during Express Close operation. If an obstruction in the path of the sunroof is detected, the sunroof will automatically retract. Remove the obstruction if this occurs. Next, press the switch forward and release to Express Close.

**NOTE:** If three consecutive sunroof close attempts result in Pinch Protect reversals, the fourth close attempt will be a Manual Close movement with Pinch Protect disabled.

### **Pinch Protect Override**

If a known obstruction (ice, debris, etc.) prevents closing the sunroof, attempt to remove the obstruction and then press and hold the switch forward until the sunroof fully closes.

**NOTE:** Pinch protection is disabled while the switch is pressed.

### **Venting Sunroof — Express**

Press and release the Vent button within one half second and the sunroof will open to the vent position. This is called “Express Vent”, and it will occur regardless of sunroof position. During Express Vent operation, any movement of the switch will stop the sunroof.

### **Sunshade Operation**

The sunshade can be opened manually. However, the sunshade will open automatically as the sunroof opens.

**NOTE:** The sunshade cannot be closed if the sunroof is open.

### **Wind Buffeting**

Wind buffeting can be described as the perception of pressure on the ears or a helicopter-type sound in the ears. Your vehicle may exhibit wind buffeting with the windows down, or the sunroof (if equipped) in certain open or partially open positions. This is a normal occurrence and can be minimized. If the buffeting occurs with the rear windows open, open the front and rear windows together to minimize the buffeting. If the buffeting occurs with the sunroof open, adjust the sunroof opening to minimize the buffeting or open any window.

### **Sunroof Maintenance**

Use only a nonabrasive cleaner and a soft cloth to clean the glass panel.

## ELECTRICAL POWER OUTLETS — IF EQUIPPED

The 12 Volt (13 Amp) instrument panel power outlet is located on the lower instrument panel, below the climate controls. The power outlet has power available when the ignition switch is in the ACC or RUN position. The power outlet will also operate a conventional cigar lighter unit (if equipped with an optional Smoker's Package).



**Instrument Panel Outlet**

**NOTE:** To ensure proper operation a MOPAR® cigar knob and element must be used.



**CAUTION!**

- Do not exceed the maximum power of 160 Watts (13 Amps) at 12 Volts. If the 160 Watt (13 Amp) power rating is exceeded the fuse protecting the system will need to be replaced.
- Power outlets are designed for accessory plugs only. Do not insert any other object in the power outlets as this will damage the outlet and blow the fuse. Improper use of the power outlet can cause damage not covered by your New Vehicle Limited Warranty.

There is also a 12 Volt power outlet located in the center console. This power outlet has power available only when the ignition is placed in the ACC or RUN position.



Center Console Outlet

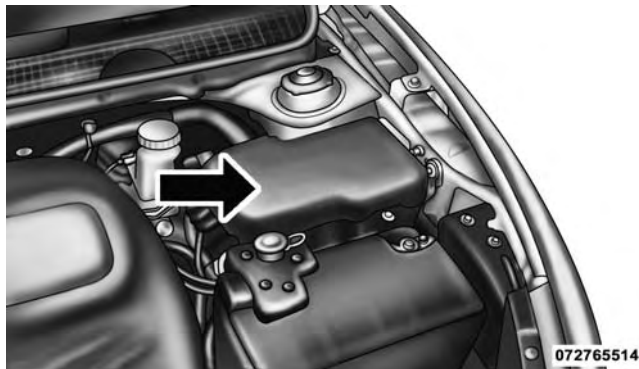

**Underhood Fuses (Power Outlet Fuses)**

- 1 — F84 Fuse 20 A Yellow Cigar Lighter
- 2 — F30 Fuse 20 A Yellow Center Console Outlet

**WARNING!**

To avoid serious injury or death:

- Only devices designed for use in this type of outlet should be inserted into any 12 Volt outlet.
- Do not touch with wet hands.
- Close the lid when not in use and while driving the vehicle.
- If this outlet is mishandled, it may cause an electric shock and failure.

**CAUTION!**

- Many accessories that can be plugged in draw power from the vehicle's battery, even when not in use (i.e., cellular phones, etc.). Eventually, if plugged in long enough, the vehicle's battery will discharge sufficiently to degrade battery life and/or prevent the engine from starting.
- Accessories that draw higher power (i.e., coolers, vacuum cleaners, lights, etc.), will degrade the battery even more quickly. Only use these intermittently and with greater caution.

*(Continued)*

**CAUTION! (Continued)**

- After the use of high power draw accessories, or long periods of the vehicle not being started (with accessories still plugged in), the vehicle must be driven a sufficient length of time to allow the alternator to recharge the vehicle's battery.
- Power outlets are designed for accessory plugs only. Do not hang any type of accessory or accessory bracket from the plug. Improper use of the power outlet can cause damage.

## CUPHOLDERS

### Front Seat Cupholders

The cupholders are located in the center console forward of the armrest between the front seats.

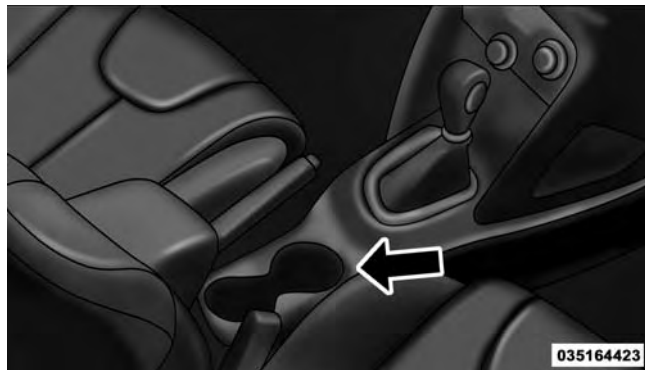

Front Cupholders

### Rear Seat Cupholders

The rear seat cupholders are located in the center armrest between the rear seats. The cupholders are positioned forward in the armrest and side-by-side to provide convenient access to beverage cans or bottles while maintaining a resting place for the rear occupant's elbows.

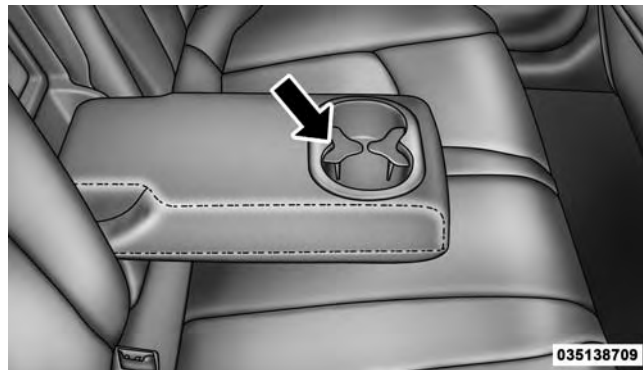

Rear Seat Cupholders

## STORAGE

### Glove Compartment

The glove compartment is located on the passenger side of the instrument panel. Pull on the release handle to open the glove compartment.



Glove Compartment



Opened Glove Compartment

### Console Features

An open storage area, or cubby bin, is located in the center console forward of the shift lever.

## 292 UNDERSTANDING THE FEATURES OF YOUR VEHICLE

There is a storage compartment located under the center console armrest. In addition, the 12 Volt power outlet, USB and Aux jack are located here.



Center Console

Pull upward on the release handle, located on the front of the armrest, to open the storage compartment.

### **WARNING!**

**Do not operate this vehicle with a console compartment lid in the open position. Driving with the console compartment lid open may result in injury in a collision.**

## Door Storage

The door panels contain storage areas.

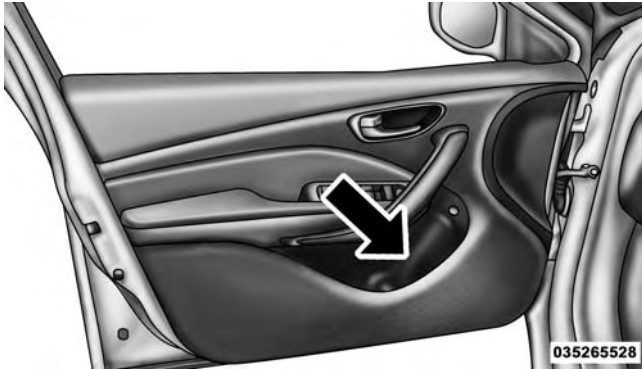

Front Door Trim Storage



Rear Door Trim Storage

### Passenger Seat Storage — If Equipped

Some models may be equipped with storage under the front passenger seat cushion. Pull upward on the seat cushion loop to open the storage compartment.

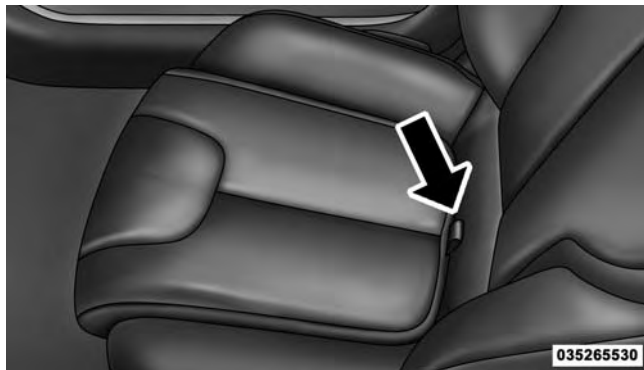

Passenger Seat Cushion Loop

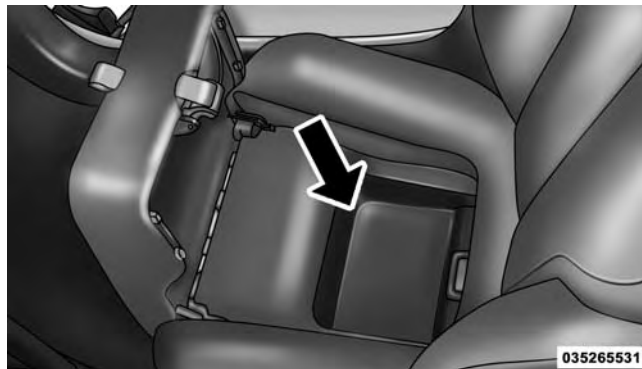

Passenger Seat Cushion Storage Compartment



### Rear Seat Armrest Storage — If Equipped

For rear passengers there is a storage bin located in the armrest. Lift upward on the latch to open the storage compartment.

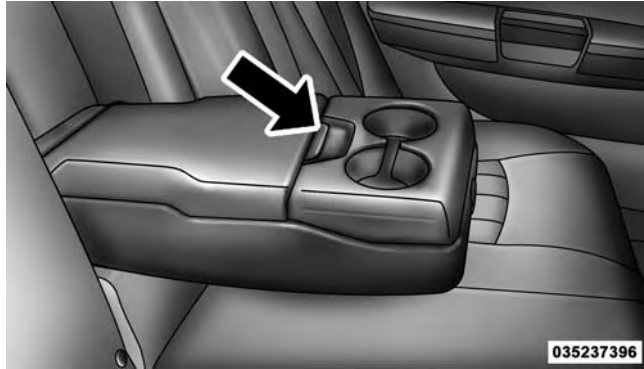

Rear Armrest Storage

### CARGO AREA FEATURES

#### Cargo Area — 60/40 Split-Folding Rear Seat — If Equipped

The 60/40 split-folding rear seat provides cargo-carrying versatility. The seatbacks fold down easily by pulling the seatback loops between the seatbacks and the bolsters. When the seats are folded down, they provide a continuous, nearly-flat extension of the load floor.

**NOTE:** The rear seatback loops can be tucked away when not in use.

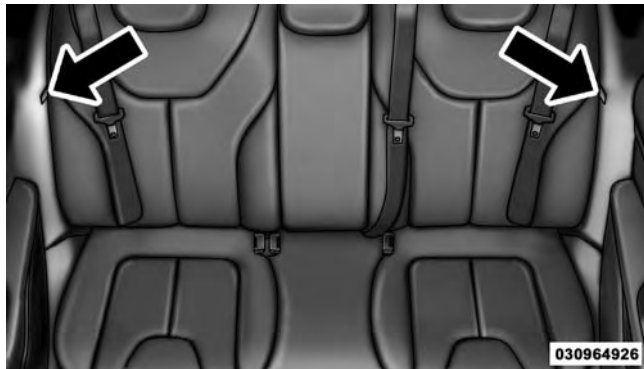

**Rear Seatback Loops**

After releasing the seatback, it can be folded forward.



**Folded Rear Seatback**

When the seatback is folded to the upright position, make sure it is latched by strongly pulling on the top of the seatback above the seat strap.

**WARNING!**

- Be certain that the seatback is securely locked into position. If the seatback is not securely locked into position, the seat will not provide the proper stability for child seats and/or passengers. An improperly latched seat could cause serious injury.
- The cargo area in the rear of the vehicle (with the rear seatbacks in the locked-up or folded down position) should not be used as a play area by children when the vehicle is in motion. They could be seriously injured in a collision. Children should be seated and using the proper restraint system.
- To help protect against personal injury, passengers should not be seated in the rear cargo area. The rear cargo space is intended for load carrying purposes only, not for passengers, who should sit in seats and use seat belts.

**WARNING!**

The weight and position of cargo and passengers can change the vehicle center of gravity and vehicle handling. To avoid loss of control resulting in personal injury, follow these guidelines for loading your vehicle:

- Always place cargo evenly on the cargo floor. Put heavier objects as low and as far forward as possible.
- Place as much cargo as possible in front of the rear axle. Too much weight or improperly placed weight over or behind the rear axle can cause the rear of the vehicle to sway.
- Do not pile luggage or cargo higher than the top of the seatback. This could impair visibility or become a dangerous projectile in a sudden stop or collision.

## Cargo Tie-Downs

The rear cargo area is equipped with cargo tie-downs, located on either side of the rear cargo area.



Cargo Tie-Downs

## Ski Pass-Through

There is a ski pass-through door located behind the rear seat armrest that allows longer items, such as snow skis, to be stored in the rear cargo area. Lower the armrest and pull downward on the latch to open the ski pass-through door.

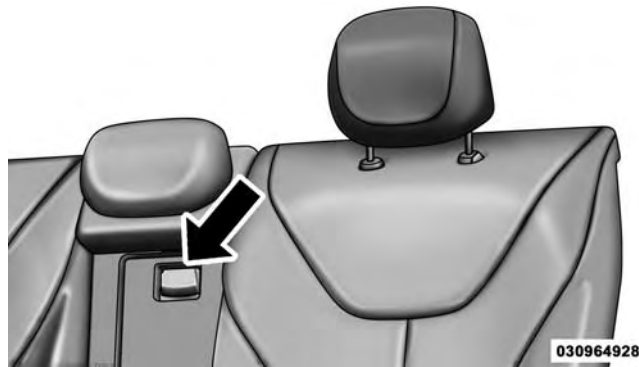

Ski Pass-Through

## REAR WINDOW FEATURES

### Rear Window Defroster



The rear window defroster button is located on the climate control. Press this button to turn on the rear window defroster and the heated outside mirrors (if equipped). An indicator in the button will illuminate when the rear window defroster is on. The rear window defroster automatically turns off after approximately 15 minutes. For an additional 15 minutes of operation, press the button a second time.

### CAUTION!

Failure to follow these cautions can cause damage to the heating elements:

- Use care when washing the inside of the rear window. Do not use abrasive window cleaners on the interior surface of the window. Use a soft cloth and a mild washing solution, wiping parallel to the heating elements. Labels can be peeled off after soaking with warm water.
- Do not use scrapers, sharp instruments, or abrasive window cleaners on the interior surface of the window.
- Keep all objects a safe distance from the window.



# UNDERSTANDING YOUR INSTRUMENT PANEL

## CONTENTS

■ INSTRUMENT PANEL FEATURES . . . . .	.304	□ Four Button EVIC — If Equipped . . . . .	.331
■ INSTRUMENT CLUSTER — BASE . . . . .	.305	■ Uconnect® SETTINGS . . . . .	.350
■ INSTRUMENT CLUSTER — PREMIUM ANALOG . . . . .	.306	□ Hard-Keys . . . . .	.350
■ INSTRUMENT CLUSTER — PREMIUM DIGITAL . . . . .	.307	□ Soft-Keys . . . . .	.351
■ INSTRUMENT CLUSTER DESCRIPTIONS . . . . .	.308	□ Customer Programmable Features — Uconnect® System 8.4 Settings . . . . .	.351
■ ELECTRONIC VEHICLE INFORMATION CENTER (EVIC) . . . . .	.321	■ Uconnect® 200 — AM/FM STEREO RADIO WITH CD PLAYER (MP3 AUX JACK) AND SiriusXM RADIO . . . . .	.365
□ Engine Oil Change Indicator System . . . . .	.323	□ Operating Instructions — Radio Mode. . . . .	.365
□ Two Button EVIC — If Equipped . . . . .	.324		

- Operation Instructions — CD MODE For CD And MP3 Audio Play . . . . . 370
- Notes On Playing MP3 Files . . . . . 373
- Enter/Browse Button (CD Mode For MP3/WMA Play). . . . . 375
- INFO Button (CD Mode For MP3/WMA Play) . . 375
- Operation Instructions — Auxiliary Mode . . . 376
- Operation Instructions — Universal Serial Bus (USB) . . . . . 376
- Security . . . . . 377
- CD PLAYER — IF EQUIPPED . . . . . 377
  - CD Player Operating Instructions . . . . . 378
- iPod®/USB/MP3 CONTROL WITH Uconnect® VOICE COMMAND — IF EQUIPPED . . . . . 378
  - Connecting The iPod® Or External USB Device . . . . . 379
  - Using This Feature. . . . . 380
  - Controlling The iPod® Or External USB Device Using Radio Buttons . . . . . 380
  - Play Mode . . . . . 381
  - List Or Browse Mode. . . . . 382
  - Bluetooth® Streaming Audio (BTSA) . . . . . 384
- STEERING WHEEL AUDIO CONTROLS . . . . . 385
  - Radio Operation . . . . . 386
  - CD Player. . . . . 386
- CD/DVD DISC MAINTENANCE . . . . . 387



- RADIO OPERATION AND MOBILE PHONES . . .387
- CLIMATE CONTROLS . . . . .388
  - Manual Heating And Air Conditioning — If Equipped . . . . .388
  - Uconnect® 8.4 Climate Controls — If Equipped . . . . .393
  - Climate Control Functions . . . . .398
  - Automatic Temperature Control (ATC) . . . . .399
  - Operating Tips . . . . .400

## INSTRUMENT PANEL FEATURES

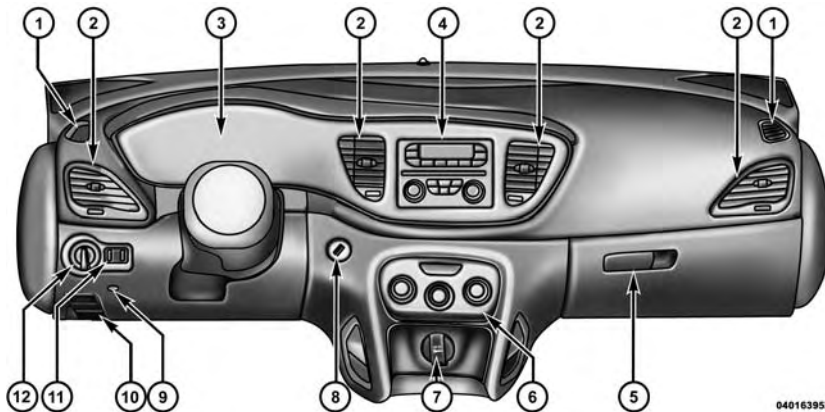

040163952

- |                            |  |                       |
|----------------------------|--|-----------------------|
| 1 — Air Demister           | 5 — Glove Compartment  | 9 — Trunk Release     |
| 2 — Outlet                 | 6 — Climate Control Hard Controls/Uconnect® System Hard Controls | 10 — Hood Release     |
| 3 — Instrument Cluster     | 7 — Power Outlet   | 11 — Dimmer Control   |
| 4 — Radio/Uconnect® System | 8 — Ignition Switch  | 12 — Headlight Switch |

INSTRUMENT CLUSTER — BASE

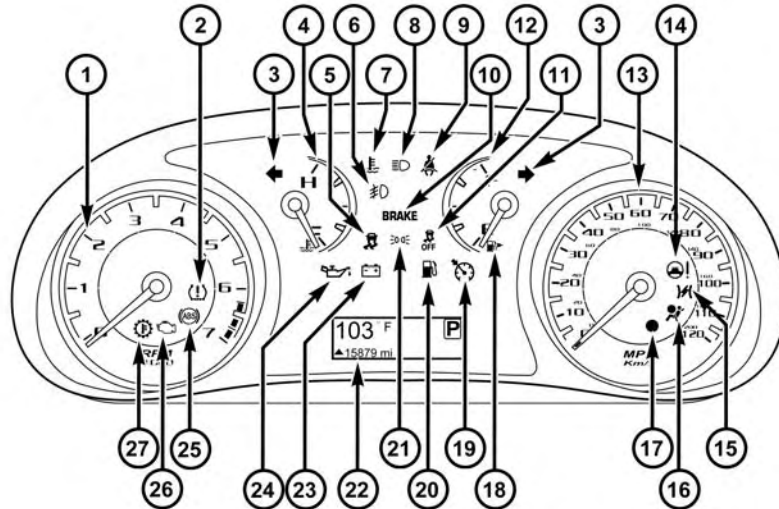

## INSTRUMENT CLUSTER — PREMIUM ANALOG

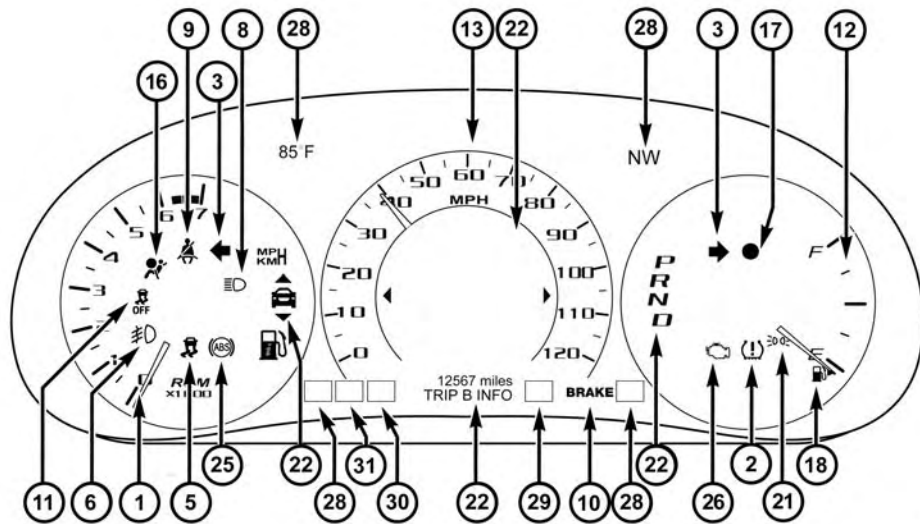

INSTRUMENT CLUSTER — PREMIUM DIGITAL

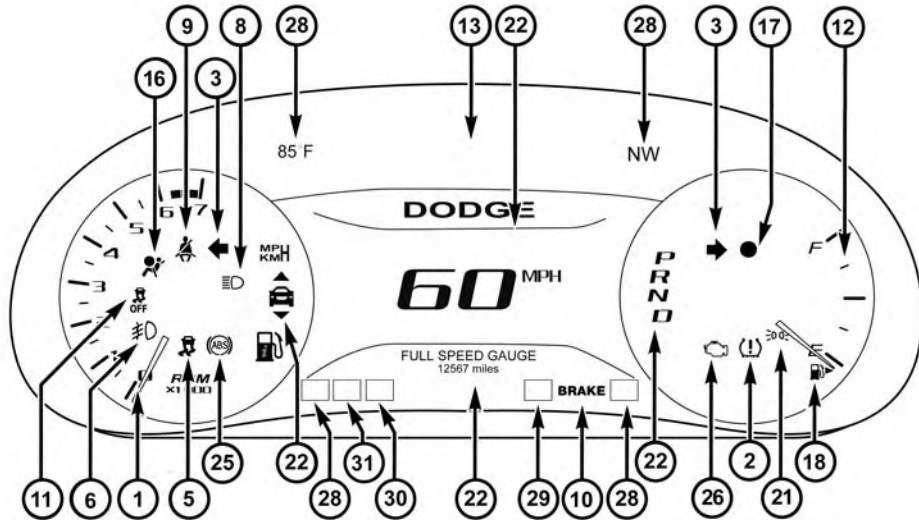

## INSTRUMENT CLUSTER DESCRIPTIONS

### 1. *Tachometer*

This gauge measures engine revolutions-per-minute (RPM x 1000).

### 2. *Tire Pressure Monitoring Telltale Light — If Equipped*



Each tire, including the spare (if provided), should be checked monthly when cold and inflated to the inflation pressure recommended by the vehicle manufacturer on the vehicle placard or tire inflation pressure label. (If your vehicle has tires of a different size than the size indicated on the vehicle placard or tire inflation pressure label, you should determine the proper tire inflation pressure for those tires.)

As an added safety feature, your vehicle has been equipped with a Tire Pressure Monitoring System (TPMS) that illuminates a low tire pressure telltale when one or more of your tires is significantly under-inflated. Accordingly, when the low tire pressure telltale illuminates, you should stop and check your tires as soon as possible, and inflate them to the proper pressure. Driving on a significantly under-inflated tire causes the tire to overheat and can lead to tire failure. Under-inflation also reduces fuel efficiency and tire tread life, and may affect the vehicle's handling and stopping ability.

Please note that the TPMS is not a substitute for proper tire maintenance, and it is the driver's responsibility to maintain correct tire pressure, even if under-inflation has not reached the level to trigger illumination of the TPMS low tire pressure telltale.

Your vehicle has also been equipped with a TPMS malfunction indicator to indicate when the system is not operating properly. The TPMS malfunction indicator is combined with the low tire pressure telltale. When the system detects a malfunction, the telltale will flash for approximately one minute and then remain continuously illuminated. This sequence will continue upon subsequent vehicle start-ups as long as the malfunction exists. When the malfunction indicator is illuminated, the system may not be able to detect or signal low tire pressure as intended. TPMS malfunctions may occur for a variety of reasons, including the installation of replacement or alternate tires or wheels on the vehicle that prevent the TPMS from functioning properly. Always check the TPMS malfunction telltale after replacing one or more tires or wheels on your vehicle, to ensure that the replacement or alternate tires and wheels allow the TPMS to continue to function properly.

### **CAUTION!**

**The TPMS has been optimized for the original equipment tires and wheels. TPMS pressures and warning have been established for the tire size equipped on your vehicle. Undesirable system operation or sensor damage may result when using replacement equipment that is not of the same size, type, and/or style. Aftermarket wheels can cause sensor damage. Do not use tire sealant from a can or balance beads if your vehicle is equipped with a TPMS, as damage to the sensors may result.**

### 3. Turn Signal Indicators



The arrow will flash with the exterior turn signal when the turn signal lever is operated.

If the vehicle electronics sense that the vehicle is driven more than 1 mile (1.6 km) with either turn signal on, a continuous chime will sound to alert you to turn the signals off. If either indicator flashes at a rapid rate, check for a defective outside light bulb.

### 4. Temperature Gauge

The temperature gauge shows engine coolant temperature. Any reading within the normal range indicates that the engine cooling system is operating satisfactorily.

The gauge pointer will likely indicate a higher temperature when driving in hot weather, up mountain grades, or when towing a trailer. It should not be allowed to exceed the upper limits of the normal operating range.

### CAUTION!

**Driving with a hot engine cooling system could damage your vehicle. If the temperature gauge reads "H" pull over and stop the vehicle. Idle the vehicle with the air conditioner turned off until the pointer drops back into the normal range. If the pointer remains on the "H" and you hear continuous chimes, turn the engine off immediately and call an authorized dealer for service.**



**WARNING!**

A hot engine cooling system is dangerous. You or others could be badly burned by steam or boiling coolant. You may want to call an authorized dealer for service if your vehicle overheats. If you decide to look under the hood yourself, see “Maintaining Your Vehicle”. Follow the warnings under the Cooling System Pressure Cap paragraph.

### 5. *Electronic Stability Control (ESC) Activation/ Malfunction Indicator Light — If Equipped*



The “ESC Activation/Malfunction Indicator Light” in the instrument cluster will come on when the ignition switch is in the ON/RUN position. It should go out with the engine running. If the “ESC Activation/Malfunction Indicator Light” comes on continuously with the engine running, a malfunction has been detected in the ESC system. If this

light remains on after several ignition cycles, and the vehicle has been driven several miles (kilometers) at speeds greater than 30 mph (48 km/h), see your authorized dealer as soon as possible to have the problem diagnosed and corrected.

**NOTE:**

- The “ESC Off Indicator Light” and the “ESC Activation/Malfunction Indicator Light” come on momentarily each time the ignition switch is placed in the ON/RUN.
- Each time the ignition is turned to ON/RUN, the ESC system will be ON, even if it was turned off previously.
- The ESC system will make buzzing or clicking sounds when it is active. This is normal; the sounds will stop when ESC becomes inactive following the maneuver that caused the ESC activation.

### 6. *Front Fog Light Indicator — If Equipped*



This indicator will illuminate when the front fog lights are on.

### 7. *Engine Temperature Warning Light*



This light warns of an overheated engine condition. If the engine coolant temperature is too high, this indicator will illuminate and a single chime will sound.

If the light turns on while driving, safely pull over and stop the vehicle. If the A/C system is on, turn it off. Also, shift the transmission into NEUTRAL and idle the vehicle. If the temperature reading does not return to normal, turn the engine off immediately and call for service. Refer to “If Your Engine Overheats” in “What To Do In Emergencies” for further information.

For vehicles equipped with a premium cluster this indicator will display in the Electronic Vehicle Information

Center (EVIC). Refer to “Electronic Vehicle Information Center (EVIC) — If Equipped” for further information.

### 8. *High Beam Indicator*



This indicator shows that the high beam headlights are on. Push the multifunction lever forward to switch the headlights to high beam, and pull toward yourself (normal position) to return to low beam.

### 9. *Seat Belt Reminder Light*



When the ignition switch is placed in the ON/RUN position, this light will turn on for four to eight seconds as a bulb check. During the bulb check, if the driver’s seat belt is unbuckled, a chime will sound. After the bulb check or when driving, if the driver’s seat belt remains unbuckled, the Seat Belt Reminder Light will illuminate and the chime will sound. Refer to “Occupant Restraints” in “Things To Know Before Starting Your Vehicle” for further information.

## 10. Brake Warning Light

### **BRAKE**

This light monitors various brake functions, including brake fluid level and parking brake application. If the brake light turns on it may indicate that the parking brake is applied, that the brake fluid level is low, or that there is a problem with the anti-lock brake system reservoir.

If the light remains on when the parking brake has been disengaged, and the fluid level is at the full mark on the master cylinder reservoir, it indicates a possible brake hydraulic system malfunction or that a problem with the Brake Booster has been detected by the Anti-Lock Brake System (ABS)/Electronic Stability Control (ESC) system. In this case, the light will remain on until the condition has been corrected. If the problem is related to the brake booster, the ABS pump will run when applying the brake and a brake pedal pulsation may be felt during each stop.

The dual brake system provides a reserve braking capacity in the event of a failure to a portion of the hydraulic system. A leak in either half of the dual brake system is indicated by the Brake Warning Light, which will turn on when the brake fluid level in the master cylinder has dropped below a specified level.

The light will remain on until the cause is corrected.

**NOTE:** The light may flash momentarily during sharp cornering maneuvers, which change fluid level conditions. The vehicle should have service performed, and the brake fluid level checked.

If brake failure is indicated, immediate repair is necessary.

**WARNING!**

**Driving a vehicle with the red brake light on is dangerous. Part of the brake system may have failed. It will take longer to stop the vehicle. You could have a collision. Have the vehicle checked immediately.**

Vehicles equipped with the Anti-Lock Brake System (ABS), are also equipped with Electronic Brake Force Distribution (EBD). In the event of an EBD failure, the Brake Warning Light will turn on along with the ABS Light. Immediate repair to the ABS system is required.

Operation of the Brake Warning Light can be checked by turning the ignition switch from the OFF position to the ON/RUN position. The light should illuminate for approximately two seconds. The light should then turn off unless the parking brake is applied or a brake fault is detected. If the light does not illuminate, have the light inspected by an authorized dealer.

The light also will turn on when the parking brake is applied with the ignition is placed in the ON/RUN position.

**NOTE:** This light shows only that the parking brake is applied. It does not show the degree of brake application.

### *11. Electronic Stability Control (ESC) OFF Indicator Light — If Equipped*



This light indicates the Electronic Stability Control (ESC) is off.

### *12. Fuel Gauge*

The pointer shows the level of fuel in the fuel tank when the ignition is in the ON/RUN position.

### *13. Speedometer*

Indicates vehicle speed.

#### 14. Power Steering System Warning



This light is used to manage the electrical warning of the EPS (Power Steering System). Refer to “Power Steering” in “Starting and Operating” for further information.

#### 15. Electronic Throttle Control (ETC) Light



This light informs you of a problem with the Electronic Throttle Control (ETC) system. If a problem is detected, the light will come on while the engine is running. Cycle the ignition key when the vehicle has completely stopped and the shift lever is placed in the NEUTRAL position. The light should turn off. If the light remains lit with the engine running, your vehicle will usually be drivable; however, see an authorized dealer for service as soon as possible. If the light is flashing when the engine is running, immediate service is required and you may experience reduced

performance, an elevated/rough idle or engine stall and your vehicle may require towing. The light will come on when the ignition is first placed in the ON/RUN position and remain on briefly as a bulb check. If the light does not come on during starting, have the system checked by an authorized dealer.

#### 16. Air Bag Warning Light



This light will turn on for four to eight seconds as a bulb check when the ignition switch is first turned to ON/RUN. If the light is either not on during starting, stays on, or turns on while driving, have the system inspected at an authorized dealer as soon as possible. Refer to “Occupant Restraints” in “Things To Know Before Starting Your Vehicle” for further information.

### 17. Vehicle Security Light — If Equipped



This light will flash at a fast rate for approximately 15 seconds, when the vehicle security alarm is arming, and then will flash slowly until the vehicle is disarmed.

### 18. Fuel Door Reminder



The arrow in this symbol is a reminder that the Fuel Filler Door is located on the left side of the vehicle.

### 19. Electronic Speed Control Set Light



This light will turn on when the electronic speed control has been set.

### 20. Low Fuel Light



When the fuel level reaches approximately 3.0 gal (11.0 L) this light will turn on, and remain on until fuel is added.

### 21. Park/Headlight ON Indicator — If Equipped



This indicator will illuminate when the park lights or headlights are turned on.

### 22. Odometer Display/Electronic Vehicle Information Center (EVIC) Display

#### Odometer Display

The odometer display shows the total distance the vehicle has been driven.

U.S. Federal regulations require that upon transfer of vehicle ownership, the seller certify to the purchaser the correct mileage that the vehicle has been driven. If your

odometer needs to be repaired or serviced, the repair technician should leave the odometer reading the same as it was before the repair or service. If s/he cannot do so, then the odometer must be set at zero, and a sticker must be placed in the door jamb stating what the mileage was before the repair or service. It is a good idea for you to make a record of the odometer reading before the repair/service, so that you can be sure that it is properly reset, or that the door jamb sticker is accurate if the odometer must be reset at zero.

The Shift Lever Indicator is self-contained within the EVIC display. It displays the gear position of the automatic transmission.

**NOTE:** You must apply the brakes before shifting from PARK.

### Electronic Vehicle Information Center (EVIC) Display

The Electronic Vehicle Information Center (EVIC) features a driver-interactive display that is located in the

instrument cluster. For further information, refer to “Electronic Vehicle Information Center (EVIC)”.

### 23. Charging System Warning Light



This light shows the status of the electrical charging system. The light should turn on when the ignition switch is first placed in ON/RUN and remain on briefly as a bulb check. If the light stays on or turns on while driving, turn off some of the vehicle’s non-essential electrical devices (i.e., radio) or slightly increase engine speed (if at idle). If the light remains on, it means that the charging system is experiencing a problem. See your local authorized dealer to obtain service immediately.

If jump starting is required, refer to “Jump Starting Procedures” in “What To Do In Emergencies”.

### 24. Oil Pressure Warning Light



This light indicates low engine oil pressure. The light should turn on momentarily when the engine is

started. If the light turns on while driving, stop the vehicle and shut off the engine as soon as possible. A chime will sound for four minutes when this light turns on.

Do not operate the vehicle until the cause is corrected. This light does not indicate how much oil is in the engine. The engine oil level must be checked under the hood.

### 25. *Anti-Lock Brake (ABS) Light*



This light monitors the Anti-Lock Brake System (ABS). The light will turn on when the ignition switch is turned to the ON/RUN position and may stay on for as long as four seconds.

If the ABS light remains on or turns on while driving, it indicates that the Anti-Lock portion of the brake system is not functioning and that service is required. However, the conventional brake system will continue to operate normally if the BRAKE warning light is not on.

If the ABS light is on, the brake system should be serviced as soon as possible to restore the benefits of Anti-Lock brakes. If the ABS light does not turn on when the ignition switch is placed in the ON/RUN position, have the light inspected by an authorized dealer.

### 26. *Malfunction Indicator Light (MIL)*



The Malfunction Indicator Light (MIL) is part of an Onboard Diagnostic system, called OBD, that monitors engine and automatic transmission control systems. The light will illuminate when placing the ignition in ON/RUN from the OFF position, before engine start. If the bulb does not come on when turning the key from OFF to ON/RUN, have the condition checked promptly.



Certain conditions, such as poor fuel quality, etc., may illuminate the MIL after engine start. The vehicle should be serviced if the light stays on through several of your typical driving cycles. In most situations, the vehicle will drive normally and will not require towing.

### CAUTION!

Prolonged driving with the Malfunction Indicator Light (MIL) on could cause damage to the engine control system. It also could affect fuel economy and driveability. If the MIL is flashing, severe catalytic converter damage and power loss will soon occur. Immediate service is required.

### WARNING!

A malfunctioning catalytic converter, as referenced above, can reach higher temperatures than in normal operating conditions. This can cause a fire if you drive slowly or park over flammable substances such as dry plants, wood, cardboard, etc. This could result in death or serious injury to the driver, occupants or others.

4

#### 27. *Transmission Temperature Warning Light — If Equipped*



This light indicates that the transmission fluid temperature is running hot. This may occur with severe usage, such as trailer towing. If this light turns on while driving, safely pull over and stop the vehicle. Then, shift the transmission into NEUTRAL and run the engine at idle or faster until the light turns off.

**CAUTION!**

Continuous driving with the Transmission Temperature Warning Light illuminated will eventually cause severe transmission damage or transmission failure.

**WARNING!**

If you continue operating the vehicle when the Transmission Temperature Warning Light is illuminated you could cause the fluid to boil over, come in contact with hot engine or exhaust components and cause a fire.

**28. Selectable EVIC Information**

This area of the cluster will display selectable information such as compass, outside temperature, etc.). For further information, refer to “Electronic Vehicle Information Center (EVIC) — If Equipped”.

**29. Electronic Speed Control Indicator**

- **Electronic Speed Control ON Indicator**



This light will turn on when the electronic speed control is ON. For further information, refer to “Electronic Speed Control” in “Understanding The Features Of Your Vehicle.”

- **Electronic Speed Control SET Indicator**



This light will turn on when the electronic speed control is SET. For further information, refer to “Electronic Speed Control” in “Understanding The Features Of Your Vehicle.”

**30. Amber Electronic Vehicle Information Center (EVIC) Reconfigurable Telltales**

This area will show reconfigurable amber telltales (Low Fuel Telltale, Windshield Washer Fluid Low Indicator, Transmission Temperature Warning Telltale). For further information, refer to “Electronic Vehicle Information Center (EVIC)”.

### 31. Red Electronic Vehicle Information Center (EVIC) Reconfigurable Telltales

This area will show reconfigurable red telltales (Door(s) Ajar, Oil Pressure Warning Telltale, Charging System Telltale, Electronic Throttle Control (ETC) Telltale, Engine Temperature Warning Telltale, Electric Power Steering Malfunction). For further information, refer to “Electronic Vehicle Information Center (EVIC)”.

### ELECTRONIC VEHICLE INFORMATION CENTER (EVIC)

The Electronic Vehicle Information Center (EVIC) features a driver-interactive display that is located in the instrument cluster.



041064390

### Electronic Vehicle Information Center (EVIC)

- 1 — EVIC Steering Wheel Controls
- 2 — EVIC Display

The main display area will normally display the main menu or the screens of a selected feature of the main menu. The main display area also displays “pop up”

messages that consist of approximately 60 possible warning or information messages. These pop up messages fall into several categories:

- *Five Second Stored Messages*

When the appropriate conditions occur, this type of message takes control of the main display area for five seconds and then returns to the previous screen. Most of the messages of this type are then stored (as long as the condition that activated it remains active) and can be reviewed from the "Messages" main menu item. As long as there is a stored message, an "i" will be displayed in the EVIC's compass/outside temp line. Examples of this message type are "Right Front Turn Signal Lamp Out" and "Low Tire Pressure".

- *Unstored Messages*

This message type is displayed indefinitely or until the condition that activated the message is cleared. Examples

of this message type are "Turn Signal On" (if a turn signal is left on) and "Lights On" (if driver leaves the vehicle).

- *Unstored Messages Until RUN*

These messages deal primarily with the Remote Start feature. This message type is displayed until the ignition is in the RUN state. Examples of this message type are "Remote Start Aborted - Door Ajar" and "Press Brake Pedal and Push Button to Start".

- *Five Second Unstored Messages*

When the appropriate conditions occur, this type of message takes control of the main display area for five seconds and then returns to the previous screen. An example of this message type is "Automatic High Beams On".

## Engine Oil Change Indicator System

### Oil Change Required

Your vehicle is equipped with an engine oil change indicator system. The “Oil Change Required” message will flash in the EVIC display for approximately 10 seconds after a single chime has sounded, to indicate the next scheduled oil change interval. The engine oil change indicator system is duty cycle based, which means the engine oil change interval may fluctuate, dependent upon your personal driving style.

Unless reset, this message will continue to display each time you turn the ignition switch to the ON/RUN position or cycle the ignition to the ON/RUN position if equipped with Keyless Enter-N-Go™. To turn off the message temporarily, press and release the MENU button. To reset the oil change indicator system (after performing the scheduled maintenance) refer to the following procedure.

### *Vehicles Equipped With Keyless Enter-N-Go™*

1. Without pressing the brake pedal, press the ENGINE START/STOP button and place the ignition in the ON/RUN position (do not start the engine.)
2. Fully depress the accelerator pedal, slowly, three times within 10 seconds.
3. Without pressing the brake pedal, press the ENGINE START/STOP button once to return the ignition to the OFF/LOCK position.

### *Vehicles Not Equipped With Keyless Enter-N-Go™*

1. Turn the ignition switch to the ON/RUN position (do not start the engine.)
2. Fully depress the accelerator pedal, slowly, three times within 10 seconds.
3. Turn the ignition switch to the OFF/LOCK position.

**NOTE:** If the indicator message illuminates when you start the vehicle, the oil change indicator system did not reset. If necessary, repeat this procedure.

### **Two Button EVIC — If Equipped**

This system allows the driver to select a variety of useful information by pressing the switches mounted on the steering wheel. The EVIC consists of the following:

- Odometer
- Digital Vehicle Speed
- Trip Info
- Range To Empty
- Fuel Economy Info
- Cruise Control Info
- Stored Messages
- Tire Pressure
- Settings
- Units
- Language

The system allows the driver to select information by pressing the following buttons mounted on the steering wheel:



EVIC Steering Wheel Buttons (Two-Button EVIC Controls)

- **UP Arrow Button**



Press and release the UP arrow button to scroll upward through the main menus (Odometer, Digital Vehicle Speed, Trip Info, Range To Empty, Average Fuel Economy, Current Fuel Economy, Stored Messages, Settings).

- **RIGHT Arrow Button**



Press and release the RIGHT arrow button to access the sub-menu screens of a main menu item. Press and hold the RIGHT arrow button for two seconds to reset displayed/selected features that can be reset.

### Electronic Vehicle Information Center (EVIC) Messages

- Key Fob Battery Low
- Wrong Key Fob

- Key Fob Damaged
- Key In Ignition
- Left Turn Signal Out
- Right Turn Signal Out
- Turn Signal On
- Lights On
- Low Beam Headlight Out
- High Beam Headlight Out
- License Plate Light Out
- Backup Light Out
- Brake Light Out
- Parking Light Out
- Service Air Bag System
- Service Air Bag Warning Light
- Washer Fluid Low
- Parking Brake Engaged
- Brake Fluid Low
- Service Electronic Braking System
- Engine Temperature Hot
- Battery Voltage Low
- Oil Pressure Low
- Fuel Low
- Service Antilock Brake System
- Service Electronic Throttle Control
- Transmission Too Hot
- Service Power Steering



- Oil Temperature Hot
- Check Fuel Cap
- Oil Change Due
- Service Tire Pressure System
- Inflate Tire to XX
- Coolant Low
- Rain Sensor Fail
- Traction Control Off
- Engine Warming Wait To Start
- Too Cold Plug In Heater
- Cruise Off
- Cruise Ready
- Cruise Set To XXX MPH
- Cruise Set To XXX km/h
- Driver Seatbelt Unbuckled
- Passenger Seatbelt Unbuckled
- Front Seatbelts Unbuckled
- Door Open
- Doors Open
- Trunk Open
- Remote Start Aborted Fuel Low
- Remote Start Disabled Start To Reset
- Remote Start Active Key To Run
- Remote Start Aborted Door Open
- Remote Start Aborted Hood Open
- Remote Start Aborted Time Expired

- Remote Start Aborted Too Cold
- Remote Start Active Push Start Button

### EVIC Main Menu

To step to each main menu feature press and release the UP button once for each step. A step from the last item in the list will cause the first item in the feature list to be displayed. The following features are in the main menu:

- Odometer
- Outside Temperature Display
- Digital Vehicle Speed
- Trip Info
- Range To Empty
- Fuel Economy Info
- Cruise Control Info

- Stored Messages
- Tire Pressure
- Settings
- Units
- Language

**NOTE:** For features in the EVIC that can be reset (Average Fuel Economy), the EVIC prompts a reset with a RIGHT arrow button graphic and the word RESET next to it.

### Trip Info

Press and release the UP arrow button until the Trip Info icon is highlighted in the EVIC. Press and release the RIGHT arrow button to display the following three trip features in the next screen:

- Trip A

- Trip B
- Elapsed Time

Press the UP buttons to cycle through all the Trip Computer functions.

The Trip Functions mode displays the following information:

### **Trip A**

Shows the total distance traveled for Trip A since the last reset.

### **Trip B**

Shows the total distance traveled for Trip B since the last reset.

### **Elapsed Time**

Shows the total elapsed time of travel since the last reset. Elapsed time will increment when the ignition is in the ON/RUN position.

### **Resetting A Trip Info Function**

To Reset any of the three Trip Info functions, select the function you want to reset using the UP button. Push the RIGHT arrow button until the feature displays zero.

### **Range To Empty (RTE)**

Shows the estimated distance that can be traveled with the fuel remaining in the tank. This estimated distance is determined by a weighted average of the instantaneous and average fuel economy, according to the current fuel tank level. RTE cannot be reset.

**NOTE:** Significant changes in driving style or vehicle loading will greatly affect the actual drivable distance of the vehicle, regardless of the RTE display value.

When the RTE value is less than 30 miles (48 km) estimated driving distance, the RTE display will change to a text display of "LOW FUEL". This display will continue until the vehicle runs out of fuel. Adding a significant amount of fuel to the vehicle will turn off the LOW FUEL text and a new RTE value will display.

### **Average Fuel Economy**

This feature shows the average fuel economy since the last reset. When Average Fuel Economy is selected, The word "RESET>" (with right arrow) appears next to it. Pressing the RIGHT arrow button will reset Average Fuel Economy which displays "0" immediately after reset. Then, the history information will be erased, and the averaging will continue from the last fuel average reading before the reset.

### **Tire PSI**

Press and release the UP button until "Tire Pressure" is displayed.

Tire pressure information is displayed as follows:

- If tire pressure is OK for all tires, a vehicle graphic is displayed with tire pressure values in each corner or the graphic.
- If one or more tires have low pressure, Inflate Tire To XX and a vehicle graphic are displayed with tire pressure values in each corner of the graphic. Tire pressure values that are too low will be flashing.
- If the Tire Pressure System requires service, "Service TPM System" is displayed. Tire Pressure is an information only function and cannot be reset.

### **Stored Messages**



When a stored warning message is present, this icon is displayed in the lower left side of the Tire Pressure menu. This feature shows the

number of stored warning messages. Pressing the RIGHT arrow button will allow you to see what the stored messages are.

### Settings — EVIC Units And Language Selection

Displays the units used for the Outside Temperature, Average and Current Fuel Economy, Distance to Empty and Tire Pressure features. Press and Release the RIGHT arrow button to toggle units between "U.S." and "METRIC".

Press the UP arrow button until the Language is displayed, then press the Right arrow button to select English, Francais, or Espanol depending on availability.

### Four Button EVIC — If Equipped

This system allows the driver to select a variety of useful information by pressing the switches mounted on the steering wheel. The EVIC consists of the following:

- Radio Info

- Fuel Economy Info
- Screen Setup
- Digital Vehicle Speed
- Analog Vehicle Speed
- Trip A
- Trip B
- Vehicle Info
  - Tire Pressure
  - Coolant Temperature
  - Oil Temperature
  - Oil Life
- Stored Warning Messages

The system allows the driver to select information by pressing the following buttons mounted on the steering wheel:



**EVIC Steering Wheel Buttons  
(Four-Button EVIC Controls)**

- ***UP Arrow Button***



Press and release the UP arrow button to scroll upward through the main menu and sub-menus (Fuel Economy, Trip A, Trip B, Stored Messages, Screen Set Up).

- ***DOWN Arrow Button***



Press and release the DOWN arrow button to scroll downward through the main menu and sub-menus (Fuel Economy, Trip A, Trip B, Stored Messages, Screen Set Up).

• *RIGHT Arrow Button*

▷ Press and release the RIGHT arrow button to access the information screens or sub-menu screens of a main menu item. Press and hold the RIGHT arrow button for two seconds to reset displayed/selected features that can be reset.

• *LEFT Arrow Button*

◁ Press the LEFT arrow button to return to the main menu from an info screen or sub-menu item.

**Electronic Vehicle Information Center (EVIC) Displays**

The EVIC displays are located in the center portion of the cluster and consists of the follow sections:

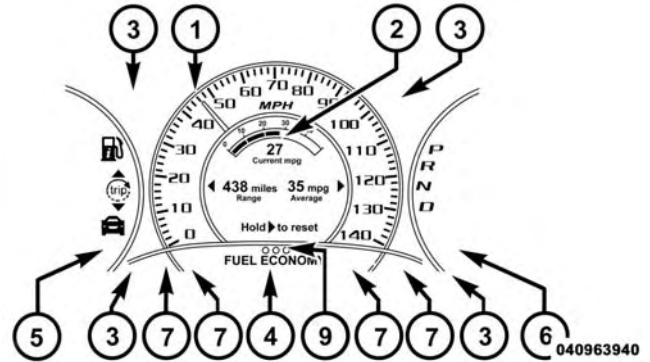

1 — Speedometer (Digital or Analog) (km/h or mph)

2 — Main Screen — The inner ring of the display will illuminate in grey under normal conditions, yellow for non critical warnings, red for critical warnings and white for on demand information.

3 — Selectable Information (Compass, Temp, Range to Empty, Trip A, Trip B, Average MPG)

4 — Menu Titles / Odometer

5 — Menu Set (Selectable Icons)

6 — Shift Lever Status (PRNDL)

7 — Reconfigurable Telltales

9 — Sub-menu Current Position — Whenever there are sub-menus available, the position within the sub-menus is shown here.

### **Electronic Vehicle Information Center (EVIC) Messages**

- Front Seatbelts Unbuckled
- Driver Seatbelt Unbuckled
- Passenger Seatbelt Unbuckled
- Service Airbag System
- Traction Control Off
- Washer Fluid Low
- Oil Pressure Low
- Oil Change Due
- Fuel Low
- Service Antilock Brake System
- Service Electronic Throttle Control



- Service Power Steering
- Cruise Off
- Cruise Ready
- Cruise Set To XXX MPH
- Tire Pressure Screen With Low Tire(s) “Inflate Tire to XX”
- Service Tire Pressure System
- Parking Brake Engaged
- Brake Fluid Low
- Service Electronic Braking System
- Engine Temperature Hot
- Battery Voltage Low
- Service Electronic Throttle Control
- Lights On
- Right Turn Signal Light Out
- Left Turn Signal Light Out
- Turn Signal On
- Vehicle Not In Park
- Key In Ignition
- Key In Ignition Lights On
- Remote Start Active Key to Run
- Remote Start Active Push Start Button
- Remote Start Aborted Fuel Low
- Remote Start Aborted Too Cold
- Remote Start Aborted Door Open
- Remote Start Aborted Hood Open

- Remote Start Aborted Trunk Open
- Remote Start Aborted Time Expired
- Remote Start Disabled Start to Reset
- Service Airbag System
- Service Airbag Warning Light
- Driver Seatbelt Unbuckled
- Passenger Seatbelt Unbuckled
- Front Seatbelts Unbuckled
- Door Open
- Doors Open
- Trunk Open
- Gear Not Available
- Shift Not Allowed
- Shift to Neutral then Drive or Reverse
- Autostick Unavailable Service Required
- Automatic Unavailable Use Autostick Service Req.
- Transmission Getting Hot Press Brake
- Trans. Hot Stop Safely Shift to Park Wait to Cool
- Transmission Cool Ready to Drive
- Service Transmission
- Service Shifter
- Engage Park Brake to Prevent Rolling
- Transmission Too Cold Idle With Engine On
- Washer Fluid Low

The Reconfigurable Telltales section is divided into the white telltales area on the right, amber telltales in the middle, and red telltales on the left.

## EVIC Amber Telltales

This area will show reconfigurable amber caution telltales. These telltales include:

- *Low Fuel Telltale*



When the fuel level reaches approximately 2.0 gal (7.5 L) this light will turn on, and remain on until fuel is added.

- *Windshield Washer Fluid Low Indicator*



This telltale will turn on to indicate the windshield washer fluid is low.

- *Transmission Temperature Warning Telltale — If Equipped*



This telltale indicates that the transmission fluid temperature is running hot. This may occur with severe usage, such as trailer towing.

If this telltale turns on, safely pull over and stop the vehicle. Then, shift the transmission into NEUTRAL and run the engine at idle or faster until the light turns off.

### CAUTION!

**Continuous driving with the Transmission Temperature Warning Telltale illuminated will eventually cause severe transmission damage or transmission failure.**

### WARNING!

**If the Transmission Temperature Warning Telltale is illuminated and you continue operating the vehicle, in some circumstances you could cause the fluid to boil over, come in contact with hot engine or exhaust components and cause a fire.**

## EVIC Red Telltales

This area will show reconfigurable red telltales. These telltales include:

- *Door Ajar*



This telltale turns on when one or more doors are ajar. The telltale will show which doors are ajar.

- *Oil Pressure Warning Telltale*



This telltale indicates low engine oil pressure. If the light turns on while driving, stop the vehicle and shut off the engine as soon as possible. A chime will sound when this light turns on.

- Do not operate the vehicle until the cause is corrected. This light does not show how much oil is in the engine. The engine oil level must be checked under the hood.

- *Charging System Telltale*



This telltale shows the status of the electrical charging system. If the telltale stays on or comes on while driving, turn off some of the vehicle's non-essential electrical devices or increase engine speed (if at idle). If the charging system telltale remains on, it means that the vehicle is experiencing a problem with the charging system. Obtain SERVICE IMMEDIATELY. See an authorized dealer.

- If jump starting is required, refer to "Jump Starting Procedures" in "What To Do In Emergencies".
- *Electronic Throttle Control (ETC) Telltale*



This telltale informs you of a problem with the Electronic Throttle Control (ETC) system. If the telltale comes on while driving, have the system checked by an authorized dealer.

- If a problem is detected, the telltale will come on while the engine is running. Cycle the ignition key when the vehicle has completely stopped and the shift lever is placed in the PARK position. The telltale should turn off.
- If the telltale remains lit with the engine running, your vehicle will usually be drivable. However, see an authorized dealer for service as soon as possible. If the telltale is flashing when the engine is running, immediate service is required. You may experience reduced performance, an elevated/rough idle or engine stall and your vehicle may require towing.
- *Engine Temperature Warning Telltale*
- If the telltale turns on while driving, safely pull over and stop the vehicle. If the A/C system is on, turn it off. Also, shift the transmission into NEUTRAL and idle the vehicle. If the temperature reading does not return to normal, turn the engine off immediately and call for service. Refer to “If Your Engine Overheats” in “What To Do In Emergencies” for more information.
- *Electric Power Steering Malfunction*



This telltale warns of an overheated engine condition. As temperatures rise and the gauge approaches **H**, this telltale will illuminate and a single chime will sound after reaching a set threshold.



This telltale is on when the Electric Power Steering is not operating and needs service.

### EVIC White Telltales

- *Electronic Speed Control ON*



This telltale will illuminate amber when the electronic speed control is ON. For further information, refer to “Electronic Speed Control” in “Understanding The Features Of Your Vehicle.”

### EVIC Green Telltales

- *Electronic Speed Control SET*



This telltale will illuminate green when the electronic speed control is SET. For further information, refer to “Electronic Speed Control” in “Understanding The Features Of Your Vehicle.”

### Full Speedometer Analog Or Digital Display Selection



Full Speedometer Analog Icon



Full Speedometer Digital Icon

Press and release the UP or DOWN arrow button until the Analog or Digital display icon is highlighted in the EVIC. Press and release the RIGHT arrow button to change the display between analog and digital.

## Vehicle Speed MPH / Km/h



Press and release the UP or DOWN arrow button until the Vehicle Speed icon is highlighted in the EVIC. Press the RIGHT arrow button to view a digital display of the current speed in MPH or km/h. Pressing the RIGHT arrow button a second time will toggle the unit of measure between mph or km/h. Press the LEFT arrow button to return to the main menu.

**NOTE:** Changing the unit of measure in the Vehicle Speed menu will not change the unit of measure in the EVIC.

## Vehicle Info (Customer Information Features)



Press and release the UP or DOWN arrow button until the Vehicle Info icon is highlighted in the EVIC. Press and release the RIGHT

arrow button and Coolant Temp will be displayed. Press the UP or DOWN arrow button to scroll through the following information sub-menus:

### Tire Pressure

Press and release the UP or DOWN arrow button until "Tire Pressure" is highlighted in the EVIC. Press and release the RIGHT arrow button and one of the following will be displayed:

- If tire pressure is OK for all tires a vehicle ICON is displayed with tire pressure values in each corner of the ICON.
- If one or more tires have low pressure, "Inflate Tire To XX" is displayed with the vehicle ICON and the tire pressure values in each corner of the ICON with the pressure value of the low tire displayed in a different color than the other tire pressure value.

- If the Tire Pressure system requires service, "Service Tire Pressure System" is displayed.



### Tire Pressure Analog Display

Tire PSI is an information only function and cannot be reset. Press and release the LEFT arrow button to return to the main menu.

Refer to "Tire Pressure Monitoring System (TPMS)" under "Starting and Operating" for further information.

### Fuel Economy



Press and release the UP or DOWN arrow button until the Fuel Economy icon is highlighted. Press the RIGHT arrow button and the next screen will display the following:

- Average Fuel Economy
- Range To Empty (RTE)
- Current Fuel Economy





Fuel Economy Analog Display



Fuel Economy Digital Display

## 344 UNDERSTANDING YOUR INSTRUMENT PANEL

The EVIC has the capability of displaying an interactive flower through the Fuel Economy sub-menu which will add one flower pedal for every 2.5 Miles Per Gallon (MPG) (1.06 km per liter (km/l) increment). Once the vehicle reached 30 MPG the EVIC will display a full flower.



Fuel Economy MPG Flower Analog Display



Fuel Economy MPG Flower Digital Display  
Average Fuel Economy

This feature shows the average fuel economy since the last reset. When Average Fuel Economy is selected, The word "RESET>" (with right arrow) appears next to it. Pressing the RIGHT arrow button will reset Average Fuel Economy which displays "0" immediately after reset.

Then, the history information will be erased, and the averaging will continue from the last fuel average reading before the reset.

### Range To Empty (RTE)

Shows the estimated distance that can be traveled with the fuel remaining in the tank. This estimated distance is determined by a weighted average of the instantaneous and average fuel economy, according to the current fuel tank level. RTE cannot be reset through the RIGHT arrow button.

**NOTE:** Significant changes in driving style or vehicle loading will greatly affect the actual drivable distance of the vehicle, regardless of the RTE displayed value.

When the RTE value is less than 30 miles (48 km) estimated driving distance, the RTE display will change to a “LOW FUEL” message. This display will continue until the vehicle runs out of fuel. Adding a significant

amount of fuel to the vehicle will turn off the “LOW FUEL” message and a new RTE value will display. Press the LEFT arrow button to return to the main menu.

### Current/Instantaneous Fuel Economy

The feature displays instantaneous fuel economy in a bar graph below the RTE, this function cannot be reset. Press the LEFT arrow button to return to the main menu.

### Trip Info



Press and release the UP or DOWN arrow button until the Trip Info icon is highlighted in the EVIC. Press and release the RIGHT arrow button to display the following three trip features in the next screen:

- Trip A
- Trip B

- Elapsed Time

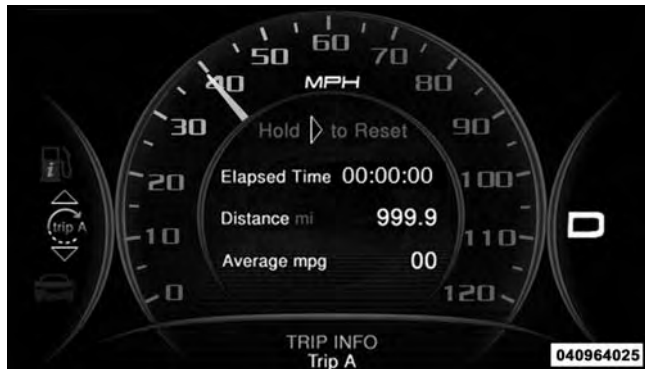

Trip Info Analog Display



Trip Info Digital Display

Press the UP/DOWN buttons to cycle through all the Trip Computer functions or press the LEFT arrow button to return to the main menu.

The Trip Functions mode displays the following information:

### **Trip A**

Shows the total distance traveled for Trip A since the last reset.

### **Trip B**

Shows the total distance traveled for Trip B since the last reset.

### **Elapsed Time**

Shows the total elapsed time of travel since the last reset. Elapsed time will increment when the ignition is in the ON/RUN position.

### **Resetting A Trip Info Function**

To Reset any of the three Trip Info functions, select the function you want to reset using the UP or DOWN buttons. Press the RIGHT arrow button until the feature displays zero.

### **Stored Messages**



Press and release the UP or DOWN arrow button until the Messages display icon is highlighted in the EVIC. This feature shows the number of stored warning messages. Pressing the RIGHT arrow button will allow you to see what the stored messages are. Press the LEFT arrow button to return to the Main Menu.

## Screen Setup



Screen Setup Display Analog Icon



Screen Setup Display Digital Icon

Press and release the UP or DOWN arrow button until the Screen Setup display icon is highlighted in the EVIC. Press and release the RIGHT arrow button to enter the Screen Setup sub-menu. The Screen Setup feature allows you to change what information is displayed in the instrument cluster as well as the location that information is displayed.

Press and release the UP or DOWN arrow button until the Screen Setup display icon is highlighted in the EVIC. Press and release the RIGHT arrow button to enter the

Screen Setup sub-menu. The Screen Setup feature allows you to change the location that information is displayed within the instrument cluster. Use the UP and DOWN buttons to highlight a screen setup location (i.e., Upper Left, Upper Right, etc.) then press the RIGHT arrow button to select the location and make changes. Press the UP and DOWN buttons to select the information you would like to display in that location (i.e., Date, Time, Outside Temp, etc.) and press the RIGHT arrow button to save the display setting. You can press the LEFT arrow button at any time to back out of a sub-menu selection.

**NOTE:** The Screen Setup items are only available at speeds less than 5 mph (8 km/h). All other menu items are not active when in Screen Setup. If the vehicle is shifted into gear, this feature is locked out and the main screen will display “Screen Setup Unavailable While In Motion”.

## Screen Setup Driver Selectable Items

- *Speedometer*

Analog 1

Analog 2

Digital 1 (default setting)

Digital 2

- *Gear Display*

Standard (PRND -/+ ) (default setting)

Single Character (D)

Word (Drive)

- *Upper Left*

None

Compass

Outside Temp (default setting)

Time

Range To Empty (RTE)

Average MPG

Current MPG

Trip A

Trip B

- *Upper Right*

None

Compass (default setting)

Outside Temp

Time

Range To Empty (RTE)

Average MPG

Current MPG

Trip A

Trip B

- *Lower Left*

None (default setting)

Compass

Outside Temp

Time

- *Lower Right*

None (default setting)

Compass

Outside Temp

Time

- *Restore To Defaults (Restores All Settings To Default Settings)*

Cancel

Okay

### **Uconnect® SETTINGS**

The Uconnect® system uses a combination of soft and hard keys located on the center of the instrument panel that allows you to access and change the customer programmable features.

### **Hard-Keys**

Hard-Keys are located below the Uconnect® system in the center of the instrument panel. In addition, there is a Scroll/Enter control knob located on the right side of the Climate Controls in the center of the instrument panel. Turn the control knob to scroll through menus and



change settings (i.e., 30, 60, 90), press the center of the control knob one or more times to select or change a setting (i.e., ON, OFF).

### Soft-Keys

Soft-Keys are accessible on the Uconnect® Touchscreen.

### Customer Programmable Features — Uconnect® System 8.4 Settings

Press the More soft-key, then press the Settings soft-key to display the menu setting screen. In this mode the Uconnect® system allows you to access programmable features that may be equipped such as Display, Clock, Safety/Assistance, Lights, Doors & Locks, Auto-On Comfort & Remote Start, Engine Off Operation, Compass Settings, Audio, Phone/Bluetooth and SIRIUS Setup.

**NOTE:** Only one touchscreen area may be selected at a time.

When making a selection, press the soft-key to enter the desired mode. Once in the desired mode press and release the preferred setting until a check-mark appears next to the setting, showing that setting has been selected.

Once the setting is complete press the Back Arrow soft-key to return to the previous menu or press the X soft-key to close out of the settings screen. Pressing the Up or Down Arrow soft-keys on the right side of the screen will allow you to toggle up or down through the available settings.

### Display

After pressing the Display soft-key the following settings will be available.

- *Display Mode*

When in this display you may select one of the auto display settings. To change Mode status, touch and release the Day, Night or Auto soft-key. Then touch the back arrow soft-key.

- *Display Brightness With Headlights ON*

When in this display, you may select the brightness with the headlights on. Adjust the brightness with the + and – setting soft-keys or by selecting any point on the scale between the + and – soft-keys. Then touch the back arrow soft-key.

- *Display Brightness With Headlights OFF*

When in this display, you may select the brightness with the headlights off. Adjust the brightness with the + and – setting soft-keys or by selecting any point on the scale between the + and – soft-keys. Then touch the back arrow soft-key.

- *Set Language*

When in this display, you may select one of three languages for all display nomenclature, including the trip functions and the navigation system (if equipped). Touch the Set Language soft-key and then touch the desired language soft-key until a check-mark appears next to the language, showing that setting has been selected. Touch the back arrow soft-key to return to the previous menu.

- *Units*

When in this display, you may select to have the EVIC, odometer, and navigation system (if equipped) changed between US and Metric units of measure. Touch US or Metric until a check-mark appears next to the setting, showing that setting has been selected. Touch the back arrow soft-key to return to the previous menu.

- *Voice Response Length*

When in this display, you may change the Voice Response Length settings. To change the Voice Response Length, touch the Brief or Detailed soft-key until a check-mark appears next to the setting, showing that setting has been selected. Touch the back arrow soft-key to return to the previous menu.

- *Touchscreen Beep*

When in this display, you may turn on or shut off the sound heard when a touch screen button (soft-key) is pressed. Touch the Touchscreen Beep soft-key until a check-mark appears next to the setting, showing that setting has been selected. Touch the back arrow soft-key to return to the previous menu.

- *Navigation Turn-By-Turn In Cluster*

When this feature is selected, the turn-by-turn directions will appear in the display as the vehicle approaches a

designated turn within a programmed route. To make your selection, touch the Navigation Turn-By-Turn In Cluster soft-key, until a check-mark appears next to the setting, showing that setting has been selected. Touch the back arrow soft-key to return to the previous menu.

### **Clock**

After pressing the Clock soft-key the following settings will be available.

- *Sync with GPS Time — If Equipped*

When in this display, you may automatically have the radio set the time. To change the Sync with GPS Time setting touch the “Sync with GPS Time” soft-key until a check-mark appears next to the setting, indicating that the setting has been selected. Touch the back arrow soft-key to return to the previous menu.

- *Set Time Hours*

When in this display, you may adjust the hours. The “Sync with GPS Time” soft-key must be unchecked. To make your selection touch the “+” or “-” soft-keys to adjust the hours up or down. Touch the back arrow soft-key to return to the previous menu or touch the “X” soft-key to close out of the settings screen.

- *Set Time Minutes*

When in this display, you may adjust the minutes. The “Sync with GPS Time” soft-key must be unchecked. To make your selection touch the “+” or “-” soft-keys to adjust the minutes up or down. Touch the back arrow soft-key to return to the previous menu or touch the “X” soft-key to close out of the settings screen.

- *Time Format*

When in this display, you may select the time format display setting. Touch the “Time Format” soft-key until a

check-mark appears next to the 12hrs or 24hrs setting, indicating that the setting has been selected. Touch the back arrow soft-key to return to the previous menu.

- *Show Time In Status Bar — If Equipped*

When in this display, you may turn on or shut off the digital clock in the status bar. To change the Show Time Status setting touch the “Show Time in Status Bar” soft-key until a check-mark appears next to setting, indicating that the setting has been selected. Touch the back arrow soft-key to return to the previous menu.

### **Safety/Assistance**

After pressing the Safety/Assistance soft-key the following settings will be available.

- *Park Assist*

The Rear Park Assist system will scan for objects behind the vehicle when the transmission shift lever is in REVERSE and the vehicle speed is less than 11 mph

(18 km/h). The system can be enabled with Sound Only, Sound and Display, or turned OFF. To change the Park Assist status, touch and release the OFF, Sound Only or Sounds and Display button. Then touch the back arrow soft-key. Refer to “ParkSense® Rear Park Assist” in “Understanding The Features Of Your Vehicle” for system function and operating information.

- *Blind Spot Alert*

When this feature is selected, the Blind Spot Alert feature can be set to Off, Lights or Lights and Chime. The Blind Spot Alert feature can be activated in “Lights” mode. When this mode is selected, the Blind Spot Monitor (BSM) system is activated and will only show a visual alert in the outside mirrors. When “Lights & Chime” mode is activated, the Blind Spot Monitor (BSM) will show a visual alert in the outside mirrors as well as an audible alert when the turn signal is on. When “Off” is

selected, the Blind Spot Monitor (BSM) system is deactivated. To change the Blind Spot Alert status, touch the Off, Lights or Lights & Chime soft-key. Then touch the back arrow soft-key.

**NOTE:** If your vehicle has experienced any damage in the area where the sensor is located, even if the fascia is not damaged, the sensor may have become misaligned. Take your vehicle to an authorized dealer to verify sensor alignment. Having a sensor that is misaligned will result in the BSM not operating to specification.

- *ParkView® Backup Camera*

Your vehicle may be equipped with the ParkView® Rear Back Up Camera that allows you to see an on-screen image of the rear surroundings of your vehicle whenever the shift lever is put into REVERSE. The image will be displayed on the radio touchscreen display along with a caution note to “check entire surroundings” across the top of the screen. After five seconds, this note will

disappear. The ParkView® camera is located on the rear of the vehicle above the rear License plate. To make your selection, touch the ParkView® Backup Camera soft-key, until a check-mark appears next to setting, showing that setting has been selected. Touch the back arrow soft-key to return to the previous menu.

- *Rain Sensing Auto Wipers*

When this feature is selected, the system will automatically activate the windshield wipers if it senses moisture on the windshield. To make your selection, touch the Rain Sensing soft-key, until a check-mark appears next to setting, showing that setting has been selected. Touch the back arrow soft-key to return to the previous menu.

## **Lights**

After pressing the Lights soft-key the following settings will be available.

- *Interior Ambient Lights*

When this feature is selected, it allows the adjustment of the brightness of the interior ambient lighting. To change the Interior Ambient Lights setting, touch the + or - soft-key to select your desired Interior Ambient Light level. Touch the back arrow soft-key to return to the previous menu.

- *Interior Accent Lighting*

When this feature is selected, the interior accent lighting surrounding the instrument panel will illuminate. To make your selection, touch the Interior Accent Lighting soft-key, until a check-mark appears next to setting, showing that setting has been selected. Touch the back arrow soft-key to return to the previous menu.

- *Headlight Illumination On Approach*

When this feature is selected, the headlights will activate and remain on for 0, 30, 60, or 90 seconds when the doors are unlocked with the Remote Keyless Entry (RKE) transmitter. To change the Illuminated Approach status, touch the + or - soft-key to select your desired time interval. Touch the back arrow soft-key to return to the previous menu.

- *Headlights With Wipers — If Equipped*

When this feature is selected, and the headlight switch is in the AUTO position, the headlights will turn on approximately 10 seconds after the wipers are turned on. The headlights will also turn off when the wipers are turned off if they were turned on by this feature. To make your selection, touch the Headlights With Wipers soft-key, until a check-mark appears next to setting, showing that setting has been selected. Touch the back arrow soft-key to return to the previous menu.

- *Auto Dim High Beams “SmartBeam™” — If Equipped*

When this feature is selected, the high beam headlights will deactivate automatically under certain conditions. To make your selection, touch the Auto High Beams soft-key, until a check-mark appears next to setting, showing that setting has been selected. Touch the back arrow soft-key to return to the previous menu. Refer to “Lights/SmartBeam™ — If Equipped” in “Understanding The Features Of Your Vehicle” for further information.

- *Daytime Running Lights*

When this feature is selected, the headlights will turn on whenever the engine is running. To make your selection, touch the Daytime Running Lights soft-key, until a check-mark appears next to setting, showing that setting has been selected. Touch the back arrow soft-key to return to the previous menu.

- *Flash Headlights With Lock*

When this feature is selected, the headlights will flash when the doors are locked or unlocked with the Remote Keyless Entry (RKE) transmitter. This feature may be selected with or without the sound horn on lock feature selected. To make your selection, touch the Flash Headlights with Lock soft-key, until a check-mark appears next to setting, showing that setting has been selected. Touch the back arrow soft-key to return to the previous menu.

### **Doors & Locks**

After pressing the Doors & Locks soft-key the following settings will be available.

- *Auto Unlock On Exit*

When this feature is selected, all doors will unlock when the vehicle is stopped and the transmission is in the PARK or NEUTRAL position and the driver's door is

opened. To make your selection, touch the Auto Unlock On Exit soft-key, until a check-mark appears next to setting, indicating that the setting has been selected. Touch the back arrow soft-key to return to the previous menu.

- *Flash Headlight With Lock*

When this feature is selected, the front and headlights will flash when the doors are locked or unlocked with the Remote Keyless Entry (RKE) transmitter. To make your selection, touch the Flash Lights With Lock soft-key, until a check-mark appears next to setting, indicating that the setting has been selected. Touch the back arrow soft-key to return to the previous menu.

- *Sound Horn With Lock*

When this feature is selected, the horn will sound when the remote start is activated. To make your selection,



touch the Sound Horn With Lock soft-key, until a check-mark appears next to setting, indicating that the setting has been selected. Touch the back arrow soft-key to return to the previous menu.

- *Sound Horn With Remote Start*

When this feature is selected, the horn will sound when the remote start is activated. To make your selection, touch the Sound Horn With Remote Start soft-key, until a check-mark appears next to setting, indicating that the setting has been selected. Touch the back arrow soft-key to return to the previous menu.

- *1st Press Of Key Fob Unlocks*

When 1st Press Of Key Fob Unlocks is selected, only the driver's door will unlock on the first press of the Remote Keyless Entry (RKE) transmitter UNLOCK button. When 1st Press Of Key Fob Unlocks is selected, you must press

the RKE transmitter UNLOCK button twice to unlock the passenger's doors. When Unlock All Doors On 1st Press is selected, all of the doors will unlock on the first press of the RKE transmitter UNLOCK button.

**NOTE:** If the vehicle is programmed 1st Press Of Key Fob Unlocks, all doors will unlock no matter which Passive Entry equipped door handle is grasped. If 1st Press Of Key Fob Unlocks is programmed, only the driver's door will unlock when the driver's door is grasped. With Passive Entry, if 1st Press Of Key Fob Unlocks is programmed touching the handle more than once will only result in the driver's door opening. If driver door first is selected, once the driver door is opened, the interior door lock/unlock switch can be used to unlock all doors (or use RKE transmitter).

- *Passive Entry*

This feature allows you to lock and unlock the vehicle's door(s) without having to press the Remote Keyless Entry (RKE) transmitter lock or unlock buttons. To make your selection, touch the Passive Entry soft-key, until a check-mark appears next to setting, indicating that the setting has been selected. Touch the back arrow soft-key to return to the previous menu. Refer to "Keyless Enter-N-Go™" in "Things To Know Before Starting Your Vehicle".

- *Interior Motion Detection Alarm*

This feature will sound the vehicles alarm when motion is detected inside the vehicle while locked. To make your selection, touch the Interior Motion Detection Alarm soft-key until a check-mark appears next to setting, indicating that the setting has been selected. Touch the back arrow soft-key to return to the previous menu.

### **Auto-On Comfort & Remote Start**

After pressing the Auto-On Comfort & Remote Start soft-key the following settings will be available.

- *Horn With Remote Start*

When this feature is selected, the horn will sound when the remote start is activated. To make your selection, touch the Sound Horn With Remote Start soft-key, until a check-mark appears next to setting, showing that setting has been selected. Touch the back arrow soft-key to return to the previous menu.

- *Auto-On Driver Heated Seat & Steering Wheel With Vehicle Start — If Equipped*

When this feature is selected the driver's heated seat and heated steering wheel will automatically turn on when temperatures are below 40° F (4.4° C). To make your selection, touch the Auto Heated Seats soft-key, until a

check-mark appears next to setting, showing that setting has been selected. Touch the back arrow soft-key to return to the previous menu.

### **Engine Off Options**

After pressing the Engine Off Options soft-key the following settings will be available.

- *Engine Off Power Delay*

When this feature is selected, the power window switches, radio, Uconnect® system (if equipped), DVD video system (if equipped), power sunroof (if equipped), and power outlets will remain active for up to 10 minutes after the ignition is cycled to OFF. Opening either front door will cancel this feature. To change the Engine Off Power Delay status touch the “0 seconds,” “45 seconds,” “5 minutes” or “10 minutes” soft-key. Then touch the back arrow soft-key.

- *Headlight Off Delay*

When this feature is selected, the driver can choose to have the headlights remain on for 0, 30, 60, or 90 seconds when exiting the vehicle. To change the Headlight Off Delay status touch the “+” or “-” soft-key to select your desired time interval. Touch the back arrow soft-key to return to the previous menu.

### **Compass Settings**

After pressing the Compass Settings soft-key the following settings will be available.

- *Variance*

Compass Variance is the difference between Magnetic North and Geographic North. To compensate for the differences the variance should be set for the zone where the vehicle is driven, per the zone map. Once properly set, the compass will automatically compensate for the differences, and provide the most accurate compass heading.

**NOTE:** Keep magnetic materials away from the top of the instrument panel, such as iPod's, Mobile Phones, Laptops and Radar Detectors. This is where the compass module is located, and it can cause interference with the compass sensor, and it may give false readings.

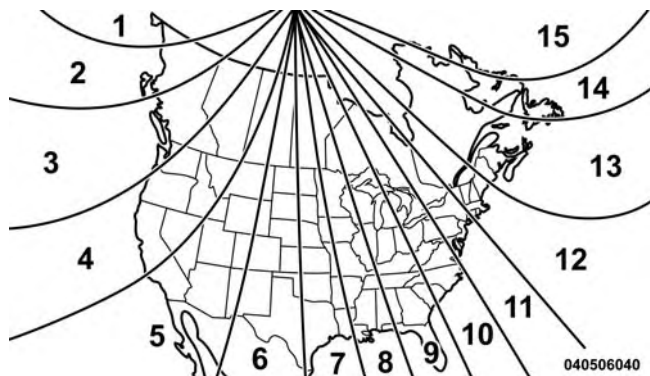

- *Perform Compass Calibration*

Touch the Calibration soft-key to change this setting. This compass is self-calibrating, which eliminates the need to manually reset the compass. When the vehicle is new, the compass may appear erratic and the EVIC will display CAL until the compass is calibrated. You may also calibrate the compass by pressing the ON soft-key and completing one or more 360-degree turns (in an area free from large metal or metallic objects) until the CAL indicator displayed in the EVIC turns off. The compass will now function normally.

### Audio

After pressing the Audio soft-key the following settings will be available.

- *Balance/Fade*

When in this display you may adjust the Balance and Fade settings.

- *Equalizer*

When in this display you may adjust the Bass, Mid and Treble settings. Adjust the settings with the + and – setting soft-keys or by selecting any point on the scale between the + and – soft-keys. Then touch the back arrow soft-key.

**NOTE:** Bass/Mid/Treble allow you to simply slide your finger up or down to change the setting as well as touch directly on the desired setting.

- *Speed Adjusted Volume*

This feature increases or decreases volume relative to vehicle speed. To change the Speed Adjusted Volume touch the Off, 1, 2 or 3 soft-key. Then touch the back arrow soft-key.

- *Music Info Cleanup*

This feature helps organize music files for optimized music navigation. To make your selection, touch the Music Info Cleanup soft-key, select On or Off followed by pressing the back arrow soft-key.

- *Surround Sound — If Equipped*

This feature provides simulated surround sound mode. To make your selection, touch the Surround Sound soft-key, select On or Off followed by pressing the back arrow soft-key.

### **Phone/Bluetooth®**

After pressing the “Phone/Bluetooth®” soft-key the following settings will be available.

- *Paired Devices*

This feature shows which phones are paired to the Phone/Bluetooth® system. For further information, refer to the Uconnect® Supplement.

### **SiriusXM Setup**

After pressing the “SIRIUS Setup” soft-key the following settings will be available.

- *Channel Skip*

SiriusXM can be programmed to designate a group of channels that are the most desirable to listen to or to exclude undesirable channels while scanning. To make your selection, touch the “Channel Skip” soft-key, select the channels you would like to skip followed by pressing the back arrow soft-key.

- *Subscription Information*

New vehicle purchasers or lessees will receive a free limited time subscription to SiriusXM Satellite Radio with your radio. Following the expiration of the free services, it will be necessary to access the information on the Subscription Information screen in order to re-subscribe.

Touch the Subscription Info soft-key to access the Subscription Information screen.

Write down the SIRIUS ID numbers for your receiver. To reactivate your service, either call the number listed on the screen or visit the provider online.

**NOTE:** SiriusXM Travel Link is a separate subscription.

## Uconnect® 200 — AM/FM STEREO RADIO WITH CD PLAYER (MP3 AUX JACK) AND SiriusXM RADIO





Uconnect® 200

### Operating Instructions — Radio Mode

**NOTE:** The ignition switch must be in the ON/RUN or ACC position to operate the radio.

#### Power Switch/Volume Control (Rotary)

Push the ON/VOLUME  control knob to turn on the radio. Push the ON/VOLUME  control knob a second time to turn off the radio.

#### Electronic Volume Control

The electronic volume control turns continuously (360 degrees) in either direction, without stopping. Turning the ON/VOLUME control knob to the right increases the volume, and to the left decreases it.

When the audio system is turned on, the sound will be set at the same volume level as last played.

### SEEK Buttons

Press and release the SEEK buttons  to search for the next listenable station in AM/FM mode. Press the right switch to seek up and the left switch to seek down. The radio will remain tuned to the new station until you make another selection. Holding either button will bypass stations without stopping until you release it.

### TIME Button

Press the TIME button to alternate display of the time and radio frequency.

### Clock Setting Procedure

1. Press and hold the TIME button until the hours are highlighted.
2. Adjust the hours by turning the right side TUNE/SCROLL control knob.
3. After adjusting the hours, press the right side ENTER/BROWSE control knob to set the minutes. The minutes will highlight.
4. Adjust the minutes using the right side TUNE/SCROLL control knob.
5. To exit, press the TIME button or press the BACK button to return to the previous menu.

The clock can also be set by pressing the MENU button. For vehicles equipped with satellite radio, press the MENU button until CLOCK appears in the display. Using the ENTER/BROWSE button select SET TIME, and then follow the above procedure, starting at Step 2.

**NOTE:** Time format has the options of 12HR or 24HR. Selecting one of these options will change the way the clock is displayed.



### **INFO Button**

Press the INFO button for an RDS station (one with call letters displayed). The radio will return a Radio Text message broadcast from an FM station (FM mode only).

### **RW/FF**

Pressing the RW (Rewind) or FF (Fast Forward) buttons causes the tuner to search for the next frequency in the direction of the arrows. This feature operates in either AM or FM frequencies.

### **TUNE Control**

Turn the rotary TUNE/SCROLL control knob clockwise to increase or counterclockwise to decrease the frequency.

### **Setting The Bass, Mid Range, Treble, Balance Or Fade**

To set the Bass, Mid Range, Treble, Balance or Fade settings press the AUDIO button to access the Audio sub-menu.

The Audio sub-menu can also be reached by pressing the MENU button until AUDIO appears in the display. Press the ENTER/BROWSE button to select the AUDIO menu and use the TUNE/SCROLL knob to highlight select Bass, Mid Range, Treble, Balance or Fade. Once the desired selection is highlighted, press the ENTER/BROWSE button to select the item and use the TUNE/SCROLL knob to adjust the setting.

Press the ENTER/BROWSE button and BASS will display. Turn the TUNE/SCROLL control knob clockwise to increase or counterclockwise to decrease the bass tones.

Press the ENTER/BROWSE button a second time and MID RANGE will display. Turn the TUNE/SCROLL control knob clockwise to increase or counterclockwise to decrease the mid-range tones.

Press the ENTER/BROWSE button a third time and TREBLE will display. Turn the TUNE/SCROLL control knob clockwise to increase or counterclockwise to decrease the treble tones.

Press the ENTER/BROWSE button a fourth time and BALANCE will display. Turn the TUNE/SCROLL control knob clockwise or counterclockwise to adjust the sound level from the Left or Right side speakers.

Press the ENTER/BROWSE button a fifth time and FADE will display. Turn the TUNE/SCROLL control knob clockwise or counterclockwise to adjust the sound level between the front and rear speakers.

Press the BACK button to exit Bass, Mid Range, Treble, Balance or Fade.

### **MENU Button**

Pressing the MENU button allows you to scroll between the setting sub-menus. Once the desired sub-menu setting is highlighted press the TUNE/SCROLL knob to select the setting. The following items are selectable:

#### Radio Mode

- **Audio** — Selecting the Audio sub-menu will allow you to adjust the Bass, Mid Range, Treble, Balance or Fade, just like pressing the Audio hard control. If the BACK button is pressed the radio will return to the Main Menu.
- **Clock** — Selecting Clock will allow you to set the clock. Adjust the hours by turning the TUNE/SCROLL control knob. After adjusting the hours, press the

ENTER/BROWSE button to set the minutes. The minutes will highlight. Adjust the minutes using the right side TUNE/SCROLL control knob. Press the ENTER/BROWSE button to save time change.

### Player Mode

- **Player Browse** — Selecting Player Browse will go to the appropriate browse menu depending on the device currently playing (will function the same as pressing the browse button while in that mode). This will only appear in the menu if the device currently playing can support these features.
- **Shuffle (SHFL)** — This function shuffles (randomizes the order of the files). This will only appear in the menu if the device currently playing can support these features.
- **Repeat (RPT)** — When Repeat is activated, the currently playing song will begin again when it ends. It will continue to cycle through the same song until repeat is turned Off. Repeat will be turned off once one for the following conditions are met: 1) The source is ejected 2) A different track list within that source is initiated 3) The REPEAT button is toggled OFF. This will only appear in the menu if the device currently playing can support these features.
- **Audio** — Selecting the Audio sub-menu will allow you to adjust the Bass, Mid Range, Treble, Balance or Fade, just like pressing the Audio hard control. If the BACK button is pressed the radio will return to the Main Menu.
- **Clock** — Selecting Clock will allow you to set the clock. Adjust the hours by turning the TUNE/SCROLL control knob. After adjusting the hours, press the ENTER/BROWSE button to set the minutes. The minutes will highlight. Adjust the minutes using the right side TUNE/SCROLL control knob. Press the ENTER/BROWSE button to save time change.

### System Info

- Selecting System Info will display the software version, serial number and SIRIUS ID.

### RADIO Button

Press the button to select either AM, FM and Satellite mode if equipped.

### Buttons 1 - 5

These buttons tune the radio to the stations that you commit to pushbutton memory AM (A, B, C), FM (A, B, C) and Satellite — 15 AM, 15 FM and 15 SAT stations.

### To Set The Pushbutton Memory

When you are receiving a station that you wish to commit to pushbutton memory, press and hold the button (1-5) you wish to lock onto this station for three seconds.

You may add a second or third station to each pushbutton by repeating the above procedure with this exception: Press the A-B-C button to select the A, B or C mode. Each button can be set for up to 3 stations in AM, FM and Sat. This allows a total of 15 AM, 15 FM and 15 SAT stations to be stored into pushbutton memory.

### Player Button

Pressing the Player button will allow you to switch from AM/FM modes to Player mode (CD, USB/iPOD®, AUX, Bluetooth®).

### Operation Instructions — CD MODE For CD And MP3 Audio Play

#### NOTE:

- The ignition switch must be in the ON/RUN or ACC position to operate the radio.

- This radio is capable of playing compact discs (CD), recordable compact discs (CD-R), rewritable compact discs (CD-RW), compact discs with MP3 tracks and multisession compact discs with CD and MP3 tracks.

### Inserting Compact Disc(s)

Gently insert one CD into the CD player with the CD label facing up. The CD will automatically be pulled into the CD player and the CD icon will illuminate on the radio display. If a CD does not go into the slot more than 1.0 in (2.5 cm), a disc may already be loaded and must be ejected before a new disc can be loaded.

If you insert a disc with the ignition ON/RUN and the radio ON, the unit will switch from radio to CD mode and begin to play when you insert the disc. The display will show the track number, and index time in minutes and seconds. Play will begin at the start of track 1.

### CAUTION!

**This CD player will accept 4-3/4 in (12 cm) discs only. The use of other sized discs may damage the CD player mechanism.**

### EJECT Button — Ejecting A CD



Press the EJECT button to eject the CD.

If you have ejected a disc and have not removed it within 10 seconds, it will be reloaded. If the CD is not removed, the radio will reinsert the CD but will not play it.

A disc can be ejected with the radio and ignition OFF.

### **SEEK Button**

Press the right SEEK button for the next selection on the CD. Press the left SEEK button to return to the beginning of the current selection, or return to the beginning of the previous selection if the CD is within the first second of the current selection. Pressing and holding the SEEK button will allow faster scrolling through the tracks in CD and MP3 modes.

### **TIME Button**

Press this button to change the display from a large CD playing time display to a small CD playing time display.

### **RW/FF**

Press and hold FF (Fast Forward) and the CD player will begin to fast forward until FF is released or RW or another CD button is pressed. The RW (Reverse) button works in a similar manner.

### **Shuffle (SHFL) And Repeat (RPT)**

This feature plays the selections on the compact disc in random order to provide an interesting change of pace. Press the MENU button to display the Player menu. Use the TUNE/SCROLL knob to scroll to the Shuffle or Repeat sub-menu. Once the Shuffle or Repeat sub-menu setting is highlighted press the ENTER/BROWSE button to select the setting and turn it on or off.

Shuffle and Repeat cannot be active at the same time. If one is selected while the other is currently active the currently active one will be changed to OFF. These settings will be dependent of the current source. If shuffle is on in iPod®, moving to CD will not have shuffle On unless it was previously set to On.

Press the right SEEK button to move to the next randomly selected track.

## Notes On Playing MP3 Files

The radio can play MP3 files; however, acceptable MP3 file recording media and formats are limited. When writing MP3 files, pay attention to the following restrictions.

### Supported Media (Disc Types)

The MP3 file recording media supported by the radio are CDDA, CD-R, CD-RW, MP3, WMA and CDDA+MP3.

### Supported Medium Formats (File Systems)

The medium formats supported by the radio are ISO 9660 Level 1 and Level 2 and includes the Joliet extension. When reading discs recorded using formats other than ISO 9660 Level 1 and Level 2, the radio may fail to read files properly and may be unable to play the file normally. UDF and Apple HFS formats are not supported.

The radio uses the following limits for file systems:

- Maximum number of folder levels: 8
- Maximum number of files: 255
- Maximum number of folders. (The radio display of file names and folder names is limited. For large numbers of files and/or folders, the radio may be unable to display the file name and folder name, and will assign a number instead. With a maximum number of files, exceeding 20 folders will result in this display. With 200 files, exceeding 50 folders will result in this display.)
- Maximum number of characters in file/folder names:
  - Level 1: 12 (including a separator "." and a three-character extension)
  - Level 2: 31 (including a separator "." and a three-character extension)

Multisession disc formats are supported by the radio. Multisession discs may contain combinations of normal CD audio tracks and computer files (including MP3 files). Discs created with an option such as "keep disc open after writing" are most likely multisession discs. The use of multisession for CD audio or MP3 playback may result in longer disc loading times.

### Supported MP3 File Formats

The radio will recognize only files with the \*.MP3 extension as MP3 files. Non-MP3 files named with the \*.MP3 extension may cause playback problems. The radio is designed to recognize the file as an invalid MP3 and will not play the file.

When using the MP3 encoder to compress audio data to an MP3 file, the bit rate and sampling frequencies in the following table are supported. In addition, variable bit rates (VBR) are also supported. The majority of MP3 files

use a 44.1 kHz sampling rate and a 192, 160, 128, 96 or VBR bit rates.

MPEG Specification	Sampling Frequency (kHz)	Bit Rate (kbps)
MPEG-1 Audio Layer 3	48, 44.1, 32	320, 256, 224, 192, 160, 128, 112, 96, 80, 64, 56, 48, 40, 32
MPEG-2 Audio Layer 3	24, 22.05, 16	160, 128, 144, 112, 96, 80, 64, 56, 48, 40, 32, 24, 16, 8

ID3 Tag information for artist, song title, and album title are supported for version 1 ID3 tags. ID3 version 2 is not supported by the radios.

Playlist files are not supported. MP3 Pro files are not supported.



## Playback Of MP3 Files

When a medium containing MP3 data is loaded, the radio checks all files on the medium. If the medium contains a lot of folders or files, the radio will take more time to start playing the MP3 files.

Loading times for playback of MP3 files may be affected by the following:

- Media - CD-RW media may take longer to load than CD-R media
- Medium formats - Multisession discs may take longer to load than non-multisession discs
- Number of files and folders - Loading times will increase with more files and folders

To increase the speed of disc loading, it is recommended to use CD-R media and single-session discs. To create a single-session disc, enable the "Disc at Once" option before writing to the disc.

## Enter/Browse Button (CD Mode For MP3/WMA Play)

Pressing the Enter/Browse button will bring up a list of all folders on the disc. Scrolling up or down the list is done by turning the TUNE/SCROLL control knob. Selecting a folder by pressing the ENTER/BROWSE button will begin playing the files contained in that folder (or the next folder in sequence if the selection does not contain playable files).

The folder list will time out after five seconds.

## INFO Button (CD Mode For MP3/WMA Play)

Pressing the INFO button repeatedly will scroll through the following TAG information: Song Title, Artist, File Name, and Folder Name (if available).

Press the INFO button once more to return to "elapsed time" priority mode.

Press and hold the INFO button for three seconds or more and the radio will display song titles for each file.

Press and hold the INFO button again for three seconds to return to "elapsed time" display.

### Operation Instructions — Auxiliary Mode

The auxiliary (AUX) jack is an audio input jack which allows the user to plug in a portable device such as an MP3 player and utilize the vehicle's audio system to amplify the source and play through the vehicle speakers.

Pressing the PLAYER button will change the mode to auxiliary device if the AUX jack is connected.

#### NOTE:

- The head unit will have no control of the AUX device. You can only control the volume on the head unit. No information about the song will be displayed.

- The AUX device must be turned on and the device's volume set to the proper level. If the AUX audio is not loud enough, turn the device's volume up. If the AUX audio sounds distorted, turn the device's volume down and radio volume up.

### Operation Instructions — Universal Serial Bus (USB)

The USB audio input allows the user to plug in a flash drive and utilize the vehicle's audio system to amplify the source and play through the vehicle speakers.

Pressing the PLAYER button will change the mode to USB when an iPod® or external USB drive is connected.

Pressing the ENTER/BROWSE button while in USB mode will bring up a list of available categories within the USB. The categories will consist of: Playlists, Artist, Album, Genre, Audiobooks, Podcasts and all Songs.. Browsing through the categories will function the same as iPod® browse. USB will not have folder browsing.

If the USB connected does not have any audio files and the user selects USB as the device to play audio the screen will display, “No audio files found.” This message is to be displayed for all devices that do not have audio files when connected and selected.

### Security

If this radio is installed in a vehicle that does not have a matching Vehicle Identification Number (VIN) an Security code will need to be entered by the dealer.

### CD PLAYER — IF EQUIPPED

The single disc CD player is located in the center console.

#### NOTE:

- The ignition switch must be in the ON or ACC position before the CD player will operate.

- The CD Player is part of the radio for the Uconnect® 200.



CD Player

## CD Player Operating Instructions

### Loading

To insert disc into the player, follow the instructions shown:

1. Gently insert the disc with the label facing the rear of the vehicle while the light below the loading slot is illuminated. The disc will automatically be pulled into the CD player.
2. Upon insertion, the disc will begin to play, and the light below the loading slot will turn off.

### EJECT (EJT) Button

If there is a disc in the CD player, press the EJT button and the disc will eject. If you do not remove the disc within 10 seconds, it will be reloaded.

### Uconnect® — If Equipped

If equipped with Uconnect® 8.4, refer to the Uconnect® 8.4 manual for further information.

### iPod®/USB/MP3 CONTROL WITH Uconnect® VOICE COMMAND — IF EQUIPPED

This feature allows an iPod® or external USB device to be plugged into the USB port.

iPod® control supports Mini, 4G, Photo, Nano, 5G iPod® and iPhone® devices. Some iPod® software versions may not fully support the iPod® control features. Please visit Apple's website for software updates.

If equipped with Uconnect® 8.4, refer to the Uconnect® User's Manual for further details on iPod®, USB, and MP3 usage.

## Connecting The iPod® Or External USB Device

Use the connection cable to connect an iPod® or external USB device to the vehicle's USB/AUX connector port which is located in the center console.



Center Console USB/AUX Connector Port



**Center Console USB/AUX Connector Port Cable Routing**  
**NOTE:** The center console will have a position where the iPod® or consumer electronic audio device cable can be routed through without damaging the cable when closing the lid. A factory cut out space for the cable to be routed may be located in the base of the center console on either the front or side. This allows routing of the cable

without damaging it while closing the lid. If a cut out is not available in the center console base, route the cable away from the lid latch and in a place that will allow the lid to close without damaging the cable.

Once the audio device is connected and synchronized to the vehicle's iPod®/USB/MP3 control system (iPod® or external USB device may take a few minutes to connect), the audio device starts charging and is ready for use by pressing radio switches, as described below.

**NOTE:** If the audio device battery is completely discharged, it may not communicate with the iPod®/USB/MP3 control system until a minimum charge is attained. Leaving the audio device connected to the iPod®/USB/MP3 control system may charge it to the required level.

## Using This Feature

By using an iPod® cable, or an external USB device to connect to the USB port:

- The audio device can be played on the vehicle's sound system, providing metadata (artist, track title, album, etc.) information on the radio display.
- The audio device can be controlled using the radio buttons to Play, Browse, and List the iPod® contents.
- The audio device battery charges when plugged into the USB/AUX connector (if supported by the specific audio device).

## Controlling The iPod® Or External USB Device Using Radio Buttons

To get into the iPod®/USB/MP3 control mode and access a connected audio device, either press the "AUX" button on the radio faceplate or press the VR button and say "USB" or "Switch to USB." Once in the iPod®/USB/

MP3 control mode, audio tracks (if available from audio device) start playing over the vehicle's audio system.

### Play Mode

When switched to iPod®/USB/MP3 control mode, the iPod® or external USB device automatically starts Play mode. In Play mode, the following buttons on the radio faceplate may be used to control the iPod® or external USB device and display data:

- Use the TUNE/SCROLL control knob to select the next or previous track.
  - Turning it clockwise (forward) by one click, while playing a track, skips to the next track or press the VR button and say "Next Track."
  - Turning it counterclockwise (backward) by one click, will jump to the previous track in the list or press the VR button and say "Previous Track"
- Jump backward in the current track by pressing and holding the << **RW** button. Holding the << **RW** button long enough will jump to the beginning of the current track.
- Jump forward in the current track by pressing and holding the **FF>>** button.
- A single press backward << **RW** or forward **FF>>** will jump backward or forward respectively, for five seconds.
- Use the << **SEEK** button during play mode to jump to the start of the current track. Pressing the **SEEK>>** button during play mode will jump to the next track in the list, or press the VR button and say "Next or Previous Track."
- While a track is playing, press the **INFO** button to see the associated metadata (artist, track title, album, etc.) for that track. Pressing the **INFO** button again jumps

to the next screen of data for that track. Once all screens have been viewed, the last **INFO** button press will go back to the play mode screen on the radio.

- Pressing the **REPEAT** button will change the audio device mode to repeat the current playing track or press the VR button and say "Repeat ON" or "Repeat Off."
- Press the **SHUFFLE** button to play the selections on the USB/iPod® device in random order to provide an interesting change of pace. To stop Shuffle Mode, press the **SHUFFLE** button again. To turn **SHUFFLE** On/Off with Voice Commands, press the  VR button, wait for the beep, and say "Shuffle On" or "Shuffle Off."

### List Or Browse Mode

During Play mode, pressing any of the buttons described below, will bring up Browse mode. List mode enables scrolling through the list of menus and tracks on the audio device.

In Browse mode, the radio **PRESET** buttons are used as shortcuts to the following lists on the iPod® or external USB device.

- Preset 1 – Playlists
- Preset 2 – Artists
- Preset 3 – Albums
- Preset 4 – Genres
- Preset 5 – Audiobooks
- Pressing a PRESET button will display the current list on the top line and the first item in that list on the second line.



- To exit Browse mode without making a selection, press the same **PRESET** button again to go back to **Play mode**.
- **Browse** button: The **Browse** button will display the top level menu of the iPod® or external USB device. Press and then turn the **TUNE/SCROLL** control knob to list the top-menu item to be selected and press the **TUNE/SCROLL** control knob to select. This will display the next sub-menu list item on the audio device, then follow the same steps to go to the desired track in that list. Not all iPod® or external USB device sub-menu levels are available on this system.
- **A-B-C** button: For all player devices, pressing the **A-B-C** button while browsing will present an ABC jump feature. The system will show the available first letters of the item being browsed. If letters do not have items they will not be shown, “\_” will be shown in their place. After selecting a letter you will be taken to

the first item of that letter within the entire list. When a browse subcategory is selected and contains no contents, “No items found” will be displayed on the screen. This message times out after three seconds, and will take you back to the submenu you were previously in.

#### CAUTION!

- **Leaving the iPod® or external USB device (or any supported device) anywhere in the vehicle in extreme heat or cold can alter the operation or damage the device. Follow the device manufacturer’s guidelines.**
- **Placing items on the iPod® or external USB device, or connections to the iPod® or external USB device in the vehicle, can cause damage to the device and/or to the connectors.**

**WARNING!**

**Do not plug in or remove the iPod® or external USB device while driving. Failure to follow this warning could result in an accident.**

**Bluetooth® Streaming Audio (BTSA)**

Music can be streamed from your cellular phone to the Uconnect® phone system.

**Controlling BTSA Using Radio Buttons**

To enter BTSA mode, press either "AUX" button on the radio or press the VR button and say "Bluetooth Streaming Audio."

**Play Mode**

When switched to BTSA mode, some audio devices can start playing music over the vehicle's audio system, but some devices require the music to be initiated on the

device first, then it will get streamed to the Uconnect® phone system. Seven devices can be paired to the Uconnect® phone system, but just one can be selected and played.

**Selecting A Different Audio Device**

1. Press the PHONE button to begin.
2. After the "Ready" prompt and following the beep, say "Setup", then say "Select Audio Devices."
3. Say the name of the audio device or ask the Uconnect® phone system to list the audio devices.

**Next Track**

Use the SEEK UP button, or press the VR button on the radio and say "Next Track," to jump to the next music track on your cellular phone.

## Previous Track

Use the SEEK DOWN button, or press the VR button on the radio and say “Previous Track,” to jump to the previous music track on your cellular phone.

## Browse

Browsing is not available on a Bluetooth® Streaming Audio (BTSA) device. Only the current song that is playing will display info.

## STEERING WHEEL AUDIO CONTROLS

The remote sound system controls are located on the rear surface of the steering wheel. Reach behind the wheel to access the switches.



045035190

**Remote Sound Controls (Back View Of Steering Wheel)**  
The right-hand control is a rocker-type switch with a pushbutton in the center and controls the volume and mode of the sound system. Pressing the top of the rocker switch will increase the volume, and pressing the bottom of the rocker switch will decrease the volume.

Pressing the center button will make the radio switch between the various modes available (AM/FM/SAT/CD/HDD/AUX, etc.).

The left-hand control is a rocker-type switch with a pushbutton in the center. The function of the left-hand control is different depending on which mode you are in.

The following describes the left-hand control operation in each mode.

### **Radio Operation**

Pressing the top of the switch will “Seek” up for the next listenable station and pressing the bottom of the switch will “Seek” down for the next listenable station.

The button located in the center of the left-hand control will tune to the next preset station that you have programmed in the radio preset pushbutton.

### **CD Player**

Pressing the top of the switch once will go to the next track on the CD. Pressing the bottom of the switch once will go to the beginning of the current track, or to the beginning of the previous track if it is within eight seconds after the current track begins to play.

If you press the switch up or down twice, it plays the second track; three times, it will play the third, etc.

The center button on the left side rocker switch has no function for a single-disc CD player. However, when a multiple-disc CD player is equipped on the vehicle, the center button will select the next available CD in the player.

## CD/DVD DISC MAINTENANCE

To keep a CD/DVD in good condition, take the following precautions:

1. Handle the disc by its edge; avoid touching the surface.
2. If the disc is stained, clean the surface with a soft cloth, wiping from center to edge.
3. Do not apply paper or tape to the disc; avoid scratching the disc.
4. Do not use solvents such as benzene, thinner, cleaners, or anti-static sprays.
5. Store the disc in its case after playing.
6. Do not expose the disc to direct sunlight.
7. Do not store the disc where temperatures may become too high.

**NOTE:** If you experience difficulty in playing a particular disc, it may be damaged (e.g., scratched, reflective coating removed, a hair, moisture or dew on the disc) oversized, or have protection encoding. Try a known good disc before considering disc player service.

## RADIO OPERATION AND MOBILE PHONES

Under certain conditions, the mobile phone being on in your vehicle can cause erratic or noisy performance from your radio. This condition may be lessened or eliminated by relocating the mobile phone antenna. This condition is not harmful to the radio. If your radio performance does not satisfactorily “clear” by the repositioning of the antenna, it is recommended that the radio volume be turned down or off during mobile phone operation when not using Uconnect® (if equipped).

## CLIMATE CONTROLS

The air conditioning and heating system is designed to make you comfortable in all types of weather. This system can be operated through either the controls on the instrument panel or through the Uconnect® 8.4 system display if equipped.

When the Uconnect® 8.4 system is in different modes (Radio, Player, Settings, More, etc.) the driver and passenger temperature settings will be indicated at the top of the display.

### Manual Heating And Air Conditioning — If Equipped

The Manual Temperature Controls consist of a series of outer rotary dials and inner push knobs.



Manual Climate Controls — Hard-Keys

#### 1. Blower Control

Rotate this control to regulate the amount of air forced through the ventilation system in any mode. The blower speed increases as you move the control to the right from the “O” (OFF) position. There are seven blower speeds.

## 2. *Recirculation Control*

Pressing the Recirculation Control button will temporarily put the system in recirculation mode. This can be used when outside conditions such as smoke, odors, dust, or high humidity are present. Activating recirculation will cause the LED in the control button to illuminate.

### NOTE:

- Continuous use of the Recirculation mode may make the inside air stuffy and window fogging may occur. Extended use of this mode is not recommended.
- The use of the Recirculation mode in cold or damp weather will cause windows to fog on the inside, because of moisture buildup inside the vehicle. Select the outside air position for maximum defogging.
- The A/C will engage automatically to prevent fogging when the recirculation button is pressed and the mode control is set to panel or Bi-Level.

- Recirculated air is not allowed in Defrost modes. If the Recirculation button is pressed while in this mode, the LED indicator will flash several times then go out. Recirculation will be disabled automatically if this mode is selected.
- The A/C can be deselected manually without disturbing the mode control selection.
- When the ignition switch is turned to the LOCK position, the recirculation feature will be cancelled.

## 3. *Temperature Control*

Rotate this control to regulate the temperature of the air inside the passenger compartment. Rotating the dial left into the blue area of the scale indicates cooler temperatures, while rotating right into the red area indicates warmer temperatures.

**NOTE:** If your air conditioning performance seems lower than expected, check the front of the A/C condenser located in front of the radiator for an accumulation of dirt or insects. Clean with a gentle water spray from behind the radiator and through the condenser. Fabric front fascia protectors may reduce airflow to the condenser, reducing air conditioning performance.

#### 4. *Air Conditioning Control*

Press this button to engage the Air Conditioning. A light will illuminate when the Air Conditioning system is engaged. Rotating the dial left into the blue area of the scale indicates cooler temperatures, while rotating right into the red area indicates warmer temperatures.

**NOTE:** The air conditioning compressor will not engage until the engine has been running for about 10 seconds.

- *MAX A/C*

For maximum cooling use the A/C and recirculation buttons at the same time.

- *ECONOMY MODE*

If economy mode is desired, press the A/C button to turn OFF the indicator light and the A/C compressor. Then, move the temperature control to the desired temperature and select only Panel, Bi-Level or Floor modes.

#### 5. *Mode Control (Air Direction)*

Rotate this control to choose from several patterns of air distribution. You can select either a primary mode as identified by the symbols on the control, or a blend of two of these modes. The closer the setting is to a particular symbol, the more air distribution you receive from that mode.

- *Panel*



Air is directed through the outlets in the instrument panel. These outlets can be adjusted to direct airflow.



**NOTE:** The center instrument panel outlets can be aimed so that they are directed toward the rear seat passengers for maximum airflow to the rear.

- *Bi-Level*

 Air is directed through the panel and floor outlets.

**NOTE:** For all settings, except full cold or full hot, there is a difference in temperature between the upper and lower outlets. The warmer air flows to the floor outlets. This feature gives improved comfort during sunny but cool conditions.

- *Floor*

 Air is directed through the floor outlets with a small amount flowing through the defrost and side window demist outlets.

- *Mix*



Air is directed through the floor, defrost, and side window demist outlets. This setting works best in cold or snowy conditions that require extra heat to the windshield. This setting is good for maintaining comfort while reducing moisture on the windshield.

- *Front Defrost*

Air is directed through the windshield and side window demist outlets. Use this mode with maximum blower and temperature settings for best windshield and side window defrosting.

**NOTE:** The air conditioning compressor operates in Mix, Defrost, or a blend of these modes, even if the Air Conditioning (A/C) button is not pressed. This dehumidifies the air to help dry the windshield. To improve fuel economy, use these modes only when necessary.

### 6. *Electronic Rear Window Defrost*

Press this button to turn on the rear window defroster and the heated outside mirrors (if equipped). An indicator in the button will illuminate when the rear window defroster is on. The rear window defroster automatically turns off after approximately 15 minutes. For an additional 15 minutes of operation, press the button a second time.

#### **NOTE:**

- You can turn off the heated mirror feature at anytime by pressing the rear window defroster switch a second time.
- To prevent excessive battery drain, use the rear window defroster only when the engine is operating.

#### **CAUTION!**

**Failure to follow these cautions can cause damage to the heating elements:**

- Use care when washing the inside of the rear window. Do not use abrasive window cleaners on the interior surface of the window. Use a soft cloth and a mild washing solution, wiping parallel to the heating elements. Labels can be peeled off after soaking with warm water.
- Do not use scrapers, sharp instruments, or abrasive window cleaners on the interior surface of the window.
- Keep all objects a safe distance from the window.

## Uconnect® 8.4 Climate Controls — If Equipped

### Hard-Keys

The hard-keys are located below the Uconnect® 8.4 screen, in the center of the instrument panel.

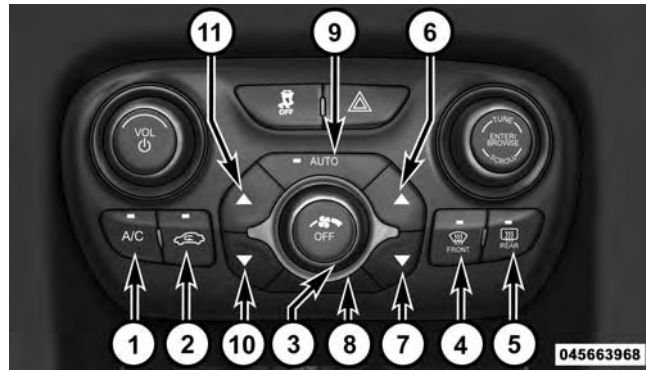

Automatic Climate Controls — Hard-Keys

### Soft-Keys

Soft-keys are accessible on the Uconnect® 8.4 system screen.

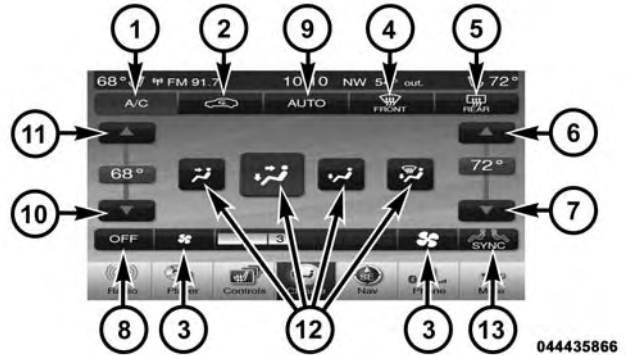

Uconnect® 8.4 Automatic Temperature Controls — Soft-Keys

## Button Descriptions (Applies To Both Hard-keys And Soft-keys)

### 1. *A/C Button*

Press and release to change the current Air Conditioning (A/C) setting, the indicator illuminates when A/C is ON. Performing this function will cause the automatic operation to switch into manual mode and the AUTO indicator will turn off.

### 2. *Recirculation Button*

Press and release to change the current setting, the indicator illuminates when ON.

### 3. *Blower Control*

Blower control is used to regulate the amount of air forced through the climate system. There are seven blower speeds available. Adjusting the blower will cause

automatic mode to switch to manual operation. The speeds can be selected using either hard-keys or soft-keys as follows:

#### **Hard-key**

The blower speed increases as you turn the control clockwise from the lowest blower setting. The blower speed decreases as you turn the knob counter-clockwise.

#### **Soft-key**

Use the small blower icon to reduce the blower setting and the large blower icon to increase the blower setting. Blower can also be selected by pressing the blower bar area between the icons.

### 4. *Front Defrost Button*

Press and release to change the current airflow setting to Defrost mode. The indicator illuminates when this feature is ON. Performing this function will cause the ATC to switch into manual mode. The blower speed may

increase when Defrost mode is selected. If the front defrost mode is turned off the climate system will return the previous setting.

### 5. Rear Defrost Button

Press and release this button to turn on the rear window defroster and the heated outside mirrors (if equipped). An indicator will illuminate when the rear window defroster is on. The rear window defroster automatically turns off after 15 minutes.

#### CAUTION!

Failure to follow these cautions can cause damage to the heating elements:

*(Continued)*

#### CAUTION! *(Continued)*

- Use care when washing the inside of the rear window. Do not use abrasive window cleaners on the interior surface of the window. Use a soft cloth and a mild washing solution, wiping parallel to the heating elements. Labels can be peeled off after soaking with warm water.
- Do not use scrapers, sharp instruments, or abrasive window cleaners on the interior surface of the window.
- Keep all objects a safe distance from the window.

### 6. Passenger Temperature Control Up Button

Provides the passenger with independent temperature control. Push the button for warmer temperature settings.

**NOTE:** Pressing this button while in Sync mode will automatically exit Sync.

### *7. Passenger Temperature Control Down Button*

Provides the passenger with independent temperature control. Push the button for cooler temperature settings.

**NOTE:** Pressing this button while in Sync mode will automatically exit Sync.

### *8. Climate Control OFF Button*

Press and release this button to turn the Climate Control ON/OFF.

### *9. AUTO Operation Button*

Automatically controls the interior cabin temperature by adjusting airflow distribution and amount. Performing this function will cause the ATC to switch between manual mode and automatic modes. Refer to “Automatic Operation” for more information.

### *10. Driver Temperature Control Down Button*

Provides the driver with independent temperature control. Push the button for cooler temperature settings.

**NOTE:** In Sync mode, this button will also automatically adjust the passenger temperature setting at the same time.

### *11. Driver Temperature Control Up Button*

Provides the driver with independent temperature control. Push the button for warmer temperature settings.

**NOTE:** In Sync mode, this button will also automatically adjust the passenger temperature setting at the same time.

## 12. Modes

The airflow distribution mode can be adjusted so air comes from the instrument panel outlets, floor outlets, demist outlets and defrost outlets. The Mode settings are as follows:

- *Panel Mode*

 Air comes from the outlets in the instrument panel. Each of these outlets can be individually adjusted to direct the flow of air. The air vanes of the center outlets and outboard outlets can be moved up and down or side to side to regulate airflow direction. There is a shut off wheel located below the air vanes to shut off or adjust the amount of airflow from these outlets.

- *Bi-Level Mode*

 Air comes from the instrument panel outlets and floor outlets. A slight amount of air is directed through the defrost and side window demister outlets.

**NOTE:** BI-LEVEL mode is designed under comfort conditions to provide cooler air out of the panel outlets and warmer air from the floor outlets.

- *Floor Mode*

 Air comes from the floor outlets. A slight amount of air is directed through the defrost and side window demister outlets.

- *Mix Mode*

 Air comes from the floor, defrost and side window demist outlets. This mode works best in cold or snowy conditions.

- *Defrost Mode*

Air comes from the windshield and side window demist outlets. Use Defrost mode with maximum temperature settings for best windshield and side window defrosting and defogging. When the defrost mode is selected, the blower level may increase.

### 13. SYNC

Press the Sync soft-key to toggle the Sync feature On/Off. The Sync indicator is illuminated when this feature is enabled. Sync is used to synchronize the passenger temperature setting with the driver temperature setting. Changing the passenger temperature setting while in Sync will automatically exit this feature.

### Climate Control Functions

#### A/C (Air Conditioning)

The Air Conditioning (A/C) button allows the operator to manually activate or deactivate the air conditioning system. When the air conditioning system is turned on, cool dehumidified air will flow through the outlets into the cabin. For improved fuel economy, press the A/C button to turn off the air conditioning and manually adjust the blower and airflow mode settings.

#### NOTE:

- If fog or mist appears on the windshield or side glass, select Defrost mode and increase blower speed.
- If your air conditioning performance seems lower than expected, check the front of the A/C condenser (located in front of the radiator), for an accumulation of dirt or insects. Clean with a gentle water spray from behind the radiator and through the condenser. Fabric front fascia protectors may reduce airflow to the condenser, reducing air conditioning performance.

#### Recirculation



When outside air contains smoke, odors, or high humidity, or if rapid cooling is desired, you may wish to recirculate interior air by pressing the Recirculation control button. The recirculation indicator will illuminate when this button is



selected. Push the button a second time to turn off the Recirculation mode and allow outside air into the vehicle.

**NOTE:** In cold weather, use of Recirculation mode may lead to excessive window fogging. The recirculation feature may be unavailable (soft-key button greyed out). The Recirculation mode is not allowed in Defrost mode to improve window clearing operation. Recirculation will be disabled automatically if this mode is selected. Attempting to use Recirculation while in this mode will cause the LED in the control button to blink and then turn off.

## **Automatic Temperature Control (ATC)**

### **Automatic Operation**

1. Press the AUTO hard-key or soft-key button (4) on the Automatic Temperature Control (ATC) Panel.

2. Next, adjust the temperature you would like the system to maintain by adjusting the driver and passenger temperature hard or soft control buttons (7, 8, 13, 14). Once the desired temperature is displayed, the system will achieve and automatically maintain that comfort level.
3. When the system is set up for your comfort level, it is not necessary to change the settings. You will experience the greatest efficiency by simply allowing the system to function automatically.

### **NOTE:**

- It is not necessary to move the temperature settings for cold or hot vehicles. The system automatically adjusts the temperature, mode, and blower speed to provide comfort as quickly as possible.

- The temperature can be displayed in U.S. or Metric units by selecting the US/M customer-programmable feature. Refer to the “Uconnect® System Settings” in this section of the manual.

To provide you with maximum comfort in the Automatic mode, during cold start-ups the blower fan will remain on low until the engine warms up. The blower will increase in speed and transition into Auto mode.

### Manual Operation Override

The system allows for manual selection of blower speed, air distribution mode, A/C status and recirculation control.

The blower fan speed can be set to any fixed speed by adjusting the blower control. The fan will now operate at a fixed speed until additional speeds are selected. This allows the front occupants to control the volume of air circulated in the vehicle and cancel the Auto mode.

The operator can also select the direction of the airflow by selecting one of the available mode settings. A/C operation and Recirculation control can also be manually selected in Manual operation.

### Operating Tips

**NOTE:** Refer to the chart at the end of this section for suggested control settings for various weather conditions.

### Summer Operation

The engine cooling system must be protected with a high-quality antifreeze coolant to provide proper corrosion protection and to protect against engine overheating. A solution of 50% OAT (Organic Additive Technology) coolant that meets the requirements of Chrysler Material Standard MS-12106 and 50% water is recommended. Refer to “Maintenance Procedures” in “Maintaining Your Vehicle” for proper coolant selection.

## Winter Operation

Use of the air Recirculation mode during Winter months is not recommended because it may cause window fogging.

## Vacation Storage

Any time you store your vehicle or keep it out of service (i.e., vacation) for two weeks or more, run the air conditioning system at idle for about five minutes in the fresh air and high blower setting. This will ensure adequate system lubrication to minimize the possibility of compressor damage when the system is started again.

## Window Fogging

Interior fogging on the windshield can be quickly removed by turning the mode selector to Defrost. The

Defrost/Floor mode can be used to maintain a clear windshield and provide sufficient heating. If side window fogging becomes objectionable, increase blower speed to improve airflow and clearing of the side windows. Vehicle windows tend to fog on the inside in mild but rainy or humid weather.

### NOTE:

- Recirculate without A/C should not be used for long periods, as fogging may occur.
- Automatic Temperature Controls (ATC) will automatically adjust the climate control settings to reduce or eliminate window fogging on the front windshield. When this occurs, recirculation will be unavailable.

### **Outside Air Intake**

Make sure the air intake, located directly in front of the windshield, is free of obstructions such as leaves. Leaves collected in the air intake may reduce airflow, and if they enter the plenum, they could plug the water drains. In winter months, make sure the air intake is clear of ice, slush, and snow.

### **A/C Air Filter**

The climate control system filters outside air containing dust, pollen and some odors. Strong odors cannot be totally filtered out. Refer to “Maintenance Procedures” in “Maintaining Your Vehicle” for filter replacement instructions.

# STARTING AND OPERATING

## CONTENTS

■ STARTING PROCEDURES . . . . .	.407	□ Turbocharger “Cool Down” — If Equipped . .	.411
□ Manual Transmission — If Equipped . . . . .	.407	■ ENGINE BLOCK HEATER — IF EQUIPPED . .	.412
□ Automatic Transmission — If Equipped . . . .	.408	■ MANUAL TRANSMISSION — IF EQUIPPED . .	.412
□ Keyless Enter-N-Go . . . . .	.408	□ Shifting. . . . .	.413
□ Normal Starting. . . . .	.408	□ Downshifting . . . . .	.414
□ Extreme Cold Weather (Below -20°F or -29°C) . . . . .	.410	■ AUTOMATIC TRANSMISSION — IF EQUIPPED . . . . .	.416
□ Extended Park Starting. . . . .	.410	□ Key Ignition Park Interlock. . . . .	.418
□ If Engine Fails To Start . . . . .	.411	□ Brake/Transmission Shift Interlock System . .	.418
□ After Starting . . . . .	.411		

- Six-Speed Automatic Transmission  
(1.4L Turbo Engine Only — DDCT) . . . . . 419
- Six-Speed Automatic Transmission  
(2.0L And 2.4L Engine Only — 6F24) . . . . . 430
- AUTOSTICK® . . . . . 438
  - Operation . . . . . 438
- DRIVING ON SLIPPERY SURFACES . . . . . 440
  - Acceleration . . . . . 440
  - Traction . . . . . 440
- DRIVING THROUGH WATER . . . . . 441
  - Flowing/Rising Water . . . . . 441
  - Shallow Standing Water . . . . . 441
- PARKING BRAKE . . . . . 442
- POWER STEERING . . . . . 445
- ELECTRONIC BRAKE CONTROL SYSTEM . . . . . 446
  - Anti-Lock Brake System (ABS) . . . . . 447
  - Brake Assist System (BAS) . . . . . 449
  - Traction Control System (TCS) . . . . . 450
  - Electronic Roll Mitigation (ERM) . . . . . 450
  - Trailer Sway Control (TSC) . . . . . 451
  - Hill Start Assist (HSA) . . . . . 452
  - Electronic Stability Control (ESC) . . . . . 455
- TIRE SAFETY INFORMATION . . . . . 458
  - Tire Markings . . . . . 458
  - Tire Identification Number (TIN) . . . . . 462
  - Tire Terminology And Definitions . . . . . 463
  - Tire Loading And Tire Pressure . . . . . 464

<ul style="list-style-type: none"> <li>■ TIRES — GENERAL INFORMATION . . . . . 469                     <ul style="list-style-type: none"> <li>□ Tire Pressure . . . . . 469</li> <li>□ Tire Inflation Pressures . . . . . 470</li> <li>□ Tire Pressures For High Speed Operation . . . 472</li> <li>□ Radial Ply Tires . . . . . 472</li> <li>□ Tire Types . . . . . 473</li> <li>□ Run Flat Tires — If Equipped . . . . . 474</li> <li>□ Spare Tires — If Equipped . . . . . 475</li> <li>□ Tire Spinning . . . . . 477</li> <li>□ Tread Wear Indicators . . . . . 478</li> <li>□ Life Of Tire . . . . . 478</li> <li>□ Replacement Tires . . . . . 479</li> </ul> </li> <li>■ TIRE CHAINS (TRACTION DEVICES) . . . . . 480</li> </ul>	<ul style="list-style-type: none"> <li>■ TIRE ROTATION RECOMMENDATIONS . . . . . 482</li> <li>■ TIRE PRESSURE MONITORING SYSTEM (TPMS) . . . . . 483                     <ul style="list-style-type: none"> <li>□ Base System . . . . . 486</li> <li>□ Premium System — If Equipped . . . . . 489</li> <li>□ General Information . . . . . 492</li> </ul> </li> <li>■ FUEL REQUIREMENTS . . . . . 492                     <ul style="list-style-type: none"> <li>□ 1.4L Turbo Engine . . . . . 492</li> <li>□ 2.0L And 2.4L Engine . . . . . 492</li> <li>□ Reformulated Gasoline . . . . . 493</li> <li>□ Gasoline/Oxygenate Blends . . . . . 493</li> <li>□ E-85 Usage In Non-Flex Fuel Vehicles . . . . . 494</li> <li>□ MMT In Gasoline . . . . . 495</li> </ul> </li> </ul>
---	--

## 406 STARTING AND OPERATING

- Materials Added To Fuel . . . . .495
- Fuel System Cautions. . . . .495
- Carbon Monoxide Warnings . . . . .496
- ADDING FUEL . . . . .497
  - Fuel Filler Cap (Gas Cap) . . . . .497
- VEHICLE LOADING . . . . .500
  - Vehicle Certification Label . . . . .500
- TRAILER TOWING . . . . .502
  - Common Towing Definitions . . . . .502
  - Trailer Hitch Classification . . . . .505
  - Trailer Towing Weights  
(Maximum Trailer Weight Ratings) . . . . .506
  - Trailer And Tongue Weight . . . . .507
  - Towing Requirements . . . . .508
  - Towing Tips . . . . .513
- RECREATIONAL TOWING (BEHIND  
MOTORHOME, ETC.) . . . . .515
  - Towing This Vehicle Behind Another Vehicle . .515



## STARTING PROCEDURES

Before starting your vehicle, adjust your seat, adjust both inside and outside mirrors, and fasten your seat belts.

### WARNING!

- When leaving the vehicle, always remove the Key Fob from the ignition and lock your vehicle.
- Never leave children alone in a vehicle, or with access to an unlocked vehicle.
- Allowing children to be in a vehicle unattended is dangerous for a number of reasons. A child or others could be seriously or fatally injured. Children should be warned not to touch the parking brake, brake pedal or the shift lever.

*(Continued)*

### WARNING! *(Continued)*

- Do not leave the Key Fob in or near the vehicle (or in a location accessible to children), and do not leave the ignition of a vehicle equipped with Keyless Enter-N-Go™ in the ACC or ON/RUN mode. A child could operate power windows, other controls, or move the vehicle.

### Manual Transmission — If Equipped

Before starting the engine fully apply the parking brake, press the clutch pedal to the floor, and place the shift lever in NEUTRAL.

#### NOTE:

- The engine will not start unless the clutch pedal is pressed to the floor.

- If the key will not turn and the steering wheel is locked, rotate the wheel in either direction to relieve pressure on the locking mechanism and then turn the key.

### Automatic Transmission — If Equipped

The shift lever must be in the PARK or NEUTRAL position before you can start the engine. Depress the brake pedal before shifting to any driving gear.

**NOTE:** You must press the brake pedal before shifting out of PARK.

### Keyless Enter-N-Go



This feature allows the driver to operate the ignition switch with the push of a button, as long as the Remote Keyless Entry (RKE) transmitter is in the passenger compartment.

### Normal Starting

#### Using The ENGINE START/STOP Button

1. The transmission must be in PARK or NEUTRAL.
2. Press and hold the brake pedal while pressing the ENGINE START/STOP button once.
3. The system takes over and attempts to start the vehicle. If the vehicle fails to start, the starter will disengage automatically after 10 seconds.
4. If you wish to stop the cranking of the engine prior to the engine starting, press the button again.

**NOTE:** Normal starting of either a cold or a warm engine is obtained without pumping or pressing the accelerator pedal.

## To Turn Off The Engine Using ENGINE START/STOP Button

1. Place the shift lever/shift selector in PARK, then press and release the ENGINE START/STOP button.
2. The ignition switch will return to the OFF position.
3. If the shift lever/shift selector is not in PARK, the ENGINE START/STOP button must be held for two seconds or three short presses in a row with the vehicle speed above 5 mph (8 km/h) before the engine will shut off. The ignition switch position will remain in the ACC position until the shift lever/shift selector is in PARK and the button is pressed twice to the OFF position. If the shift lever/shift selector is not in PARK and the ENGINE START/STOP button is pressed once, the EVIC (if equipped) will display a "Vehicle Not In Park" message and the engine will remain running. Never leave a vehicle out of the PARK position, or it could roll.

**NOTE:** If the ignition switch is left in the ACC or RUN (engine not running) position and the transmission is in PARK, the system will automatically time out after 30 minutes of inactivity and the ignition will switch to the OFF position.

## ENGINE START/STOP Button Functions — With Driver's Foot OFF The Brake Pedal (In PARK Or NEUTRAL Position)

The ENGINE START/STOP button operates similar to an ignition switch. It has four positions, OFF, ACC, RUN and START. To change the ignition positions without starting the vehicle and use the accessories follow these steps:

- Starting with the ignition in the OFF position,
- Press the ENGINE START/STOP button once to place the ignition to the ACC position (EVIC will display "ACC"),

- Press the ENGINE START/STOP button a second time to place the ignition to the RUN position (EVIC will display “ON/RUN”),
- Press the ENGINE START/STOP button a third time to return the ignition to the OFF position (EVIC will display “OFF”).

### **Extreme Cold Weather (Below $-20^{\circ}\text{F}$ or $-29^{\circ}\text{C}$ )**

To ensure reliable starting under extreme cold conditions an externally powered electric block heater (available from your authorized dealer) is required for the 1.4L Turbo engine below  $-20^{\circ}\text{F}$  ( $-29^{\circ}\text{C}$ ) and for the 2.4L engine below  $-29^{\circ}\text{F}$  ( $-34^{\circ}\text{C}$ ) and is recommended for the 2.0L engine and 2.4L engine below  $-20^{\circ}\text{F}$  ( $-29^{\circ}\text{C}$ ).

### **Extended Park Starting**

**NOTE:** Extended Park condition occurs when the vehicle has not been started or driven for at least 35 days.

1. Install a battery charger or jumper cables to the battery to ensure a full battery charge during the crank cycle.
2. Place the ignition in the START position and release it when the engine starts.
3. If the engine fails to start within 10 seconds, place the ignition to the STOP (OFF/LOCK) position, wait five seconds to allow the starter to cool, then repeat the Extended Park Starting procedure.
4. If the engine fails to start after 8 attempts, allow the starter to cool for at least 10 minutes, then repeat the procedure.

## If Engine Fails To Start

If the engine fails to start after you have followed the “Normal Starting” or “Extreme Cold Weather” procedures, it may be flooded. Push the accelerator pedal all the way to the floor and hold it there. Crank the engine for no more than 15 seconds. This should clear any excess fuel in case the engine is flooded. Leave the ignition key in the ON position, release the accelerator pedal and repeat the “Normal Starting” procedure.

### WARNING!

**Never pour fuel or other flammable liquid into the throttle body air inlet opening in an attempt to start the vehicle. This could result in flash fire causing serious personal injury.**

### CAUTION!

**To prevent damage to the starter, do not continuously crank the engine for more than 25 seconds at a time. Wait 60 seconds before trying again.**

## After Starting

The idle speed will automatically decrease as the engine warms up.

## Turbocharger “Cool Down” — If Equipped

This vehicle is equipped with an after-run pump to cool the turbocharger after the engine is shut off. Depending on the type of driving and the amount of cargo, the pump will run for up to 10 minutes after the engine has been shut off to circulate coolant through the turbocharger. Although the pump is rubber-mounted for quiet operation, it is normal to hear it running during this time.

**ENGINE BLOCK HEATER — IF EQUIPPED**

The engine block heater warms the engine, and permits quicker starts in cold weather. Connect the cord to a standard 110-115 Volt AC electrical outlet with a grounded, three-wire extension cord.

The engine block heater must be plugged in at least one hour to have an adequate warming effect on the engine.

**WARNING!**

Remember to disconnect the engine block heater cord before driving. Damage to the 110-115 Volt electrical cord could cause electrocution.

**MANUAL TRANSMISSION — IF EQUIPPED****WARNING!**

You or others could be injured if you leave the vehicle unattended without having the parking brake fully applied. The parking brake should always be applied when the driver is not in the vehicle, especially on an incline.

**CAUTION!**

Never drive with your foot resting on the clutch pedal, or attempt to hold the vehicle on a hill with the clutch pedal partially engaged, as this will cause abnormal wear on the clutch.

**NOTE:** During cold weather, you may experience increased effort in shifting until the transmission fluid warms up. This is normal.

## Shifting

Fully press the clutch pedal before shifting gears. As you release the clutch pedal, lightly press the accelerator pedal.

You should always use first gear when starting from a standing position.

## Recommended Vehicle Shift Speeds

To utilize your manual transmission efficiently for both fuel economy and performance, it should be upshifted as listed in recommended shift speed chart. Shift at the vehicle speeds listed for acceleration. When heavily loaded or pulling a trailer these recommended up-shift speeds may not apply.

Manual Transmission Shift Speeds in MPH (KM/H)					
All Engines	Engine Speeds	2 to 3	3 to 4	4 to 5	5 to 6
	Accel.	24 (39)	34 (55)	47 (76)	56 (90)
	Cruise	19 (31)	27 (43)	37 (60)	41 (66)

## Downshifting

Moving from a high gear down to a lower gear is recommended to preserve brakes when driving down steep hills. In addition, downshifting at the right time provides better acceleration when you desire to resume speed. Downshift progressively. Do not skip gears to avoid overspeeding the engine and clutch.

### WARNING!

Do not downshift for additional engine braking on a slippery surface. The drive wheels could lose their grip, and the vehicle could skid.

### CAUTION!

- **Skipping gears and downshifting into lower gears at higher vehicle speeds can damage the engine and clutch systems. Any attempt to shift into lower gear with clutch pedal depressed may result damage to the clutch system. Shifting into lower gear and releasing the clutch may result in engine damage.**
- **When descending a hill, be very careful to downshift one gear at a time to prevent overspeeding the engine which can cause engine damage, and/or clutch damage, even if the clutch pedal is pressed. If transfer case is in low range the vehicle speeds to cause engine and clutch damage are significantly lower.**

*(Continued)*



**CAUTION!** *(Continued)*

- Failure to follow the maximum recommended downshifting speeds may cause the engine damage and/or damage the clutch, even if the clutch pedal is pressed.
- Descending a hill in low range with clutch pedal depressed could result in clutch damage

## Maximum Recommended Downshift Speeds

**CAUTION!**

Failure to follow the maximum recommended downshifting speeds may cause the engine to overspeed and/or damage the clutch disc, even if the clutch pedal is pressed.

## Manual Transmission Shift Speeds in MPH (KM/H)

Gear Selection	6 to 5	5 to 4	4 to 3	3 to 2	2 to 1
Maximum Speed	80 (129)	70 (113)	50 (81)	30 (48)	15 (24)

**CAUTION!**

If you skip a gear while downshifting or downshift at too high of a vehicle speed, these conditions may cause the engine to overspeed if too low of a gear is selected and the clutch pedal is released. Damage to the clutch and the transmission can result from skipping a gear while downshifting or downshifting at too high of a vehicle speed even if the clutch pedal is held pressed (i.e., not released).

**AUTOMATIC TRANSMISSION — IF EQUIPPED****CAUTION!**

Damage to the transmission may occur if the following precautions are not observed:

- Shift into PARK only after the vehicle has come to a complete stop.
- Shift into or out of REVERSE only after the vehicle has come to a complete stop and the engine is at idle speed.
- Do not shift between PARK, REVERSE, NEUTRAL, or DRIVE when the engine is above idle speed.
- Before shifting into any gear, make sure your foot is firmly pressing the brake pedal.

**NOTE:** You must press and hold the brake pedal while shifting out of PARK.

**WARNING!**

- Unintended movement of a vehicle could injure those in or near the vehicle. As with all vehicles, you should never exit a vehicle while the engine is running. Before exiting a vehicle, always apply the parking brake, shift the transmission into PARK, turn the engine OFF, and remove the Key Fob. When the ignition is in the OFF position, the transmission is locked in PARK, securing the vehicle against unwanted movement.

*(Continued)*

**WARNING! (Continued)**

- It is dangerous to shift out of PARK or NEUTRAL if the engine speed is higher than idle speed. If your foot is not firmly pressing the brake pedal, the vehicle could accelerate quickly forward or in reverse. You could lose control of the vehicle and hit someone or something. Only shift into gear when the engine is idling normally and your foot is firmly pressing the brake pedal.
- When leaving the vehicle, always remove the Key Fob and lock your vehicle.
- Never leave children alone in a vehicle, or with access to an unlocked vehicle. Allowing children to be in a vehicle unattended is dangerous for a number of reasons. A child or others could be seriously or fatally injured.

*(Continued)*

**WARNING! (Continued)**

- Children should be warned not to touch the parking brake, brake pedal or the shift lever.
- Do not leave the Key Fob in or near the vehicle (or in a location accessible to children), and do not leave the ignition of a vehicle equipped with Keyless Enter-N-Go™ in the ACC or ON/RUN mode. A child could operate power windows, other controls, or move the vehicle.

**Key Ignition Park Interlock**

This vehicle is equipped with a Key Ignition Park Interlock which requires the transmission to be in PARK before the ignition switch can be turned to the full OFF (key removal) position. The key fob can only be removed from the ignition when the ignition is in the full OFF position, and the transmission is locked in PARK whenever the ignition switch is in the full OFF position.

**NOTE:** If a malfunction occurs, the system will trap the key fob in the ignition switch to warn you that this safety feature is inoperable. The engine can be started and stopped but the key fob cannot be removed until you obtain service.

**Brake/Transmission Shift Interlock System**

This vehicle is equipped with a Brake Transmission Shift Interlock System (BTSI) that holds the shift lever in PARK unless the brakes are applied. To shift the transmission out of PARK, the ignition switch must be turned to the ON/RUN position (engine running or not) and the brake pedal must be pressed.

### **Six-Speed Automatic Transmission (1.4L Turbo Engine Only — DDCT)**

The transmission gear position display (located in the instrument panel cluster) indicates the transmission gear range. You must press the brake pedal and the lock button on the shift lever to move the shift lever out of PARK (refer to “Brake/Transmission Shift Interlock System” in this section). To drive, press the lock button on the front of the shift lever and move the shift lever from PARK or NEUTRAL to the DRIVE position.

The electronically-controlled transmission provides a precise shift schedule. The transmission electronics are

self-calibrating; therefore, the first few shifts on a new vehicle may be somewhat abrupt. This is a normal condition, and precision shifts will develop within a few hundred miles (kilometers).

Only shift from DRIVE to PARK or REVERSE when the accelerator pedal is released and the vehicle is stopped. Be sure to keep your foot on the brake pedal when shifting between these gears.

This transmission is programmed to prevent shifting from REVERSE to DRIVE or DRIVE to REVERSE, if vehicle speed is above 6 mph (10 km/h). This safety feature helps protect your transmission from damage.

The transmission shift lever has PARK, REVERSE, NEUTRAL, DRIVE, and AutoStick® shift positions. Manual shifts can be made using the AutoStick® shift control (refer to “AutoStick®” in this section for further information). Moving the shift lever rearward (+) or forward (-) while in the AutoStick® position (beside the DRIVE position) will manually select the transmission gear, and will display the current gear in the instrument cluster as 1, 2, 3, etc.



**Shift Lever**

### **Gear Ranges**

DO NOT race the engine when shifting from PARK or NEUTRAL into another gear range.

**NOTE:** After selecting any gear range, wait a moment to allow the selected gear to engage before accelerating. This is especially important when the engine is cold.

### **PARK (P)**

This range supplements the parking brake by locking the transmission. The engine can be started in this range. Never attempt to use PARK while the vehicle is in motion. Apply the parking brake when leaving the vehicle in this range.

When parking on a level surface, you may shift the transmission into PARK first, and then apply the parking brake.

When parking on a hill, apply the parking brake before shifting the transmission to PARK, otherwise the load on the transmission locking mechanism may make it difficult to move the shift lever out of PARK. As an added precaution, turn the front wheels toward the curb on a

downhill grade and away from the curb on an uphill grade.

### **WARNING!**

- **Never use the PARK position as a substitute for the parking brake. Always apply the parking brake fully when parked to guard against vehicle movement and possible injury or damage.**
- **Your vehicle could move and injure you and others if it is not completely in PARK. Check by trying to move the shift lever out of PARK with the brake pedal released. Make sure the transmission is in PARK before leaving the vehicle.**

*(Continued)*

**WARNING! (Continued)**

- It is dangerous to shift out of PARK or NEUTRAL if the engine speed is higher than idle speed. If your foot is not firmly pressing the brake pedal, the vehicle could accelerate quickly forward or in reverse. You could lose control of the vehicle and hit someone or something. Only shift into gear when the engine is idling normally and your foot is firmly pressing the brake pedal.

*(Continued)*

**WARNING! (Continued)**

- Unintended movement of a vehicle could injure those in or near the vehicle. As with all vehicles, you should never exit a vehicle while the engine is running. Before exiting a vehicle, always apply the parking brake, shift the transmission into PARK, turn the engine OFF, and remove the Key Fob. When the ignition is in the OFF position, the transmission is locked in PARK, securing the vehicle against unwanted movement.
- When leaving the vehicle, always remove the Key Fob and lock your vehicle.

*(Continued)*



**WARNING! (Continued)**

- Never leave children alone in a vehicle, or with access to an unlocked vehicle. Allowing children to be in a vehicle unattended is dangerous for a number of reasons. A child or others could be seriously or fatally injured. Children should be warned not to touch the parking brake, brake pedal or the shift lever.
- Do not leave the Key Fob in or near the vehicle, (or in a location accessible to children) and do not leave the ignition (of a vehicle equipped with Keyless Enter-N-Go™) in the ACC or ON/RUN mode. A child could operate power windows, other controls, or move the vehicle.

**CAUTION!**

- Before moving the shift lever out of PARK, you must turn the ignition switch from the LOCK/OFF position to the ON/RUN position, and also press the brake pedal. Otherwise, damage to the shift lever could result.
- DO NOT race the engine when shifting from PARK or NEUTRAL into another gear range, as this can damage the drivetrain.

The following indicators should be used to ensure that you have engaged the transmission into the PARK position:

- When shifting into PARK, firmly move the shift lever all the way forward until it stops and is fully seated.
- Look at the transmission gear position display and verify that it indicates the PARK position.

- With brake pedal released, verify that the shift lever will not move out of PARK.

### *REVERSE (R)*

This range is for moving the vehicle backward. Shift into REVERSE only after the vehicle has come to a complete stop.

### *NEUTRAL (N)*

Use this range when the vehicle is standing for prolonged periods with the engine running. The engine may be started in this range. Apply the parking brake and shift the transmission into PARK if you must leave the vehicle.

### **WARNING!**

**Do not coast in NEUTRAL and never turn off the ignition to coast down a hill. These are unsafe practices that limit your response to changing traffic or road conditions. You might lose control of the vehicle and have a collision.**

### **CAUTION!**

**Towing the vehicle, coasting, or driving for any other reason with the transmission in NEUTRAL can cause severe transmission damage. Refer to "Recreational Towing" in "Starting And Operating" and "Towing A Disabled Vehicle" in "What To Do In Emergencies" for further information.**

### *DRIVE (D)*

This range should be used for most city and highway driving. It provides the smoothest upshifts and downshifts, and the best fuel economy. The transmission automatically upshifts through all forward gears. The DRIVE position provides optimum driving characteristics under all normal operating conditions.

To maximize fuel economy, the Dual Dry Clutch automatic transmission uses a geartrain arrangement similar to a manual transmission. Therefore, you should become familiar with some of the normal operational characteristics of the DDCT:

- During low-speed driving conditions in first gear, vehicle momentum changes may feel exaggerated in response to changes in accelerator pedal position. This behavior is normal and is similar to vehicles equipped with a manual transmission.
- At low speeds you may hear mechanical noises similar to a manual transmission as the transmission changes gears. These noises are normal and will not damage the transmission.
- Very aggressive driving may result in some clutch odor similar to a manual transmission. An active warning message will display in the Instrument Cluster if cool down actions are needed.
- When stopped on an incline, always hold the vehicle in place using the brakes. On steep inclines, Hill Start Assist (HSA) will temporarily hold the car in position when the brake pedal is released. If the accelerator pedal is not applied after a short time, the car will roll back. Either reapply the brake (to hold the vehicle) or press the accelerator to climb the hill.
- Before and after the engine is started, you may hear a hydraulic pump for a short period of time. This noise is normal and will not damage the transmission.

When frequent transmission shifting occurs (such as when operating the vehicle under heavy loading conditions, in hilly terrain, or traveling into strong head winds), use the AutoStick® shift control (refer to “AutoStick®” in this section for further information) to select a lower gear. Under these conditions, using a lower gear will improve performance and extend transmission life by reducing excessive shifting and heat buildup.

During extremely cold temperatures, the transmission will not operate if the oil temperature is -22°F (-30°C) or

below. Allow the engine to idle briefly with the transmission in PARK in order to warm the fluid. Normal operation will resume once the transmission temperature has risen to a suitable level.

### *Instrument Cluster Messages*

Messages will be displayed in the instrument cluster to alert the driver when certain unusual conditions occur. These messages are described below.

MESSAGE	DESCRIPTION
GEAR NOT AVAILABLE	In AutoStick® mode, the gear selected by the driver is not available due to a fault condition. See your authorized dealer for diagnosis and service.
SHIFT NOT ALLOWED	The gear position requested by the driver is currently blocked. This occurs if: REVERSE is requested while moving (at 6 mph [10 km/h] or faster), if DRIVE is requested while moving backwards (at 6 mph [10 km/h] or faster), or if (in AutoStick® mode) a DOWNSHIFT is requested while in 1st gear, 3rd gear or higher is requested at a stop, or a requested shift would cause engine lugging or overspeed. Make sure the vehicle is stopped before engaging DRIVE or REVERSE.
SHIFT TO NEUTRAL – THEN D or R	The transmission has shifted itself into NEUTRAL (due to a fault condition, or overheat due to excessive idling when stopped in DRIVE with the brakes released), but the shift lever remains in gear. Shift into NEUTRAL and then back into gear for continued driving. If the transmission will not re-engage, see your authorized dealer.
AUTOSTICK NOT AVAILABLE	AutoStick® mode is unavailable due to a shift lever fault. See your authorized dealer for diagnosis and service.

MESSAGE	DESCRIPTION
AUTOMATIC MODE NOT AVAILABLE	The transmission is unable to shift itself automatically, due to a fault condition. Use the AutoStick® mode to shift the transmission manually. See your authorized dealer for diagnosis and service.
REDUCE GEAR CHANGES	The transmission pump is overheating. In AutoStick® mode, try to drive in one specific gear as much as possible, avoiding frequent gear changes. In DRIVE, the transmission will automatically modify its shift schedule to reduce the number of shifts.
TRANS. GETTING HOT PRESS BRAKE	The transmission driving clutch is overheating, usually due to repeated launches in stop-and-go traffic. Pull over and allow the transmission to cool in NEUTRAL until "TRANS. COOL READY TO DRIVE" is displayed.
TRANS. HOT STOP SAFELY SHIFT TO P	The transmission driving clutch has overheated. Pull over and shift the transmission into PARK and allow the vehicle to cool until "TRANS. COOL READY TO DRIVE" is displayed.
SERVICE TRANSMIS- SION	A transmission fault has been detected. See your authorized dealer for diagnosis and service.

MESSAGE	DESCRIPTION
SERVICE SHIFTER	A shift lever fault has been detected. See your authorized dealer for diagnosis and service.
ENGAGE PARK BRAKE	The sensor that confirms PARK engagement is not functioning properly. Engage the parking brake to ensure that the vehicle will not roll when in PARK.

### *Transmission Limp Home Mode*

Transmission function is monitored electronically for abnormal conditions. If a condition is detected that could result in transmission damage, Transmission Limp Home Mode is activated. In this mode, some gears will be unavailable. The transmission will operate only in a certain select set of gears (such as 1st, 2nd, 3rd, and Reverse, or 1st, 3rd, 5th, and Reverse, or 2nd, 4th, and 6th [with no Reverse]). PARK and NEUTRAL will continue to be available. The Malfunction Indicator Light (MIL) may be illuminated. Limp Home Mode allows the vehicle to be driven to an authorized dealer for service without damaging the transmission.

In the event of a momentary problem, the transmission can be reset to regain all forward gears by performing the following steps:

1. Stop the vehicle.
2. Shift the transmission into PARK.
3. Turn the ignition switch to the OFF position.
4. Wait approximately 10 seconds.
5. Restart the engine.

6. Shift into the desired gear range. If the problem is no longer detected, the transmission will return to normal operation.

**NOTE:** Even if the transmission can be reset, we recommend that you visit your authorized dealer at your earliest possible convenience. Your authorized dealer has diagnostic equipment to determine if the problem could recur.

If the transmission cannot be reset, authorized dealer service is required.

### **Six-Speed Automatic Transmission (2.0L And 2.4L Engine Only — 6F24)**

The transmission gear position display (located in the instrument panel cluster) indicates the transmission gear range. You must press the brake pedal and the lock button on the shift lever to move the shift lever out of

PARK (refer to “Brake/Transmission Shift Interlock System” in this section). To drive, press the lock button on the front of the shift lever and move the shift lever from PARK or NEUTRAL to the DRIVE position.

The electronically-controlled transmission provides a precise shift schedule. The transmission electronics are self-calibrating; therefore, the first few shifts on a new vehicle may be somewhat abrupt. This is a normal condition, and precision shifts will develop within a few hundred miles (kilometers).

Only shift from DRIVE to PARK or REVERSE when the accelerator pedal is released and the vehicle is stopped. Be sure to keep your foot on the brake pedal when shifting between these gears.

The transmission shift lever has PARK, REVERSE, NEUTRAL, DRIVE, and AutoStick® shift positions. Manual shifts can be made using the AutoStick® shift control



(refer to “AutoStick®” in this section for further information). Moving the shift lever rearward (+) or forward (-) while in the AutoStick® position (beside the DRIVE position) will manually select the transmission gear, and will display the current gear in the instrument cluster as 1, 2, 3, etc.

### **Gear Ranges**

DO NOT race the engine when shifting from PARK or NEUTRAL into another gear range.

**NOTE:** After selecting any gear range, wait a moment to allow the selected gear to engage before accelerating. This is especially important when the engine is cold.

#### ***PARK (P)***

This range supplements the parking brake by locking the transmission. The engine can be started in this range.

Never attempt to use PARK while the vehicle is in motion. Apply the parking brake when leaving the vehicle in this range.

When parking on a level surface, you may shift the transmission into PARK first, and then apply the parking brake.

When parking on a hill, apply the parking brake before shifting the transmission to PARK, otherwise the load on the transmission locking mechanism may make it difficult to move the shift lever out of PARK. As an added precaution, turn the front wheels toward the curb on a downhill grade and away from the curb on an uphill grade.

**WARNING!**

- Never use the PARK position as a substitute for the parking brake. Always apply the parking brake fully when parked to guard against vehicle movement and possible injury or damage.
- Your vehicle could move and injure you and others if it is not completely in PARK. Check by trying to move the shift lever out of PARK with the brake pedal released. Make sure the transmission is in PARK before leaving the vehicle.

*(Continued)*

**WARNING! (Continued)**

- It is dangerous to shift out of PARK or NEUTRAL if the engine speed is higher than idle speed. If your foot is not firmly pressing the brake pedal, the vehicle could accelerate quickly forward or in reverse. You could lose control of the vehicle and hit someone or something. Only shift into gear when the engine is idling normally and your foot is firmly pressing the brake pedal.

*(Continued)*

**WARNING! (Continued)**

- Unintended movement of a vehicle could injure those in or near the vehicle. As with all vehicles, you should never exit a vehicle while the engine is running. Before exiting a vehicle, always apply the parking brake, shift the transmission into PARK, turn the engine OFF, and remove the Key Fob. When the ignition is in the OFF position, the transmission is locked in PARK, securing the vehicle against unwanted movement.
- When leaving the vehicle, always remove the Key Fob and lock your vehicle.

*(Continued)*

**WARNING! (Continued)**

- Never leave children alone in a vehicle, or with access to an unlocked vehicle. Allowing children to be in a vehicle unattended is dangerous for a number of reasons. A child or others could be seriously or fatally injured. Children should be warned not to touch the parking brake, brake pedal or the shift lever.
- Do not leave the Key Fob in or near the vehicle, (or in a location accessible to children) and do not leave the ignition (of a vehicle equipped with Keyless Enter-N-Go™) in the ACC or ON/RUN mode. A child could operate power windows, other controls, or move the vehicle.

**CAUTION!**

- Before moving the shift lever out of PARK, you must turn the ignition switch from the LOCK/OFF position to the ON/RUN position, and also press the brake pedal. Otherwise, damage to the shift lever could result.
- DO NOT race the engine when shifting from PARK or NEUTRAL into another gear range, as this can damage the drivetrain.

The following indicators should be used to ensure that you have engaged the transmission into the PARK position:

- When shifting into PARK, firmly move the shift lever all the way forward until it stops and is fully seated.

- Look at the transmission gear position display and verify that it indicates the PARK position.
- With brake pedal released, verify that the shift lever will not move out of PARK.

**REVERSE (R)**

This range is for moving the vehicle backward. Shift into REVERSE only after the vehicle has come to a complete stop.

**NEUTRAL (N)**

Use this range when the vehicle is standing for prolonged periods with the engine running. The engine may be started in this range. Apply the parking brake and shift the transmission into PARK if you must leave the vehicle.

**WARNING!**

Do not coast in NEUTRAL and never turn off the ignition to coast down a hill. These are unsafe practices that limit your response to changing traffic or road conditions. You might lose control of the vehicle and have a collision.

**CAUTION!**

Towing the vehicle, coasting, or driving for any other reason with the transmission in NEUTRAL can cause severe transmission damage. Refer to "Recreational Towing" in "Starting And Operating" and "Towing A Disabled Vehicle" in "What To Do In Emergencies" for further information.

**DRIVE (D)**

This range should be used for most city and highway driving. It provides the smoothest upshifts and downshifts, and the best fuel economy. The transmission automatically upshifts through underdrive first, second, third, and fourth gears, direct fifth gear and overdrive sixth gear. The DRIVE position provides optimum driving characteristics under all normal operating conditions.

When frequent transmission shifting occurs (such as when operating the vehicle under heavy loading conditions, in hilly terrain, traveling into strong head winds, or while towing heavy trailers), use the AutoStick® shift control (refer to "AutoStick®" in this section for further information) to select a lower gear. Under these conditions, using a lower gear will improve performance and extend transmission life by reducing excessive shifting and heat buildup.

If the transmission temperature exceeds normal operating limits, the transmission controller will modify the transmission shift schedule and expand the range of torque converter clutch engagement. This is done to prevent transmission damage due to overheating. If the transmission becomes extremely hot, the "Transmission Temperature Warning Light" may illuminate and the transmission may operate differently until the transmission cools down.

During very cold temperatures (-4°F [-20°C] or below), transmission operation may be modified depending on engine and transmission temperature as well as vehicle speed. Normal operation will resume once the transmission temperature has risen to a suitable level.

### *Transmission Limp Home Mode*

Transmission function is monitored electronically for abnormal conditions. If a condition is detected that could result in transmission damage, Transmission Limp Home

Mode is activated. In this mode, the transmission remains in fourth gear regardless of which forward gear is selected. PARK, REVERSE, and NEUTRAL will continue to operate. The Malfunction Indicator Light (MIL) may be illuminated. Limp Home Mode allows the vehicle to be driven to an authorized dealer for service without damaging the transmission.

In the event of a momentary problem, the transmission can be reset to regain all forward gears by performing the following steps:

1. Stop the vehicle.
2. Shift the transmission into PARK.
3. Turn the ignition switch to the OFF position.
4. Wait approximately 10 seconds.
5. Restart the engine.

6. Shift into the desired gear range. If the problem is no longer detected, the transmission will return to normal operation.

**NOTE:** Even if the transmission can be reset, we recommend that you visit your authorized dealer at your earliest possible convenience. Your authorized dealer has diagnostic equipment to determine if the problem could recur.

If the transmission cannot be reset, authorized dealer service is required.

### *Overdrive Operation*

The automatic transmission includes an electronically controlled Overdrive (sixth gear). The transmission will automatically shift into Overdrive if the following conditions are present:

- The shift lever is in the DRIVE position.

- The transmission fluid has reached an adequate temperature.
- The engine coolant has reached an adequate temperature.
- Vehicle speed is sufficiently high.
- The driver is not heavily pressing the accelerator.

### *Torque Converter Clutch*

A feature designed to improve fuel economy has been included in the automatic transmission on your vehicle. A clutch within the torque converter engages automatically at calibrated speeds. This may result in a slightly different feeling or response during normal operation in the upper gears. When the vehicle speed drops or during some accelerations, the clutch automatically disengages.

**NOTE:** Engagement of the torque converter clutch is inhibited at very cold temperatures. Because the engine speed is higher when the torque converter clutch is not engaged, it may seem as if the transmission is not shifting into Overdrive when cold. This is normal. The torque converter clutch will function normally once the transmission is sufficiently warm.

## **AUTOSTICK®**

AutoStick® is a driver-interactive transmission feature providing manual shift control, giving you more control of the vehicle. AutoStick® allows you to maximize engine braking, eliminate undesirable upshifts and downshifts, and improve overall vehicle performance. This system can also provide you with more control during passing, city driving, cold slippery conditions, mountain driving, and many other situations.

## **Operation**

When the shift lever is in the AutoStick® position (beside the DRIVE position), it can be moved forward and rearward. This allows the driver to manually select the transmission gear being used. Moving the shift lever forward (-) triggers a downshift and rearward (+) an upshift. The current gear is displayed in the instrument cluster. In AutoStick® mode, the transmission will shift up or down when the driver moves the shift lever rearward (+) or forward (-), unless an engine lugging or overspeed condition would result. It will remain in the selected gear until another upshift or downshift is chosen, except as described below.

- For all models except GT, the transmission will automatically upshift when necessary to prevent engine over-speed.
- For GT models, the transmission will remain in the selected gear even when maximum engine speed is



reached. The transmission will upshift only when commanded by the driver. Engine overspeed protection is provided by the engine controls.

- The transmission will automatically downshift to first gear when coming to a stop. After a stop, the driver should manually upshift (+) the transmission as the vehicle is accelerated.
- With 2.0L or 2.4L engine, you can start out, from a stop, in first or second gear. Tapping (+) (at a stop) will allow starting in second gear. Starting out in second gear is helpful in snowy or icy conditions.
- If a requested downshift would cause the engine to over-speed, that shift will not occur.
- Avoid using speed control when AutoStick® is engaged.
- Transmission shifting will be more noticeable when AutoStick® is engaged.

- If the system detects powertrain overheating, the transmission will revert to automatic shift mode and remain in that mode until the powertrain cools off.
- If the system detects a problem, it will disable AutoStick® mode and the transmission will return to the automatic mode until the problem is corrected.

To disengage AutoStick® mode, return the shift lever to the DRIVE position. You can shift in or out of the AutoStick® position at any time without taking your foot off the accelerator pedal.

### WARNING!

**Do not downshift for additional engine braking on a slippery surface. The drive wheels could lose their grip and the vehicle could skid, causing a collision or personal injury.**

## DRIVING ON SLIPPERY SURFACES

### Acceleration

Rapid acceleration on snow covered, wet, or other slippery surfaces may cause the driving wheels to pull erratically to the right or left. This phenomenon occurs when there is a difference in the surface traction under the front (driving) wheels.

### WARNING!

**Rapid acceleration on slippery surfaces is dangerous. Unequal traction can cause sudden pulling of the front wheels. You could lose control of the vehicle and possibly have a collision. Accelerate slowly and carefully whenever there is likely to be poor traction (ice, snow, wet, mud, loose sand, etc.).**

### Traction

When driving on wet or slushy roads, it is possible for a wedge of water to build up between the tire and road surface. This is hydroplaning and may cause partial or complete loss of vehicle control and stopping ability. To reduce this possibility, the following precautions should be observed:

1. Slow down during rainstorms or when the roads are slushy.
2. Slow down if the road has standing water or puddles.
3. Replace the tires when tread wear indicators first become visible.
4. Keep tires properly inflated.
5. Maintain sufficient distance between your vehicle and the vehicle in front of you to avoid a collision in a sudden stop.

## DRIVING THROUGH WATER

Driving through water more than a few inches/centimeters deep will require extra caution to ensure safety and prevent damage to your vehicle.

### Flowing/Rising Water

#### WARNING!

Do not drive on or across a road or path where water is flowing and/or rising (as in storm run-off). Flowing water can wear away the road or path's surface and cause your vehicle to sink into deeper water. Furthermore, flowing and/or rising water can carry your vehicle away swiftly. Failure to follow this warning may result in injuries that are serious or fatal to you, your passengers, and others around you.

### Shallow Standing Water

Although your vehicle is capable of driving through shallow standing water, consider the following Cautions and Warnings before doing so.

#### CAUTION!

- Always check the depth of the standing water before driving through it. Never drive through standing water that is deeper than the bottom of the tire rims mounted on the vehicle.
- Determine the condition of the road or the path that is under water and if there are any obstacles in the way before driving through the standing water.
- Do not exceed 5 mph (8 km/h) when driving through standing water. This will minimize wave effects.

*(Continued)*

**CAUTION!** *(Continued)*

- Driving through standing water may cause damage to your vehicle's drivetrain components. Always inspect your vehicle's fluids (i.e., engine oil, transmission, axle, etc.) for signs of contamination (i.e., fluid that is milky or foamy in appearance) after driving through standing water. Do not continue to operate the vehicle if any fluid appears contaminated, as this may result in further damage. Such damage is not covered by the New Vehicle Limited Warranty.
- Getting water inside your vehicle's engine can cause it to lock up and stall out, and cause serious internal damage to the engine. Such damage is not covered by the New Vehicle Limited Warranty.

**WARNING!**

- Driving through standing water limits your vehicle's traction capabilities. Do not exceed 5 mph (8 km/h) when driving through standing water.
- Driving through standing water limits your vehicle's braking capabilities, which increases stopping distances. Therefore, after driving through standing water, drive slowly and lightly press on the brake pedal several times to dry the brakes.
- Failure to follow these warnings may result in injuries that are serious or fatal to you, your passengers, and others around you.

**PARKING BRAKE**

Before leaving the vehicle, make sure that the parking brake is fully applied. Also, be certain to leave an automatic transmission in PARK, or manual transmission in REVERSE or first gear.

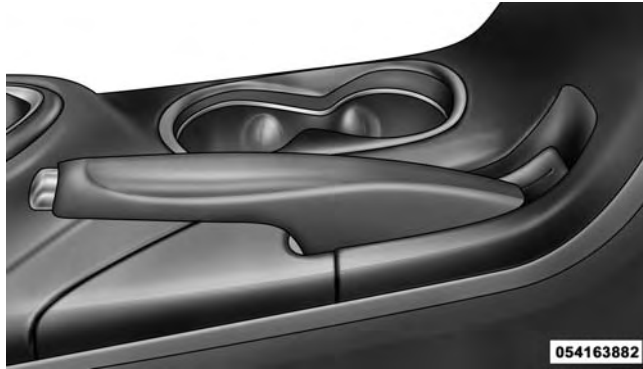

### Parking Brake

The parking brake lever is located in the center console. To apply the parking brake, pull the lever up as firmly as possible. To release the parking brake, pull the lever up slightly, press the center button, then lower the lever completely.

When the parking brake is applied with the ignition switch in the ON position, the “Brake Warning Light” in the instrument cluster will illuminate.

#### NOTE:

- When the parking brake is applied and the automatic transmission is placed in gear, the “Brake Warning Light” will flash. If vehicle speed is detected, a chime will sound to alert the driver. Fully release the parking brake before attempting to move the vehicle.
- This light only shows that the parking brake is applied. It does not show the degree of brake application. When parking on a hill, it is important to turn the front wheels toward the curb on a downhill grade and away from the curb on an uphill grade. For vehicles equipped with an automatic transmission, apply the parking brake before placing the shift lever in PARK, otherwise the load on the transmission locking mechanism may make it difficult to move the shift lever out

of PARK. The parking brake should always be applied whenever the driver is not in the vehicle.

**WARNING!**

- Never use the PARK position as a substitute for the parking brake. Always apply the parking brake fully when parked to guard against vehicle movement and possible injury or damage.
- When leaving the vehicle, always remove the Key Fob from the ignition and lock your vehicle.
- Never leave children alone in a vehicle, or with access to an unlocked vehicle. Allowing children to be in a vehicle unattended is dangerous for a number of reasons. A child or others could be seriously or fatally injured. Children should be warned not to touch the parking brake, brake pedal or the shift lever.

*(Continued)*

**WARNING! (Continued)**

- Do not leave the Key Fob in or near the vehicle (or in a location accessible to children), and do not leave the ignition of a vehicle equipped with Keyless Enter-N-Go™ in the ACC or ON/RUN mode. A child could operate power windows, other controls, or move the vehicle.
- Be sure the parking brake is fully disengaged before driving; failure to do so can lead to brake failure and a collision.
- Always fully apply the parking brake when leaving your vehicle, or it may roll and cause damage or injury. Also be certain to leave the transmission in PARK. Failure to do so may allow the vehicle to roll and cause damage or injury.

**CAUTION!**

If the “Brake Warning Light” remains on with the parking brake released, a brake system malfunction is indicated. Have the brake system serviced by an authorized dealer immediately.

**WARNING!**

Continued operation with reduced assist could pose a safety risk to yourself and others. Service should be obtained as soon as possible.

**POWER STEERING**

The electric power steering system will give you good vehicle response and increased ease of maneuverability in tight spaces. The system will vary its assist to provide light efforts while parking and good feel while driving. If the electric steering system experiences a fault that reduces assist or prevents the vehicle from providing assist, you will still have the ability to steer the vehicle manually.



If the “SERVICE POWER STEERING” message and a steering wheel icon are displayed on the EVIC screen, it indicates that the vehicle needs to be taken to the dealer for service. It is likely the vehicle has lost power steering assistance. Refer to “Electronic Vehicle Information (EVIC)” in “Understanding Your Instrument Panel” for further information.

**NOTE:**

- Even if the power steering assistance is no longer operational, it is still possible to steer the vehicle. Under these conditions there will be a substantial increase in steering effort, especially at low speeds and during parking maneuvers.
- If the condition persists, see your authorized dealer for service.

**ELECTRONIC BRAKE CONTROL SYSTEM**

Your vehicle is equipped with an advanced electronic brake control system. This system includes Anti-Lock Brake System (ABS), Brake Assist System (BAS), Traction Control System (TCS), Electronic Roll Mitigation (ERM), Trailer Sway Control (TCS), Hill Start Assist (HSA), Brake Lock Differential (BLD), and Electronic Stability Control (ESC). These systems work together to enhance both

vehicle stability and control in various driving conditions.

**WARNING!**

**Electronic Stability Control (ESC) cannot prevent the natural laws of physics from acting on the vehicle, nor can it increase the traction afforded by prevailing road conditions. ESC cannot prevent accidents, including those resulting from excessive speed in turns, driving on very slippery surfaces, or hydroplaning. ESC also cannot prevent accidents resulting from loss of vehicle control due to inappropriate driver input for the conditions. Only a safe, attentive, and skillful driver can prevent accidents. The capabilities of an ESC equipped vehicle must never be exploited in a reckless or dangerous manner which could jeopardize the user's safety or the safety of others.**



## Anti-Lock Brake System (ABS)

The Anti-Lock Brake System (ABS) provides increased vehicle stability and brake performance under most braking conditions. The system automatically prevents wheel lock, reduces stop distance, and enhances vehicle control during stop.

When the vehicle is driven over 6 mph (10 km/h), you may also hear a slight clicking sound as well as some related motor noises. These noises are the system performing its self-check cycle to ensure that the ABS is working properly. This self-check occurs each time the vehicle is started and accelerated past 6 mph (10 km/h).

ABS is activated during braking under certain road or stopping conditions. ABS-inducing conditions can include ice, snow, gravel, bumps, railroad tracks, loose debris, or panic stops.

You also may experience the following when the brake system goes into anti-lock:

- The ABS motor running (it may continue to run for a short time after the stop).
- The clicking sound of solenoid valves.
- Brake pedal pulsations.
- A slight drop or fall away of the brake pedal at the end of the stop.

These are all normal characteristics of ABS.

**WARNING!**

- The ABS contains sophisticated electronic equipment that may be susceptible to interference caused by improperly installed or high output radio transmitting equipment. This interference can cause possible loss of anti-lock braking capability. Installation of such equipment should be performed by qualified professionals.
- Pumping of the Anti-Lock Brakes will diminish their effectiveness and may lead to a collision. Pumping makes the stopping distance longer. Just press firmly on your brake pedal when you need to slow down or stop.

*(Continued)*

**WARNING! (Continued)**

- The ABS cannot prevent the natural laws of physics from acting on the vehicle, nor can it increase braking or steering efficiency beyond that afforded by the condition of the vehicle brakes and tires or the traction afforded.
- The ABS cannot prevent collisions, including those resulting from excessive speed in turns, following another vehicle too closely, or hydroplaning.
- The capabilities of an ABS equipped vehicle must never be exploited in a reckless or dangerous manner that could jeopardize the user's safety or the safety of others.

All vehicle wheels and tires must be the same size and type and tires must be properly inflated to produce accurate signals for the computer.

## Anti-Lock Brake Warning Light



The “Anti-Lock Brake Warning Light” monitors the ABS. The light will turn on when the ignition switch is turned to the ON position and may stay on for as long as four seconds.

If the “ABS Warning Light” remains on or comes on while driving, it indicates that the anti-lock portion of the brake system is not functioning and that service is required. However, the conventional brake system will continue to operate normally if the “Brake System Warning Light” is not on.

If the “ABS Warning Light” is on, the brake system should be serviced as soon as possible to restore the benefits of anti-lock brakes. If the “ABS Warning Light” does not come on when the ignition switch is turned to the ON position, have the light repaired as soon as possible.

If both the “Brake System Warning Light” and the “ABS Warning Light” remain on, the ABS and Electronic Brake Force Distribution (EBD) systems are not functioning. Immediate repair to the ABS system is required.

## Brake Assist System (BAS)

The BAS is designed to optimize the vehicle’s braking capability during emergency braking maneuvers. The system detects an emergency braking situation by sensing the rate and amount of brake application and then applies optimum pressure to the brakes. This can help reduce braking distances. The BAS complements the ABS. Applying the brakes very quickly results in the best BAS assistance. To receive the benefit of the system, you must apply continuous braking pressure during the stopping sequence, (do not “pump” the brakes). Do not reduce brake pedal pressure unless braking is no longer desired. Once the brake pedal is released, the BAS is deactivated.

**WARNING!**

**BAS cannot prevent the natural laws of physics from acting on the vehicle, nor can it increase the traction afforded by prevailing road conditions. BAS cannot prevent accidents, including those resulting from excessive speed in turns, driving on very slippery surfaces, or hydroplaning. The capabilities of a BAS-equipped vehicle must never be exploited in a reckless or dangerous manner, which could jeopardize the user's safety or the safety of others.**

**Traction Control System (TCS)**

This system monitors the amount of wheel spin of each of the driven wheels. If wheel spin is detected, brake pressure is applied to the slipping wheel(s) and engine power is reduced to provide enhanced acceleration and stability. A feature of the TCS functions similar to a limited slip differential (BLD) and controls the wheel spin

across a driven axle. If one wheel on a driven axle is spinning faster than the other, the system will apply the brake of the spinning wheel. This will allow more engine torque to be applied to the wheel that is not spinning. This feature remains active even if TCS and ESC are in the "Partial Off" mode. Refer to "Electronic Stability Control (ESC)" in this section for more information.

**Electronic Roll Mitigation (ERM)**

This system anticipates the potential for wheel lift by monitoring the driver's steering wheel input and the speed of the vehicle. When ERM determines that the rate of change of the steering wheel angle and vehicle's speed are sufficient to potentially cause wheel lift, it then applies the appropriate brake and may also reduce engine power to lessen the chance that wheel lift will occur. ERM will only intervene during very severe or evasive driving maneuvers.

ERM can only reduce the chance of wheel lift occurring during severe or evasive driving maneuvers. It cannot prevent wheel lift due to other factors, such as road conditions, leaving the roadway, or striking objects or other vehicles.

### **WARNING!**

**Many factors, such as vehicle loading, road conditions, and driving conditions, influence the chance that wheel lift or rollover may occur. ERM cannot prevent all wheel lift or rollovers, especially those that involve leaving the roadway or striking objects or other vehicles. The capabilities of an ERM-equipped vehicle must never be exploited in a reckless or dangerous manner, which could jeopardize the user's safety or the safety of others.**

### **Trailer Sway Control (TSC)**

TSC uses sensors in the vehicle to recognize an excessively swaying trailer. TSC activates automatically once the excessively swaying trailer is recognized. When TSC is functioning, the "ESC Light" will flash, the engine power will be reduced, and you will feel the brake being applied to individual wheels in an attempt to stop the trailer from swaying.

**NOTE:** The TSC is disabled when the ESC system is in the "Partial Off" mode.

**WARNING!**

- TSC cannot stop all trailers from swaying. Always use caution when towing a trailer and follow the tongue weight recommendations. Refer to "Vehicle Loading" and "Trailer Towing" in "Starting and Operating" for further information.
- If TSC activates while towing a trailer, stop the vehicle at the nearest safe location and adjust the trailer load to eliminate the trailer sway.
- Failure to follow these warnings can result in an accident or serious personal injury.

**Hill Start Assist (HSA)**

The HSA system is designed to assist the driver when starting a vehicle from a stop on a hill. HSA will maintain the level of brake pressure the driver applied for a short period of time after the driver takes their foot off of the brake pedal. If the driver does not apply the throttle

during this short period of time, the system will release brake pressure and the vehicle will roll down the hill. The system will release brake pressure in proportion to the amount of throttle applied as the vehicle starts to move in the intended direction of travel.

**Hill Start Assist Disable Procedure**

**NOTE:** Vehicle roll back mitigation will not be present with this feature disabled.

Hill Start assist can be disabled if desired. This procedure applies to vehicles equipped with a manual or Powertech transmission.

1. Wheels must be pointed straight ahead, on a level surface.
2. Automatic transmission should be in PARK.
3. Place manual transmission in NEUTRAL if equipped.
4. Begin with the ignition OFF.

5. Engage park brake.
6. Start engine and wait for ESC OFF lamp to turn off.
7. Apply brake pedal.
8. Turn steering wheel 200 degrees counter clockwise, just over half a turn from center position. Press the "ESC off" button four times.
9. Rotate the steering wheel back to center and continue in a clockwise direction until 200 degrees past center.
10. Turn the ignition to OFF position.
11. If procedure was done correctly, ESC malfunction lamp will flash four times after engine starts.
12. Procedure must be completed within 90 seconds.
13. Repeat the condition to re-enable Hill Start Assist (HSA).

### HSA Activation Criteria

The following criteria must be met in order for HSA to activate:

- Vehicle must be stopped.
- Vehicle must be on a 3% (manual transmission), 3.5% (automated manual transmission), or 8% grade or greater (automatic transmission) hill.
- Gear selection matches vehicle uphill direction (i.e., vehicle facing uphill is in forward gear; vehicle backing uphill is in REVERSE gear).

HSA will work in REVERSE and all forward gears when the activation criteria have been met. The system will not activate if the vehicle is placed in NEUTRAL or PARK.

**WARNING!**

There may be situations on minor hills with a loaded vehicle, or while pulling a trailer, when the system will not activate and slight rolling may occur. This could cause a collision with another vehicle or object. Always remember the driver is responsible for braking the vehicle.

**Towing With HSA**

HSA will provide assistance when starting on a grade when pulling a trailer.

**WARNING!**

- If you use a trailer brake controller with your trailer, your trailer brakes may be activated and deactivated with the brake switch. If so, when the brake pedal is released there may not be enough brake pressure to hold the vehicle and trailer on a hill and this could cause a collision with another vehicle or object behind you. In order to avoid rolling down the hill while resuming acceleration, manually activate the trailer brake prior to releasing the brake pedal. Always remember the driver is responsible for braking the vehicle.
- HSA is not a parking brake. Always apply the parking brake fully when leaving your vehicle. Also, be certain to leave the transmission in PARK.

*(Continued)*



**WARNING! (Continued)**

- Failure to follow these warnings may cause the vehicle to roll down the incline and could collide with another vehicle, object or person, and cause serious or fatal injury. Always remember to use the parking brake while parking on a hill and that the driver is responsible for braking the vehicle.

**NOTE:** The HSA system may also be turned on and off if the vehicle is equipped with the Electronic Vehicle Information Center (EVIC). Refer to “Electronic Vehicle Information Center (EVIC)” in “Understanding Your Instrument Panel” for further information.

**Electronic Stability Control (ESC)**

This system enhances directional control and stability of the vehicle under various driving conditions. ESC corrects for over-steering and under-steering the vehicle by

applying the brake of the appropriate wheel. Engine power may also be reduced to help the vehicle maintain the desired path.

ESC reduces engine torque and applies brake pressure to select individual wheels to mitigate vehicle under-steer and vehicle over-steer. The system uses engine torque reduction along with individual wheel brake pressure to correct under-steer and over-steer conditions.

- Over-steer - when the vehicle is turning more than appropriate for the steering wheel position.
- Under-steer - when the vehicle is turning less than appropriate for the steering wheel position.

**ESC Operating Modes**

The ESC system has two available operating modes.

## Full On

This is the normal operating mode for ESC. Whenever the vehicle is started the system will be in this mode. This mode should be used for most driving situations. ESC should only be turned to "Partial Off" for specific reasons as noted. Refer to "Partial Off" for additional information.

## Partial Off

The "ESC Off" button is located in the switch bank above the climate control. To enter the "Partial Off" mode, momentarily press the "ESC Off" button and the "ESC Off Indicator Light" will illuminate. To turn the ESC on again, momentarily press the "ESC Off" button and the "ESC Off Indicator Light" will turn off. This will restore the normal "ESC On" mode of operation.

### WARNING!

- When in "Partial Off" mode, the TCS functionality of ESC, (except for the limited slip feature described in the TCS section), has been disabled and the "ESC Off Indicator Light" will be illuminated. When in "Partial Off" mode, the engine power reduction feature of TCS is disabled, and the enhanced vehicle stability offered by the ESC system is reduced.
- Trailer Sway Control (TSC) is disabled when the ESC system is in the "Partial Off" mode.

**NOTE:** When driving with snow chains, or when starting off in deep snow, sand, or gravel, it may be desirable to allow more wheel spin when starting off in snow, mud, sand, gravel, or when using tire chains. This can be accomplished by momentarily pressing the "ESC off" button to enter partial mode "Partial Off" mode. Once the

situation requiring “Partial Off” mode is overcome, turn ESC back on by momentarily pressing the “ESC Off” button. This may be done while the vehicle is in motion

### ESC Activation/Malfunction Indicator Light



The “ESC Activation/Malfunction Indicator Light” in the instrument cluster will come on when the ignition switch is turned to the ON position. It should go out with the engine running. The “ESC Activation/Malfunction Indicator Light” will flash to indicate the system is actively correcting an undesirable vehicle condition. This includes Yaw control, traction control, and trailer sway control. If the lamp remains solid under normal driving conditions, your vehicle should be serviced at an authorized dealer.

The “ESC Activation/Malfunction Indicator Light” starts to flash as soon as the tires lose traction and the ESC system becomes active.

The “ESC Activation/Malfunction Indicator Light” also flashes when the Traction Control System (TCS) or trailer sway is active. If the “ESC Activation/Malfunction Indicator Light” begins to flash during acceleration, ease up on the accelerator and apply as little throttle as possible. Be sure to adapt your speed and driving to the prevailing road conditions.

#### NOTE:

- The “ESC Off Indicator Light” and the “ESC Activation/Malfunction Indicator Light” come on momentarily each time the ignition switch is turned ON.
- Each time the ignition is turned ON, the ESC system will be ON even if it was turned off previously.
- The ESC system may make buzzing or clicking sounds when it is active. This is normal; the sounds will stop when ESC becomes inactive following the maneuver that caused the ESC activation.

## ESC Off Indicator Light



The “ESC OFF Indicator Light” indicates the Electronic Stability Control (ESC) is partially off.

In some cases, when accelerating from stop on steep grades, it may be beneficial to turn off ESC. Once the grade ascent is complete, ESC can be turned on again.

## TIRE SAFETY INFORMATION

### Tire Markings

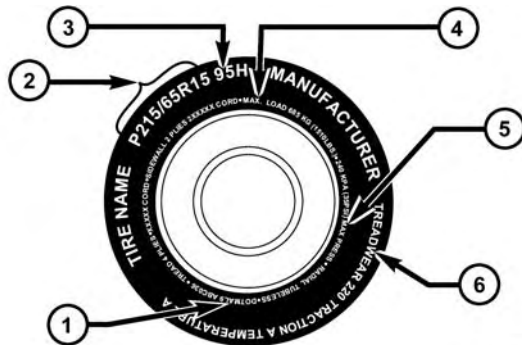

054903773

- |  |  |
|--|--|
| 1 — U.S. DOT Safety Standards Code (TIN) | 4 — Maximum Load                               |
| 2 — Size Designation                     | 5 — Maximum Pressure                           |
| 3 — Service Description                  | 6 — Treadwear, Traction and Temperature Grades |

**NOTE:**

- P (Passenger) - Metric tire sizing is based on U.S. design standards. P-Metric tires have the letter "P" molded into the sidewall preceding the size designation. Example: P215/65R15 95H.
- European-Metric tire sizing is based on European design standards. Tires designed to this standard have the tire size molded into the sidewall beginning with the section width. The letter "P" is absent from this tire size designation. Example: 215/65R15 96H.
- LT (Light Truck) - Metric tire sizing is based on U.S. design standards. The size designation for LT-Metric tires is the same as for P-Metric tires except for the letters "LT" that are molded into the sidewall preceding the size designation. Example: LT235/85R16.
- Temporary spare tires are designed for temporary emergency use only. Temporary high pressure compact spare tires have the letter "T" or "S" molded into the sidewall preceding the size designation. Example: T145/80D18 103M.
- High flotation tire sizing is based on U.S. design standards and it begins with the tire diameter molded into the sidewall. Example: 31x10.5 R15 LT.

## Tire Sizing Chart

<b>EXAMPLE:</b>	
<b>Size Designation:</b>	
<b>P</b>	= Passenger car tire size based on U.S. design standards
<b>"...blank..."</b>	= Passenger car tire based on European design standards
<b>LT</b>	= Light truck tire based on U.S. design standards
<b>T or S</b>	= Temporary spare tire
<b>31</b>	= Overall diameter in inches (in)
<b>215</b>	= Section width in millimeters (mm)
<b>65</b>	= Aspect ratio in percent (%) — Ratio of section height to section width of tire
<b>10.5</b>	= Section width in inches (in)
<b>R</b>	= Construction code — "R" means radial construction — "D" means diagonal or bias construction
<b>15</b>	= Rim diameter in inches (in)

**EXAMPLE:****Service Description:**

95 = Load Index

— A numerical code associated with the maximum load a tire can carry

H = Speed Symbol

— A symbol indicating the range of speeds at which a tire can carry a load corresponding to its load index under certain operating conditions

— The maximum speed corresponding to the speed symbol should only be achieved under specified operating conditions (i.e., tire pressure, vehicle loading, road conditions, and posted speed limits)

**Load Identification:**

"...blank..." = Absence of any text on the sidewall of the tire indicates a Standard Load (SL) tire

**Extra Load (XL)** = Extra load (or reinforced) tire

**Light Load (LL)** = Light load tire

**C, D, E, F, G** = Load range associated with the maximum load a tire can carry at a specified pressure

**Maximum Load**— Maximum load indicates the maximum load this tire is designed to carry

**Maximum Pressure**— Maximum pressure indicates the maximum permissible cold tire inflation pressure for this tire

### Tire Identification Number (TIN)

The TIN may be found on one or both sides of the tire, however, the date code may only be on one side. Tires with white sidewalls will have the full TIN, including the date code, located on the white sidewall side of the tire.

Look for the TIN on the outboard side of black sidewall tires as mounted on the vehicle. If the TIN is not found on the outboard side, then you will find it on the inboard side of the tire.

#### EXAMPLE:

**DOT MA L9 ABCD 0301**

**DOT** = Department of Transportation

— This symbol certifies that the tire is in compliance with the U.S. Department of Transportation tire safety standards and is approved for highway use

**MA** = Code representing the tire manufacturing location (two digits)

**L9** = Code representing the tire size (two digits)

**ABCD** = Code used by the tire manufacturer (one to four digits)

**03** = Number representing the week in which the tire was manufactured (two digits)

— 03 means the 3rd week

**01** = Number representing the year in which the tire was manufactured (two digits)

— 01 means the year 2001

— Prior to July 2000, tire manufacturers were only required to have one number to represent the year in which the tire was manufactured. Example: 031 could represent the 3rd week of 1981 or 1991



## Tire Terminology And Definitions

Term	Definition
<b>B-Pillar</b>	The vehicle B-Pillar is the structural member of the body located behind the front door.
<b>Cold Tire Inflation Pressure</b>	Cold tire inflation pressure is defined as the tire pressure after the vehicle has not been driven for at least 3 hours, or driven less than 1 mile (1.6 km) after sitting for a three hour period. Inflation pressure is measured in units of PSI (pounds per square inch) or kPa (kilopascals).
<b>Maximum Inflation Pressure</b>	The maximum inflation pressure is the maximum permissible cold tire inflation pressure for this tire. The maximum inflation pressure is molded into the sidewall.
<b>Recommended Cold Tire Inflation Pressure</b>	Vehicle manufacturer's recommended cold tire inflation pressure as shown on the tire placard.
<b>Tire Placard</b>	A paper label permanently attached to the vehicle describing the vehicle's loading capacity, the original equipment tire sizes and the recommended cold tire inflation pressures.

## Tire Loading And Tire Pressure

### Tire And Loading Information Placard Location

**NOTE:** The proper cold tire inflation pressure is listed on the driver's side B-Pillar or the rear edge of the driver's side door.

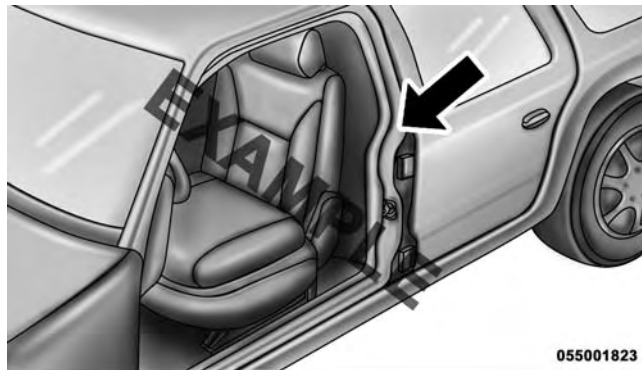

**B-Pillar Location For Tire And Loading  
Information Placard**

## Tire And Loading Information Placard

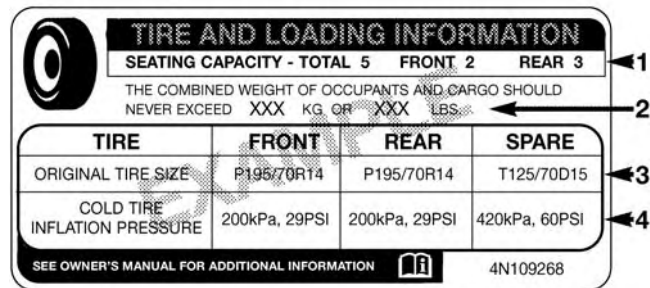

The placard features a tire icon on the left. The title 'TIRE AND LOADING INFORMATION' is at the top. Below it, 'SEATING CAPACITY - TOTAL 5 FRONT 2 REAR 3' is indicated with arrow 1. A warning line states 'THE COMBINED WEIGHT OF OCCUPANTS AND CARGO SHOULD NEVER EXCEED XXX KG OR XXX LBS.' with arrow 2. A table with four columns (TIRE, FRONT, REAR, SPARE) and two rows (ORIGINAL TIRE SIZE, COLD TIRE INFLATION PRESSURE) is shown with arrows 3 and 4 pointing to the original size and cold tire pressure rows respectively. At the bottom, it says 'SEE OWNER'S MANUAL FOR ADDITIONAL INFORMATION' with an information icon and the number '4N109268'.

TIRE	FRONT	REAR	SPARE
ORIGINAL TIRE SIZE	P195/70R14	P195/70R14	T125/70D15
COLD TIRE INFLATION PRESSURE	200kPa, 29PSI	200kPa, 29PSI	420kPa, 60PSI

811b5a9a

Tire And Loading Information Placard

This placard tells you important information about the:

1. Number of people that can be carried in the vehicle.
2. Total weight your vehicle can carry.
3. Tire size designed for your vehicle.
4. Cold tire inflation pressures for the front, rear, and spare tires.

## Loading

The vehicle maximum load on the tire must not exceed the load carrying capacity of the tire on your vehicle. You will not exceed the tire's load carrying capacity if you adhere to the loading conditions, tire size, and cold tire inflation pressures specified on the Tire and Loading Information placard and in the "Vehicle Loading" section of this manual.

**NOTE:** Under a maximum loaded vehicle condition, gross axle weight ratings (GAWRs) for the front and rear axles must not be exceeded. For further information on GAWRs, vehicle loading, and trailer towing, refer to "Vehicle Loading" in this section.

To determine the maximum loading conditions of your vehicle, locate the statement "The combined weight of occupants and cargo should never exceed XXX lbs or XXX kg" on the Tire and Loading Information placard. The combined weight of occupants, cargo/luggage and trailer tongue weight (if applicable) should never exceed the weight referenced here.

### Steps For Determining Correct Load Limit

1. Locate the statement "The combined weight of occupants and cargo should never exceed XXX lbs or XXX kg" on your vehicle's placard.
2. Determine the combined weight of the driver and passengers that will be riding in your vehicle.

3. Subtract the combined weight of the driver and passengers from XXX lbs or XXX kg.
4. The resulting figure equals the available amount of cargo and luggage load capacity. For example, if “XXX” amount equals 1,400 lbs (635 kg) and there will be five 150 lb (68 kg) passengers in your vehicle, the amount of available cargo and luggage load capacity is 650 lbs (295 kg) (since  $5 \times 150 \text{ lbs (68 kg)} = 750 \text{ lbs (340 kg)}$ ), and  $1400 \text{ lbs (635 kg)} - 750 \text{ lbs (340 kg)} = 650 \text{ lbs [295 kg]}$ ).
5. Determine the combined weight of luggage and cargo being loaded on the vehicle. That weight may not safely exceed the available cargo and luggage load capacity calculated in step 4.

**NOTE:**

- If your vehicle will be towing a trailer, load from your trailer will be transferred to your vehicle. The following table shows examples on how to calculate total load, cargo/luggage, and towing capacities of your vehicle with varying seating configurations and number and size of occupants. This table is for illustration purposes only and may not be accurate for the seating and load carry capacity of your vehicle.
- For the following example, the combined weight of occupants and cargo should never exceed 865 lbs (392 kg).

Occupants			Combined weight of occupants and cargo from Tire Placard	MINUS	Combined Occupant's weight	=	AVAILABLE Cargo/Luggage and Trailer Tongue Weight
TOTAL	FRONT	REAR					
<u>EXAMPLE 1</u>			↓ 865 lbs	minus	Occupant 1: 200 lbs Occupant 2: 130 lbs Occupant 3: 160 lbs Occupant 4: 100 lbs Occupant 5: 80 lbs TOTAL WEIGHT: 670 lbs	=	↓ 195 lbs
5	2	3					
<u>EXAMPLE 2</u>			865 lbs	minus	Occupant 1: 210 lbs Occupant 2: 180 lbs Occupant 3: 150 lbs TOTAL WEIGHT: 540 lbs	=	325 lbs
3	2	1					
<u>EXAMPLE 3</u>			865 lbs	minus	Occupant 1: 200 lbs Occupant 2: 200 lbs TOTAL WEIGHT: 400 lbs	=	465 lbs
2	2	0					

**WARNING!**

Overloading of your tires is dangerous. Overloading can cause tire failure, affect vehicle handling, and increase your stopping distance. Use tires of the recommended load capacity for your vehicle. Never overload them.

**TIRES — GENERAL INFORMATION****Tire Pressure**

Proper tire inflation pressure is essential to the safe and satisfactory operation of your vehicle. Three primary areas are affected by improper tire pressure:

**Safety****WARNING!**

- Improperly inflated tires are dangerous and can cause collisions.
- Under-inflation increases tire flexing and can result in over-heating and tire failure.
- Over-inflation reduces a tire's ability to cushion shock. Objects on the road and chuckholes can cause damage that result in tire failure.
- Over-inflated or under-inflated tires can affect vehicle handling and can fail suddenly, resulting in loss of vehicle control.
- Unequal tire pressures can cause steering problems. You could lose control of your vehicle.

*(Continued)*

**WARNING! (Continued)**

- Unequal tire pressures from one side of the vehicle to the other can cause the vehicle to drift to the right or left.
- Always drive with each tire inflated to the recommended cold tire inflation pressure.

**Economy**

Improper inflation pressures can cause uneven wear patterns to develop across the tire tread. These abnormal wear patterns will reduce tread life resulting in a need for earlier tire replacement. Under-inflation also increases tire rolling resistance resulting in higher fuel consumption.

**Ride Comfort And Vehicle Stability**

Proper tire inflation contributes to a comfortable ride. Over-inflation produces a jarring and uncomfortable ride. Both under-inflation and over-inflation affect the

stability of the vehicle and can produce a feeling of sluggish response or over responsiveness in the steering.

**NOTE:**

- Unequal tire pressures from side to side may cause erratic and unpredictable steering response.
- Unequal tire pressure from side to side may cause the vehicle to drift left or right.

**Tire Inflation Pressures**

The proper cold tire inflation pressure is listed on the driver's side B-Pillar or rear edge of the driver's side door.

At least once a month:

- Check and adjust tire pressure with a good quality pocket-type pressure gauge. Do not make a visual



judgement when determining proper inflation. Tires may look properly inflated even when they are under-inflated.

- Inspect tires for signs of tire wear or visible damage.

### CAUTION!

**After inspecting or adjusting the tire pressure, always reinstall the valve stem cap. This will prevent moisture and dirt from entering the valve stem, which could damage the valve stem.**

Inflation pressures specified on the placard are always “cold tire inflation pressure”. Cold tire inflation pressure is defined as the tire pressure after the vehicle has not been driven for at least three hours, or driven less than 1 mile (1.6 km) after a three hour period. The cold tire inflation pressure must not exceed the maximum inflation pressure molded into the tire sidewall.

Check tire pressures more often if subject to a wide range of outdoor temperatures, as tire pressures vary with temperature changes.

Tire pressures change by approximately 1 psi (7 kPa) per 12°F (7°C) of air temperature change. Keep this in mind when checking tire pressure inside a garage, especially in the winter.

Example: If garage temperature = 68°F (20°C) and the outside temperature = 32°F (0°C) then the cold tire inflation pressure should be increased by 3 psi (21 kPa), which equals 1 psi (7 kPa) for every 12°F (7°C) for this outside temperature condition.

Tire pressure may increase from 2 to 6 psi (13 to 40 kPa) during operation. DO NOT reduce this normal pressure build up or your tire pressure will be too low.

## Tire Pressures For High Speed Operation

The manufacturer advocates driving at safe speeds and within posted speed limits. Where speed limits or conditions are such that the vehicle can be driven at high speeds, maintaining correct tire inflation pressure is very important. Increased tire pressure and reduced vehicle loading may be required for high-speed vehicle operation. Refer to your authorized tire dealer or original equipment vehicle dealer for recommended safe operating speeds, loading and cold tire inflation pressures.

### **WARNING!**

**High speed driving with your vehicle under maximum load is dangerous. The added strain on your tires could cause them to fail. You could have a serious collision. Do not drive a vehicle loaded to the maximum capacity at continuous speeds above 75 mph (120 km/h).**

## Radial Ply Tires

### **WARNING!**

**Combining radial ply tires with other types of tires on your vehicle will cause your vehicle to handle poorly. The instability could cause a collision. Always use radial ply tires in sets of four. Never combine them with other types of tires.**

## Tire Repair

If your tire becomes damaged, it may be repaired if it meets the following criteria:

- The tire has not been driven on when flat.
- The damage is only on the tread section of your tire (sidewall damage is not repairable).
- The puncture is no greater than ¼" (6 mm).

Consult an authorized tire dealer for tire repairs and additional information.

Damaged Run Flat tires, or Run Flat tires that have experienced a loss of pressure should be replaced immediately with another Run Flat tire of identical size and service description (Load Index and Speed Code).

## **Tire Types**

### **All Season Tires — If Equipped**

All Season tires provide traction for all seasons (spring, summer, fall and winter). Traction levels may vary between different all season tires. All season tires can be identified by the M+S, M&S, M/S or MS designation on the tire sidewall. Use all season tires only in sets of four; failure to do so may adversely affect the safety and handling of your vehicle.

### **Summer Or Three Season Tires — If Equipped**

Summer tires provide traction in both wet and dry conditions, and are not intended to be driven in snow or on ice. If your vehicle is equipped with summer tires, be aware these tires are not designed for winter or cold driving conditions. For more information, contact a authorized dealer. Summer tires do not contain the all season designation or mountain/snowflake symbol on the tire sidewall.

Use summer tires only in sets of four; failure to do so may adversely affect the safety and handling of your vehicle.

### **Snow Tires**

Some areas of the country require the use of snow tires during the winter. Snow tires can be identified by a mountain/snowflake symbol on the tire sidewall.

If you need snow tires, select tires equivalent in size and type to the original equipment tires. Use snow tires only in sets of four; failure to do so may adversely affect the safety and handling of your vehicle.

Snow tires generally have lower speed ratings than what was originally equipped with your vehicle and should not be operated at sustained speeds over 75 mph (120 km/h). For speeds above 75 mph (120 km/h) refer to original equipment or an authorized tire dealer for recommended safe operating speeds, loading and cold tire inflation pressures.

While studded tires improve performance on ice, skid and traction capability on wet or dry surfaces may be poorer than that of non-studded tires. Some states prohibit studded tires; therefore, local laws should be checked before using these tire types.

### **Run Flat Tires — If Equipped**

Run Flat tires allow you the capability to drive 50 miles (80 km) at 50 mph (80 km/h) after a rapid loss of inflation pressure. This rapid loss of inflation is referred to as the Run Flat mode. A Run Flat mode occurs when the tire inflation pressure is of/or below 14 psi (96 kPa). Once a Run Flat tire reaches the run flat mode it has limited driving capabilities and needs to be replaced immediately. A Run Flat tire is not repairable.

It is not recommended driving a vehicle loaded at full capacity or to tow a trailer while a tire is in the run flat mode.

See the tire pressure monitoring section for more information.

## Spare Tires — If Equipped

**NOTE:** For vehicles equipped with TIREFIT instead of a spare tire, please refer to “TIREFIT KIT” in “What To Do In Emergencies” for further information.

### CAUTION!

**Because of the reduced ground clearance, do not take your vehicle through an automatic car wash with a compact, full size or limited-use temporary spare installed. Damage to the vehicle may result.**

## Spare Tire Matching Original Equipped Tire And Wheel — If Equipped

Your vehicle may be equipped with a spare tire and wheel equivalent in look and function to the original equipment tire and wheel found on the front or rear axle of your vehicle. This spare tire may be used in the tire

rotation for your vehicle. If your vehicle has this option, refer to an authorized tire dealer for the recommended tire rotation pattern.

## Compact Spare Tire — If Equipped

The compact spare is for temporary emergency use only. You can identify if your vehicle is equipped with a compact spare by looking at the spare tire description on the Tire and Loading Information Placard located on the driver’s side door opening or on the sidewall of the tire. Compact spare tire descriptions begin with the letter “T” or “S” preceding the size designation. Example: T145/80D18 103M.

T, S = Temporary Spare Tire

Since this tire has limited tread life, the original equipment tire should be repaired (or replaced) and reinstalled on your vehicle at the first opportunity.

Do not install a wheel cover or attempt to mount a conventional tire on the compact spare wheel, since the wheel is designed specifically for the compact spare tire. Do not install more than one compact spare tire and wheel on the vehicle at any given time.

### **WARNING!**

**Compact spares are for temporary emergency use only. With these spares, do not drive more than 50 mph (80 km/h). Temporary use spares have limited tread life. When the tread is worn to the tread wear indicators, the temporary use spare tire needs to be replaced. Be sure to follow the warnings, which apply to your spare. Failure to do so could result in spare tire failure and loss of vehicle control.**

#### **Full Size Spare — If Equipped**

The full size spare is for temporary emergency use only. This tire may look like the originally equipped tire on the

front or rear axle of your vehicle, but it is not. This spare tire may have limited tread life. When the tread is worn to the tread wear indicators, the temporary use full size spare tire needs to be replaced. Since it is not the same as your original equipment tire, replace (or repair) the original equipment tire and reinstall on the vehicle at the first opportunity.

#### **Limited-Use Spare — If Equipped**

The limited-use spare tire is for temporary emergency use only. This tire is identified by a label located on the limited-use spare wheel. This label contains the driving limitations for this spare. This tire may look like the original equipped tire on the front or rear axle of your vehicle, but it is not. Installation of this limited-use spare tire affects vehicle handling. Since it is not the same as your original equipment tire, replace (or repair) the original equipment tire and reinstall on the vehicle at the first opportunity.

**WARNING!**

Limited-use spares are for emergency use only. Installation of this limited-use spare tire affects vehicle handling. With this tire, do not drive more than the speed listed on the limit-use spare wheel. Keep inflated to the cold tire inflation pressures listed on your Tire and Loading Information Placard located on the driver's side B-Pillar or the rear edge of the driver's side door. Replace (or repair) the original equipment tire at the first opportunity and reinstall it on your vehicle. Failure to do so could result in loss of vehicle control.

**Tire Spinning**

When stuck in mud, sand, snow, or ice conditions, do not spin your vehicle's wheels above 30 mph (48 km/h) or for longer than 30 seconds continuously without stopping.

Refer to "Freeing A Stuck Vehicle" in "What To Do In Emergencies" for further information.

**WARNING!**

Fast spinning tires can be dangerous. Forces generated by excessive wheel speeds may cause tire damage or failure. A tire could explode and injure someone. Do not spin your vehicle's wheels faster than 30 mph (48 km/h) for more than 30 seconds continuously when you are stuck, and do not let anyone near a spinning wheel, no matter what the speed.

## Tread Wear Indicators

Tread wear indicators are in the original equipment tires to help you in determining when your tires should be replaced.



055007576

1 — Worn Tire  
2 — New Tire

---

These indicators are molded into the bottom of the tread grooves. They will appear as bands when the tread depth becomes 1/16 in (2 mm). When the tread is worn to the tread wear indicators, the tire should be replaced. Refer to “Replacement Tires” in this section for further information.

## Life Of Tire

The service life of a tire is dependent upon varying factors including, but not limited to:

- Driving style
- Tire pressure
- Distance driven
- Performance tires, tires with a speed rating of V or higher, and summer tires typically have a reduced tread life. Rotation of these tires per the vehicle maintenance schedule is highly recommended.



**WARNING!**

**Tires and the spare tire should be replaced after six years, regardless of the remaining tread. Failure to follow this warning can result in sudden tire failure. You could lose control and have a collision resulting in serious injury or death.**

Keep dismounted tires in a cool, dry place with as little exposure to light as possible. Protect tires from contact with oil, grease, and gasoline.

**Replacement Tires**

The tires on your new vehicle provide a balance of many characteristics. They should be inspected regularly for wear and correct cold tire inflation pressure. The manufacturer strongly recommends that you use tires equivalent to the originals in size, quality and performance when replacement is needed. Refer to the paragraph on “Tread Wear Indicators”. Refer to the Tire and Loading

Information placard or the Vehicle Certification Label for the size designation of your tire. The Load Index and Speed Symbol for your tire will be found on the original equipment tire sidewall. See the Tire Sizing Chart example found in the Tire Safety Information section of this manual for more information relating to the Load Index and Speed Symbol of a tire.

It is recommended to replace the two front tires or two rear tires as a pair. Replacing just one tire can seriously affect your vehicle’s handling. If you ever replace a wheel, make sure that the wheel’s specifications match those of the original wheels.

It is recommended you contact your authorized tire dealer or original equipment dealer with any questions you may have on tire specifications or capability. Failure to use equivalent replacement tires may adversely affect the safety, handling, and ride of your vehicle.

**WARNING!**

- Do not use a tire, wheel size or rating other than that specified for your vehicle. Some combinations of unapproved tires and wheels may change suspension dimensions and performance characteristics, resulting in changes to steering, handling, and braking of your vehicle. This can cause unpredictable handling and stress to steering and suspension components. You could lose control and have a collision resulting in serious injury or death. Use only the tire and wheel sizes with load ratings approved for your vehicle.
- Never use a tire with a smaller load index or capacity, other than what was originally equipped on your vehicle. Using a tire with a smaller load index could result in tire overloading and failure. You could lose control and have a collision.

*(Continued)*

**WARNING! (Continued)**

- Failure to equip your vehicle with tires having adequate speed capability can result in sudden tire failure and loss of vehicle control.

**CAUTION!**

Replacing original tires with tires of a different size may result in false speedometer and odometer readings.

**TIRE CHAINS (TRACTION DEVICES)**

Use of traction devices require sufficient tire-to-body clearance. Follow these recommendations to guard against damage.

- Traction device must be of proper size for the tire, as recommended by the traction device manufacturer

- Install on Front Tires
- Due to limited clearance, a 225/45R17 tire with a Security Chain Company (SCC) Super Z6 low profile traction device or equivalent is recommended

**WARNING!**

Using tires of different size and type (M+S, Snow) between front and rear axles can cause unpredictable handling. You could lose control and have a collision.

**CAUTION!**

To avoid damage to your vehicle or tires, observe the following precautions:

*(Continued)*

**CAUTION! (Continued)**

- Because of restricted traction device clearance between tires and other suspension components, it is important that only traction devices in good condition are used. Broken devices can cause serious damage. Stop the vehicle immediately if noise occurs that could indicate device breakage. Remove the damaged parts of the device before further use.
- Install device as tightly as possible and then re-tighten after driving about ½ mile (0.8 km).
- Do not exceed 30 mph (48 km/h).
- Drive cautiously and avoid severe turns and large bumps, especially with a loaded vehicle.
- Do not drive for prolonged period on dry pavement.

*(Continued)*

**CAUTION!** *(Continued)*

- **Observe the traction device manufacturer's instructions on the method of installation, operating speed, and conditions for use. Always use the suggested operating speed of the device manufacturer's if it is less than 30 mph (48 km/h).**
- **Do not use traction devices on a compact spare tire.**

**TIRE ROTATION RECOMMENDATIONS**

The tires on the front and rear of your vehicle operate at different loads and perform different steering, driving, and braking functions. For these reasons, they wear at unequal rates.

These effects can be reduced by timely rotation of tires. The benefits of rotation are especially worthwhile with aggressive tread designs such as those on all season type tires. Rotation will increase tread life, help to maintain mud, snow and wet traction levels, and contribute to a smooth, quiet ride.

Refer to the "Maintenance Schedule" for the proper maintenance intervals. The reasons for any rapid or unusual wear should be corrected prior to rotation being performed.

The suggested rotation method is the “rearward cross” shown in the following diagram. This rotation pattern does not apply to some directional tires that must not be reversed.

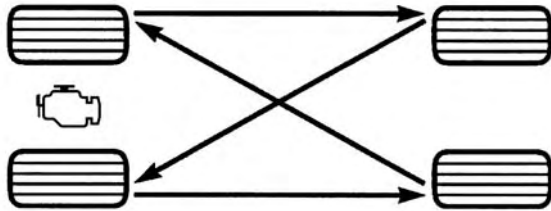

Tire Rotation

055707139

## TIRE PRESSURE MONITORING SYSTEM (TPMS)

The Tire Pressure Monitor System (TPMS) will warn the driver of a low tire pressure based on the vehicle recommended cold placard pressure.

The tire pressure will vary with temperature by about 1 psi (7.0 kPa) for every 12°F (6.5°C). This means that when the outside temperature decreases, the tire pressure will decrease. Tire pressure should always be set based on “cold inflation tire pressure”. This is defined as the tire pressure after the vehicle has not been driven for at least three hours, or driven less than 1 mile (1.6 km) after a three hour period. The cold tire inflation pressure must not exceed the maximum inflation pressure molded into the tire sidewall. Refer to “Tires – General Information” in “Starting and Operating” for information on how to properly inflate the vehicle’s tires. The tire pressure will

also increase as the vehicle is driven - this is normal and there should be no adjustment for this increased pressure.

The TPMS will warn the driver of a low tire pressure if the tire pressure falls below the low-pressure warning limit for any reason, including low temperature effects, or natural pressure loss through the tire.

The TPMS will continue to warn the driver of low tire pressure as long as the condition exists, and will not turn off until the tire pressure is at or above the recommended cold placard pressure. Once the low tire pressure warning (Tire Pressure Monitoring Telltale Light) illuminates, you must increase the tire pressure to the recommended cold placard pressure in order for the Tire Pressure Monitoring Telltale Light to turn off. The system will automatically update and the Tire Pressure Monitoring Telltale Light will turn off once the system receives the updated tire pressures. The vehicle may need to be

driven for up to 20 minutes above 15 mph (24 km/h) in order for the TPMS to receive this information.

For example, your vehicle may have a recommended cold (parked for more than three hours) placard pressure of 30 psi (207 kPa). If the ambient temperature is 68°F (20°C) and the measured tire pressure is 27 psi (186 kPa), a temperature drop to 20°F (-7°C) will decrease the tire pressure to approximately 23 psi (158 kPa). This tire pressure is sufficiently low enough to turn ON the Tire Pressure Monitoring Telltale Light. Driving the vehicle may cause the tire pressure to rise to approximately 27 psi (186 kPa), but the Tire Pressure Monitoring Telltale Light will still be ON. In this situation, the Tire Pressure Monitoring Telltale Light will turn OFF only after the tires are inflated to the vehicle's recommended cold placard pressure value.

**CAUTION!**

- The TPMS has been optimized for the original equipment tires and wheels. TPMS pressures and warning have been established for the tire size equipped on your vehicle. Undesirable system operation or sensor damage may result when using replacement equipment that is not of the same size, type, and/or style. Aftermarket wheels can cause sensor damage. Using aftermarket tire sealants may cause the Tire Pressure Monitoring System (TPMS) sensor to become inoperable. After using an aftermarket tire sealant it is recommended that you take your vehicle to an authorized dealership to have your sensor function checked.

*(Continued)*

**CAUTION! (Continued)**

- After inspecting or adjusting the tire pressure, always reinstall the valve stem cap. This will prevent moisture and dirt from entering the valve stem, which could damage the Tire Pressure Monitoring Sensor.

**NOTE:**

- The TPMS is not intended to replace normal tire care and maintenance or to provide warning of a tire failure or condition.
- The TPMS should not be used as a tire pressure gauge while adjusting your tire pressure.
- Driving on a significantly under-inflated tire causes the tire to overheat and can lead to tire failure.

Under-inflation also reduces fuel efficiency and tire tread life, and may affect the vehicle's handling and stopping ability.

- The TPMS is not a substitute for proper tire maintenance, and it is the driver's responsibility to maintain correct tire pressure using an accurate tire gauge, even if under-inflation has not reached the level to trigger illumination of the Tire Pressure Monitoring Telltale Light.
- Seasonal temperature changes will affect tire pressure, and the TPMS will monitor the actual tire pressure in the tire.

### Base System



This is the TPMS warning indicator located in the instrument cluster.

The TPMS uses wireless technology with wheel rim mounted electronic sensors to monitor tire pressure levels. Sensors, mounted to each wheel as part of the valve stem, transmit tire pressure readings to the Receiver Module.

**NOTE:** It is particularly important for you to check the tire pressure in all of the tires on your vehicle regularly and to maintain the proper pressure.

The TPMS consists of the following components:

- Receiver Module.
- Four Tire Pressure Monitoring Sensors.
- Tire Pressure Monitoring Telltale Light.

### Tire Pressure Monitoring Low Pressure Warnings

The Tire Pressure Monitoring Telltale Light will illuminate in the instrument cluster, a "LOW TIRE PRESSURE"



message and “Inflate Tire to XX” message will be displayed for a minimum of five seconds, and an audible chime will be activated when one or more of the four active road tire pressures are low. Should this occur, you should stop as soon as possible, check the inflation pressure of each tire on your vehicle, and inflate each tire to the vehicle’s recommended cold placard pressure value. The recommended cold placard pressure value is the pressure value in the “Inflate Tire to XX” message displayed in the EVIC. The system will automatically update and the Tire Pressure Monitoring Light will extinguish and the “LOW TIRE PRESSURE” and “Inflate Tire to XX” messages will turn off once the updated tire pressures have been received. The vehicle may need to be driven for up to 20 minutes above 15 mph (24 km/h) to receive this information.

### Service TPMS Warnings

The Tire Pressure Monitoring Telltale Light will flash on and off for 75 seconds and then remain on solid when a system fault is detected. The system fault will also sound a chime and display a “SERVICE TPM SYSTEM” message for a minimum of five seconds. If the ignition key is cycled, this sequence will repeat providing the system fault still exists. The Tire Pressure Monitoring Telltale Light will turn off when the fault condition no longer exists. A system fault can occur with any of the following scenarios:

1. Jamming due to electronic devices or driving next to facilities emitting the same radio frequencies as the TPM sensors.
2. Installing some form of aftermarket window tinting that affects radio wave signals.
3. Snow or ice around the wheels or wheel housings.

4. Using tire chains on the vehicle.
5. Using wheels/tires not equipped with TPM sensors.

**NOTE:** Your vehicle is equipped with a compact spare wheel and tire assembly.

1. The compact spare tire does not have a tire pressure monitoring sensor. Therefore, the TPMS will not monitor the tire pressure in the compact spare tire.
2. If you install the compact spare tire in place of a road tire that has a pressure below the low-pressure warning limit, upon the next ignition key cycle, a chime will sound and the Tire Pressure Monitoring Telltale Light and "LOW TIRE PRESSURE" and "Inflate Tire to XX" messages will still turn ON due to the low tire.
3. However, after driving the vehicle for up to 20 minutes above 15 mph (24 km/h), the Tire Pressure Monitoring Telltale Light will flash on and off for 75 seconds and then remain on solid and a "SERVICE TPM SYSTEM" message will be displayed for a minimum of five seconds.
4. For each subsequent ignition key cycle, a chime will sound and the Tire Pressure Monitoring Telltale Light will flash on and off for 75 seconds and then remain on solid and a "SERVICE TPM SYSTEM" message will be displayed for a minimum of five seconds.
5. Once you repair or replace the original road tire and reinstall it on the vehicle in place of the compact spare tire, the TPMS will update automatically and the Tire Pressure Monitoring Telltale Light will turn OFF, as long as no tire pressure is below the low-pressure warning limit in any of the four active road tires. The vehicle may need to be driven for up to 20 minutes above 15 mph (24 km/h) in order for the TPMS to receive this information.

## Premium System — If Equipped

The TPMS uses wireless technology with wheel rim mounted electronic sensors to monitor tire pressure levels. Sensors, mounted to each wheel as part of the valve stem, transmit tire pressure readings to the receiver module.

**NOTE:** It is particularly important for you to check the tire pressure in all of your tires regularly and to maintain the proper pressure.

The TPMS consists of the following components:

- Receiver Module
- Four Tire Pressure Monitoring Sensors
- Various Tire Pressure Monitoring System Messages, which display in the Electronic Vehicle Information Center (EVIC)
- Tire Pressure Monitoring Telltale Light

## Tire Pressure Monitoring Low Pressure Warnings

The Tire Pressure Monitoring Telltale Light will illuminate in the instrument cluster and an audible chime will be activated when one or more of the four active road tire pressures are low. The audible chime will sound once every ignition cycle for the first condition that it detects. In addition, the EVIC will display a “Inflate Tire to XX” message for a minimum of five seconds and a graphic of the pressure value(s) with the low tire(s) flashing or displayed in a different color. The recommended cold placard pressure inflation value is the pressure value displayed in the “Inflate Tire to XX” message displayed in the EVIC.

Should a low tire condition occur on any of the four active road tire(s), you should stop as soon as possible and inflate all tires that are flashing or in a different color on the graphic display to the vehicle’s recommended

cold placard pressure value. The system will automatically update, the "Inflate Tire to XX" message will no longer be displayed, the graphic display of the pressure value(s) will stop flashing or return to their normal color, and the Tire Pressure Monitoring Light will extinguish once the updated tire pressure(s) have been received. The vehicle may need to be driven for up to 20 minutes above 15 mph (24 km/h) to receive this information.

### Service TPMS Message

The Tire Pressure Monitoring Telltale Light will flash on and off for 75 seconds, and then remain on solid when a system fault is detected. The system fault will also sound a chime. The EVIC will display a "SERVICE TPM SYSTEM" message for a minimum of five seconds. This text message is then followed by a graphic display, with "--" in place of the pressure value(s) indicating which Tire Pressure Monitoring Sensor(s) is not being received.

If the ignition key is cycled, this sequence will repeat, providing the system fault still exists. If the system fault no longer exists, the Tire Pressure Monitoring Telltale Light will no longer flash, the "SERVICE TPM SYSTEM" message will not be present, and a pressure value will be displayed instead of dashes. A system fault can occur with any of the following scenarios:

1. Jamming due to electronic devices or driving next to facilities emitting the same radio frequencies as the TPM sensors.
2. Installing some form of aftermarket window tinting that affects radio wave signals.
3. Snow or ice around the wheels or wheel housings.
4. Using tire chains on the vehicle.
5. Using wheels/tires not equipped with TPM sensors.

**NOTE:** Your vehicle is equipped with a compact spare wheel and tire assembly.

1. The compact spare tire does not have a tire pressure monitoring sensor. Therefore, the TPMS will not monitor the tire pressure in the compact spare tire.
2. If you install the compact spare tire in place of a road tire that has a pressure below the low-pressure warning limit, upon the next ignition key cycle, a chime will sound and the Tire Pressure Monitoring Telltale Light will still turn ON due to the low tire. The “Inflate Tire to XX” message and the graphic with the low tire pressure flashing or in a different color will be displayed.
3. However, after driving the vehicle for up to 20 minutes above 15 mph (24 km/h), the Tire Pressure Monitoring Telltale Light will flash on and off for 75 seconds and then remain on solid. In addition, the EVIC will display a “SERVICE TPM SYSTEM” message for a minimum of five seconds and then display dashes (- -) in place of the pressure values.
4. For each subsequent ignition key cycle, a chime will sound and the Tire Pressure Monitoring Telltale Light will flash on and off for 75 seconds and then remain on solid, and the EVIC will display a “SERVICE TPM SYSTEM” message for a minimum of five seconds and then display dashes (- -) in place of the pressure values.
5. Once you repair or replace the original road tire and reinstall it on the vehicle in place of the compact spare tire, the TPMS will update automatically and the Tire Pressure Monitoring Telltale Light will turn OFF, as long as no tire pressure is below the low-pressure warning limit in any of the four active road tires. The

vehicle may need to be driven for up to 20 minutes above 15 mph (24 km/h) in order for the TPMS to receive this information.

### General Information

This device complies with Part 15 of the FCC rules and RSS 210 of Industry Canada. Operation is subject to the following conditions:

- This device may not cause harmful interference.
- This device must accept any interference received, including interference that may cause undesired operation.

The tire pressure sensors are covered under one of the following licenses:

United States	KR55WY9012
Canada	7812D-5WY9012

## FUEL REQUIREMENTS

### 1.4L Turbo Engine



This engine is designed to meet all emission regulations and provide satisfactory fuel economy and performance when using high-quality unleaded "regular" gasoline having an octane rating of 87. For optimum performance and fuel economy the use of 91 octane or higher is recommended.

### 2.0L And 2.4L Engine



This engine is designed to meet all emissions regulations and provide excellent fuel economy and performance when using high-quality unleaded "regular" gasoline having an octane rating of 87.

Light spark knock at low engine speeds is not harmful to your engine. However, continued heavy spark knock at high speeds can cause damage and immediate service is required. Poor quality gasoline can cause problems such as hard starting, stalling, and hesitations. If you experience these symptoms, try another brand of gasoline before considering service for the vehicle.

Over 40 auto manufacturers worldwide have issued and endorsed consistent gasoline specifications (the Worldwide Fuel Charter, WWFC) which define fuel properties necessary to deliver enhanced emissions, performance, and durability for your vehicle. The manufacturer recommends the use of gasolines that meet the WWFC specifications if they are available.

## **Reformulated Gasoline**

Many areas of the country require the use of cleaner burning gasoline referred to as “Reformulated Gasoline.” Reformulated gasoline contains oxygenates and are specifically blended to reduce vehicle emissions and improve air quality.

The manufacturer supports the use of reformulated gasoline. Properly blended reformulated gasoline will provide excellent performance and durability of engine and fuel system components.

## **Gasoline/Oxygenate Blends**

Some fuel suppliers blend unleaded gasoline with oxygenates such as Ethanol. Fuels blended with oxygenates may be used in your vehicle.

**CAUTION!**

**DO NOT use gasoline containing Methanol or gasoline containing more than 10% Ethanol. Use of these blends may result in starting and drivability problems, damage critical fuel system components, cause emissions to exceed the applicable standard, and/or cause the "Malfunction Indicator Light" to illuminate. Pump labels should clearly communicate if a fuel contains greater than 10% Ethanol.**

Problems that result from using gasoline containing Methanol or gasoline containing more than 10% Ethanol are not the responsibility of the manufacturer and may not be covered under New Vehicle Limited Warranty.

**E-85 Usage In Non-Flex Fuel Vehicles**

Non-Flex Fuel (FFV) vehicles are compatible with gasoline containing 10% ethanol (E10). Gasoline with higher ethanol content may void the vehicle's warranty.

If a Non-FFV vehicle is inadvertently fueled with E-85 fuel, the engine will have some or all of these symptoms:

- Operate in a lean mode
- OBD II "Malfunction Indicator Light" on
- Poor engine performance
- Poor cold start and cold driveability
- Increased risk for fuel system component corrosion

To fix a Non-FFV vehicle inadvertently fueled once with E-85 perform the following:

- Change the engine oil and oil filter
- Disconnect and reconnect the battery
- Drain the fuel tank (see your authorized dealer)

More extensive repairs will be required for prolonged exposure to E-85 fuel.



## MMT In Gasoline

MMT (Methylcyclopentadienyl Manganese Tricarbonyl) is a manganese-containing metallic additive that is blended into some gasoline to increase octane. Gasoline blended with MMT provides no performance advantage beyond gasoline of the same octane number without MMT. Gasoline blended with MMT reduces spark plug life and reduces emissions system performance in some vehicles. The manufacturer recommends that gasoline without MMT be used in your vehicle. The MMT content of gasoline may not be indicated on the gasoline pump, therefore, you should ask your gasoline retailer whether the gasoline contains MMT. MMT is prohibited in Federal and California reformulated gasoline.

## Materials Added To Fuel

All gasoline sold in the United States is required to contain effective detergent additives. Use of additional detergents or other additives is not needed under normal

conditions and they would result in additional cost. Therefore, you should not have to add anything to the fuel.

## Fuel System Cautions

### CAUTION!

Follow these guidelines to maintain your vehicle's performance:

- The use of leaded gas is prohibited by Federal law. Using leaded gasoline can impair engine performance and damage the emissions control system.

*(Continued)*

**CAUTION!** *(Continued)*

- An out-of-tune engine or certain fuel or ignition malfunctions can cause the catalytic converter to overheat. If you notice a pungent burning odor or some light smoke, your engine may be out of tune or malfunctioning and may require immediate service. Contact your authorized dealer for service assistance.
- The use of fuel additives, which are now being sold as octane enhancers, is not recommended. Most of these products contain high concentrations of methanol. Fuel system damage or vehicle performance problems resulting from the use of such fuels or additives is not the responsibility of the manufacturer.

**NOTE:** Intentional tampering with the emissions control system can result in civil penalties being assessed against you.

**Carbon Monoxide Warnings****WARNING!**

Carbon monoxide (CO) in exhaust gases is deadly. Follow the precautions below to prevent carbon monoxide poisoning:

- Do not inhale exhaust gases. They contain carbon monoxide, a colorless and odorless gas, which can kill. Never run the engine in a closed area, such as a garage, and never sit in a parked vehicle with the engine running for an extended period. If the vehicle is stopped in an open area with the engine running for more than a short period, adjust the ventilation system to force fresh, outside air into the vehicle.

*(Continued)*

**WARNING! (Continued)**

- Guard against carbon monoxide with proper maintenance. Have the exhaust system inspected every time the vehicle is raised. Have any abnormal conditions repaired promptly. Until repaired, drive with all side windows fully open.
- Keep the trunk closed when driving your vehicle to prevent carbon monoxide and other poisonous exhaust gases from entering the vehicle.

**ADDING FUEL****Fuel Filler Cap (Gas Cap)**

The gas cap is located behind the locking fuel filler door, on the right side of the vehicle. If the gas cap is lost or damaged, be sure the replacement cap is for use with this vehicle.

1. Press the fuel filler door release switch (located on the driver's side door trim).
2. Open the fuel filler door, and remove the fuel filler cap.

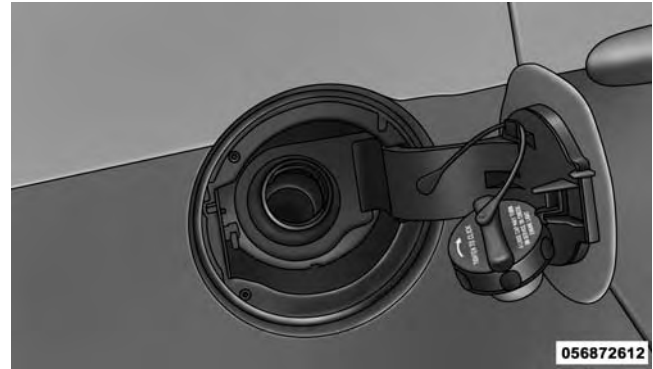
**Fuel Filler Cap**

**NOTE:** In certain cold conditions, ice may prevent the fuel door from opening. If this occurs, lightly push on the fuel door to break the ice buildup and re-release the fuel door using the inside release button. Do not pry on the door.

3. Hang cap by tether on fill door to prevent damage to body side.

**CAUTION!**

- Damage to the fuel system or emission control system could result from using an improper fuel cap (gas cap). A poorly fitting cap could let impurities into the fuel system. Also, a poorly fitting aftermarket cap can cause the "Malfunction Indicator Light (MIL)" to illuminate, due to fuel vapors escaping from the system.
- A poorly fitting gas cap may cause the MIL to turn on.

**CAUTION! (Continued)**

- To avoid fuel spillage and overfilling, do not "top off" the fuel tank after filling.

**WARNING!**

- Never have any smoking materials lit in or near the vehicle when the gas cap is removed or the tank is being filled.
- Never add fuel when the engine is running. This is in violation of most state and federal fire regulations and may cause the malfunction indicator light to turn on.
- A fire may result if gasoline is pumped into a portable container that is inside of a vehicle. You could be burned. Always place gas containers on the ground while filling.

*(Continued)*

**NOTE:**

- When the fuel nozzle “clicks” or shuts off, the fuel tank is full.
- Tighten the gas cap about one-quarter turn until you hear one click. This is an indication that the cap is properly tightened.
- If the gas cap is not tightened properly, the MIL will come on. Be sure the gas cap is tightened every time the vehicle is refueled.

**Manual Fuel Filler Door Release**

If you are unable to open the fuel filler door, use the manual fuel filler door release.

1. Open the trunk.
2. Locate the release cable access door cut out on the right side of the trunk trim.

3. Insert finger into half circle opening and pull flap open to access the cable.

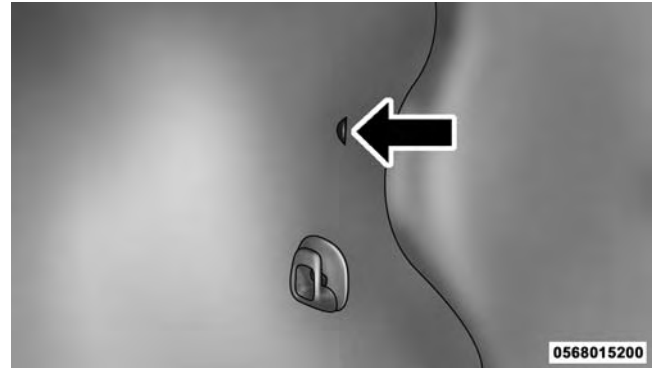

**Release Cable Access Door Cut Out**

4. Pull the release cable.

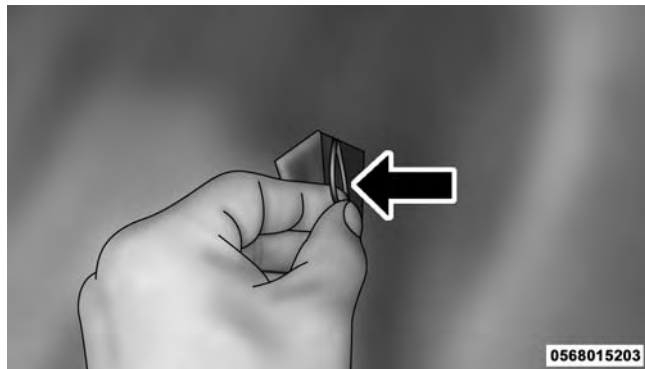

Release Cable

## VEHICLE LOADING

As required by National Highway Traffic Safety Administration regulations, your vehicle has a certification label affixed to the driver's side door or B-Pillar.

## Vehicle Certification Label

Your vehicle has a Vehicle Certification Label attached to the driver's door B-Pillar.

The label contains the following information:

- Name of manufacturer
- Month and year of manufacture
- Gross Vehicle Weight Rating (GVWR)
- Vehicle Identification Number (VIN)
- Type of Vehicle
- Month, Day and Hour of Manufacture (MDH)

The bar code allows a computer scanner to read the Vehicle Identification Number (VIN).

## **Gross Vehicle Weight Rating (GVWR)**

The GVWR is the total allowable weight of your vehicle. This includes driver, passengers, and cargo. The total load must be limited so that you do not exceed the GVWR.

## **Tire Size**

The tire size on the Vehicle Certification Label represents the actual tire size on your vehicle. Replacement tires must be equal to the load capacity of this tire size.

## **Rim Size**

This is the rim size that is appropriate for the tire size listed.

## **Inflation Pressure**

This is the cold tire inflation pressure for your vehicle for all loading conditions up to full GAWR.

## **Curb Weight**

The curb weight of a vehicle is defined as the total weight of the vehicle with all fluids, including vehicle fuel, at full capacity conditions, and with no occupants or cargo loaded into the vehicle. The front and rear curb weight values are determined by weighing your vehicle on a commercial scale before any occupants or cargo are added.

## **Overloading**

The load carrying components (springs, tires, wheels, etc.) of your vehicle will provide satisfactory service as long as you do not exceed the GVWR.

The best way to figure out the total weight of your vehicle is to weigh it when it is fully loaded and ready for operation. Weigh it on a commercial scale to ensure that it is not over the GVWR.

Overloading can cause potential safety hazards and shorten useful service life. Heavier suspension components do not necessarily increase the vehicle's GVWR.

### Loading

To load your vehicle properly, first figure out its empty weight. Store heavier items down low and be sure you distribute their weight as evenly as possible. Stow all loose items securely before driving. Improper weight distribution can have an adverse effect on the way your vehicle steers and handles, and the way the brakes operate.

#### **CAUTION!**

**Do not load your vehicle any heavier than the GVWR. If you do, parts on your vehicle can break, or it can change the way your vehicle handles. This could cause you to lose control. Also, overloading can shorten the life of your vehicle.**

### TRAILER TOWING

In this section you will find safety tips and information on limits to the type of towing you can reasonably do with your vehicle. Before towing a trailer, carefully review this information to tow your load as efficiently and safely as possible.

To maintain the New Vehicle Limited Warranty coverage, follow the requirements and recommendations in this manual concerning vehicles used for trailer towing.

#### Common Towing Definitions

The following trailer towing related definitions will assist you in understanding the following information:

#### Gross Vehicle Weight Rating (GVWR)

The GVWR is the total allowable weight of your vehicle. This includes driver, passengers, cargo and tongue weight. The total load must be limited so that you do not



exceed the GVWR. Refer to “Vehicle Loading/Vehicle Certification Label” in “Starting and Operating” for further information.

### **Gross Trailer Weight (GTW)**

The GTW is the weight of the trailer plus the weight of all cargo, consumables and equipment (permanent or temporary) loaded in or on the trailer in its “loaded and ready for operation” condition. The recommended way to measure GTW is to put your fully loaded trailer on a vehicle scale. The entire weight of the trailer must be supported by the scale.

### **Gross Combination Weight Rating (GCWR)**

The GCWR is the total permissible weight of your vehicle and trailer when weighed in combination.

### **Gross Axle Weight Rating (GAWR)**

The GAWR is the maximum capacity of the front and rear axles. Distribute the load over the front and rear axles evenly. Make sure that you do not exceed either the front or rear GAWR. Refer to “Vehicle Loading/Vehicle Certification Label” in “Starting and Operating” for further information.

**WARNING!**

**It is important that you do not exceed the maximum front or rear GAWR. A dangerous driving condition can result if either rating is exceeded. You could lose control of the vehicle and have a collision.**

**Tongue Weight (TW)**

The tongue weight is the downward force exerted on the hitch ball by the trailer. In most cases it should not be less than 10% of the trailer load. You must consider this as part of the load on your vehicle.

**Frontal Area**

The frontal area is the maximum height multiplied by the maximum width of the front of a trailer.

**Trailer Sway Control**

The trailer sway control is a telescoping link that can be installed between the hitch receiver and the trailer tongue that typically provides adjustable friction associated with the telescoping motion to dampen any unwanted trailer swaying motions while traveling.

**Weight-Carrying Hitch**

A weight-carrying hitch supports the trailer tongue weight, just as if it were luggage located at a hitch ball or some other connecting point of the truck. These kind of hitches are the most popular on the market today and they are commonly used to tow small- and medium-sized trailers.

**Weight-Distributing Hitch**

A weight-distributing hitch system works by applying leverage through spring (load) bars. They are typically used for heavier loads, to distribute trailer tongue weight

to the tow vehicle's front axle and the trailer axle(s). When used in accordance with the manufacturer's directions, it provides for a more level ride, offering more consistent steering and brake control and thereby enhancing towing safety. The addition of a friction/hydraulic sway control also dampens sway caused by traffic and crosswinds, contributing positively to tow vehicle and trailer stability. Trailer sway control and a weight distributing (load equalizing) hitch are recommended for heavier Tongue Weights (TW) and may be required depending on Vehicle and Trailer configuration/loading to comply with GAWR requirements.

### Trailer Hitch Classification

The following chart provides the industry standard for the maximum trailer weight a given trailer hitch class can tow and should be used to assist you in selecting the correct trailer hitch for your intended towing condition.

Refer to the Trailer Towing Weights (Maximum Trailer Weight Ratings) chart for the Maximum GTW towable for your given drivetrain.

Trailer Hitch Classification Definitions	
Class	Max. Trailer Hitch Industry Standards
Class I - Light Duty	2,000 lbs (907 kg)
Class II - Medium Duty	3,500 lbs (1 587 kg)
Class III - Heavy Duty	5,000 lbs (2 268 kg)
Class IV - Extra Heavy Duty	10,000 lbs (4 540 kg)
Refer to the "Trailer Towing Weights (Maximum Trailer Weight Ratings)" chart for the Maximum Gross Trailer Weight (GTW) towable for your given drivetrain.	

All trailer hitches should be professionally installed on your vehicle.

**Trailer Towing Weights (Maximum Trailer Weight Ratings)****1.4L Turbo Engine**

Trailer towing is not recommended.

The following chart provides the maximum trailer weight ratings towable for your given drivetrain.

<b>Engine/Transmission</b>	<b>Frontal Area</b>	<b>Max. GTW (Gross Trailer Wt.)</b>	<b>Max. Tongue Wt. (See Note)</b>
2.0L and 2.4L Auto/ Man	22 sq ft (2.04 sq m)	1,000 lbs (450 kg)	150 lbs (50 kg)

Refer to local laws for maximum trailer towing speeds.

**NOTE: The trailer tongue weight must be considered as part of the combined weight of occupants and cargo and should never exceed the weight referenced on the Tire and Loading Information placard. Refer to "Tire Safety Information" in "Starting and Operating" for further information.**

## Trailer And Tongue Weight

Always load a trailer with 60% to 65% of the weight in the front of the trailer. This places 10% to 15% of the GTW on the tow hitch of your vehicle. Loads balanced over the wheels or heavier in the rear can cause the trailer to sway **severely** from side-to-side which will cause loss of control of vehicle and trailer. Failure to load trailers heavier in front is the cause of many trailer collisions.

Never exceed the maximum tongue weight stamped on your bumper or trailer hitch.

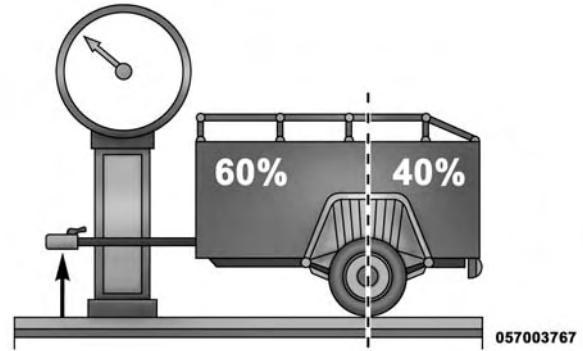

Consider the following items when computing the weight on the rear axle of the vehicle:

- The tongue weight of the trailer.
- The weight of any other type of cargo or equipment put in or on your vehicle.
- The weight of the driver and all passengers.

**NOTE:** Remember that everything put into or on the trailer adds to the load on your vehicle. Also, additional factory-installed options, or dealer-installed options, must be considered as part of the total load on your vehicle. Refer to the “Tire and Loading Information Placard” in “Tire Safety Information” for the maximum combined weight of occupants and cargo for your vehicle.

## Towing Requirements

To promote proper break-in of your new vehicle drive-train components, the following guidelines are recommended:

### CAUTION!

- **Do not tow a trailer at all during the first 500 miles (805 km) the new vehicle is driven. The engine, axle or other parts could be damaged.**
- **Then, during the first 500 miles (805 km) that a trailer is towed, do not drive over 50 mph (80 km/h) and do not make starts at full throttle. This helps the engine and other parts of the vehicle wear in at the heavier loads.**

Perform the maintenance listed in the Maintenance Schedule. Refer to "Maintenance Schedule" for further information. When towing a trailer, never exceed the GAWR or GCWR ratings.

**WARNING!**

Improper towing can lead to a collision. Follow these guidelines to make your trailer towing as safe as possible:

- Make certain that the load is secured in the trailer and will not shift during travel. When trailering cargo that is not fully secured, dynamic load shifts can occur that may be difficult for the driver to control. You could lose control of your vehicle and have a collision.

*(Continued)*

**WARNING! (Continued)**

- When hauling cargo or towing a trailer, do not overload your vehicle or trailer. Overloading can cause a loss of control, poor performance or damage to the brakes, axle, engine, transmission, steering, suspension, chassis structure or tires.
- Safety chains must always be used between your vehicle and trailer. Always connect the chains to the frame or hook retainers of the vehicle hitch. Cross the chains under the trailer tongue and allow enough slack for turning corners.
- Vehicles with trailers should not be parked on a grade. When parking, apply the parking brake on the tow vehicle. Put the tow vehicle automatic transmission in PARK. With a manual transmission, shift the transmission into REVERSE. Always block or "chock" the trailer wheels.

*(Continued)*

**WARNING! (Continued)**

- GCWR must not be exceeded.
- Total weight must be distributed between the tow vehicle and the trailer such that the following four ratings are not exceeded:

GVWR

GTW

GAWR

Tongue weight rating for the trailer hitch utilized.

**Towing Requirements — Tires**

- Do not attempt to tow a trailer while using a compact spare tire.
- Proper tire inflation pressures are essential to the safe and satisfactory operation of your vehicle. Refer to “Tires – General Information” in “Starting and Operating” for proper tire inflation procedures.

- Check the trailer tires for proper tire inflation pressures before trailer usage.
- Check for signs of tire wear or visible tire damage before towing a trailer. Refer to “Tires – General Information” in “Starting and Operating” for the proper inspection procedure.
- When replacing tires, refer to “Tires – General Information” in “Starting and Operating” for proper tire replacement procedures. Replacing tires with a higher load carrying capacity will not increase the vehicle’s GVWR and GAWR limits.

**Towing Requirements — Trailer Brakes**

- Do **not** interconnect the hydraulic brake system or vacuum system of your vehicle with that of the trailer. This could cause inadequate braking and possible personal injury.



- An electronically actuated trailer brake controller is required when towing a trailer with electronically actuated brakes. When towing a trailer equipped with a hydraulic surge actuated brake system, an electronic brake controller is not required.
- Trailer brakes are recommended for trailers over 1,000 lbs (450 kg) and required for trailers in excess of 2,000 lbs (907 kg).

### CAUTION!

If the trailer weighs more than 1,000 lbs (450 kg) loaded, it should have its own brakes and they should be of adequate capacity. Failure to do this could lead to accelerated brake lining wear, higher brake pedal effort, and longer stopping distances.

### WARNING!

- Do not connect trailer brakes to your vehicle's hydraulic brake lines. It can overload your brake system and cause it to fail. You might not have brakes when you need them and could have a collision.
- Towing any trailer will increase your stopping distance. When towing, you should allow for additional space between your vehicle and the vehicle in front of you. Failure to do so could result in a collision.

### Towing Requirements — Trailer Lights And Wiring

Whenever you pull a trailer, regardless of the trailer size, stop lights and turn signals on the trailer are required for motoring safety.

## 512 STARTING AND OPERATING

The Trailer Tow Package may include a four-pin and seven-pin wiring harness. Use a factory approved trailer harness and connector.

**NOTE:** Do not cut or splice wiring into the vehicle's wiring harness.

The electrical connections are all complete to the vehicle, but you must mate the harness to a trailer connector. Refer to the following illustrations.

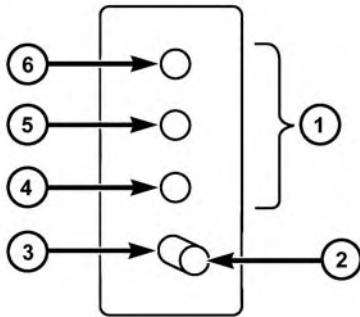

057003766

1 — Female Pins

2 — Male Pin

3 — Ground

4 — Park

5 — Left Stop/Turn

6 — Right Stop/Turn

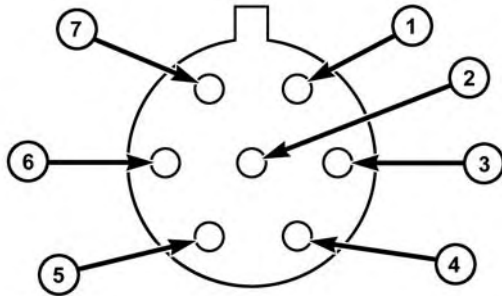

057003765

- |                     |                    |
|---------------------|--------------------|
| 1 — Battery         | 5 — Ground         |
| 2 — Backup Lamps    | 6 — Left Stop/Turn |
| 3 — Right Stop/Turn | 7 — Running Lamps  |
| 4 — Electric Brakes |                    |

### Towing Tips

Before setting out on a trip, practice turning, stopping and backing the trailer in an area away from heavy traffic.

### Manual Transmission — If Equipped

If using a manual transmission vehicle for trailer towing, all starts must be in first gear to avoid excessive clutch slippage.

### Automatic Transmission — If Equipped

The DRIVE range can be selected when towing. However, if frequent shifting occurs while in DRIVE, use the AutoStick® shift control to manually select a lower gear.

**NOTE:** Using a lower gear while operating the vehicle under heavy loading conditions, will improve performance and extend transmission life by reducing excessive shifting and heat buildup. This action will also provide better engine braking.

If you REGULARLY tow a trailer for more than 45 minutes of continuous operation, then change the transmission fluid and filter as specified for severe usage

(police, fleet, taxi, or frequent trailer towing). Refer to the "Maintenance Schedule" for the proper maintenance intervals.

### **AutoStick®**

When using the AutoStick® shift control, select the highest gear that allows for adequate performance and avoids frequent downshifts. For example, choose "4" if the desired speed can be maintained. Choose "3" or "2" if needed to maintain the desired speed.

To prevent excess heat generation, avoid continuous driving at high RPM. Reduce vehicle speed as necessary to avoid extended driving at high RPM. Return to a higher gear or vehicle speed when grade and road conditions allow.

### **Electronic Speed Control — If Equipped**

- Do not use in hilly terrain or with heavy loads.

- When using the speed control, if you experience speed drops greater than 10 mph (16 km/h), disengage until you can get back to cruising speed.
- Use speed control in flat terrain and with light loads to maximize fuel efficiency.

### **Cooling System**

To reduce potential for engine and transmission overheating, take the following actions:

#### **City Driving**

When stopped for short periods, shift the transmission into NEUTRAL and increase engine idle speed.

#### **Highway Driving**

Reduce speed.

#### **Air Conditioning**

Turn off temporarily.

**RECREATIONAL TOWING (BEHIND MOTORHOME, ETC.)****Towing This Vehicle Behind Another Vehicle**

<b>Towing Condition</b>	<b>Wheels OFF the Ground</b>	<b>Manual Transmission</b>	<b>Automatic Transmission</b>
Flat Tow	None	• Transmission in NEUTRAL	<b>NOT ALLOWED</b>
Dolly Tow	Front	<b>NOT ALLOWED</b>	<b>NOT ALLOWED</b>
	Rear	<b>NOT ALLOWED</b>	<b>NOT ALLOWED</b>
On Trailer	<b>All</b>	OK	OK

**NOTE:** When recreationally towing your vehicle, always follow applicable state and provincial laws. Contact state and provincial Highway Safety offices for additional details.

**NOTE:** Vehicles equipped with **manual transmissions** may be recreationally towed (flat towed) at any legal highway speed, for any distance, if the **manual transmission** is in the NEUTRAL position.

**CAUTION!**

- **DO NOT** flat tow any vehicle equipped with an automatic transmission. Damage to the drivetrain will result. If these vehicles require towing, make sure all drive wheels are OFF the ground.
- Do not dolly tow this vehicle. Use of a towing dolly can cause significant damage to your vehicle. Damage from improper towing is not covered under the New Vehicle Limited Warranty.
- Towing this vehicle in violation of the above requirements can cause severe transmission damage. Damage from improper towing is not covered under the New Vehicle Limited Warranty.

# WHAT TO DO IN EMERGENCIES

## CONTENTS

---

- HAZARD WARNING FLASHERS . . . . . 519
- IF YOUR ENGINE OVERHEATS . . . . . 519
- WHEEL AND TIRE TORQUE SPECIFICATIONS . . . . . 520
  - Torque Specifications . . . . . 521
- TIREFIT KIT — IF EQUIPPED . . . . . 523
  - TIREFIT Storage . . . . . 523
  - TIREFIT Kit Components And Operation. . . . . 523
  - TIREFIT Usage Precautions. . . . . 524
- Sealing A Tire With TIREFIT . . . . . 527
- JACKING AND TIRE CHANGING . . . . . 532
  - Jack Location/Spare Tire Stowage . . . . . 533
  - Preparations For Jacking . . . . . 534
  - Jacking And Changing A Tire . . . . . 535
  - Road Tire Installation. . . . . 542
- JUMP-STARTING PROCEDURES . . . . . 544
  - Preparations For Jump-Start . . . . . 545

**518 WHAT TO DO IN EMERGENCIES**

□ Jump-Starting Procedure . . . . .	.546	■ TOWING A DISABLED VEHICLE . . . . .	.552
■ FREEING A STUCK VEHICLE . . . . .	.548	□ Automatic Transmission . . . . .	.553
■ SHIFT LEVER OVERRIDE . . . . .	.550	□ Manual Transmission . . . . .	.553



## HAZARD WARNING FLASHERS

The Hazard Warning flasher switch is located in the center of the instrument panel.



Press the switch to turn on the Hazard Warning flashers. When the switch is activated, all directional turn signals will flash on and off to warn oncoming traffic of an emergency. Press the switch a second time to turn off the Hazard Warning flashers.

This is an emergency warning system and it should not be used when the vehicle is in motion. Use it when your vehicle is disabled and it is creating a safety hazard for other motorists.

When you must leave the vehicle to seek assistance, the Hazard Warning flashers will continue to operate even though the ignition is placed in the OFF position.

**NOTE:** With extended use the Hazard Warning flashers may wear down your battery.

## IF YOUR ENGINE OVERHEATS

In any of the following situations, you can reduce the potential for overheating by taking the appropriate action.

- On the highways — slow down.
- In city traffic — while stopped, place the transmission in NEUTRAL, but do not increase the engine idle speed.

**NOTE:** There are steps that you can take to slow down an impending overheat condition:

- If your air conditioner (A/C) is on, turn it off. The A/C system adds heat to the engine cooling system and turning the A/C off can help remove this heat.

- You can also turn the temperature control to maximum heat, the mode control to floor and the blower control to high. This allows the heater core to act as a supplement to the radiator and aids in removing heat from the engine cooling system.

### CAUTION!

Driving with a hot cooling system could damage your vehicle. If the temperature gauge reads "H," pull over and stop the vehicle. Idle the vehicle with the air conditioner turned off until the pointer drops back into the normal range. If the pointer remains on the "H," turn the engine off immediately and call for service.

### WARNING!

You or others can be badly burned by hot engine coolant (antifreeze) or steam from your radiator. If you see or hear steam coming from under the hood, do not open the hood until the radiator has had time to cool. Never try to open a cooling system pressure cap when the radiator or coolant bottle is hot.

### WHEEL AND TIRE TORQUE SPECIFICATIONS

Proper lug nut/bolt torque is very important to ensure that the wheel is properly mounted to the vehicle. Any time a wheel has been removed and reinstalled on the vehicle the lug nuts/bolts should be torqued using a properly calibrated torque wrench.

## Torque Specifications

Lug Nut/Bolt Torque	**Lug Nut/ Bolt Size	Lug Nut/ Bolt Socket Size
100 Ft-Lbs (135 N·m)	M12 x 1.25	19 mm

\*\*Use only Chrysler recommended lug nuts/bolts and clean or remove any dirt or oil before tightening.

Inspect the wheel mounting surface prior to mounting the tire and remove any corrosion or loose particles.

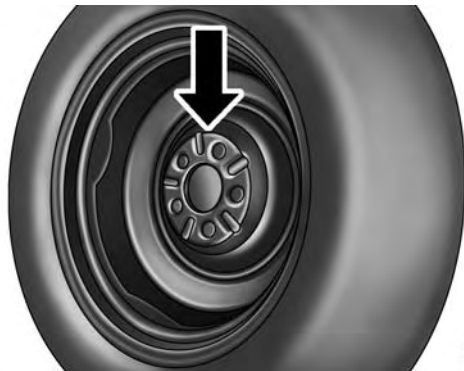

Wheel Mounting Surface

0605005441

Tighten the lug nuts/bolts in a star pattern until each nut/bolt has been tightened twice.



0605006372

Torque Patterns

After 25 miles (40 km) check the lug nut/bolt torque to be sure that all the lug nuts/bolts are properly seated against the wheel.

**WARNING!**

To avoid the risk of forcing the vehicle off the jack, do not tighten the lug nuts fully until the vehicle has been lowered. Failure to follow this warning may result in personal injury.

## TIREFIT KIT — IF EQUIPPED

Small punctures up to ¼" (6 mm) in the tire tread can be sealed with TIREFIT. Foreign objects (e.g., screws or nails) should not be removed from the tire. TIREFIT can be used in outside temperatures down to approximately -4°F (-20°C).

This kit will provide a temporary tire seal, allowing you to drive your vehicle up to 100 miles (160 km) with a maximum speed of 55 mph (90 km/h).

### TIREFIT Storage

The TIREFIT kit is located in the trunk.

## TIREFIT Kit Components And Operation

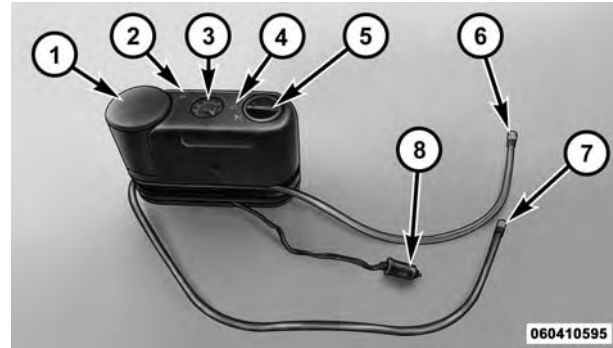

### TIREFIT Components

- |                      |  |
|----------------------|--|
| 1 — Sealant Bottle   | 5 — Mode Select Knob                                   |
| 2 — Deflation Button | 6 — Sealant Hose (Clear)                               |
| 3 — Pressure Gauge   | 7 — Air Pump Hose (Black)                              |
| 4 — Power Button     | 8 — Power Plug (located on bottom side of TIREFIT Kit) |

## Using The Mode Select Knob And Hoses

Your TIREFIT kit is equipped with the following symbols to indicate the air or sealant mode.

### Selecting Air Mode



Push in the Mode Select Knob (5) and turn to this position for air pump operation only. Use the Black Air Pump Hose (7) when selecting this mode.

### Selecting Sealant Mode



Push in the Mode Select Knob (5) and turn to this position to inject the TIREFIT Sealant and to inflate the tire. Use the Sealant Hose (clear hose) (6) when selecting this mode.

## Using The Power Button



Push and release the Power Button (4) once to turn On the TIREFIT kit. Push and release the Power Button (4) again to turn Off the TIREFIT kit.

## Using The Deflation Button



Press the Deflation Button (2) to reduce the air pressure in the tire if it becomes over-inflated.

## TIREFIT Usage Precautions

- Replace the TIREFIT Sealant Bottle (1) and Sealant Hose (6) prior to the expiration date (printed at the lower right hand corner on the bottle label) to assure optimum operation of the system. Refer to “Sealing a Tire with TIREFIT” section (F) “Sealant Bottle and Hose Replacement”.



0604018634

### TIREFIT Expiration Date Location

- The Sealant Bottle (1) and Sealant Hose (6) are a one tire application use and need to be replaced after each use. Always replace these components immediately at your original equipment vehicle dealer.
- When the TIREFIT sealant is in a liquid form, clean water, and a damp cloth will remove the material from the vehicle or tire and wheel components. Once the sealant dries, it can easily be peeled off and properly discarded.
- For optimum performance, make sure the valve stem on the wheel is free of debris before connecting the TIREFIT kit.
- You can use the TIREFIT air pump to inflate bicycle tires. The kit also comes with two needles, located in the Accessory Storage Compartment (on the bottom of the air pump) for inflating sport balls, rafts, or similar inflatable items. However, use only the Air Pump Hose (7) and make sure the Mode Select Knob (5) is in the Air Mode when inflating such items to avoid injecting sealant into them. The TIREFIT Sealant is only intended to seal punctures less than ¼" (6 mm) diameter in the tread of your vehicle.
- Do not lift or carry the TIREFIT kit by the hoses.

**WARNING!**

- Do not attempt to seal a tire on the side of the vehicle closest to traffic. Pull far enough off the road to avoid the danger of being hit when using the TIREFIT kit.
- Do not use TIREFIT or drive the vehicle under the following circumstances:
  - If the puncture in the tire tread is approximately 1/4" (6 mm) or larger.
  - If the tire has any sidewall damage.
  - If the tire has any damage from driving with extremely low tire pressure.
  - If the tire has any damage from driving on a flat tire.
  - If the wheel has any damage.
  - If you are unsure of the condition of the tire or the wheel.

*(Continued)*

**WARNING! (Continued)**

- Keep TIREFIT away from open flames or heat source.
- A loose TIREFIT kit thrown forward in a collision or hard stop could endanger the occupants of the vehicle. Always stow the TIREFIT kit in the place provided. Failure to follow these warnings can result in injuries that are serious or fatal to you, your passengers, and others around you.
- Take care not to allow the contents of TIREFIT to come in contact with hair, eyes, or clothing. TIREFIT is harmful if inhaled, swallowed, or absorbed through the skin. It causes skin, eye, and respiratory irritation. Flush immediately with plenty of water if there is any contact with eyes or skin. Change clothing as soon as possible, if there is any contact with clothing.

*(Continued)*



**WARNING! (Continued)**

- **TIREFIT Sealant solution contains latex. In case of an allergic reaction or rash, consult a physician immediately. Keep TIREFIT out of reach of children. If swallowed, rinse mouth immediately with plenty of water and drink plenty of water. Do not induce vomiting! Consult a physician immediately.**

**Sealing A Tire With TIREFIT****(A) Whenever You Stop To Use TIREFIT:**

1. Pull over to a safe location and turn on the vehicle's Hazard Warning flashers.
2. Verify that the valve stem (on the wheel with the deflated tire) is in a position that is near to the ground. This will allow the TIREFIT Hoses (6) and (7) to reach the valve stem and keep the TIREFIT kit flat on the

ground. This will provide the best positioning of the kit when injecting the sealant into the deflated tire and running the air pump. Move the vehicle as necessary to place the valve stem in this position before proceeding.

3. Place the transmission in PARK (auto transmission) or in Gear (manual transmission) and turn Off the ignition.
4. Set the parking brake.

**(B) Setting Up To Use TIREFIT:**

1. Push in the Mode Select Knob (5) and turn to the Sealant Mode position.
2. Uncoil the Sealant Hose (6) and then remove the cap from the fitting at the end of the hose.
3. Place the TIREFIT kit flat on the ground next to the deflated tire.

4. Remove the cap from the valve stem and then screw the fitting at the end of the Sealant Hose (6) onto the valve stem.
5. Uncoil the Power Plug (8) and insert the plug into the vehicle's 12 Volt power outlet.

**NOTE:** Do not remove foreign objects (e.g., screws or nails) from the tire.

### **(C) Injecting TIREFIT Sealant Into The Deflated Tire:**

- Always start the engine before turning ON the TIREFIT kit.

**NOTE:** Manual transmission vehicles must have the parking brake engaged and the shift lever in NEUTRAL.

- After pressing the Power Button (4), the sealant (white fluid) will flow from the Sealant Bottle (1) through the Sealant Hose (6) and into the tire.

**NOTE:** Sealant may leak out through the puncture in the tire.

### **If the sealant (white fluid) does not flow within 0 – 10 seconds through the Sealant Hose (6):**

1. Press the Power Button (4) to turn Off the TIREFIT kit. Disconnect the Sealant Hose (6) from the valve stem. Make sure the valve stem is free of debris. Reconnect the Sealant Hose (6) to the valve stem. Check that the Mode Select Knob (5) is in the Sealant Mode position and not Air Mode. Press the Power Button (4) to turn On the TIREFIT kit.
2. Connect the Power Plug (8) to a different 12 Volt power outlet in your vehicle or another vehicle, if available. Make sure the engine is running before turning ON the TIREFIT kit.
3. The Sealant Bottle (1) may be empty due to previous use. Call for assistance.

**NOTE:** If the Mode Select Knob (5) is on Air Mode and the pump is operating, air will dispense from the Air Pump Hose (7) only, not the Sealant Hose (6).

**If the sealant (white fluid) does flow through the Sealant Hose (6):**

1. Continue to operate the pump until sealant is no longer flowing through hose (typically takes 30 - 70 seconds). As the sealant flows through the Sealant Hose (6), the Pressure Gauge (3) can read as high as 70 psi (5 Bar). The Pressure Gauge (3) will decrease quickly from approximately 70 psi (5 Bar) to the actual tire pressure when the Sealant Bottle (1) is empty.
2. The pump will start to inject air into the tire immediately after the Sealant Bottle (1) is empty. Continue to operate the pump and inflate the tire to the pressure indicated on the tire pressure label on the driver-side latch pillar (recommended pressure). Check the tire pressure by looking at the Pressure Gauge (3).

**If the tire does not inflate to at least 26 psi (1.8 Bar) pressure within 15 minutes:**

- The tire is too badly damaged. Do not attempt to drive the vehicle further. Call for assistance.

**NOTE:** If the tire becomes over-inflated, press the Deflation Button to reduce the tire pressure to the recommended inflation pressure before continuing.

**If the tire inflates to the recommended pressure or is at least 26 psi (1.8 Bar) pressure within 15 minutes:**

1. Press the Power Button (4) to turn off the TIREFIT kit.
2. Remove the Speed Limit sticker from the top of the Sealant Bottle (1) and place the sticker on the instrument panel.
3. Immediately disconnect the Sealant Hose (6) from the valve stem, reinstall the cap on the fitting at the end of the hose, and place the TIREFIT kit in the vehicle

storage location. Quickly proceed to (D) "Drive Vehicle."

### CAUTION!

- The metal end fitting from Power Plug (8) may get hot after use, so it should be handled carefully.
- Failure to reinstall the cap on the fitting at the end of the Sealant Hose (6) can result in sealant contacting your skin, clothing, and the vehicle's interior. It can also result in sealant contacting internal TIREFIT kit components which may cause permanent damage to the kit.

#### (D) Drive Vehicle:

Immediately after injecting sealant and inflating the tire, drive the vehicle 5 miles (8 km) or 10 minutes to ensure distribution of the TIREFIT Sealant within the tire. Do not exceed 55 mph (90 km/h).

### WARNING!

TIREFIT is not a permanent flat tire repair. Have the tire inspected and repaired or replaced after using TIREFIT. Do not exceed 55 mph (90 km/h) until the tire is repaired or replaced. Failure to follow this warning can result in injuries that are serious or fatal to you, your passengers, and others around you.

#### (E) After Driving:

Pull over to a safe location. Refer to "Whenever You Stop to Use TIREFIT" before continuing.

1. Push in the Mode Select Knob (5) and turn to the Air Mode position.
2. Uncoil the power plug and insert the plug into the vehicle's 12 Volt power outlet.

3. Uncoil the Air Pump Hose (7) (black in color) and screw the fitting at the end of hose (7) onto the valve stem.
4. Check the pressure in the tire by reading the Pressure Gauge (3).
2. Disconnect the TIREFIT kit from the valve stem, reinstall the cap on the valve stem and unplug from 12 Volt outlet.
3. Place the TIREFIT kit in its proper storage area in the vehicle.

**If tire pressure is less than 19 psi (1.3 Bar):**

The tire is too badly damaged. Do not attempt to drive the vehicle further. Call for assistance.

**If the tire pressure is 19 psi (1.3 Bar) or higher:**

1. Press the Power Button (4) to turn on TIREFIT and inflate the tire to the pressure indicated on the tire and loading information label on the driver-side door opening.
4. Have the tire inspected and repaired or replaced at the earliest opportunity at an authorized dealer or tire service center.
5. Replace the Sealant Bottle (1) and Sealant Hose (6) assembly at your authorized dealer as soon as possible. Refer to (F) "Sealant Bottle and Hose Replacement".

**NOTE:** If the tire becomes over-inflated, press the Deflation Button to reduce the tire pressure to the recommended inflation pressure before continuing.

**NOTE:** When having the tire serviced, advise the authorized dealer or service center that the tire has been sealed using the TIREFIT service kit.

**(F) Sealant Bottle And Hose Replacement:**

1. Uncoil the Sealant Hose (6) (clear in color).
2. Locate the round Sealant Bottle release button in the recessed area under the sealant bottle.
3. Press the Sealant Bottle release button. The Sealant Bottle (1) will pop up. Remove the bottle and dispose of it accordingly.
4. Clean any remaining sealant from the TIREFIT housing.
5. Position the new Sealant Bottle (1) in the housing so that the Sealant Hose (6) aligns with the hose slot in the front of the housing. Press the bottle into the housing. An audible click will be heard indicating the bottle is locked into place.
6. Verify that the cap is installed on the fitting at the end of the Sealant Hose (6) and return the hose to its storage area (located on the bottom of the air pump).

7. Return the TIREFIT kit to its storage location in the vehicle.

**JACKING AND TIRE CHANGING****WARNING!**

- Do not attempt to change a tire on the side of the vehicle close to moving traffic. Pull far enough off the road to avoid the danger of being hit when operating the jack or changing the wheel.
- Being under a jacked-up vehicle is dangerous. The vehicle could slip off the jack and fall on you. You could be crushed. Never put any part of your body under a vehicle that is on a jack. If you need to get under a raised vehicle, take it to a service center where it can be raised on a lift.

*(Continued)*

**WARNING! (Continued)**

- Never start or run the engine while the vehicle is on a jack.
- The jack is designed to be used as a tool for changing tires only. The jack should not be used to lift the vehicle for service purposes. The vehicle should be jacked on a firm level surface only. Avoid ice or slippery areas.

**Jack Location/Spare Tire Stowage**

The jack and spare tire are both stowed under an access cover in the trunk. Follow these steps to access the jack and spare tire.

1. Open the trunk.
2. Lift the access cover using the pull strap.

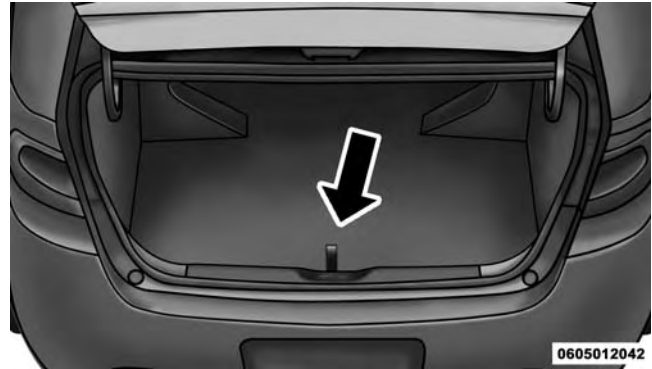

Pull Strap

3. Remove the fastener securing the jack and spare tire.

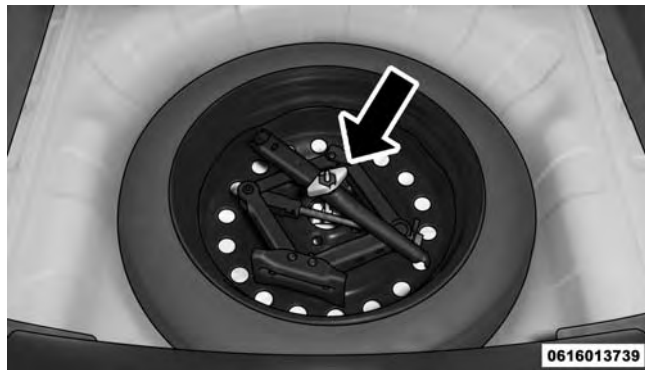

**Jack Location**

4. Remove the scissors jack and wheel bolt wrench from the spare wheel as an assembly. Turn the jack screw to the left to loosen the wheel bolt wrench, and remove the wrench from the jack assembly.

5. Remove the spare tire.

### **WARNING!**

A loose tire or jack thrown forward in a collision or hard stop could endanger the occupants of the vehicle. Always stow the jack parts and the spare tire in the places provided. Have the deflated (flat) tire repaired or replaced immediately.

### **Preparations For Jacking**

1. Park the vehicle on a firm, level surface as far from the edge of the roadway as possible. Avoid icy or slippery areas.



**WARNING!**

Do not attempt to change a tire on the side of the vehicle close to moving traffic, pull far enough off the road to avoid being hit when operating the jack or changing the wheel.

2. Turn on the Hazard Warning flasher.
3. Set the parking brake.
4. Place the shift lever into PARK.
5. Turn OFF the ignition.
6. Block the front and rear of the wheel diagonally opposite of the jacking position. For example, if changing the right front tire, block the left rear wheel.



060505162

**NOTE:** Passengers should not remain in the vehicle when the vehicle is being jacked.

**Jacking And Changing A Tire****WARNING!**

Carefully follow these tire changing warnings to help prevent personal injury or damage to your vehicle:

- Always park on a firm, level surface as far from the edge of the roadway as possible before raising the vehicle.
- Turn on the Hazard Warning flasher.
- Block the wheel diagonally opposite the wheel to be raised.
- Set the parking brake firmly and set an automatic transmission in PARK; a manual transmission in REVERSE.

*(Continued)*

**WARNING!** *(Continued)*

- Never start or run the engine with the vehicle on a jack.
- Do not let anyone sit in the vehicle when it is on a jack.
- Do not get under the vehicle when it is on a jack. If you need to get under a raised vehicle, take it to a service center where it can be raised on a lift.
- Only use the jack in the positions indicated and for lifting this vehicle during a tire change.
- If working on or near a roadway, be extremely careful of motor traffic.



Jack Warning Label

**CAUTION!**

Do not attempt to raise the vehicle by jacking on locations other than those indicated in the Jacking Instructions for this vehicle.

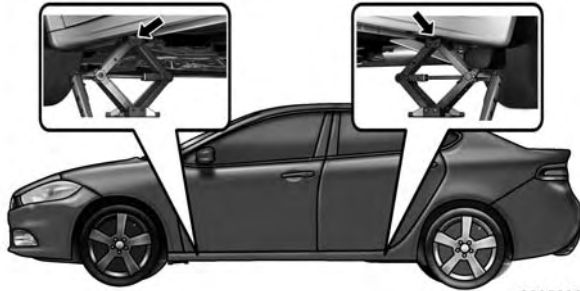

0605020333

### Jacking Locations

1. Remove the spare tire, jack, and wheel bolt wrench.

**NOTE:** The jack handle attaches to the side of the jack with two attachment points. When the jack is partially expanded, the tension between the two attachment points holds the jack handle in place.

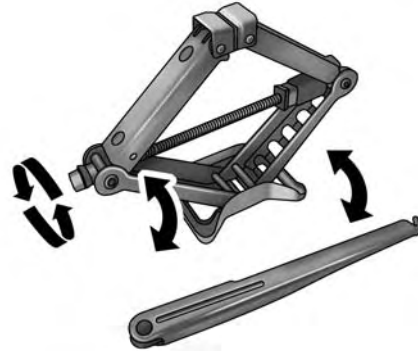

0616013740

### Removing Jack Handle From Jack

2. If equipped with aluminum wheels where the center cap covers the wheel bolts, use the wheel bolt wrench to pry the center cap off carefully before raising the vehicle.

3. Before raising the vehicle, use the wheel bolt wrench to loosen, but not remove, the wheel bolts on the wheel with the flat tire. Turn the wheel bolts counter-clockwise one turn while the wheel is still on the ground.
4. Place the jack underneath the notched lift area that is closest to the flat tire. Turn the jack screw clockwise to firmly engage the jack saddle with the lift area of the sill flange, centering the jack saddle between the locating notches on the sill flange.

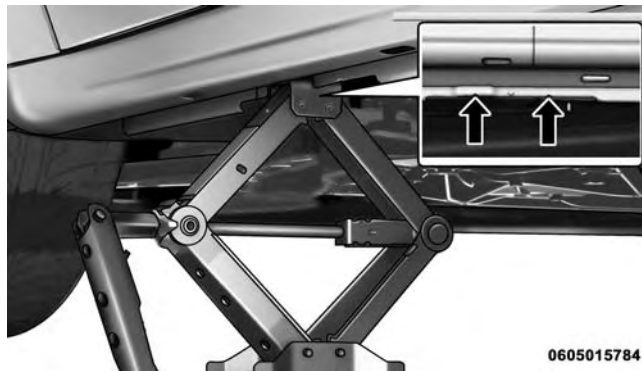

0605015784

Front Jacking Location



Rear Jacking Location

5. Raise the vehicle just enough to remove the flat tire and install the spare tire.

### WARNING!

Raising the vehicle higher than necessary can make the vehicle less stable. It could slip off the jack and hurt someone near it. Raise the vehicle only enough to remove the tire.

6. Remove the wheel bolts and tire.
7. Mount the spare tire.

**CAUTION!**

Be sure to mount the spare tire with the valve stem facing outward. The vehicle could be damaged if the spare tire is mounted incorrectly.

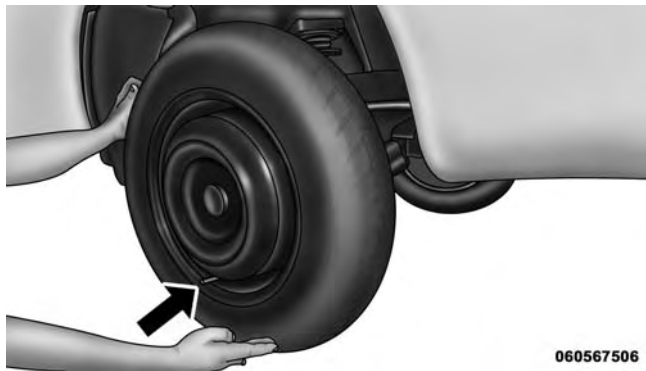

060567506

Mounting Spare Tire

**NOTE:**

- For vehicles so equipped, do not attempt to install a center cap or wheel cover on the compact spare.
  - Refer to “Compact Spare Tire” and to “Limited-Use Spare” under “Tires — General Information” in “Starting and Operating” for additional warnings, cautions, and information about the spare tire, its use, and operation.
8. Install the wheel bolts with the threaded end of the wheel bolt toward the wheel. Lightly tighten the wheel bolts.

**WARNING!**

To avoid the risk of forcing the vehicle off the jack, do not fully tighten the wheel bolts until the vehicle has been lowered. Failure to follow this warning may result in personal injury.

9. Lower the vehicle to the ground by turning the jack handle counterclockwise.
10. Finish tightening the wheel bolts. Push down on the wrench while at the end of the handle for increased leverage. Tighten the wheel bolts in a star pattern until each wheel bolt has been tightened twice. Refer to "Torque Specifications" in this section for proper lug bolt torque. If in doubt about the correct tightness, have them checked with a torque wrench by your authorized dealer or at a service station.
11. Lower the jack until it is free. Remove the wheel blocks. Reassemble the lug wrench to the jack assembly and stow it in the spare tire area. Secure the assembly using the means provided. Release the parking brake before driving the vehicle.
12. Stow the jack, tools and flat tire.

**WARNING!**

**A loose tire or jack thrown forward in a collision or hard stop could endanger the occupants of the vehicle. Always stow the jack parts and the spare tire in the places provided. Have the deflated (flat) tire repaired or replaced immediately.**

## Road Tire Installation

### Vehicles Equipped With Wheel Covers

1. Mount the road tire on the axle.
2. To ease the installation process for steel wheels with wheel covers, install two wheel bolts on the wheel which are on each side of the valve stem. Install the wheel bolts with the threaded end of the bolt toward the wheel. Lightly tighten the wheel bolts.

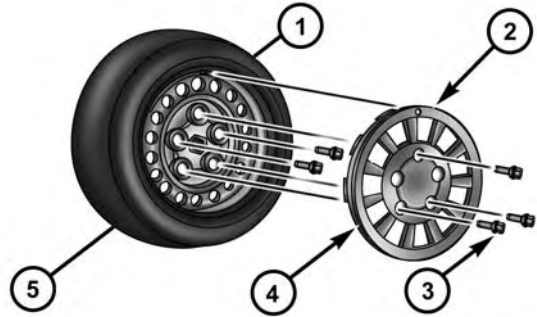

060567721

### Tire And Wheel Cover Or Center Cap

- |                 |                 |
|-----------------|-----------------|
| 1 — Valve Stem  | 4 — Wheel Cover |
| 2 — Valve Notch | 5 — Road Wheel  |
| 3 — Wheel bolt  |                 |

3. Align the valve notch in the wheel cover with the valve stem on the wheel. Install the cover by hand,



snapping the cover over the two wheel bolts. Do not use a hammer or excessive force to install the cover.

4. Install the remaining wheel bolts with the threaded end of the wheel bolt toward the wheel. Lightly tighten the wheel bolts.

### WARNING!

**To avoid the risk of forcing the vehicle off the jack, do not tighten the lug nuts fully until the vehicle has been lowered. Failure to follow this warning may result in personal injury.**

5. Lower the vehicle to the ground by turning the jack handle counterclockwise.
6. Finish tightening the wheel bolts. Push down on the wrench while at the end of the handle for increased leverage. Tighten the wheel bolts in a star pattern until each wheel bolt has been tightened twice. Refer to

“Torque Specifications” in this section for proper lug bolt torque. If in doubt about the correct tightness, have them checked with a torque wrench by your authorized dealer or service station.

7. Lower the jack until it is free. Remove the wheel blocks. Reassemble the lug wrench to the jack assembly and stow it in the spare tire area. Secure the assembly using the means provided. Release the parking brake before driving the vehicle.
8. After 25 miles (40 km) check the wheel bolt torque with a torque wrench to ensure that all wheel bolts are properly seated against the wheel.

### Road Tire Installation

1. Mount the road tire on the axle.

2. Install the remaining wheel bolts with the threaded end of the wheel bolt toward the wheel. Lightly tighten the wheel bolts.

**WARNING!**

**To avoid the risk of forcing the vehicle off the jack, do not tighten the lug nuts fully until the vehicle has been lowered. Failure to follow this warning may result in personal injury.**

3. Lower the vehicle to the ground by turning the jack handle counterclockwise.
4. Finish tightening the wheel bolts. Push down on the wrench while at the end of the handle for increased leverage. Tighten the wheel bolts in a star pattern until each wheel bolt has been tightened twice. Refer to "Torque Specifications" in this section for the proper

lug bolt torque. If in doubt about the correct tightness, have them checked with a torque wrench by your authorized dealer or service station.

5. Lower the jack until it is free. Remove the wheel blocks. Reassemble the lug wrench to the jack assembly and stow it in the spare tire area. Secure the assembly using the means provided. Release the parking brake before driving the vehicle.
6. After 25 miles (40 km) check the wheel bolt torque with a torque wrench to ensure that all wheel bolts are properly seated against the wheel.

**JUMP-STARTING PROCEDURES**

If your vehicle has a discharged battery it can be jump-started using a set of jumper cables and a battery in another vehicle or by using a portable battery booster pack. Jump-starting can be dangerous if done improperly so please follow the procedures in this section carefully.

**NOTE:** When using a portable battery booster pack follow the manufacturer's operating instructions and precautions.

### CAUTION!

Do not use a portable battery booster pack or any other booster source with a system voltage greater than 12 Volts or damage to the battery, starter motor, alternator or electrical system may occur.

### WARNING!

Do not attempt jump-starting if the battery is frozen. It could rupture or explode and cause personal injury.

### Preparations For Jump-Start

The battery in your vehicle is located in the front of the engine compartment, behind the left headlight assembly.

**NOTE:** The positive battery post is covered with a protective cap. Lift up on the cap to gain access to the positive battery post.

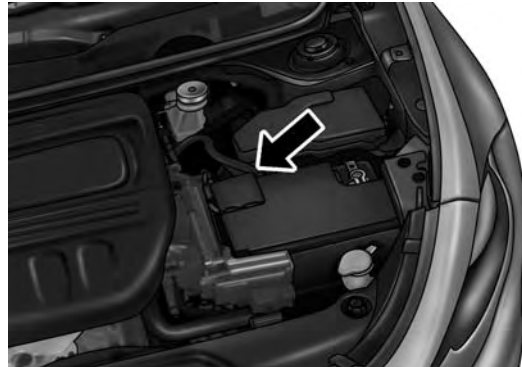

Positive Battery Post

060864281

**WARNING!**

- Take care to avoid the radiator cooling fan whenever the hood is raised. It can start anytime the ignition switch is ON. You can be injured by moving fan blades.
- Remove any metal jewelry such as rings, watch bands and bracelets that could make an inadvertent electrical contact. You could be seriously injured.
- Batteries contain sulfuric acid that can burn your skin or eyes and generate hydrogen gas which is flammable and explosive. Keep open flames or sparks away from the battery.

1. Set the parking brake, shift the automatic transmission into PARK (manual transmission in NEUTRAL) and turn the ignition to LOCK.
2. Turn off the heater, radio, and all unnecessary electrical accessories.

3. If using another vehicle to jump-start the battery, park the vehicle within the jumper cables reach, set the parking brake and make sure the ignition is OFF.

**WARNING!**

Do not allow vehicles to touch each other as this could establish a ground connection and personal injury could result.

**Jump-Starting Procedure****WARNING!**

Failure to follow this jump-starting procedure could result in personal injury or property damage due to battery explosion.

**CAUTION!**

Failure to follow these procedures could result in damage to the charging system of the booster vehicle or the discharged vehicle.

**Connecting The Jumper Cables**

1. Connect the positive (+) end of the jumper cable to the positive (+) post of the discharged vehicle.
2. Connect the opposite end of the positive (+) jumper cable to the positive (+) post of the booster battery.
3. Connect the negative end (-) of the jumper cable to the negative (-) post of the booster battery.
4. Connect the opposite end of the negative (-) jumper cable to a good engine ground (exposed metal part of the discharged vehicle's engine) away from the battery and the fuel injection system.

**WARNING!**

Do not connect the jumper cable to the negative (-) post of the discharged battery. The resulting electrical spark could cause the battery to explode and could result in personal injury. Only use the specific ground point, do not use any other exposed metal parts.

5. Start the engine in the vehicle that has the booster battery, let the engine idle a few minutes, and then start the engine in the vehicle with the discharged battery.

6. Once the engine is started, remove the jumper cables in the reverse sequence:

### Disconnecting The Jumper Cables

1. Disconnect the negative (-) jumper cable from the engine ground of the vehicle with the discharged battery.
2. Disconnect the negative end (-) of the jumper cable from the negative (-) post of the booster battery.
3. Disconnect the opposite end of the positive (+) jumper cable from the positive (+) post of the booster battery.
4. Disconnect the positive (+) end of the jumper cable from the positive (+) post of the discharged vehicle.

If frequent jump-starting is required to start your vehicle you should have the battery and charging system inspected at your authorized dealer.

### CAUTION!

Accessories plugged into the vehicle power outlets draw power from the vehicle's battery, even when not in use (i.e., cellular phones, etc.). Eventually, if plugged in long enough without engine operation, the vehicle's battery will discharge sufficiently to degrade battery life and/or prevent the engine from starting.

### FREEMING A STUCK VEHICLE

If your vehicle becomes stuck in mud, sand, or snow, it can often be moved by a rocking motion. Turn your steering wheel right and left to clear the area around the front wheels. Then shift back and forth between DRIVE and REVERSE (with automatic transmission) or 2nd Gear and REVERSE (with manual transmission) while gently

pressing the accelerator. Use the least amount of accelerator pedal pressure that will maintain the rocking motion, without spinning the wheels or racing the engine.

**NOTE:** 1.4L Turbo automatic transmission vehicles cannot be rocked in this manner, because the transmission will not allow shifts between DRIVE and REVERSE while the wheels are turning.

### CAUTION!

Racing the engine or spinning the wheels may lead to transmission overheating and failure. Allow the engine to idle with the transmission in NEUTRAL for at least one minute after every five rocking-motion cycles. This will minimize overheating and reduce the risk of clutch or transmission failure during prolonged efforts to free a stuck vehicle.

**NOTE:** Press the ESC off switch, to place the Electronic Stability Control (ESC) system in “partial off” mode, before rocking the vehicle. Refer to “Electronic Brake Control” in “Starting And Operating” for further information. Once the vehicle has been freed, press the ESC off switch again to restore ESC on mode.

### CAUTION!

- When “rocking” a stuck vehicle by shifting between DRIVE/2nd gear and REVERSE, do not spin the wheels faster than 15 mph (24 km/h), or drivetrain damage may result.
- Revving the engine or spinning the wheels too fast may lead to transmission overheating and failure. It can also damage the tires. Do not spin the wheels above 30 mph (48 km/h) while in gear (no transmission shifting occurring).

**WARNING!**

Fast spinning tires can be dangerous. Forces generated by excessive wheel speeds may cause damage, or even failure, of the axle and tires. A tire could explode and injure someone. Do not spin your vehicle's wheels faster than 30 mph (48 km/h) or for longer than 30 seconds continuously without stopping when you are stuck and do not let anyone near a spinning wheel, no matter what the speed.

**SHIFT LEVER OVERRIDE**

If a malfunction occurs and the shift lever cannot be moved out of the PARK position, you can use the following procedure to temporarily move the shift lever:

1. Turn the engine OFF.
2. Firmly apply the parking brake.

3. Remove the rubber storage tray liner from the center console, then lift up the front of the shift lever bezel, carefully disengage the bezel from the shift lever housing, and slide it up to the top of the shift lever.

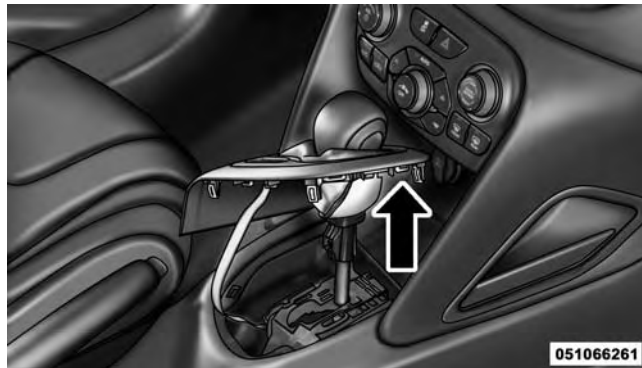
**Shift Lever Bezel**

4. Press and maintain firm pressure on the brake pedal.



5. Insert a small screwdriver or similar tool down into the access slot at the front of the shift lever assembly, and push and hold the white override release lever down.



**Override Release Tab**

6. Move the shift lever to the NEUTRAL position.



**Shift Lever**

7. The vehicle may then be started in NEUTRAL.
8. Reinstall the shift lever bezel (use care to avoid pinching the wiring), and the rubber storage tray liner.

**TOWING A DISABLED VEHICLE**

**NOTE:** This section describes procedures for towing a disabled vehicle using a commercial wrecker service.

<b>Towing Condition</b>	<b>WheelsOFF The Ground</b>	<b>AUTOMATIC TRANSMISSION</b>	<b>MANUAL TRANSMISSION</b>
Flat Tow	NONE	NOT ALLOWED	Trans in NEUTRAL
Dolly Tow	Rear	NOT ALLOWED	NOT ALLOWED
	Front	NOT ALLOWED	NOT ALLOWED
Flatbed	ALL	OK	OK

Proper towing or lifting equipment is required to prevent damage to your vehicle. Use only tow bars and other equipment designed for this purpose, following equipment manufacturer's instructions. Use of safety chains is mandatory. Attach a tow bar or other towing device to main structural members of the vehicle, not to bumpers or associated brackets. State and local laws regarding vehicles under tow must be observed.

**CAUTION!**

**DO NOT use sling-type equipment when towing. When securing the vehicle to a flatbed truck, do not attach to front or rear suspension components. Damage to your vehicle may result from improper towing.**

If you must use the accessories (wipers, defroster, etc.) while being towed, the key must be in the ON/RUN position, not the ACC position.

## Automatic Transmission

Automatic transmission vehicles must be towed with all four wheels OFF the ground using a flatbed.

### CAUTION!

- **DO NOT** flat tow any vehicle equipped with an automatic transmission. Damage to the drivetrain will result.
- Do not dolly tow this vehicle. Use of a towing dolly can cause significant damage to your vehicle. Damage from improper towing is not covered under the New Vehicle Limited Warranty.
- Towing this vehicle in violation of the above requirements can cause severe transmission damage. Damage from improper towing is not covered under the New Vehicle Limited Warranty.

If the key fob is unavailable, or the vehicle's battery is discharged, refer to "Shift Lever Override" in this section

for instructions on shifting the automatic transmission out of PARK for loading onto a flatbed truck.

## Manual Transmission

- The manufacturer recommends towing your vehicle with all four wheels **OFF** the ground using a flatbed.
- Manual transmission vehicles can also be flat towed (all four wheels on the ground) with the transmission in NEUTRAL.

### CAUTION!

- **DO NOT** flat tow any disabled vehicle if condition is related to a clutch, transmission or driveline component. Damage to the drivetrain could result.
- Towing this vehicle in violation of the above requirements can cause severe transmission damage. Damage from improper towing is not covered under the New Vehicle Limited Warranty.



# MAINTAINING YOUR VEHICLE

## CONTENTS

---

■ ENGINE COMPARTMENT — 1.4L TURBO . . . . .	.557	■ MAINTENANCE PROCEDURES . . . . .	.563
■ ENGINE COMPARTMENT — 2.0L . . . . .	.558	□ Engine Oil . . . . .	.564
■ ENGINE COMPARTMENT — 2.4L . . . . .	.559	□ Engine Oil Filter . . . . .	.567
■ ONBOARD DIAGNOSTIC SYSTEM — OBD II . . . . .	.560	□ Engine Air Cleaner Filter . . . . .	.567
□ Loose Fuel Filler Cap Message . . . . .	.560	□ Tires . . . . .	.568
■ EMISSIONS INSPECTION AND MAINTENANCE PROGRAMS . . . . .	.561	□ Maintenance-Free Battery . . . . .	.568
■ REPLACEMENT PARTS . . . . .	.562	□ Air Conditioner Maintenance . . . . .	.569
■ DEALER SERVICE . . . . .	.563	□ A/C Air Filter . . . . .	.571
		□ Body Lubrication . . . . .	.573
		□ Windshield Wiper Blades . . . . .	.573

□ Adding Washer Fluid . . . . .	.574	■ VEHICLE STORAGE . . . . .	.601
□ Exhaust System . . . . .	.575	■ REPLACEMENT BULBS . . . . .	.602
□ Cooling System . . . . .	.577	■ BULB REPLACEMENT . . . . .	.603
□ Brake System . . . . .	.583	□ Headlamps . . . . .	.603
□ Automatic Transmission — If Equipped . . . . .	.586	□ Backup Lamps. . . . .	.604
□ Manual Transmission — If Equipped . . . . .	.588	□ License Lamp . . . . .	.606
□ Appearance Care And Protection From Corrosion . . . . .	.588	■ FLUID CAPACITIES . . . . .	.607
■ FUSES . . . . .	.595	■ FLUIDS, LUBRICANTS AND GENUINE PARTS . . . . .	.608
□ Interior Fuses . . . . .	.595	□ Engine . . . . .	.608
□ Underhood Fuses. . . . .	.597	□ Chassis . . . . .	.610
□ Body Control Module (BCM) Fuses . . . . .	.600		

## ENGINE COMPARTMENT — 1.4L TURBO

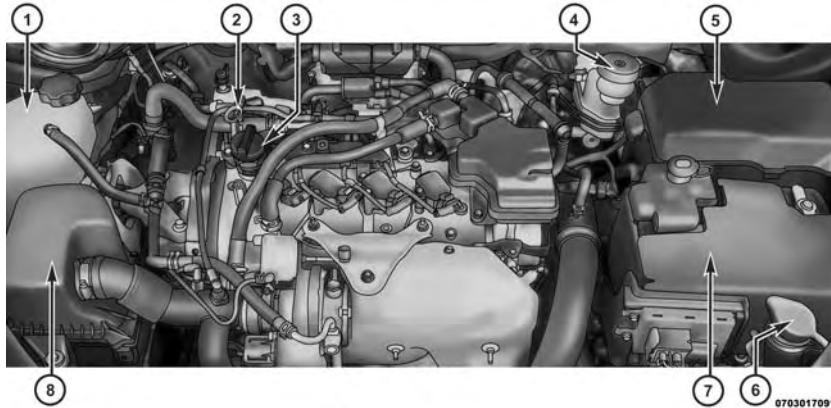

- 1 — Engine Coolant Reservoir
- 2 — Engine Oil Level Indicator
- 3 — Engine Oil Fill
- 4 — Brake Fluid Reservoir

- 5 — Power Distribution Center (Fuses)
- 6 — Washer Fluid Reservoir
- 7 — Battery
- 8 — Air Cleaner Filter

## ENGINE COMPARTMENT — 2.0L

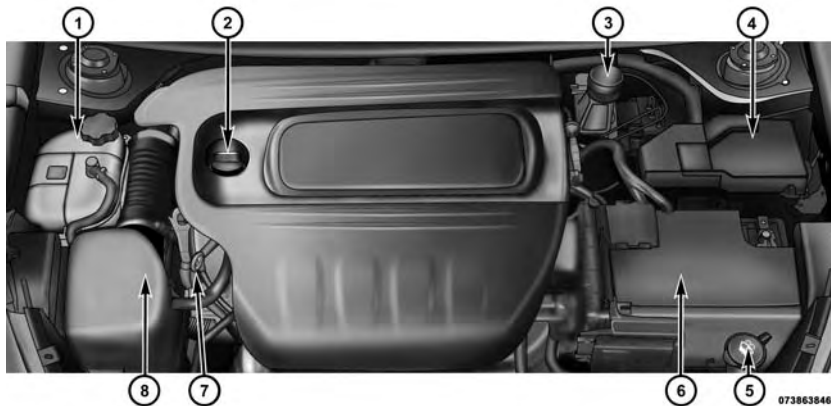

1 — Engine Coolant Reservoir

2 — Engine Oil Fill

3 — Brake Fluid Reservoir

4 — Power Distribution Center (Fuses)

5 — Washer Fluid Reservoir

6 — Battery

7 — Engine Oil Level Indicator

8 — Air Cleaner Filter



## ENGINE COMPARTMENT — 2.4L

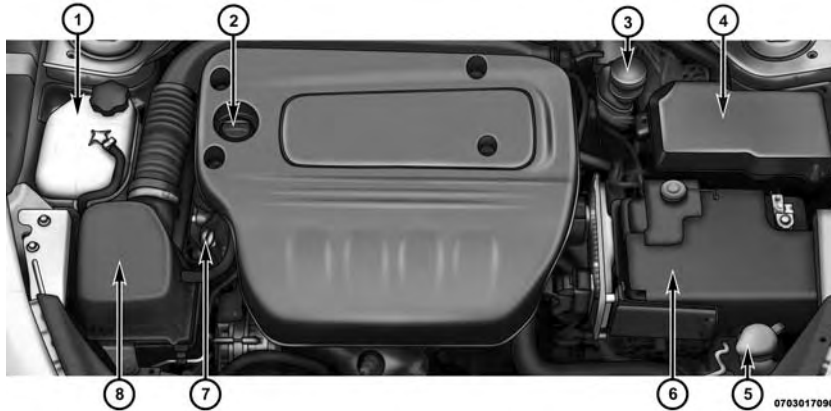

1 — Engine Coolant Reservoir

2 — Engine Oil Fill

3 — Brake Fluid Reservoir

4 — Power Distribution Center (Fuses)

5 — Washer Fluid Reservoir

6 — Battery

7 — Engine Oil Level Indicator

8 — Air Cleaner Filter

## ONBOARD DIAGNOSTIC SYSTEM — OBD II

Your vehicle is equipped with a sophisticated onboard diagnostic system called OBD II. This system monitors the performance of the emissions, engine, and automatic transmission control systems. When these systems are operating properly, your vehicle will provide excellent performance and fuel economy, as well as engine emissions well within current government regulations.

If any of these systems require service, the OBD II system will turn on the “Malfunction Indicator Light” (MIL). It will also store diagnostic codes and other information to assist your service technician in making repairs. Although your vehicle will usually be drivable and not need towing, see your authorized dealer for service as soon as possible.

### CAUTION!

- **Prolonged driving with the MIL on could cause further damage to the emission control system. It could also affect fuel economy and driveability. The vehicle must be serviced before any emissions tests can be performed.**
- **If the MIL is flashing while the engine is running, severe catalytic converter damage and power loss will soon occur. Immediate service is required.**

### Loose Fuel Filler Cap Message

After fuel is added, the vehicle diagnostic system can determine if the fuel filler cap is possibly loose or improperly installed. A “gASCAP” message will be displayed in the instrument cluster. Tighten the gas cap until a “clicking” sound is heard. This is an indication that the gas cap is properly tightened. Press the trip odometer RESET button to turn off the message. If the problem

persists, the message will appear the next time the vehicle is started. This might indicate a damaged cap. If the problem is detected twice in a row, the system will turn on the MIL. Resolving the problem will turn the MIL light off.

## EMISSIONS INSPECTION AND MAINTENANCE PROGRAMS

In some localities, it may be a legal requirement to pass an inspection of your vehicle's emissions control system. Failure to pass could prevent vehicle registration.



For states that require an Inspection and Maintenance (I/M), this check verifies the "Malfunction Indicator Light (MIL)" is functioning and is not on when the engine is running, and that the OBD II system is ready for testing.

Normally, the OBD II system will be ready. The OBD II system may **not** be ready if your vehicle was recently serviced, recently had a dead battery or a battery replacement. If the OBD II system should be determined not ready for the I/M test, your vehicle may fail the test.

Your vehicle has a simple ignition key-actuated test, which you can use prior to going to the test station. To check if your vehicle's OBD II system is ready, you must do the following:

1. Cycle the ignition switch to the ON position, but do not crank or start the engine.

**NOTE:** If you crank or start the engine, you will have to start this test over.

2. As soon as you cycle the ignition switch to the ON position, you will see the MIL symbol come on as part of a normal bulb check.

3. Approximately 15 seconds later, one of two things will happen:

- The MIL will flash for about 10 seconds and then return to being fully illuminated until you turn OFF the ignition or start the engine. This means that your vehicle's OBD II system is **not ready** and you should **not** proceed to the I/M station.
- The MIL will not flash at all and will remain fully illuminated until you turn OFF the ignition or start the engine. This means that your vehicle's OBD II system is **ready** and you can proceed to the I/M station.

If your OBD II system is **not ready**, you should see your authorized dealer or repair facility. If your vehicle was recently serviced or had a battery failure or replacement, you may need to do nothing more than drive your vehicle as you normally would in order for your OBD II system to update. A recheck with the above test routine may then indicate that the system is now ready.

Regardless of whether your vehicle's OBD II system is ready or not, if the MIL is illuminated during normal vehicle operation you should have your vehicle serviced before going to the I/M station. The I/M station can fail your vehicle because the MIL is on with the engine running.

## REPLACEMENT PARTS

Use of genuine MOPAR® parts for normal/scheduled maintenance and repairs is highly recommended to ensure the designed performance. Damage or failures caused by the use of non-MOPAR® parts for maintenance and repairs will not be covered by the New Vehicle Limited Warranty.

## DEALER SERVICE

Your authorized dealer has the qualified service personnel, special tools, and equipment to perform all service operations in an expert manner. Service Manuals are available which include detailed service information for your vehicle. Refer to these Service Manuals before attempting any procedure yourself.

**NOTE:** Intentional tampering with emissions control systems may void your warranty and could result in civil penalties being assessed against you.

### WARNING!

**You can be badly injured working on or around a motor vehicle. Only do service work for which you have the knowledge and the proper equipment. If you have any doubt about your ability to perform a service job, take your vehicle to a competent mechanic.**

## MAINTENANCE PROCEDURES

The pages that follow contain the **required** maintenance services determined by the engineers who designed your vehicle.

Besides those maintenance items specified in the fixed "Maintenance Schedule", there are other components which may require servicing or replacement in the future.

**CAUTION!**

- Failure to properly maintain your vehicle or perform repairs and service when necessary could result in more costly repairs, damage to other components or negatively impact vehicle performance. Immediately have potential malfunctions examined by an authorized dealer or qualified repair center.
- Your vehicle has been built with improved fluids that protect the performance and durability of your vehicle and also allow extended maintenance intervals. Do not use chemical flushes in these components as the chemicals can damage your engine, transmission, power steering or air conditioning. Such damage is not covered by the New Vehicle Limited Warranty. If a flush is needed because of component malfunction, use only the specified fluid for the flushing procedure.

**Engine Oil****Checking Oil Level**

To assure proper engine lubrication, the engine oil must be maintained at the correct level. Check the oil level at regular intervals, such as every fuel stop. The best time to check the engine oil level is about five minutes after a fully warmed engine is shut off. Do not check oil level before starting the engine after it has sat overnight. Checking engine oil level when the engine is cold will give you an incorrect reading.

Checking the oil while the vehicle is on level ground and only when the engine is hot, will improve the accuracy of the oil level readings. Maintain the oil level between the range markings on the dipstick. The range markings will consist of a crosshatch zone which depicts the MIN at the low end of the range and MAX at the high end of the range. Adding 1 qt (1L) of oil when the reading is at the

low end of the indicated range will result in the oil level at the full end of the indicator range.

### CAUTION!

**Do not overfill the engine. Overfilling the engine will cause oil aeration, which can lead to loss of oil pressure and an increase in oil temperature. This could damage your engine. Also, be sure the oil fill cap is replaced and tightened after adding oil.**

### Change Engine Oil

The oil change indicator system will remind you that it is time to take your vehicle in for scheduled maintenance. Refer to the “Maintenance Schedule” for further information.

**NOTE:** Under no circumstances should oil change intervals exceed 10,000 miles (16,000 km) or twelve months, whichever occurs first.

### Engine Oil Selection — 1.4L Turbo Engine

For best performance and maximum protection for all engines under all types of operating conditions, the manufacturer recommends engine oils that are API Certified Grade SN or better and meet the requirements of Chrysler Material Standard MS-12991.

### Engine Oil Selection — 2.0L And 2.4L Engine

For best performance and maximum protection for all engines under all types of operating conditions, the manufacturer recommends engine oils that are API Certified Grade SN or better and meet the requirements of Chrysler Material Standard MS-6395.

### **Engine Oil Viscosity (SAE Grade) — 1.4L Turbo Engine**

MOPAR® SAE 5W-40 synthetic engine oil or equivalent Pennzoil® or Shell Helix® is recommended for all operating temperatures. This engine oil improves low temperature starting and vehicle fuel economy. Your engine oil filler cap also states the recommended engine oil viscosity grade for your engine.

Lubricants which do not have both the engine oil certification mark and the correct SAE viscosity grade number should not be used.

### **Engine Oil Viscosity (SAE Grade) — 2.0L And 2.4L Engine**

MOPAR® SAE 0W-20 engine oil or equivalent Pennzoil® or Shell Helix® is recommended for all operating temperatures. This engine oil improves low temperature

starting and vehicle fuel economy. Your engine oil filler cap also states the recommended engine oil viscosity grade for your engine.

Lubricants which do not have both the engine oil certification mark and the correct SAE viscosity grade number should not be used.

### **Materials Added To Engine Oil**

The manufacturer strongly recommends against the addition of any additives (other than leak detection dyes) to the engine oil. Engine oil is an engineered product and its performance may be impaired by supplemental additives.

### **Disposing Of Used Engine Oil And Oil Filters**

Care should be taken in disposing of used engine oil and oil filters from your vehicle. Used oil and oil filters, indiscriminately discarded, can present a problem to the environment. Contact your authorized dealer, service



station or governmental agency for advice on how and where used oil and oil filters can be safely discarded in your area.

### **Engine Oil Filter**

The engine oil filter should be replaced with a new filter at every engine oil change.

### **Engine Oil Filter Selection**

This manufacturer's engines have a full-flow type oil filter. Use a filter of this type for replacement. The quality of replacement filters varies considerably. Only high quality filters should be used to assure most efficient service. MOPAR® engine oil filters are a high quality oil filter and are recommended.

### **Engine Air Cleaner Filter**

Refer to the "Maintenance Schedule" for the proper maintenance intervals.

## **WARNING!**

**The air induction system (air cleaner, hoses, etc.) can provide a measure of protection in the case of engine backfire. Do not remove the air induction system (air cleaner, hoses, etc.) unless such removal is necessary for repair or maintenance. Make sure that no one is near the engine compartment before starting the vehicle with the air induction system (air cleaner, hoses, etc.) removed. Failure to do so can result in serious personal injury.**

### **Engine Air Cleaner Filter Selection**

The quality of replacement engine air cleaner filters varies considerably. Only high quality filters should be used to assure most efficient service. MOPAR® engine air cleaner filters are a high quality filter and are recommended.

## Tires

### Checking For Tire Wear

Once a month, check the tire inflation pressures and look for unusual wear or damage. Rotate at the first sign of irregular wear, even if it occurs before the oil indicator system turns on.

### Maintenance-Free Battery

Your vehicle is equipped with a maintenance-free battery. You will never have to add water, nor is periodic maintenance required.

## WARNING!

- Battery fluid is a corrosive acid solution and can burn or even blind you. Do not allow battery fluid to contact your eyes, skin, or clothing. Do not lean over a battery when attaching clamps. If acid splashes in eyes or on skin, flush the area immediately with large amounts of water. Refer to "Jump-Starting Procedures" in "What To Do In Emergencies" for further information.
- Battery gas is flammable and explosive. Keep flame or sparks away from the battery. Do not use a booster battery or any other booster source with an output greater than 12 Volts. Do not allow cable clamps to touch each other.
- Battery posts, terminals, and related accessories contain lead and lead compounds. Wash hands after handling.

*(Continued)*

**WARNING! (Continued)**

- The battery in this vehicle has a vent hose that should not be disconnected and should only be replaced with a battery of the same type (vented).

**CAUTION!**

- It is essential when replacing the cables on the battery that the positive cable is attached to the positive post and the negative cable is attached to the negative post. Battery posts are marked positive (+) and negative (-) and are identified on the battery case. Cable clamps should be tight on the terminal posts and free of corrosion.
- If a “fast charger” is used while the battery is in the vehicle, disconnect both vehicle battery cables before connecting the charger to the battery. Do not use a “fast charger” to provide starting voltage.

**Air Conditioner Maintenance**

For best possible performance, your air conditioner should be checked and serviced by an authorized dealer at the start of each warm season. This service should include cleaning of the condenser fins and a performance test. Drive belt tension should also be checked at this time.

**CAUTION!**

Do not use chemical flushes in your air conditioning system as the chemicals can damage your air conditioning components. Such damage is not covered by the New Vehicle Limited Warranty.

**WARNING!**

- Use only refrigerants and compressor lubricants approved by the manufacturer for your air conditioning system. Some unapproved refrigerants are flammable and can explode, injuring you. Other unapproved refrigerants or lubricants can cause the system to fail, requiring costly repairs. Refer to Warranty Information Book, located on the DVD, for further warranty information.
- The air conditioning system contains refrigerant under high pressure. To avoid risk of personal injury or damage to the system, adding refrigerant or any repair requiring lines to be disconnected should be done by an experienced technician.

**Refrigerant Recovery And Recycling R134a — If Equipped**

R-134a Air Conditioning Refrigerant is a hydrofluorocarbon (HFC) that is endorsed by the Environmental Protection Agency and is an ozone-saving product. However, the manufacturer recommends that air conditioning service be performed by authorized dealer or other service facilities using recovery and recycling equipment.

**NOTE:** Use only manufacturer approved A/C system PAG compressor oil, and refrigerants.

**Refrigerant Recovery And Recycling HFO 1234yf — If Equipped**

HFO 1234yf Air Conditioning Refrigerant is a hydrofluorocarbon (HFC) that is endorsed by the Environmental Protection Agency and is an ozone-saving product with a low GWP (Global Warming Potential). However,

the manufacturer recommends that air conditioning service be performed by authorized dealer or other service facilities using recovery and recycling equipment.

**NOTE:** Use only manufacturer approved A/C system PAG compressor oil, and refrigerants.

### A/C Air Filter

Refer to the "Maintenance Schedule" for the proper maintenance intervals.

#### WARNING!

Do not remove the A/C air filter while the blower is operating or personal injury may result.

The A/C air filter is located in the fresh air inlet on the lower right of center console. Perform the following procedure to replace the filter:

1. Remove the passenger side console closeout. (located on the right side of the center console).



Passenger Side Console Closeout

2. Disengage the retaining tab that secures the filter cover to the HVAC housing, and remove the cover.

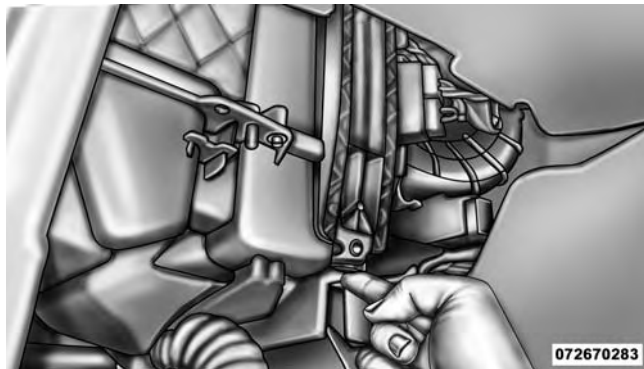

**Filter Cover Retaining Tab**

3. Remove the A/C air filter by pulling it straight out of the housing. Take note of the air filter position indicators.

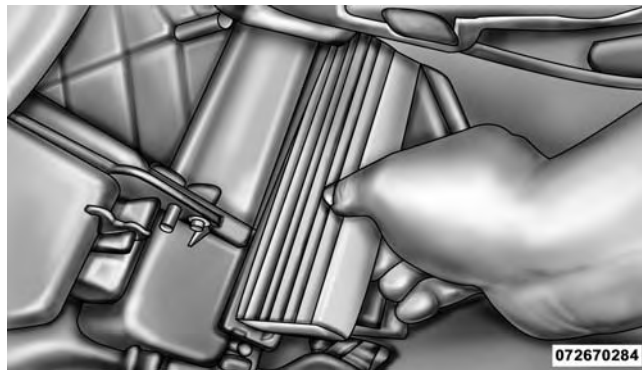

**Air Conditioning Filter Removal**

4. Install the A/C air filter with the air filter position indicators pointing in the same direction as removal. When installing the filter cover, make sure the retaining tab fully engages the cover.

**CAUTION!**

The A/C air filter is identified with an arrow to indicate airflow direction through the filter. Failure to properly install the filter will result in the need to replace it more often.

5. Install the passenger side console closeout.

**NOTE:** Use only manufacturer approved A/C system sealers, stop leak products, seal conditioners, compressor oil, or refrigerants.

**Body Lubrication**

Locks and all body pivot points, including such items as seat tracks, door hinge pivot points and rollers, liftgate, tailgate, sliding doors and hood hinges, should be lubricated periodically with a lithium based grease, such as MOPAR® Spray White Lube to assure quiet, easy operation and to protect against rust and wear. Prior to the

application of any lubricant, the parts concerned should be wiped clean to remove dust and grit; after lubricating excess oil and grease should be removed. Particular attention should also be given to hood latching components to ensure proper function. When performing other underhood services, the hood latch, release mechanism and safety catch should be cleaned and lubricated.

The external lock cylinders should be lubricated twice a year, preferably in the Fall and Spring. Apply a small amount of a high quality lubricant, such as MOPAR® Lock Cylinder Lubricant directly into the lock cylinder.

**Windshield Wiper Blades**

Clean the rubber edges of the wiper blades and the windshield periodically with a sponge or soft cloth and a mild nonabrasive cleaner. This will remove accumulations of salt or road film.

Operation of the wipers on dry glass for long periods may cause deterioration of the wiper blades. Always use washer fluid when using the wipers to remove salt or dirt from a dry windshield.

Avoid using the wiper blades to remove frost or ice from the windshield. Keep the blade rubber out of contact with petroleum products such as engine oil, gasoline, etc.

**NOTE:** Life expectancy of wiper blades varies depending on geographical area and frequency of use. Poor performance of blades may be present with chattering, marks, water lines or wet spots. If any of these conditions are present, clean the wiper blades or replace as necessary.

### **Adding Washer Fluid**

The washer fluid reservoir is located in the engine compartment, and the fluid level should be checked at regular intervals. Fill the reservoir with windshield washer solvent only (not radiator antifreeze).

When refilling the washer fluid reservoir, take some washer fluid and apply it to a cloth or towel and wipe clean the wiper blades, this will help blade performance. To prevent freeze-up of your windshield washer system in cold weather, select a solution or mixture that meets or exceeds the temperature range of your climate. This rating information can be found on most washer fluid containers.

### **WARNING!**

**Commercially available windshield washer solvents are flammable. They could ignite and burn you. Care must be exercised when filling or working around the washer solution.**



## Exhaust System

The best protection against carbon monoxide entry into the vehicle body is a properly maintained engine exhaust system.

If you notice a change in the sound of the exhaust system; or if the exhaust fumes can be detected inside the vehicle; or when the underside or rear of the vehicle is damaged; have an authorized technician inspect the complete exhaust system and adjacent body areas for broken, damaged, deteriorated, or mispositioned parts. Open seams or loose connections could permit exhaust fumes to seep into the passenger compartment. In addition, have the exhaust system inspected each time the vehicle is raised for lubrication or oil change. Replace as required.

### WARNING!

- Exhaust gases can injure or kill. They contain carbon monoxide (CO), which is colorless and odorless. Breathing it can make you unconscious and can eventually poison you. To avoid breathing CO, refer to "Safety Tips/Exhaust Gas" in "Things To Know Before Starting Your Vehicle" for further information.
- A hot exhaust system can start a fire if you park over materials that can burn. Such materials might be grass or leaves coming into contact with your exhaust system. Do not park or operate your vehicle in areas where your exhaust system can contact anything that can burn.

**CAUTION!**

- **The catalytic converter requires the use of unleaded fuel only. Leaded gasoline will destroy the effectiveness of the catalyst as an emissions control device and may seriously reduce engine performance and cause serious damage to the engine.**
- **Damage to the catalytic converter can result if your vehicle is not kept in proper operating condition. In the event of engine malfunction, particularly involving engine misfire or other apparent loss of performance, have your vehicle serviced promptly. Continued operation of your vehicle with a severe malfunction could cause the converter to overheat, resulting in possible damage to the converter and vehicle.**

Under normal operating conditions, the catalytic converter will not require maintenance. However, it is important to keep the engine properly tuned to assure proper catalyst operation and prevent possible catalyst damage.

**NOTE:** Intentional tampering with emissions control systems can result in civil penalties being assessed against you.

In unusual situations involving grossly malfunctioning engine operation, a scorching odor may suggest severe and abnormal catalyst overheating. If this occurs, stop the vehicle, turn off the engine and allow it to cool. Service, including a tune-up to manufacturer's specifications, should be obtained immediately.

To minimize the possibility of catalytic converter damage:

- Do not shut off the engine or interrupt the ignition, when the transmission is in gear and the vehicle is in motion.
- Do not try to start the engine by pushing or towing the vehicle.
- Do not idle the engine with any spark plug wires disconnected or removed, such as when diagnostic testing, or for prolonged periods during very rough idle or malfunctioning operating conditions.

## Cooling System

### **WARNING!**

- When working near the radiator cooling fan, disconnect the fan motor lead or turn the ignition switch to the OFF position. The fan is temperature controlled and can start at any time the ignition switch is in the ON position.
- You or others can be badly burned by hot engine coolant (antifreeze) or steam from your radiator. If you see or hear steam coming from under the hood, do not open the hood until the radiator has had time to cool. Never try to open a cooling system pressure cap when the radiator is hot.

## Coolant Checks

Check engine coolant (antifreeze) protection every 12 months (before the onset of freezing weather, where applicable). If the engine coolant (antifreeze) is dirty or rusty in appearance, the system should be drained, flushed and refilled with fresh engine coolant (antifreeze). Check the front of the A/C condenser for any accumulation of bugs, leaves, etc. If dirty, clean by gently spraying water from a garden hose vertically down the face of the condenser.

## Cooling System — Drain, Flush And Refill

If the engine coolant (antifreeze) is dirty or contains visible sediment, have an authorized dealer clean and flush with OAT coolant (antifreeze) (conforming to MS-12106).

Refer to the “Maintenance Schedule” for the proper maintenance intervals.

**NOTE:** Some vehicles require special tools to add coolant properly. Failure to fill these systems properly could lead to severe internal engine damage. If any coolant is needed to be added to the system please contact your local authorized dealer.

## Selection Of Coolant

Refer to “Fluids, Lubricants, and Genuine Parts” in “Maintaining Your Vehicle” for further information.

**CAUTION!**

- Mixing of engine coolant (antifreeze) other than specified Organic Additive Technology (OAT) engine coolant (antifreeze), may result in engine damage and may decrease corrosion protection. Organic Additive Technology (OAT) engine coolant is different and should not be mixed with Hybrid Organic Additive Technology (HOAT) engine coolant (antifreeze) or any “globally compatible” coolant (antifreeze). If a non-OAT engine coolant (antifreeze) is introduced into the cooling system in an emergency, the cooling system will need to be drained, flushed, and refilled with fresh OAT coolant (conforming to MS-12106), by an authorized dealer as soon as possible.

*(Continued)*

**CAUTION! (Continued)**

- Do not use water alone or alcohol-based engine coolant (antifreeze) products. Do not use additional rust inhibitors or antirust products, as they may not be compatible with the radiator engine coolant and may plug the radiator.
- This vehicle has not been designed for use with propylene glycol-based engine coolant (antifreeze). Use of propylene glycol-based engine coolant (antifreeze) is not recommended.

**Adding Coolant**

Your vehicle has been built with an improved engine coolant (OAT coolant conforming to MS-12106) that allows extended maintenance intervals. This engine coolant (antifreeze) can be used up to ten years or 150,000 miles (240,000 km) before replacement. To prevent reducing this extended maintenance period, it is important that

you use the same engine coolant (OAT coolant conforming to MS-12106) throughout the life of your vehicle.

Please review these recommendations for using Organic Additive Technology (OAT) engine coolant (antifreeze) that meets the requirements of Chrysler Material Standard MS-12106. When adding engine coolant (antifreeze):

- We recommend using MOPAR® Antifreeze/Coolant 10 Year/150,000 Mile Formula OAT (Organic Additive Technology) that meets the requirements of Chrysler Material Standard MS-12106.
- Mix a minimum solution of 50% OAT engine coolant that meets the requirements of Chrysler Material Standard MS-12106 and distilled water. Use higher concentrations (not to exceed 70%) if temperatures below  $-34^{\circ}\text{F}$  ( $-37^{\circ}\text{C}$ ) are anticipated.

- Use only high purity water such as distilled or deionized water when mixing the water/engine coolant (antifreeze) solution. The use of lower quality water will reduce the amount of corrosion protection in the engine cooling system.

Please note that it is the owner's responsibility to maintain the proper level of protection against freezing according to the temperatures occurring in the area where the vehicle is operated.

**NOTE:**

- Some vehicles require special tools to add coolant properly. Failure to fill these systems properly could lead to severe internal engine damage. If any coolant is needed to be added to the system please contact your local authorized dealer.

- Mixing engine coolant (antifreeze) types is not recommended and can result in cooling system damage. If HOAT and OAT coolant are mixed in an emergency, have a authorized dealer drain, flush, and refill with OAT coolant (conforming to MS-12106) as soon as possible.

### Cooling System Pressure Cap

The cap must be fully tightened to prevent loss of engine coolant (antifreeze).

The cap should be inspected and cleaned if there is any accumulation of foreign material on the sealing surfaces.

### WARNING!

- The warning words “DO NOT OPEN HOT” on the cooling system pressure cap are a safety precaution. Never add engine coolant (antifreeze) when the engine is overheated. Do not loosen or remove the cap to cool an overheated engine. Heat causes pressure to build up in the cooling system. To prevent scalding or injury, do not remove the pressure cap while the system is hot or under pressure.
- Do not use a pressure cap other than the one specified for your vehicle. Personal injury or engine damage may result.

## Disposal Of Used Engine Coolant

Used ethylene glycol-based engine coolant (antifreeze) is a regulated substance requiring proper disposal. Check with your local authorities to determine the disposal rules for your community. To prevent ingestion by animals or children, do not store ethylene glycol-based engine coolant in open containers or allow it to remain in puddles on the ground. If ingested by a child or pet, seek emergency assistance immediately. Clean up any ground spills immediately.

## Coolant Level

The coolant expansion bottle provides a quick visual method for determining that the coolant level is adequate. With the engine off and cold, the level of the engine coolant (antifreeze) in the bottle should be between the "MAX" and "MIN" lines marked on the bottle.

As long as the engine operating temperature is satisfactory, the coolant bottle need only be checked once a month.

When additional engine coolant (antifreeze) is needed to maintain the proper level, it should be added to the coolant bottle. Do not overfill.

## Points To Remember

**NOTE:** When the vehicle is stopped after a few miles/kilometers of operation, you may observe vapor coming from the front of the engine compartment. This is normally a result of moisture from rain, snow, or high humidity accumulating on the radiator and being vaporized when the thermostat opens, allowing hot engine coolant (antifreeze) to enter the radiator.

If an examination of your engine compartment shows no evidence of radiator or hose leaks, the vehicle may be safely driven. The vapor will soon dissipate.



- Do not overfill the coolant expansion bottle.
- Check the coolant freeze point in the radiator and in the coolant expansion bottle. If engine coolant (antifreeze) needs to be added, the contents of the coolant expansion bottle must also be protected against freezing.
- If frequent engine coolant (antifreeze) additions are required, the cooling system should be pressure tested for leaks.
- Maintain engine coolant (antifreeze) concentration at a minimum of 50% OAT coolant (conforming to MS-12106) and distilled water for proper corrosion protection of your engine which contains aluminum components.
- Make sure that the coolant expansion bottle overflow hoses are not kinked or obstructed.
- Keep the front of the radiator clean. If your vehicle is equipped with air conditioning, keep the front of the condenser clean.
- Do not change the thermostat for Summer or Winter operation. If replacement is ever necessary, install **ONLY** the correct type thermostat. Other designs may result in unsatisfactory engine coolant (antifreeze) performance, poor gas mileage, and increased emissions.

### **Brake System**

In order to assure brake system performance, all brake system components should be inspected periodically. Refer to the "Maintenance Schedule" for the proper maintenance intervals.

**WARNING!**

Riding the brakes can lead to brake failure and possibly a collision. Driving with your foot resting or riding on the brake pedal can result in abnormally high brake temperatures, excessive lining wear, and possible brake damage. You would not have your full braking capacity in an emergency.

**Brake Master Cylinder**

The fluid level in the master cylinder should be checked when performing under hood services, or immediately if the brake system warning light is on.

Be sure to clean the top of the master cylinder area before removing the cap. If necessary, add fluid to bring the fluid level up to the requirements described on the brake fluid reservoir. Fluid level can be expected to fall as the brake pads wear. The brake fluid level should be checked

when the pads are replaced. However, low fluid level may be caused by a leak and a checkup may be needed.

**NOTE:** If your vehicle is equipped with a **manual transmission**, the brake fluid reservoir supplies fluid to both the brake system and the clutch release system. The two systems are separated in the reservoir, and a leak in one system will not affect the other system. The **manual transmission** clutch release system should not require fluid replacement during the life of the vehicle. If the brake fluid reservoir is low and the brake system does not indicate any leaks or other problems, it may be a result of a leak in the hydraulic clutch release system. See your local authorized dealer for service.

Use only manufacturer's recommended brake fluid. Refer to "Fluids, Lubricants, and Genuine Parts" in "Maintaining Your Vehicle" for further information.

**WARNING!**

- Use only manufacturer's recommended brake fluid. Refer to "Fluids, Lubricants, and Genuine Parts" in "Maintaining Your Vehicle" for further information. Using the wrong type of brake fluid can severely damage your brake system and/or impair its performance. The proper type of brake fluid for your vehicle is also identified on the original factory installed hydraulic master cylinder reservoir.

*(Continued)*

**WARNING! (Continued)**

- To avoid contamination from foreign matter or moisture, use only new brake fluid or fluid that has been in a tightly closed container. Keep the master cylinder reservoir cap secured at all times. Brake fluid in an open container absorbs moisture from the air resulting in a lower boiling point. This may cause it to boil unexpectedly during hard or prolonged braking, resulting in sudden brake failure. This could result in a collision.
- Overfilling the brake fluid reservoir can result in spilling brake fluid on hot engine parts, causing the brake fluid to catch fire. Brake fluid can also damage painted and vinyl surfaces, care should be taken to avoid its contact with these surfaces.

*(Continued)*

**WARNING! (Continued)**

- Do not allow petroleum based fluid to contaminate the brake fluid. Brake seal components could be damaged, causing partial or complete brake failure. This could result in a collision.

**CAUTION!**

Use of improper brake fluids will affect overall clutch system performance. Improper brake fluids may damage the clutch system resulting in loss of clutch function and the ability to shift the transmission.

**Automatic Transmission — If Equipped****Selection Of Lubricant**

It is important to use the proper transmission fluid to ensure optimum transmission performance and life. Use

only the manufacturer's specified transmission fluid. Refer to "Fluids, Lubricants, and Genuine Parts" in this section for fluid specifications. It is important to maintain the transmission fluid at the correct level using the recommended fluid.

**CAUTION!**

Using a transmission fluid other than the manufacturer's recommended fluid may cause deterioration in transmission shift quality, and will require more frequent fluid and filter changes. Refer to "Fluids, Lubricants, and Genuine Parts" in this section for fluid specifications.

No chemical flushes should be used in any transmission; only the approved lubricant should be used.

## Special Additives

The manufacturer strongly recommends against using any special additives in the transmission.

Automatic Transmission Fluid (ATF) is an engineered product and its performance may be impaired by supplemental additives. Therefore, do not add any fluid additives to the transmission. The only exception to this policy is the use of special dyes for diagnosing fluid leaks. Avoid using transmission sealers as they may adversely affect seals.

### CAUTION!

Do not use chemical flushes in your transmission as the chemicals can damage your transmission components. Such damage is not covered by the New Vehicle Limited Warranty.

## Fluid Level Check

The fluid level is preset at the factory and does not require adjustment under normal operating conditions. Routine fluid level checks are not required, therefore the transmission has no dipstick. Your authorized dealer can check your transmission fluid level using special service tools. If you notice fluid leakage or transmission malfunction, visit your authorized dealer immediately to have the fluid level checked. Operating the vehicle with an improper fluid level can cause severe transmission damage.

### CAUTION!

If a transmission fluid leak occurs, visit your authorized dealer immediately. Severe transmission damage may occur. Your authorized dealer has the proper tools to adjust the fluid level accurately.

## Fluid and Filter Changes

Under normal operating conditions, the fluid installed at the factory will provide satisfactory lubrication for the life of the vehicle. However, if the vehicle is used for frequent trailer towing, police, fleet, taxi, etc., change the fluid as indicated in the Maintenance Schedule. In addition, change the fluid (and filter, if equipped) if the fluid becomes contaminated (with water, etc.), or if the transmission is disassembled for any reason.

## Manual Transmission — If Equipped

### Lubricant Selection

Use only the manufacturers recommended transmission fluid. Refer to “Fluids, Lubricants, and Genuine Parts” in “Maintaining Your Vehicle” for further information.

### Fluid Level Check

The transmission is designed to be fill for life. The oil does not need to be check unless there is an oil leak.

Should the transmission be leaking oil, the transmission should be serviced to correct the condition.

## Frequency Of Fluid Change

Under normal operating conditions, the fluid installed at the factory will give satisfactory lubrication for the life of the vehicle. Fluid changes are not necessary unless lubricant has become contaminated with water.

**NOTE:** If contaminated with water, the fluid should be changed immediately.

## Appearance Care And Protection From Corrosion

### Protection Of Body And Paint From Corrosion

Vehicle body care requirements vary according to geographic locations and usage. Chemicals that make roads passable in snow and ice, and chemicals that are sprayed on trees and road surfaces during other seasons, are highly corrosive to the metal in your vehicle. Outside

parking, which exposes your vehicle to airborne contaminants, road surfaces on which the vehicle is operated, extreme hot or cold weather and other extreme conditions will have an adverse effect on paint, metal trim, and underbody protection.

The following maintenance recommendations will enable you to obtain maximum benefit from the corrosion resistance built into your vehicle.

### What Causes Corrosion?

Corrosion is the result of deterioration or removal of paint and protective coatings from your vehicle.

The most common causes are:

- Road salt, dirt and moisture accumulation.
- Stone and gravel impact.
- Insects, tree sap and tar.
- Salt in the air near seacoast localities.

- Atmospheric fallout/industrial pollutants.

### Washing

- Wash your vehicle regularly. Always wash your vehicle in the shade using MOPAR® Car Wash, or a mild car wash soap, and rinse the panels completely with clear water.
- If insects, tar, or other similar deposits have accumulated on your vehicle, use MOPAR® Super Kleen Bug and Tar Remover to remove.
- Use a high quality cleaner wax, such as MOPAR® Cleaner Wax to remove road film, stains and to protect your paint finish. Take care never to scratch the paint.
- Avoid using abrasive compounds and power buffing that may diminish the gloss or thin out the paint finish.

**CAUTION!**

- Do not use abrasive or strong cleaning materials such as steel wool or scouring powder that will scratch metal and painted surfaces.
- Use of power washers exceeding 1,200 psi (8 274 kPa) can result in damage or removal of paint and decals.

**Special Care**

- If you drive on salted or dusty roads or if you drive near the ocean, hose off the undercarriage at least once a month.
  - It is important that the drain holes in the lower edges of the doors, rocker panels, and trunk be kept clear and open.
- If you detect any stone chips or scratches in the paint, touch them up immediately. The cost of such repairs is considered the responsibility of the owner.
  - If your vehicle is damaged due to a collision or similar cause that destroys the paint and protective coating, have your vehicle repaired as soon as possible. The cost of such repairs is considered the responsibility of the owner.
  - If you carry special cargo such as chemicals, fertilizers, de-icer salt, etc., be sure that such materials are well packaged and sealed.
  - If a lot of driving is done on gravel roads, consider mud or stone shields behind each wheel.
  - Use MOPAR® Touch Up Paint on scratches as soon as possible. Your authorized dealer has touch up paint to match the color of your vehicle.



## Wheel And Wheel Trim Care

- All wheels and wheel trim, especially aluminum and chrome plated wheels, should be cleaned regularly with a mild soap and water to prevent corrosion.
- To remove heavy soil and/or excessive brake dust, use MOPAR® Wheel Cleaner.

**NOTE:** If your vehicle is equipped with Dark Vapor Chrome wheels **DO NOT USE** wheel cleaners, abrasives or polishing compounds. They will permanently damage this finish and such damage is not covered by the New Vehicle Limited Warranty. **USE ONLY MILD SOAP AND WATER WITH A SOFT CLOTH.** Used on a regular basis this is all that is required to maintain this finish.

### CAUTION!

**Do not use scouring pads, steel wool, a bristle brush, or metal polishes. Do not use oven cleaner. These products may damage the wheel's protective finish. Avoid automatic car washes that use acidic solutions or harsh brushes that may damage the wheel's protective finish. Only MOPAR® Wheel Cleaner or equivalent is recommended.**

## Stain Repel Fabric Cleaning Procedure — If Equipped

Stain Repel seats may be cleaned in the following manner:

- Remove as much of the stain as possible by blotting with a clean, dry towel.
- Blot any remaining stain with a clean, damp towel.

- For tough stains, apply MOPAR® Total Clean or equivalent, or a mild soap solution to a clean, damp cloth and remove the stain. Use a fresh, damp towel to remove soap residue.
- For grease stains, apply MOPAR® Multi-Purpose Cleaner or equivalent to a clean, damp cloth and remove the stain. Use a fresh, damp towel to remove soap residue.
- Do not use any harsh solvents or any other form of protectants on Stain Repel products.

### Interior Care

Use MOPAR® Fabric Cleaner or equivalent to clean fabric upholstery and MOPAR® Carpet Cleaner or equivalent for carpeting.

Interior Trim should be cleaned starting with a damp cloth, or MOPAR® Satin Select or equivalent. Do not use harsh cleaners or Armor All®. Use MOPAR® Total Clean or equivalent to clean vinyl upholstery.

MOPAR® Total Clean or equivalent is specifically recommended for leather upholstery.

Your leather upholstery can be best preserved by regular cleaning with a damp soft cloth. Small particles of dirt can act as an abrasive and damage the leather upholstery and should be removed promptly with a damp cloth. Stubborn soils can be removed easily with a soft cloth and MOPAR® Total Clean or equivalent. Care should be taken to avoid soaking your leather upholstery with any liquid. Please do not use polishes, oils, cleaning fluids, solvents, detergents, or ammonia-based cleaners to clean your leather upholstery. Application of a leather conditioner is not required to maintain the original condition.

**WARNING!**

**Do not use volatile solvents for cleaning purposes. Many are potentially flammable, and if used in closed areas they may cause respiratory harm.**

**Cleaning Headlights**

Your vehicle has plastic headlights that are lighter and less susceptible to stone breakage than glass headlights.

Plastic is not as scratch resistant as glass and therefore different lens cleaning procedures must be followed.

To minimize the possibility of scratching the lenses and reducing light output, avoid wiping with a dry cloth. To remove road dirt, wash with a mild soap solution followed by rinsing.

Do not use abrasive cleaning components, solvents, steel wool or other aggressive material to clean the lenses.

**Glass Surfaces**

All glass surfaces should be cleaned on a regular basis with MOPAR® Glass Cleaner or any commercial household-type glass cleaner. Never use an abrasive type cleaner. Use caution when cleaning the inside rear window equipped with electric defrosters or the right rear quarter window equipped with the radio antenna. Do not use scrapers or other sharp instruments that may scratch the elements.

When cleaning the rear view mirror, spray cleaner on the towel or rag that you are using. Do not spray cleaner directly on the mirror.

**Instrument Panel Cover**

The instrument panel cover has a low glare surface which minimizes reflections on the windshield. Do not use protectants or other products which may cause undesirable reflections. Use soap and warm water to restore the low glare surface.

## Instrument Panel Bezels

### CAUTION!

When installing hanging air fresheners in your vehicle, read the installation instructions carefully. Some air fresheners will damage the finish of painted or decorated parts if allowed to directly contact any surface.

## Cleaning Plastic Instrument Cluster Lenses

The lenses in front of the instruments in this vehicle are molded in clear plastic. When cleaning the lenses, care must be taken to avoid scratching the plastic.

1. Clean with a wet soft rag or micro-fiber towel. A mild soap solution may be used, but do not use high alcohol content or abrasive cleaners. If soap is used, wipe clean with a clean damp rag.

2. Dry with a soft cloth.

## Seat Belt Maintenance

Do not bleach, dye, or clean the belts with chemical solvents or abrasive cleaners. This will weaken the fabric. Sun damage can also weaken the fabric.

If the belts need cleaning, use MOPAR® Total Clean, a mild soap solution, or lukewarm water. Do not remove the belts from the vehicle to wash them. Dry with a soft cloth.

Replace the belts if they appear frayed or worn or if the buckles do not work properly.

## FUSES

### WARNING!

- When replacing a blown fuse, always use an appropriate replacement fuse with the same amp rating as the original fuse. Never replace a fuse with another fuse of higher amp rating. Never replace a blown fuse with metal wires or any other material. Failure to use proper fuses may result in serious personal injury, fire and/or property damage.
- Before replacing a fuse, make sure that the ignition is off and that all the other services are switched off and/or disengaged.
- If the replaced fuse blows again, contact an authorized dealer.
- If a general protection fuse for safety systems (air bag system, braking system), power unit systems (engine system, gearbox system) or steering system blows, contact an authorized dealer.

## Interior Fuses

The interior fuses are located on the drivers side under the instrument panel.

Cavity	Cartridge Fuse	Mini Fuse	Description
F1	—	20 Amp Yellow	Front Heated Seats - If Equipped
F2	—	20 Amp Yellow	Rear Heated Seats, Heated Steering Wheel - If Equipped
F3	—	10 Amp Red	Park Assist Module, Rear Camera, Left and Right Blind Spot Sensor, Compass - If Equipped

Cavity	Cartridge Fuse	Mini Fuse	Description
F4	—	15 Amp Blue	Instrument Cluster
F5	—	10 Amp Red	HVAC, Humidity Sensor, In-Car Temperature Sensor, Inside Mirror Assembly
F18	—	15 Amp Blue	Radio
F19	—	10 Amp Red	Fuel Door
F20	—	10 Amp Red	Steering Column Control Module, Switch Bank

Cavity	Cartridge Fuse	Mini Fuse	Description
F21	—	10 Amp Red	Diagnostic Port
F22	—	10 Amp Red	Universal Garage Door Opener, EOM
F23	—	20 Amp Yellow	Sunroof
F24	—	5 Amp Tan	Run/Accessory Relay
F25	—	5 Amp Tan	Transmission Control Module #4
F26	—	5 Amp Tan	Stop Lamp Switch
F27	—	10 Amp Red	Pneumatic Lumbar Support

## Underhood Fuses

The Power Distribution Center is located on the right side of the engine compartment, behind the battery.

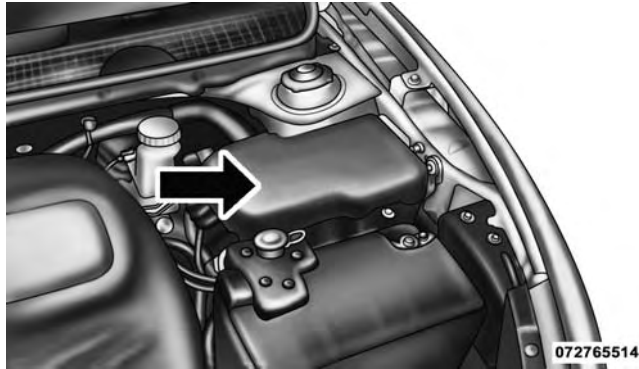

Power Distribution Center

Cavity	Maxi Fuse	Mini Fuse	Description
F01	70 Amp Tan	—	Body Control Module #1
F02	60 Amp Blue	—	Body Control Module #2
F03	30 Amp Green	—	Output For Starter Relay #1
F04	40 Amp Orange	—	ESC Pump Motor
F05	40 Amp Orange	—	Transmission Con- trol Module #1
F06	30 Amp Green	—	Body Control Module #3
F07	40 Amp Orange	—	EBL RLY Coil, Blower Motor RLY Coil

Cavity	Maxi Fuse	Mini Fuse	Description
F09	—	5 Amp Tan	Radiator Fan
F10	—	10 Amp Red	ORC
F11	—	20 Amp Yellow	Run/Start, Engine Control Module
F14	—	15 Amp Blue	Transmission Control Module #2
F15	—	15 Amp Blue	Transmission Control Module #3
F16	—	15 Amp Blue	Engine Control Module, Ignition Coils
F17	—	15 Amp Blue	Brake System Module

Cavity	Maxi Fuse	Mini Fuse	Description
F18	—	20 Amp Yellow	Engine Control Module
F19	—	10 Amp Red	A/C Compressor Clutch
F20	—	30 Amp Green	Rear Defroster (EBL)
F21	—	20 Amp Yellow	Fuel Pump
F22	—	10 Amp Red	Occupant Restraint Controller
F23	—	25 Amp Natural	Brake System Module
F24	—	20 Amp Yellow	Engine Control Module, Fuel Injectors



Cavity	Maxi Fuse	Mini Fuse	Description
F30	—	20 Amp Yellow	Power Outlet (Console)
F81	60 Amp Blue	—	Interior PDC Battery Feed, Power Seats
F82	30 Amp Green	—	Amplifier
F83	40 Amp Orange	—	HVAC Blower Motor
F84	—	20 Amp Yellow	Cigar Lighter

Cavity	Maxi Fuse	Mini Fuse	Description
F85	—	10 Amp Red	Sunroof, LRSM, Power Outlet (Console), UCI/AUX Port, Cigar Lighter
F86	—	20 Amp Yellow	—
F87	—	10 Amp Red	Wastegate, Purge Solenoid, OBD Vent Valve, Oxygen Sensor Heaters
F88	—	10 Amp Red	Heated Outside Mirrors

**Body Control Module (BCM) Fuses**

Cavity	Cartridge Fuse	Mini Fuse	Description
F12	—	—	Spare
F13	—	15 Amp Blue	Left Headlamp
F31	—	—	Spare
F32	—	10 Amp Red	Interior Lighting/ Decklid/Liftgate Release
F33	—	25 Amp Clear	Window Motor – Driver
F34	—	25 Amp Clear	Window Motor – Passenger
F36	—	15 Amp Blue	Intrusion Module

Cavity	Cartridge Fuse	Mini Fuse	Description
F37	—	10 Amp Red	Instrument Panel Cluster
F38	—	20 Amp Yellow	Door Locks
F42	—	—	Spare
F43	—	20 Amp Yellow	Windshield Washer Pump
F47	—	5 Amp Tan	Transmission Control Module (Tcm)
F48	—	20 Amp Yellow	Spare
F49	—	7.5 Amp Brown	Stop Lamp Switch

Cavity	Cartridge Fuse	Mini Fuse	Description
F50	—	7.5 Amp Brown	Pneumatic Lumbar Support
F51	—	7.5 Amp Brown	Cd/Hands-Free Module – Bluetooth/Radio Display
F53	—	7.5 Amp Brown	Driver Window Switch/Power Mirrors
F89	—	5 Amp Tan	Trunk Lamp
F90	—	7.5 Amp Brown	Front Fog Lamps – Right

Cavity	Cartridge Fuse	Mini Fuse	Description
F91	—	7.5 Amp Brown	Front Fog Lamps – Left
F92	—	7.5 Amp Brown	High Beams (Shutters)
F93	—	15 Amp Blue	Right Headlamp

## VEHICLE STORAGE

If you will not be using your vehicle for more than 21 days, you may want to take steps to preserve your battery.

- Disconnect the negative cable from the battery.

- Anytime you store your vehicle, or keep it out of service (i.e., vacation) for two weeks or more, run the air conditioning system at idle for about five minutes in the fresh air and high blower setting. This will ensure adequate system lubrication to minimize the possibility of compressor damage when the system is started again.

**NOTE:** When the vehicle has not been started or driven for at least 35 days, an Extended Park Start Procedure is required to start the vehicle. Refer to “Starting Procedures” in “Starting And Operating” for further information.

## REPLACEMENT BULBS

### Interior Bulbs

	Bulb Number
Dome Lamp	W5W
Overhead Console Lamp	W5W

### Exterior Bulbs

	Bulb Number
Low Beam/High Beam (Bi-Halogen Headlamp)	HIR2
Low Beam/High Beam (Bi-Xenon Headlamp)	D3S
Front Park/Turn Signal Lamp	7442NALL
Sidemarkers Lamp	194
Front Fog Lamp	H11
Center High-Mounted Stop Lamp (CHMSL)	LED (Serviced at Authorized Dealer)
Rear Tail/Stop/Turn Signal Lamp	LED (Serviced at Authorized Dealer)
Backup Lamp	7440
License Lamp	168

## BULB REPLACEMENT

**NOTE:** Lens fogging can occur under certain atmospheric conditions. This will usually clear as atmospheric conditions change to allow the condensation to change back into a vapor. Turning the lamps on will usually accelerate the clearing process.

### Headlamps

#### Halogen Headlamps

Can be serviced by removing the cap from the backside of the headlamp. Remove the HIR2 bulb from the connector and replacing the bulb. Reinstall bulb and cap.

### High Intensity Discharge Headlamps (HID)

The headlamps are a type of high voltage discharge tube. High voltage can remain in the circuit even with the headlamp switch off and the key removed. Because of this, you should not attempt to service a headlamp bulb yourself. If a headlamp bulb fails, take your vehicle to an authorized dealer for service.

#### **WARNING!**

**A transient high voltage occurs at the bulb sockets of HID headlamps when the headlamp switch is turned ON. It may cause serious electrical shock or electrocution if not serviced properly. See your authorized dealer for service.**

## Backup Lamps

1. Open trunk.
2. Remove trim cover.

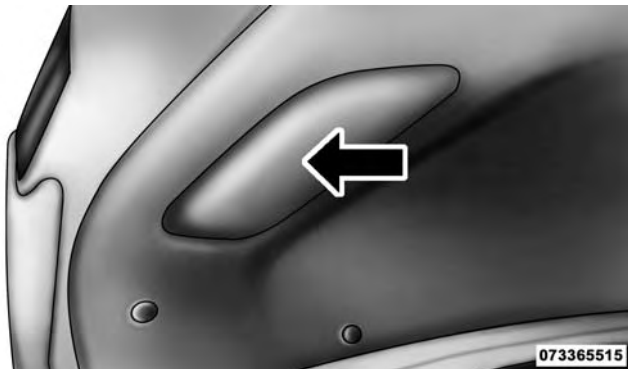

Trim Cover

3. Twist the bulb socket one quarter turn counter clockwise to remove.

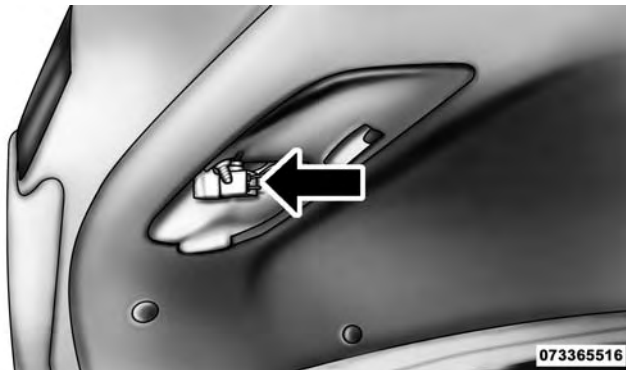

Bulb Socket

4. Replace bulb.



Backup Bulb

5. Twist the bulb socket one quarter turn clockwise to install.
6. Install trim cover.

## License Lamp

1. Remove the screws securing the lamp to the rear fascia.
2. Remove the bulb and socket assembly.
3. Disconnect the bulb from the socket assembly and install the replacement bulb.

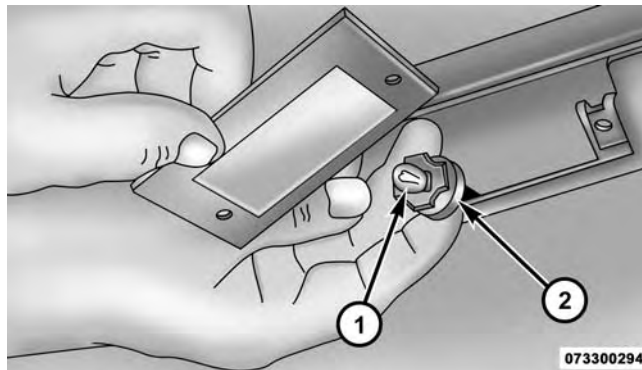

- 1 — License Lamp Bulb  
2 — Socket

4. Reinstall the bulb and socket assembly.
5. Reattach the lamp to the rear fascia, and then install the screws.



## FLUID CAPACITIES

	U.S.	Metric
<b>Fuel (Approximate)</b>		
Fuel (1.4L Engines)	13.2 Gallons	50 Liters
Fuel (2.0L/2.4L Engines)	14.2 Gallons	54 Liters
Fuel (2.4L GT models only)	15.8 Gallons	60 Liters
<b>Engine Oil With Filter</b>		
1.4L Turbo Engine (SAE 5W-40 Synthetic, API Certified)	4 Quarts	3.8 Liters
2.0L Engine (SAE 0W-20, API Certified)	5 Quarts	4.7 Liters
2.4L Engine (SAE 0W-20, API Certified)	5.5 Quarts	5.2 Liters
<b>Cooling System*</b>		
1.4L Turbo Engine (MOPAR® OAT Antifreeze/Engine Coolant 10 Year/150,000 Mile Formula or equivalent)	7.2 Quarts	6.8 Liters
2.0L and 2.4L Engine (MOPAR® OAT Antifreeze/Engine Coolant 10 Year/150,000 Mile Formula or equivalent)	7.2 Quarts	6.8 Liters
* Includes heater and coolant recovery bottle filled to MAX level.		

**FLUIDS, LUBRICANTS AND GENUINE PARTS****Engine**

<b>Component</b>	<b>Fluid, Lubricant, or Genuine Part</b>
Engine Coolant	We recommend you use MOPAR® Antifreeze/Coolant 10 Year/150,000 Mile Formula OAT (Organic Additive Technology) or equivalent meeting the requirements of Chrysler Material Standard MS-12106.
Engine Oil – 1.4L Turbo Engine	We recommend you use SAE 5W-40 API Certified Synthetic Engine Oil, meeting the requirements of Chrysler Material Standard MS-12991 such as MOPAR®, Pennzoil®, and Shell Helix®. Refer to your engine oil filler cap for correct SAE grade. Refer to your engine oil filler cap for correct SAE grade.
Engine Oil – 2.0L and 2.4L Engine	We recommend you use SAE 0W-20 API Certified Engine Oil, meeting the requirements of Chrysler Material Standard MS-6395 such as MOPAR®, Pennzoil®, and Shell Helix®. Refer to your engine oil filler cap for correct SAE grade.
Engine Oil Filter	We recommend you use MOPAR® Engine Oil Filter or equivalent.

<b>Component</b>	<b>Fluid, Lubricant, or Genuine Part</b>
Spark Plugs – 1.4L Turbo Engine	We recommend you use MOPAR® Spark Plugs (Gap 0.026 in [0.65 mm]).
Spark Plugs – 2.0L Engine	We recommend you use MOPAR® Spark Plugs (Gap 0.043 in [1.1 mm]).
Spark Plugs – 2.4L Engine	We recommend you use MOPAR® Spark Plugs (Gap 0.047 in [1.2 mm]).
Fuel Selection – 1.4L Turbo Engine	91 Octane Recommended – 87 Octane Acceptable.
Fuel Selection – 2.0L and 2.4L Engine	87 Octane.

**Chassis**

<b>Component</b>	<b>Fluid, Lubricant, or Genuine Part</b>
Automatic Transmission (1.4L Turbo Engine) – If Equipped	MOPAR® C635 DDCT/MTX Transmission Fluid or equivalent. Failure to use the correct fluid may affect the function or performance of your transmission.
Automatic Transmission (2.0L And 2.4L Engine) – If Equipped	MOPAR® SP-IV Automatic Transmission Fluid or equivalent. Failure to use the correct fluid may affect the function or performance of your transmission
Manual Transmission – If Equipped	We recommend you use MOPAR® C635 DDCT/MTX Transmission Fluid.
Brake Master Cylinder	We recommend you use MOPAR® DOT 3, SAE J1703. If DOT 3, SAE J1703 brake fluid is not available, then DOT 4 is acceptable.

---

# MAINTENANCE SCHEDULES

## CONTENTS

---

- MAINTENANCE SCHEDULE . . . . . .612
  - Required Maintenance . . . . . .613

## MAINTENANCE SCHEDULE

Your vehicle is equipped with an automatic oil change indicator system. The oil change indicator system will remind you that it is time to take your vehicle in for scheduled maintenance.

Based on engine operation conditions, the oil change indicator message will illuminate. This means that service is required for your vehicle. Operating conditions such as frequent short-trips, trailer tow, extremely hot or cold ambient temperatures, and E85 fuel usage will influence when the “Change Oil” message is displayed. Severe Operating Conditions can cause the change oil message to illuminate as early as 3,500 miles (5,600 km) since last reset. Have your vehicle serviced as soon as possible, within the next 500 miles (805 km).

**NOTE:** Under no circumstances should oil change intervals exceed 10,000 miles (16,000 km) or twelve months, whichever comes first.

### Severe Duty All Models

Change Engine Oil at 4000 miles (6,500 km) if the vehicle is operated in a dusty and off road environment. This type of vehicle use is considered Severe Duty.

- *Once A Month Or Before A Long Trip:*

Check engine oil level.

Check windshield washer fluid level.

Check the tire inflation pressures and look for unusual wear or damage.

Check the fluid levels of the coolant reservoir, and brake master cylinder as needed.

Check function of all interior and exterior lights.

## Required Maintenance

Refer to the Maintenance Schedules on the following pages for required maintenance.

### At Every Oil Change Interval As Indicated By Oil Change Indicator System:

- Change engine oil and filter.
- Rotate the tires. **Rotate at the first sign of irregular wear, even if it occurs before the oil indicator system turns on.**
- Inspect battery and clean and tighten terminals as required.

### At Every Oil Change Interval As Indicated By Oil Change Indicator System:

- Inspect brake pads, shoes, rotors, drums, hoses and park brake.
- Inspect engine cooling system protection and hoses.
- Inspect exhaust system.
- Inspect engine air cleaner if using in dusty or off-road conditions.

**Maintenance Chart**

Mileage Or Time Passed (Whichever Comes First)	20,000	30,000	40,000	50,000	60,000	70,000	80,000	90,000	100,000	110,000	120,000	130,000	140,000	150,000
Or Years:	2	3	4	5	6	7	8	9	10	11	12	13	14	15
Or Kilometers:	32,000	48,000	64,000	80,000	96,000	112,000	128,000	144,000	160,000	176,000	192,000	208,000	224,000	240,000
<b>Additional Inspections</b>														
Inspect CV joint boots.		X			X			X			X			X
Inspect front suspension, tie rod ends and replace as necessary.	X		X		X		X		X		X		X	
Inspect brake linings, parking brake function.	X		X		X		X		X		X		X	
<b>Additional Maintenance</b>														
Replace the cabin/air conditioning filter.	X		X		X		X		X		X		X	
Replace the engine air cleaner filter.		X			X			X			X			X
Replace the spark plugs (1.4L Turbo Engine).**		X			X			X			X			X



Mileage Or Time Passed (Whichever Comes First)	20,000	30,000	40,000	50,000	60,000	70,000	80,000	90,000	100,000	110,000	120,000	130,000	140,000	150,000
Or Years:	2	3	4	5	6	7	8	9	10	11	12	13	14	15
Or Kilometers:	32,000	48,000	64,000	80,000	96,000	112,000	128,000	144,000	160,000	176,000	192,000	208,000	224,000	240,000
Replace the spark plugs (2.0L and 2.4L Engine).**									X					
Flush and replace the engine coolant at 10 years or 150,000 miles (240,000 km) whichever comes first.									X					X
Change the transmission fluid (manual, or 1.4L turbo automatic) if using your vehicle for any of the following: trailer towing, heavy loading, taxi, police, delivery service (commercial service), off-road, desert operation or more than 50% of your driving is at sustained speeds during hot weather, above 90°F (32°C).				X					X					X

616 MAINTENANCE SCHEDULES

Mileage Or Time Passed (Whichever Comes First)	20,000	30,000	40,000	50,000	60,000	70,000	80,000	90,000	100,000	110,000	120,000	130,000	140,000	150,000
Or Years:	2	3	4	5	6	7	8	9	10	11	12	13	14	15
Or Kilometers:	32,000	48,000	64,000	80,000	96,000	112,000	128,000	144,000	160,000	176,000	192,000	208,000	224,000	240,000
Change the automatic transmission fluid and filter (2.0L, 2.4L engines only) if you frequently drive: on rough or unpaved roads, on mountain roads, on short trips, in heavy city traffic during hot weather, or while towing a trailer, or if you use the vehicle for police, taxi, or in a commercial fleet.					X						X			
Inspect and replace PCV valve if necessary.									X					
Replace the timing belt (1.4L Turbo Engine).														X

\*\* The spark plug change interval is mileage based only, yearly intervals do not apply.

**WARNING!**

- You can be badly injured working on or around a motor vehicle. Do only service work for which you have the knowledge and the right equipment. If you have any doubt about your ability to perform a service job, take your vehicle to a competent mechanic.
- Failure to properly inspect and maintain your vehicle could result in a component malfunction and effect vehicle handling and performance. This could cause an accident.



# IF YOU NEED CONSUMER ASSISTANCE

## CONTENTS

---

■ SUGGESTIONS FOR OBTAINING SERVICE FOR YOUR VEHICLE . . . . .	.621	□ Customer Assistance For The Hearing Or Speech Impaired (TDD/TTY). . . . .	.623
□ Prepare For The Appointment. . . . .	.621	□ Service Contract . . . . .	.623
□ Prepare A List . . . . .	.621	■ WARRANTY INFORMATION . . . . .	.624
□ Be Reasonable With Requests . . . . .	.621	■ MOPAR® PARTS . . . . .	.625
■ IF YOU NEED ASSISTANCE . . . . .	.621	■ REPORTING SAFETY DEFECTS . . . . .	.625
□ Chrysler Group LLC Customer Center. . . . .	.622	□ In The 50 United States And Washington, D.C. . . . .	.625
□ Chrysler Canada Inc. Customer Center . . . . .	.622	□ In Canada. . . . .	.625
□ In Mexico Contact:. . . . .	.623	■ PUBLICATION ORDER FORMS . . . . .	.626

■ DEPARTMENT OF TRANSPORTATION UNIFORM  
TIRE QUALITY GRADES . . . . .627

□ Treadwear. . . . .627

□ Traction Grades . . . . .628

□ Temperature Grades. . . . .628

## **SUGGESTIONS FOR OBTAINING SERVICE FOR YOUR VEHICLE**

### **Prepare For The Appointment**

If you are having warranty work done, be sure to have the right papers with you. Take your warranty folder. All work to be performed may not be covered by the warranty. Discuss additional charges with the service manager. Keep a maintenance log of your vehicle's service history. This can often provide a clue to the current problem.

### **Prepare A List**

Make a written list of your vehicle's problems or the specific work you want done. If you've had an accident or work done that is not on your maintenance log, let the service advisor know.

### **Be Reasonable With Requests**

If you list a number of items and you must have your vehicle by the end of the day, discuss the situation with the service advisor and list the items in order of priority. At many authorized dealers, you may obtain a rental vehicle at a minimal daily charge. If you need a rental, it is advisable to make these arrangements when you call for an appointment.

## **IF YOU NEED ASSISTANCE**

The manufacturer and its authorized dealer are vitally interested in your satisfaction. We want you to be happy with our products and services.

Warranty service must be done by an authorized dealer. We strongly recommend that you take the vehicle to an authorized dealer. They know your vehicle the best, and are most concerned that you get prompt and high quality service. The manufacturer's authorized dealer have the

facilities, factory-trained technicians, special tools, and the latest information to ensure the vehicle is fixed correctly and in a timely manner.

This is why you should always talk to an authorized dealer service manager first. Most matters can be resolved with this process.

- If for some reason you are still not satisfied, talk to the general manager or owner of the authorized dealer. They want to know if you need assistance.
- If an authorized dealer is unable to resolve the concern, you may contact the manufacturer's customer center.

Any communication to the manufacturer's customer center should include the following information:

- Owner's name and address
- Owner's telephone number (home and office)

- Authorized dealer name
- Vehicle Identification Number (VIN)
- Vehicle delivery date and mileage

**Chrysler Group LLC Customer Center**

P.O. Box 21-8004

Auburn Hills, MI 48321-8004

Phone: (800) 423-6343

**Chrysler Canada Inc. Customer Center**

P.O. Box 1621

Windsor, Ontario N9A 4H6

Phone: (800) 465-2001 English / (800) 387-9983 French



**In Mexico Contact:**

Av. Prolongacion Paseo de la Reforma, 1240

Sante Fe C.P. 05109

Mexico, D. F.

In Mexico City: 5081-7568

Outside Mexico City: 1-800-505-1300

**Customer Assistance For The Hearing Or Speech Impaired (TDD/TTY)**

To assist customers who have hearing difficulties, the manufacturer has installed special TDD (Telecommunication Devices for the Deaf) equipment at its customer center. Any hearing or speech impaired customer, who has access to a TDD or a conventional teletypewriter (TTY) in the United States, can communicate with the manufacturer by dialing 1-800-380-CHRY.

Canadian residents with hearing difficulties that require assistance can use the special needs relay service offered by Bell Canada. For TTY teletypewriter users, dial 711 and for Voice callers, dial 1-800-855-0511 to connect with a Bell Relay Service operator.

**Service Contract**

You may have purchased a service contract for a vehicle to help protect you from the high cost of unexpected repairs after the manufacturer's New Vehicle Limited Warranty expires. The manufacturer stands behind only the manufacturer's service contracts. If you purchased a manufacturer's service contract, you will receive Plan Provisions and an Owner Identification Card in the mail within three weeks of the vehicle delivery date. If you have any questions about the service contract, call the manufacturer's Service Contract National Customer Hotline at 1-800-521-9922 (Canadian residents, call (800) 465-2001 English / (800) 387-9983 French).

The manufacturer will not stand behind any service contract that is not the manufacturer's service contract. It is not responsible for any service contract other than the manufacturer's service contract. If you purchased a service contract that is not a manufacturer's service contract, and you require service after the manufacturer's New Vehicle Limited Warranty expires, please refer to the contract documents, and contact the person listed in those documents.

We appreciate that you have made a major investment when you purchased the vehicle. An authorized dealer has also made a major investment in facilities, tools, and training to assure that you are absolutely delighted with the ownership experience. You will be pleased with their sincere efforts to resolve any warranty issues or related concerns.

**WARNING!**

**Engine exhaust, some of its constituents, and certain vehicle components contain, or emit, chemicals known to the State of California to cause cancer and birth defects, or other reproductive harm. In addition, certain fluids contained in vehicles and certain products of component wear contain, or emit, chemicals known to the State of California to cause cancer and birth defects, or other reproductive harm.**

**WARRANTY INFORMATION**

See the Warranty Information Booklet, located on the DVD, for the terms and provisions of Chrysler Group LLC warranties applicable to this vehicle and market.

## **MOPAR® PARTS**

MOPAR® fluids, lubricants, parts, and accessories are available from an authorized dealer. They are recommended for your vehicle in order to help keep the vehicle operating at its best.

## **REPORTING SAFETY DEFECTS**

### **In The 50 United States And Washington, D.C.**

If you believe that your vehicle has a defect that could cause a crash or cause injury or death, you should immediately inform the National Highway Traffic Safety Administration (NHTSA) in addition to notifying the manufacturer.

If NHTSA receives similar complaints, it may open an investigation, and if it finds that a safety defect exists in a group of vehicles, it may order a recall and remedy

campaign. However, NHTSA cannot become involved in individual problems between you, your authorized dealer, and the manufacturer.

To contact NHTSA, you may either call the Auto Safety Hotline toll free at 1-888-327-4236 (TTY: 1-800-424-9153), or go to <http://www.safercar.gov>; or write to: Administrator, NHTSA, 1200 New Jersey Avenue, SE., West Building, Washington, D.C. 20590. You can also obtain other information about motor vehicle safety from <http://www.safercar.gov>.

### **In Canada**

If you believe that your vehicle has a safety defect, you should contact the Customer Service Department immediately. Canadian customers who wish to report a safety defect to the Canadian government should contact Transport Canada, Motor Vehicle Defect Investigations and Recalls at 1-800-333-0510 or go to <http://www.tc.gc.ca/roadsafety/>

## PUBLICATION ORDER FORMS

To order the following manuals, you may use either the website or the phone numbers listed below. Visa, Mastercard, American Express, and Discover orders are accepted. If you prefer mailing your payment, please call for an order form.

**NOTE:** A street address is required when ordering manuals (no P.O. Boxes).

### Service Manuals

These comprehensive Service Manuals provide the information that students and professional technicians need in diagnosing/troubleshooting, problem solving, maintaining, servicing, and repairing Chrysler Group LLC vehicles. A complete working knowledge of the vehicle, system, and/or components is written in straightforward language with illustrations, diagrams, and charts.

### Diagnostic Procedure Manuals

Diagnostic Procedure Manuals are filled with diagrams, charts and detailed illustrations. These practical manuals make it easy for students and technicians to find and fix problems on computer-controlled vehicle systems and features. They show exactly how to find and correct problems the first time, using step-by-step troubleshooting and drivability procedures, proven diagnostic tests and a complete list of all tools and equipment.

### Owner's Manuals

These Owner's Manuals have been prepared with the assistance of service and engineering specialists to acquaint you with specific Chrysler Group LLC vehicles. Included are starting, operating, emergency and maintenance procedures as well as specifications, capabilities and safety tips.

Call toll free at:

- 1-800-890-4038 (U.S.)
- 1-800-387-1143 (Canada)

Or

Visit us on the Worldwide Web at:

- [www.techauthority.com](http://www.techauthority.com)

## **DEPARTMENT OF TRANSPORTATION UNIFORM TIRE QUALITY GRADES**

The following tire grading categories were established by the National Highway Traffic Safety Administration. The specific grade rating assigned by the tire's manufacturer in each category is shown on the sidewall of the tires on your vehicle.

All passenger car tires must conform to Federal safety requirements in addition to these grades.

## **Treadwear**

The Treadwear grade is a comparative rating, based on the wear rate of the tire when tested under controlled conditions on a specified government test course. For example, a tire graded 150 would wear one and one-half times as well on the government course as a tire graded 100. The relative performance of tires depends upon the actual conditions of their use, however, and may depart significantly from the norm due to variations in driving habits, service practices, and differences in road characteristics and climate.

## Traction Grades

The Traction grades, from highest to lowest, are AA, A, B, and C. These grades represent the tire's ability to stop on wet pavement, as measured under controlled conditions on specified government test surfaces of asphalt and concrete. A tire marked C may have poor traction performance.

### WARNING!

The traction grade assigned to this tire is based on straight-ahead braking traction tests, and does not include acceleration, cornering, hydroplaning, or peak traction characteristics.

## Temperature Grades

The temperature grades are A (the highest), B, and C, representing the tire's resistance to the generation of heat and its ability to dissipate heat, when tested under

controlled conditions on a specified indoor laboratory test wheel. Sustained high temperature can cause the material of the tire to degenerate and reduce tire life, and excessive temperature can lead to sudden tire failure. The grade C corresponds to a level of performance, which all passenger car tires must meet under the Federal Motor Vehicle Safety Standard No. 109. Grades B and A represent higher levels of performance on the laboratory test wheel, than the minimum required by law.

### WARNING!

The temperature grade for this tire is established for a tire that is properly inflated and not overloaded. Excessive speed, under-inflation, or excessive loading, either separately or in combination, can cause heat buildup and possible tire failure.

---

# INDEX

ABS (Anti-Lock Brake System) . . . . .	.447	Alarm Light . . . . .	.316
Adding Engine Coolant (Antifreeze) . . . . .	.579	Alarm, Panic . . . . .	.26
Adding Fuel . . . . .	.497	Alarm (Security Alarm) . . . . .	.21
Adding Washer Fluid . . . . .	.574	Alarm System (Security Alarm) . . . . .	.21
Additives, Fuel . . . . .	.495	Alterations/Modifications, Vehicle . . . . .	.7
Airbag . . . . .	.61	Antifreeze (Engine Coolant) . . . . .	.578
Airbag Deployment . . . . .	.80	Capacities . . . . .	.607
Airbag Light . . . . .	.68	Disposal . . . . .	.582
Airbag Maintenance . . . . .	.82	Anti-Lock Brake System (ABS) . . . . .	.447
Airbag, Side . . . . .	.65	Anti-Lock Warning Light . . . . .	.318
Airbag, Window (Side Curtain) . . . . .	.65	Appearance Care . . . . .	.588
Air Cleaner, Engine (Engine Air Cleaner Filter) . . . . .	.567	Arming System (Security Alarm) . . . . .	.21
Air Conditioner Maintenance . . . . .	.569	Assistance Towing . . . . .	.147
Air Conditioning . . . . .	.388	Assist, Hill Start . . . . .	.452
Air Conditioning Controls . . . . .	.388	Auto Down Power Windows . . . . .	.42
Air Conditioning Filter . . . . .	.402	Automatic Dimming Mirror . . . . .	.119
Air Conditioning Refrigerant . . . . .	.569	Automatic Door Locks . . . . .	.34
Air Conditioning System . . . . .	.388	Automatic Headlights . . . . .	.235
Air Pressure, Tires . . . . .	.470	Automatic Temperature Control (ATC) . . . . .	.399



Automatic Transmission . . . . .	.416	Pair (Link) Uconnect® Phone To A Mobile Phone . . . . .	.168
Adding Fluid . . . . .	.587	Body Mechanism Lubrication . . . . .	.573
Fluid and Filter Changes . . . . .	.588	B-Pillar Location . . . . .	.464
Fluid Level Check . . . . .	.587	Brake Assist System . . . . .	.449
Fluid Type . . . . .	.586	Brake Control System, Electronic . . . . .	.446
Gear Ranges . . . . .	.420	Brake Fluid . . . . .	.610
Special Additives . . . . .	.587	Brake, Parking . . . . .	.442
Autostick . . . . .	.438	Brake System . . . . .	.583
Auto Unlock, Doors . . . . .	.34	Anti-Lock (ABS) . . . . .	.447
Auto Up Power Windows . . . . .	.43	Master Cylinder . . . . .	.584
Battery . . . . .	.568	Warning Light . . . . .	.313
Keyless Transmitter Replacement (RKE) . . . . .	.27	Brake/Transmission Interlock . . . . .	.418
Belts, Seat . . . . .	.51	Brightness, Interior Lights . . . . .	.241
Bluetooth®		Bulb Replacement . . . . .	.602
Connecting To A Particular Mobile Phone Or Audio Device After Pairing . . . . .	.172	Bulbs, Light . . . . .	.111
Connect Or Disconnect Link Between the Uconnect® Phone And Mobile Phone . . . . .	.187	Camera, Rear . . . . .	.269
		Capacities, Antifreeze (Engine Coolant) . . . . .	.607

Capacities, Fluid . . . . .	.607	Clean Air Gasoline . . . . .	.493
Caps, Filler		Cleaning	
Fuel . . . . .	.497	Wheels . . . . .	.591
Oil (Engine) . . . . .	.558	Climate Control . . . . .	.388
Radiator (Coolant Pressure) . . . . .	.581	Clock . . . . .	.366
Carbon Monoxide Warning . . . . .	.108	Clutch . . . . .	.584
Cargo Area Features . . . . .	.295	Clutch Fluid . . . . .	.584
Cargo Compartment . . . . .	.295	Coin Holder . . . . .	.291
Car Washes . . . . .	.589	Compact Disc (CD) Maintenance . . . . .	.387
CD (Compact Disc) Player . . . . .	.377	Compact Disc (CD) Player . . . . .	.377
Cellular Phone . . . . .	.133	Compact Spare Tire . . . . .	.475
Chains, Tire . . . . .	.480	Computer, Trip/Travel . . . . .	.328
Changing A Flat Tire . . . . .	.532	Connector	
Chart, Tire Sizing . . . . .	.460	UCI . . . . .	.378
Check Engine Light (Malfunction Indicator Light) . . . . .	.318	Universal Consumer Interface (UCI) . . . . .	.378
Checking Your Vehicle For Safety . . . . .	.107	Console, Floor . . . . .	.291
Checks, Safety . . . . .	.107	Console, Overhead . . . . .	.271
Child Restraint . . . . .	.84	Contract, Service . . . . .	.623
Child Safety Locks . . . . .	.35	Coolant (Antifreeze) . . . . .	.607

Coolant Pressure Cap (Radiator Cap) . . . . .	.581	Daytime Running Lights . . . . .	.237
Cooling System. . . . .	.577	Dealer Service. . . . .	.563
Adding Coolant (Antifreeze) . . . . .	.579	Deck Lid, Emergency Release . . . . .	.46
Coolant Level . . . . .	.578	Deck Lid, Power Release . . . . .	.45
Disposal of Used Coolant . . . . .	.582	Defroster, Rear Window. . . . .	.299
Drain, Flush, and Refill . . . . .	.578	Defroster, Windshield . . . . .	.109
Inspection . . . . .	.582	Delay (Intermittent) Wipers . . . . .	.244
Points to Remember . . . . .	.582	Diagnostic System, Onboard . . . . .	.560
Pressure Cap . . . . .	.581	Dimmer Switch, Headlight. . . . .	.240
Radiator Cap . . . . .	.581	Dipsticks	
Selection of Coolant (Antifreeze) . . . . .	.578	Automatic Transmission . . . . .	.587
Corrosion Protection . . . . .	.588	Disposal	
Cruise Light . . . . .	.320	Antifreeze (Engine Coolant) . . . . .	.582
Cupholders . . . . .	.290	Door Locks . . . . .	.32
Customer Assistance . . . . .	.621	Door Locks, Automatic . . . . .	.34
		Door Opener, Garage. . . . .	.273
Data Recorder, Event . . . . .	.83	Driver's Seat Back Tilt . . . . .	.223
Daytime Brightness, Interior Lights. . . . .	.243		

Driving		Emergency, In Case of	
Through Flowing, Rising, or Shallow Standing		Freeing Vehicle When Stuck . . . . .	.548
Water . . . . .	.441	Hazard Warning Flasher . . . . .	.519
Electrical Power Outlets . . . . .	.286	Jacking . . . . .	.532
Electric Rear Window Defrost . . . . .	.299	Jump Starting . . . . .	.544
Electric Remote Mirrors . . . . .	.122	Overheating . . . . .	.519
Electronic Brake Control System . . . . .	.446	Towing . . . . .	.552
Brake Assist System . . . . .	.449	Emergency Trunk Release . . . . .	.46
Electronic Stability Program . . . . .	.455	Emission Control System Maintenance . . . . .	.561
Traction Control System . . . . .	.450	Engine . . . . .	.558
Electronic Roll Mitigation (ERM) . . . . .	.450	Air Cleaner . . . . .	.567
Electronic Speed Control (Cruise Control) . . . . .	.251	Block Heater . . . . .	.412
Electronic Stability Program (ESP) . . . . .	.455	Break-In Recommendations . . . . .	.106
Electronic Vehicle Information Center (EVIC) . . . . .	.269	Checking Oil Level . . . . .	.564
Emergency Brake . . . . .	.442	Compartment . . . . .	.557
Emergency Deck Lid Release . . . . .	.46	Cooling . . . . .	.577
		Exhaust Gas Caution . . . . .	.108
		Fuel Requirements . . . . .	.492
		Jump Starting . . . . .	.544

Oil . . . . .	.564	Automatic Transmission . . . . .	.588
Oil Filler Cap . . . . .	.558	Engine Oil . . . . .	.567
Oil Selection . . . . .	.565	Engine Oil Disposal . . . . .	.566
Overheating . . . . .	.519	Flashers	
Temperature Gauge . . . . .	.310	Hazard Warning . . . . .	.519
Enhanced Accident Response Feature . . . . .	.80	Turn Signal . . . . .	.111
Entry System, Illuminated . . . . .	.23	Flash-To-Pass . . . . .	.240
Ethanol . . . . .	.493	Flooded Engine Starting. . . . .	.411
Event Data Recorder . . . . .	.83	Floor Console . . . . .	.291
Exhaust Gas Caution. . . . .	.108	Fluid, Brake . . . . .	.610
Exhaust System. . . . .	.108	Fluid Capacities . . . . .	.607
Exterior Folding Mirrors . . . . .	.121	Fluid Leaks. . . . .	.111
Exterior Lighting. . . . .	.234	Fluid Level Checks	
Exterior Lights . . . . .	.111	Automatic Transmission . . . . .	.587
Filler Location Fuel . . . . .	.316	Fluids, Lubricants and Genuine Parts . . . . .	.608
Filters		Fog Lights . . . . .	.238
Air Cleaner . . . . .	.567	Folding Rear Seat . . . . .	.229
Air Conditioning . . . . .	.402	Freeing A Stuck Vehicle . . . . .	.548

Fuel . . . . .	.492	Fuses . . . . .	.595
Adding . . . . .	.497	Garage Door Opener (HomeLink®) . . . . .	.273
Additives . . . . .	.495	Gas Cap (Fuel Filler Cap) . . . . .	.497
Capacity . . . . .	.607	Gasoline, Clean Air . . . . .	.493
Clean Air . . . . .	.493	Gasoline (Fuel) . . . . .	.492
Ethanol . . . . .	.493	Gasoline, Reformulated . . . . .	.493
Filler Cap (Gas Cap) . . . . .	.497	Gauges	
Filler Door (Gas Cap) . . . . .	.316	Coolant Temperature . . . . .	.310
Gasoline . . . . .	.492	Fuel . . . . .	.314
Gauge . . . . .	.314	Speedometer . . . . .	.314
Light . . . . .	.316	Tachometer . . . . .	.308
Materials Added . . . . .	.495	Gear Ranges . . . . .	.413
Methanol . . . . .	.493	Gear Select Lever Override . . . . .	.550
Octane Rating . . . . .	.492	General Information . . . . .	.163
Requirements . . . . .	.492	Glass Cleaning . . . . .	.593
Tank Capacity . . . . .	.607	Gross Axle Weight Rating . . . . .	.503
Fueling . . . . .	.497	Gross Vehicle Weight Rating . . . . .	.501
Fuel System Caution . . . . .	.498		

GVWR . . . . .	.501	Heated Seats . . . . .	.224
Hands-Free Phone (Uconnect®) . . . . .	.133	Heater . . . . .	.388
Hazard		Heater, Engine Block . . . . .	.412
Driving Through Flowing, Rising, or Shallow		High Beam/Low Beam Select (Dimmer) Switch . . . . .	.240
Standing Water . . . . .	.441	Hill Start Assist . . . . .	.452
Hazard Warning Flasher . . . . .	.519	Hitches	
Headlights		Trailer Towing . . . . .	.505
Automatic . . . . .	.235	Holder, Coin . . . . .	.291
Cleaning . . . . .	.593	HomeLink® (Garage Door Opener) . . . . .	.273
Delay . . . . .	.235	Ignition	
High Beam/Low Beam Select Switch . . . . .	.240	Key . . . . .	.12
Lights On Reminder . . . . .	.237	Illuminated Entry . . . . .	.23
On With Wipers . . . . .	.235	Immobilizer (Sentry Key) . . . . .	.19
Passing . . . . .	.240	Infant Restraint . . . . .	.84
Switch . . . . .	.234	Information Center, Vehicle . . . . .	.321
Time Delay . . . . .	.235	Inside Rearview Mirror . . . . .	.119
Head Restraints . . . . .	.227	Instrument Cluster . . . . .	.305
Heated Mirrors . . . . .	.122	Instrument Panel and Controls . . . . .	.304

Instrument Panel Lens Cleaning . . . . .	.594	Keys . . . . .	.12
Interior Appearance Care . . . . .	.592	Key, Sentry (Immobilizer) . . . . .	.19
Interior Lights . . . . .	.241	Knee Bolster . . . . .	.61
Intermittent Wipers (Delay Wipers) . . . . .	.244	Lane Change and Turn Signals . . . . .	.239
Introduction . . . . .	.4	Lane Change Assist . . . . .	.239
iPod®/USB/MP3 Control		Lap/Shoulder Belts . . . . .	.51
Bluetooth® Streaming Audio . . . . .	.171	Latches . . . . .	.111
Jacking Instructions . . . . .	.535	Latch Plate . . . . .	.53
Jack Location . . . . .	.533	Lead Free Gasoline . . . . .	.492
Jack Operation . . . . .	.532	Leaks, Fluid . . . . .	.111
Jump Starting . . . . .	.544	Life of Tires . . . . .	.478
Key-In Reminder . . . . .	.17	Light Bulbs . . . . .	.111
Keyless Enter-N-Go . . . . .	.36	Lights . . . . .	.111
Keyless Entry System . . . . .	.24	Airbag . . . . .	.68
Keyless Go . . . . .	.15	Alarm . . . . .	.316
Key, Programming . . . . .	.20	Anti-Lock . . . . .	.318
Key, Replacement . . . . .	.20	Automatic Headlights . . . . .	.235
		Brake Warning . . . . .	.313



Bulb Replacement . . . . .	.603	License . . . . .	.606
Cruise . . . . .	.320	Lights On Reminder . . . . .	.237
Daytime Running . . . . .	.237	Low Fuel . . . . .	.316
Dimmer Switch, Headlight . . . . .	.238	Malfunction Indicator (Check Engine) . . . . .	.318
Electronic Stability Program (ESP) Indicator . . . . .	.458	Oil Pressure . . . . .	.317
Exterior . . . . .	.111	Parade Mode (Daytime Brightness) . . . . .	.243
Fog . . . . .	.238	Passing . . . . .	.240
Hazard Warning Flasher . . . . .	.519	Reading . . . . .	.240
Headlights . . . . .	.234	Seat Belt Reminder . . . . .	.312
Headlights On Reminder . . . . .	.237	Security Alarm . . . . .	.316
Headlights On With Wipers . . . . .	.235	Service . . . . .	.603
Headlight Switch . . . . .	.234	Service Engine Soon (Malfunction Indicator) . . . . .	.318
High Beam . . . . .	.240	SmartBeams . . . . .	.236
High Beam Indicator . . . . .	.312	Tire Pressure Monitoring (TPMS) . . . . .	.308
High Beam/Low Beam Select . . . . .	.240	Traction Control . . . . .	.458
Illuminated Entry . . . . .	.23	Turn Signal . . . . .	.111
Instrument Cluster . . . . .	.234	Vanity Mirror . . . . .	.123
Intensity Control . . . . .	.241	Voltage . . . . .	.317
Interior . . . . .	.241	Warning (Instrument Cluster Description) . . . . .	.308

Loading Vehicle . . . . .	.500	Frequency of Fluid Change . . . . .	.588
Capacities . . . . .	.502	Lubricant Selection . . . . .	.588
Tires . . . . .	.464	Shift Speeds . . . . .	.413
Locks . . . . .	.32	Master Cylinder (Brakes) . . . . .	.584
Automatic Door . . . . .	.34	Methanol . . . . .	.493
Auto Unlock . . . . .	.34	Mini-Trip Computer . . . . .	.328
Child Protection . . . . .	.35	Mirrors . . . . .	.119
Door . . . . .	.32	Automatic Dimming . . . . .	.119
Power Door . . . . .	.33	Electric Powered . . . . .	.122
Lubrication, Body . . . . .	.573	Electric Remote . . . . .	.122
Lug Nuts . . . . .	.520	Exterior Folding . . . . .	.121
		Heated . . . . .	.122
Maintenance Free Battery . . . . .	.568	Outside . . . . .	.120
Maintenance Procedures . . . . .	.563	Rearview . . . . .	.119
Maintenance Schedule . . . . .	.612	Vanity . . . . .	.123
Malfunction Indicator Light (Check Engine). . . . .	.318	Modifications/Alterations, Vehicle . . . . .	.7
Manual, Service . . . . .	.626	Monitor, Tire Pressure System . . . . .	.483
Manual Transmission . . . . .	.412	Mopar Parts . . . . .	.562
Fluid Level Check . . . . .	.588	MTBE/ETBE . . . . .	.493

Multi-Function Control Lever . . . . .	.238	Viscosity . . . . .	.566
New Vehicle Break-In Period . . . . .	.106	Oil Filter, Selection . . . . .	.567
Occupant Restraints . . . . .	.47	Onboard Diagnostic System . . . . .	.560
Occupant Restraints (Sedan) . . . . .	.65	Opener, Garage Door (HomeLink®) . . . . .	.273
Octane Rating, Gasoline (Fuel) . . . . .	.492	Operating Precautions . . . . .	.560
Odometer . . . . .	.316	Operator Manual (Owner's Manual) . . . . .	.4
Oil Change Indicator . . . . .	.317	Outside Rearview Mirrors . . . . .	.120
Oil Change Indicator, Reset . . . . .	.317	Overhead Console . . . . .	.271
Oil, Engine . . . . .	.564	Overheating, Engine . . . . .	.310
Capacity . . . . .	.607	Owner's Manual (Operator Manual) . . . . .	.4
Change Interval . . . . .	.565	Paint Care . . . . .	.588
Checking . . . . .	.564	Panic Alarm . . . . .	.26
Disposal . . . . .	.566	Parking Brake . . . . .	.442
Filter . . . . .	.567	Parking On Hill . . . . .	.442
Filter Disposal . . . . .	.566	ParkSense System, Rear . . . . .	.255
Materials Added to . . . . .	.566	Passing Light . . . . .	.240
Recommendation . . . . .	.565	Pets . . . . .	.106
		Phone, Cellular . . . . .	.133

Phone, Hands-Free (Uconnect®) . . . . .	.133	Radio Operation . . . . .	.387
Phone (Pairing). . . . .	.170	Rain Sensitive Wiper System . . . . .	.246
Placard, Tire and Loading Information . . . . .	.465	Rear Camera . . . . .	.269
Power		Rear Cupholder . . . . .	.290
Deck Lid Release . . . . .	.45	Rear ParkSense System . . . . .	.255
Door Locks . . . . .	.33	Rear Seat, Folding. . . . .	.229
Mirrors . . . . .	.122	Rear Window Defroster . . . . .	.299
Outlet (Auxiliary Electrical Outlet) . . . . .	.286	Rear Window Features . . . . .	.299
Sunroof . . . . .	.282	Recorder, Event Data . . . . .	.83
Windows . . . . .	.41	Recreational Towing . . . . .	.515
Power Steering Fluid. . . . .	.610	Reformulated Gasoline . . . . .	.493
Pregnant Women and Seat Belts. . . . .	.60	Refrigerant. . . . .	.570
Preparation for Jacking . . . . .	.534	Reminder, Lights On. . . . .	.237
Pretensioners		Reminder, Seat Belt. . . . .	.59
Seat Belts . . . . .	.59	Remote Control	
Programming Transmitters (Remote Keyless Entry) . . . . .	.24	Starting System . . . . .	.28
Radial Ply Tires . . . . .	.472	Remote Keyless Entry (RKE) . . . . .	.24
Radiator Cap (Coolant Pressure Cap) . . . . .	.581	Remote Sound System (Radio) Controls . . . . .	.385
		Remote Starting System. . . . .	.28

Remote Trunk Release . . . . .	.45	Schedule, Maintenance . . . . .	.612
Replacement Bulbs . . . . .	.602	Seat Belt Maintenance . . . . .	.594
Replacement Keys . . . . .	.20	Seat Belt Reminder . . . . .	.59
Replacement Parts . . . . .	.562	Seat Belts . . . . .	.47
Replacement Tires . . . . .	.479	Adjustable Upper Shoulder Anchorage . . . . .	.56
Reporting Safety Defects . . . . .	.625	And Pregnant Women . . . . .	.60
Resetting Oil Change Indicator . . . . .	.317	Child Restraint . . . . .	.84
Restraint, Head . . . . .	.227	Extender . . . . .	.61
Restraints, Child . . . . .	.84	Front Seat . . . . .	.51
Restraints, Occupant . . . . .	.47	Inspection . . . . .	.109
Rocking Vehicle When Stuck . . . . .	.548	Operating Instructions . . . . .	.52
Rotation, Tires . . . . .	.482	Pretensioners . . . . .	.59
		Rear Seat . . . . .	.51
Safety Checks Inside Vehicle . . . . .	.109	Untwisting Procedure . . . . .	.56
Safety Checks Outside Vehicle . . . . .	.111	Seats . . . . .	.219
Safety Defects, Reporting . . . . .	.625	Adjustment . . . . .	.219
Safety, Exhaust Gas . . . . .	.108	Heated . . . . .	.224
Safety Information, Tire . . . . .	.458	Rear Folding . . . . .	.229
Safety Tips . . . . .	.107	Seatback Release . . . . .	.223

Tilting . . . . .	.223	Signals, Turn. . . . .	.111
Security Alarm . . . . .	.21	SmartBeams . . . . .	.236
Selection of Oil . . . . .	.565	Snow Chains (Tire Chains). . . . .	.480
Sentry Key (Immobilizer) . . . . .	.19	Snow Tires . . . . .	.473
Sentry Key Programming . . . . .	.20	Spare Tire. . . . .	.475
Sentry Key Replacement . . . . .	.20	Specifications	
Service Assistance . . . . .	.621	Oil . . . . .	.565
Service Contract . . . . .	.623	Speed Control (Cruise Control). . . . .	.251
Service Engine Soon Light (Malfunction Indicator) . . . . .	.318	Speedometer. . . . .	.314
Service Manuals . . . . .	.626	Starting . . . . .	.28
Setting the Clock. . . . .	.366	Automatic Transmission . . . . .	.408
Shifting		Engine Fails to Start . . . . .	.411
Manual Transmission . . . . .	.412	Manual Transmission . . . . .	.407
Shift Lever Override . . . . .	.550	Remote . . . . .	.28
Short Message Service (SMS) . . . . .	.161	Starting Procedures . . . . .	.407
Shoulder Belts . . . . .	.51	Steering	
Shoulder Belt Upper Anchorage. . . . .	.56	Column Controls . . . . .	.238
Side Airbag . . . . .	.78	Column Lock . . . . .	.248
Side View Mirror Adjustment. . . . .	.120	Tilt Column . . . . .	.248

Wheel, Heated . . . . .	.249	Tilt Steering Column . . . . .	.248
Wheel, Tilt . . . . .	.248	Time Delay, Headlight . . . . .	.235
Steering Wheel Audio Controls . . . . .	.385	Tire and Loading Information Placard . . . . .	.464
Steering Wheel Mounted Sound System Controls . . . . .	.385	TIREFIT . . . . .	.523
Storage . . . . .	.601	Tire Markings . . . . .	.458
Storage, Vehicle . . . . .	.401	Tire Rotation . . . . .	.568
Stuck, Freeing . . . . .	.548	Tires . . . . .	.111
Sunglasses Storage . . . . .	.272	Aging (Life of Tires) . . . . .	.478
Sun Roof . . . . .	.282	Air Pressure . . . . .	.469
Sun Visor Extension . . . . .	.123	Chains . . . . .	.480
Supplemental Restraint System - Airbag . . . . .	.61	Changing . . . . .	.532
Sway Control, Trailer . . . . .	.451	Compact Spare . . . . .	.475
System, Remote Starting . . . . .	.28	General Information . . . . .	.469
		High Speed . . . . .	.472
Tachometer . . . . .	.308	Inflation Pressures . . . . .	.470
Telescoping Steering Column . . . . .	.248	Jacking . . . . .	.532
Temperature Control, Automatic (ATC) . . . . .	.399	Life of Tires . . . . .	.478
Temperature Gauge, Engine Coolant . . . . .	.310	Load Capacity . . . . .	.464
Text Messaging . . . . .	.161	Pressure Monitor System (TPMS) . . . . .	.483

Pressure Warning Light . . . . .	.308	Weight . . . . .	.506
Quality Grading . . . . .	.627	Towing Assistance. . . . .	.147
Radial . . . . .	.472	Traction . . . . .	.440
Replacement . . . . .	.479	Traction Control . . . . .	.450
Rotation . . . . .	.482	Trailer Sway Control (TSC) . . . . .	.451
Safety . . . . .	.458	Trailer Towing . . . . .	.502
Sizes . . . . .	.460	Cooling System Tips . . . . .	.514
Snow Tires . . . . .	.473	Hitches . . . . .	.505
Spare Tire . . . . .	.533	Minimum Requirements . . . . .	.508
Spinning . . . . .	.477	Trailer and Tongue Weight . . . . .	.507
Tread Wear Indicators . . . . .	.478	Wiring . . . . .	.511
Tire Safety Information . . . . .	.458	Trailer Towing Guide. . . . .	.506
Tongue Weight/Trailer Weight . . . . .	.507	Trailer Weight. . . . .	.506
To Open Hood . . . . .	.231	Transmission	
Towing . . . . .	.502	Automatic . . . . .	.416
24-Hour Towing Assistance . . . . .	.147	Filter . . . . .	.588
Disabled Vehicle . . . . .	.552	Maintenance . . . . .	.586
Guide . . . . .	.506	Manual . . . . .	.412
Recreational . . . . .	.515	Transmitter Battery Service (Remote Keyless Entry) . .27	



- Transmitter, Garage Door Opener (HomeLink®) . . . . .273
- Transmitter Programming (Remote Keyless Entry) . . .24
- Transmitter, Remote Keyless Entry (RKE) . . . . .24
- Transporting Pets . . . . .106
- Tread Wear Indicators . . . . .478
- Trip Odometer . . . . .316
- Trunk Lid (Deck Lid) . . . . .45
- Trunk Release, Emergency . . . . .46
- Trunk Release Remote Control . . . . .45
- Turn Signals . . . . .239
  
- UCI Connector . . . . .378
- Uconnect®
  - Advanced Phone Connectivity . . . . .150
  - Phone Call Features . . . . .178
  - Phone Features . . . . .145
- Uconnect® 130 With Satellite Radio
  - Playing MP3 Files . . . . .373
- Uconnect® (Hands-Free Phone) . . . . .133
  
- Uniform Tire Quality Grades . . . . .627
- Universal Consumer Interface (UCI) Connector . . . .378
- Universal Transmitter . . . . .273
- Unleaded Gasoline . . . . .492
- Untwisting Procedure, Seat Belt . . . . .56
  
- Vanity Mirrors . . . . .123
- Vehicle Certification Label . . . . .500
- Vehicle Identification Number (VIN) . . . . .6
- Vehicle Loading . . . . .466
- Vehicle Modifications/Alterations . . . . .7
- Vehicle Security Alarm (Security Alarm) . . . . .21
- Vehicle Storage . . . . .401
- Voice Command
  - Commands . . . . .201
- Voice Recognition System (VR) . . . . .199
  
- Warning Flasher, Hazard . . . . .519
- Warning Lights (Instrument Cluster Description) . . .308

Warnings and Cautions . . . . .	.6	Windows . . . . .	.41
Warranty Information . . . . .	.624	Power . . . . .	.41
Washer		Windshield Defroster . . . . .	.109
Adding Fluid . . . . .	.574	Windshield Washers . . . . .	.243
Washers, Windshield . . . . .	.245	Windshield Wiper Blades . . . . .	.573
Washing Vehicle . . . . .	.589	Windshield Wipers . . . . .	.243
Water		Wiper Blade Replacement . . . . .	.573
Driving Through . . . . .	.441	Wipers, Intermittent . . . . .	.244
Wheel and Wheel Trim . . . . .	.591	Wipers, Rain Sensitive . . . . .	.246
Wheel and Wheel Trim Care . . . . .	.591		
Wind Buffeting . . . . .	.45		
Window Fogging . . . . .	.401		

## **INSTALLATION OF RADIO TRANSMITTING EQUIPMENT**

Special design considerations are incorporated into this vehicle's electronic system to provide immunity to radio frequency signals. Mobile two-way radios and telephone equipment must be installed properly by trained personnel. The following must be observed during installation.

The positive power connection should be made directly to the battery and fused as close to the battery as possible. The negative power connection should be made to body sheet metal adjacent to the negative battery connection. This connection should not be fused.

Antennas for two-way radios should be mounted on the roof or the rear area of the vehicle. Care should be used in mounting antennas with magnet bases. Magnets may affect the accuracy or operation of the compass on vehicles so equipped.

The antenna cable should be as short as practical and routed away from the vehicle wiring when possible. Use only fully shielded coaxial cable.

Carefully match the antenna and cable to the radio to ensure a low Standing Wave Ratio (SWR).

Mobile radio equipment with output power greater than normal may require special precautions.

All installations should be checked for possible interference between the communications equipment and the vehicle's electronic systems.



STICK WITH THE SPECIALISTS®

Chrysler Group LLC

14PFD41-126-AA



First Edition

Printed in U.S.A.