

FAUCETS & SHOWER ACCESSORIES

PLUMBING

L

In Section L: Fresh Water Line Filters Winterizing Pumps Faucet & Shower Sink & Drain Holding Tanks Drain Valves & Fittings Drain Hose Chemicals & Toilets

SPRAY AWAY FAMILY FROM D&W INC. AVAILABLE AT PHOENIX PRODUCTS



The spray away family available at Phoenix Products put a high pressure, concentrated water source within fast, easy reach and it require very little space.

Great for rinsing gear, cleaning fish, washing boats and vehicles, dousing campfires and many other chores that require higher water pressure than an external shower unit can provide.

SPRAY-AWAY HOT & COLD

- Hot and Cold outlet with quick connect.
- 5-1/2" square hole required for installation.
- Only 5-3/4" deep.

28738 "Spray-Port" Outlet Box with Latch Hot/Cold Valves, Quick Brass Connect #SA-HC-BTW 10



REPLACEMENT PARTS

28737 3-3/8" 2 handle faucet with Quick Connect fitting #P1403M-55QCI 10

28739 15' Coil Hose Assembly with brass insert for "Spray-Port" 10

20214 **NEW!** Quick connect adapter to hook up a standard thread garden hose #9-SA-PT-ADPT 1

CULLIGAN MODEL ISH-100 IN-LINE SHOWER FILTER



Designed to make a good shower even better, Culligan's in-line shower filter is perfect for the consumer who prefers his or her existing showerhead but has concerns about the water coming from that showerhead.

Model ISH-100 reduces: • Chlorine • Sulfur odor • Scale

28752 LS US only ISH-100 Shower Filter #01019101 6

28753 WHR-140 Replacement Cartridge #01019105 6

For outdoor showering and various cleaning tasks!

Cut-out dimensions:
11" W x
6" H x
6-1/2" D.

THETFORD EXTERIOR SHOWER BOX



- Mountable shower box for hot & cold water.
- Durable, impact resistant.
- UV stable, fade resistant.
- Stylish clear knobs.
- Key lock (supplied with 2 keys) to ensure security.
- Hand held shower head with long reaching 59" flexible vinyl hose.
- Convenient water saving on/off valve on showerhead.
- Built in bracket to hold showerhead.
- CSA and IAMPO approved.
- Packaged.
- Package dim. : 6"H x 9.5"W x 14.5"D, 3lbs.

28579 Exterior Shower Box #36765 1



ITC EXTERIOR SHOWERS

Smartly designed exterior shower features quality components in a stylish presentation within a compact box (10.5" w x 6" h x 4" d) that installs both vertically and horizontally for versatility. High-impact automotive grade ABS is temperature stable, UV & impact resistant and paintable with reinforced 8' CSA approved PVC hose. Featuring a key locked door and stainless steel hinge pins, this washdown is code compliant and CSA approved with a brass anti-siphon vacuum breaker. Polar White.

28345 Exterior Shower #97023-A-D 10



OXYGENICS® BODYSPA® SKINCARE™ SHOWER

Put jet engine power in your shower with this attractive hand-held shower head.

Patented technology increases oxygen content in your water and self-pressurizes for the best shower experience possible. Comfort control adjusts from soft to stimulating. No clogging guaranteed. Includes wand, 59" hose, wand holder, comfort regulator, washers, teflon tape and easy installation instructions. Limited lifetime warranty. Available in 2.5 gpm.

BodySpa® SkinCare™ Shower:

28550 Chrome #10123 6

28730 White #15123 6

STEARNS SUN SHOWER, 2 1/2 GALLON

For a refreshing, hot shower anywhere and anytime. Holds 2 1/2 gallons of fresh water. Made of non-toxic PVC material. Features a rugged nozzle, solar window, and sturdy handle for carrying and hanging. On a clear 70° day, Sun Shower will heat 60° water to 105° in three hours. Folds compactly for easy storage.

79446 Sun Shower #2000008501 12

PLASTIC BATH/TUB REPAIR KIT

2-part epoxy system self-contained in a mixing pouch with fiberglass patch, sandpaper and application brush. Permanently fixes holes and cracks up to 1" dia. in 20 minutes. No need to remove tanks, tubs or shower stalls. For all types of plastic and fiberglass. Almond/White color.

25422 Tub Repair Kit #002-90216 6





FULL TUBS WITHOUT SKIRT

Formed ABS tubs come with a 1" foam support pad to ensure proper drainage. Each tub has a molded slip-resistant bottom. Satin textured finish helps hide accidental surface scuffs. Three sided nailing flange provides simple installation. Rolled front apron gives tub a finished look. UPS-able (unless mentioned).



24" x 36" (PW=Parchment White, W=White):

- 27703 RH Drain, PW #B243650191 1
- 28359 RH Drain, White #B243650121 1
- 27704 LH Drain, PW #B243650291 1
- 28360 LH Drain, White #B243650221 1

24" x 40" (PW=Parchment White, W=White):

- 27705 RH Drain, PW #B244050191 1
- 28363 RH Drain, White #B244050121 1
- 27706 LH Drain, PW #B244050291 1
- 28364 LH Drain, White #B244050221 1



24" x 46" (PW=Parchment White, W=White):

- 27581 RH Drain, W #B244601121 1

STEP TUBS

24" x 36" (PW=Parchment White, W=White):

- 27699 RH Drain, PW #B243600191 1
- 28358 LH Drain, W #B243600221 1

24" x 40" (PW=Parchment White, W=White):

- 27701 RH Drain, PW #B244000191 1



PLASTIC SHOWER PAN

Formed ABS shower pans come with a 1" foam support pad to ensure proper drainage. Each pan has a molded slip-resistant bottom. Satin textured finish complements bath decor. Models with four nailing flanges can be installed in any position. UPS-able. Can also be used in Horse Trailers & Class A's.

THREE FLANGE, LEFT DRAIN AT 12" 24" X 32"



- 28668 White #B243210221 1

CORNER HEXAGON, CENTER DRAIN, WITH 8-1/2" FULL SKIRT, 34" X 34"



- 28448 White #B343414021 1

TUB SURROUNDS - 3-WALL

Formed ABS tub/shower surrounds. Soap dishes/bottle shelves conveniently designed into corner. Easy clean satin textured finish. 1-piece seamless construction installs easily with foam tape. No added trim pieces required. Rolled finished edges and 90-degree fitted corners like fine home bath decor. Specially designed bottom flange overlaps tub and shower pan mounting flanges, no caulk needed. Not UPS'able.

24" W x 36" L x 62" H Tub Surround:

- 27707 Parch. White #B366220091 1
- 28365 White #B366220021 1

24" W x 40" L x 62" H Tub Surround:

- 28446 Parch. White #B406220091 1
- 28447 White #B406220021 1

24" W x 46" L x 56" H Tub Surround:

- 28751 White #B465620021 1

HOW TO SPECIAL ORDER DUO-FORM BATH PRODUCTS

1. IDENTIFY PRODUCT:

Full Tub (1), Step/Seat Tub (2), Shower Pan (3), Wall Surround (4).

2. HOW TO ORDER TUBS AND SHOWER PANS

A- Facing front of tub, identify drain location: Left Rear (1), Center Rear (2), Right Rear (3), Left Center (4), Mid Center (5), Right Center (6), Left Front (7), Center Front (8), Right Front (9), Left Neo (10), Center Neo (11) or Right Neo (12).

B- Measure the tub or shower pan:

1. Measure "W" from back to outer front;
2. Measure "L" from left to right;
3. For Neo angle products measure "W" only (Measurement should be taken from top to surround).

4. IDENTIFY COLOR

White (W) or Parchment White (PW).

3. HOW TO ORDER WALL SURROUNDS

1. Measure "W" from back to front of outer edge;
2. Measure "L" from left to right;
3. Measure "H" from bottom of surround to top (Not from floor to top).

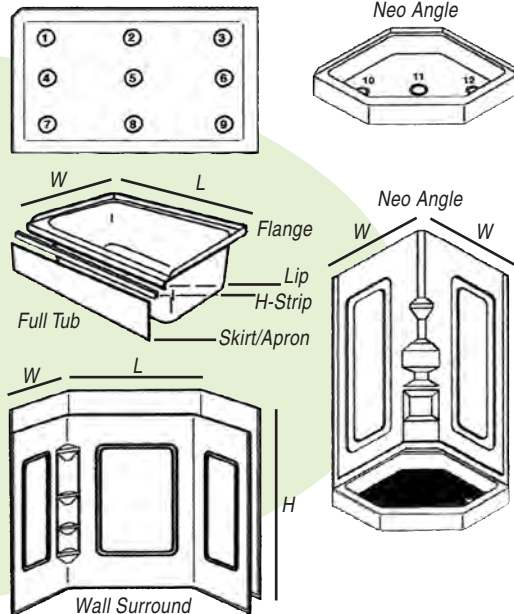

In Section L:	Fresh Water Line	Filters	Winterizing	Pumps	Faucet & Shower	Sink & Drain	Holding Tanks	Drain Valves & Fittings	Drain Hose	Chemicals & Toilets
---------------	------------------	---------	-------------	-------	-----------------	--------------	---------------	-------------------------	------------	---------------------

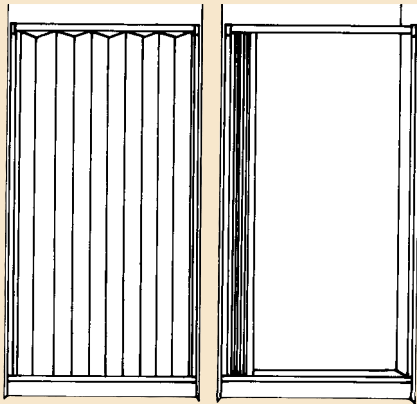

IRVINE SHADE & DOOR PLEATED SHOWER DOORS

Add privacy and beauty to your RV's living and sleeping areas with a quality Pleated Folding Door from Irvine Shade & Door. The finest materials and workmanship combine for top performance. Heavy-duty stain resistant fabric matches the color coordinated hardware for best looks. "Handlebar rail system" ensures smooth, easy operation. Quick installation in minutes.

Pleated Shower Door:

- 78380** 36 x 57, Ivory #3657SI 1
- 78381** 36 x 57, White #3657SW 1
- 78382** 48 x 57, Ivory #4857SI 1
- 78383** 48 x 57, White #4857SW 1
- 78384** 36 x 67, Ivory #3667SI 1
- 78385** 36 x 67, White #3667SW 1

JR PRODUCTS TUB STRAINER & DRAIN STOPPER

1-1/2" plastic strainer and stopper is a perfect replacement for any tub or sink. Replaces any 2" drain and comes with a new screw-in plastic stopper.



- 27641** Tub Strainer & Stopper, Pkg. #184030-A 1
- 27798** Replacement Drain Stopper, Pkg. #160-73-6-A 24

JR PRODUCTS SHOWER STRAINER WITH GRID

This 1-1/2" all purpose shower strainer is the perfect replacement for any area where a plug is not needed. The steel grid keeps items from entering your plumbing system and is easily cleaned. The grid is removable if access is needed to the plumbing.



- 27811** Strainer, Grid, Locknut & Rubber Washer, Pkg. #9495-209-022 18
- Fits up to a 2" drain opening. Made of die cast steel.
- 28547** Strainer, Grid, Locknut, Slipnut, Rubber Washer & Plastic Washer, pkg #9495-211-022 28

RV DESIGNER TUBMASTER ROLLER

Replacement roller for Tubmaster shower door.



- 28384** Tubmaster Rollers, CD/2 #H573 1



TUB STRAINER

2 1/2" metal tub strainer with stopper. Card of 1.

- 23286** Tub Strainer #33949020822 1



25653, 25046

BRISTOLITE 2 1/2" TWISTOP BASKET STRAINER

23084

Basket seats and seals at the twist of the wrist.

- 23084** Chrome Basket, Full Assembly, CD/1 #39117 25
- 25653** Plastic Crumb Cup, White, CD/2 #39105 1
- 25046** Plastic Crumb Cup, White #91500127 1

BRISTOLITE 2 1/2" TUB DRAIN WITH RUBBER STOPPER

Features rugged wrenching cross; installs easily without tools or sealing compound.



- 23082** Drain w/Stopper #65CAR227 1

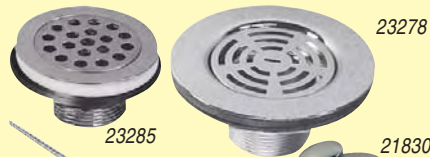

LASALLE BRISTOL STRAINERS

JR. SHOWER STRAINER

2 1/2" flat top strainer for sinks, showers and tubs. Metal. CD/1.

- 23285** Jr. Strainer #33949020922 1

SHOWER STRAINER

4 1/2" flat top strainer for showers and kitchen sinks. Metal.

- 23278** Shower Strainer #33R450LES 50

BATHTUB DRAIN

2 1/2" popstop bathtub drain with positive push-pull seal. Stopper seats and seals, at finger-tip touch; lifts easily to drain. Plug is completely removable for cleaning. Packaged with locknut.

- 21830** Bathtub Drain, CD/1 #39116 1

3 1/2" SINK STRAINER WITH BASKET

- 23279** Strainer with Basket #39166 25



SINK STOPPER

A quality stopper that really works to prevent water loss in RV sinks. Packaged.



Sink Stopper:

- 20027** Fits 1 5/8" Holes in Kitchen Sinks #01793 12
- 21683** Fits 1 1/4" Holes in Bathroom Basins #01794 24



JR PRODUCTS UNIVERSAL STRAINER WITH RUBBER STOPPER

1-1/2" strainer comes standard with a rubber stopper for a guaranteed seal every time. Made of die cast steel. Packaged.

- 27813** Strainer, Rubber Stopper, Locknut & Rubber Washer #9495-205-022 1
- 27814** Replacement 1-5/8" Rubber Stopper, Pkg. #6006-100 1



LASALLE BRISTOL SINKS



REVERE STAINLESS STEEL SINK LESS LEDGE



Revere Stainless Steel self rimming single bowl sink. Overall size: 17"x13"x5"; cut-out size: 16 1/2"x12 1/2". Drain 2 1/2".

28659 Single Sink #13RSM1713LL *g*



28657

REVERE STAINLESS STEEL DOUBLE SINK WITH LEDGE

Revere Stainless Steel self rimming double bowl sink. Drain 2 1/2".

28657 27"x16"x7"; Cut-out size: 26 1/4" x 15 1/4" #1317SSD27167 *40*

28658 25"x17"x5 1/2"; Cut-out size: 24 1/4" x 16 1/4" #1317SSD251735 *40*



28658

PLASTIC OVAL LAVATORIES

10" x 13" self-rim; 8" x 11" cutout. Comes with a glue-in tailpiece and a stopper.

21940 Bone #16156PP *g*

17" x 20". Without tailpiece; requires a 1-1/4" C.O. Plug (not included).

Oval Lavatory:

21780 White #16305PW *g*

21779 Ivory #16305PP *g*



21940

21780



The Original - Popular since 1972.



NEW!



Garden Hose Thread Terminal

ZEBRA RV ACCESSORIES COVERED BUCKET



HOLDING TANK FOR SINK AND BATH WASTE WATER

The Covered Bucket collapses into 2" x 10" x 10" for storage, yet holds more than 5 gallons (20 liters) of sink (grey) waste water. A positive shut-off valve prevents spills and the collapsible design means no venting is required. It comes with a 4 foot hose that attaches to your RV's male garden hose thread outlet. It is the least expensive model that meets all State and Campground Regulations for grey waste water disposal.

Packaged in a slim, shrink wrap package, a convenient hanging tab is provided for display hanging. Weighs less than 1 lb when empty.

20160 Covered Bucket, Grey Water Tank #R7701 *12*



LIFESAFE SUPER SEAL TAPE

Emergency repairs, stops leaks, forms solid rubber wrap. Strips clean, leaves no messy adhesive or residue. Holds 100psi at 220°F. Works wet or dry, greasy or dirty. Shrinks about 3% to form an airtight, waterproof seal. Use for outdoor plumbing, automotive hoses, broken water lines, electrical cables, garden hose repair, boat and RV repair, wire bundles, extension cord connectors, sports equipment, tool grips, power tools and rope ends.

47900 Super Seal Tape, 1" x 16 ft. #RE3845ES *12*



20055



20084

VALTERRA SWIVEL 360° DRAIN CONNECTORS

90° DRAIN CONNECTOR

1-1/2" x 3/4" Drain Connector:

20055 *LS* Bulk #T01-0021 *25*

20081 Carded #T01-0091VP *25*

STRAIGHT DRAIN CONNECTOR

1-1/2" x 3/4" Straight Drain Connector:

20084 Carded #T01-0094VP *25*



JR PRODUCTS SINK STRAINER WITH THREADED BASKET



22162

20329

Drain strainer with easy-to-use threaded basket for kitchen and lavatory sinks. Basket makes a sure seal but can be loosened to drain the sink while keeping items from entering your drain. Fits up to a 2" opening. Die cast steel.

20329 Strainer, Basket, Rubber Washer & Locknut, Packaged #9490-215-022 *28*

22162 Strainer, Basket, Tail Flange, Slipnut, Locknut, Rubber Washer, Packaged #9490-217-022 *28*

Replacement Parts:

20330 Basket Only, Packaged #9491-300-062 *1*

27817 *LS* Tail Flange Gasket, Bulk #6021-100 *1*

27820 *LS* 1-1/2" Slip Nut, Bulk #9301-001-011 *1*

SINK & DRAIN ACCESSORIES

PLUMBING

L

In Section L: Fresh Water Line Filters Winterizing Pumps Faucet & Shower Sink & Drain Holding Tanks Drain Valves & Fittings Drain Hose Chemicals & Toilets

HENG'S INDUSTRIES STAINLESS STEEL SINKS

HENG'S®



DOUBLE SINKS STAINLESS STEEL (SELF-RIMMING) 5" DEPTH

- Self-Rimming. • Double Bowl.
- 300 Series Nickel-Chrome 22 gauge Stainless Steel.
- 11-5/8" x 14" cutout, 23" W x 15.75" L x 5" D.

28596 Double Sink
#SSD-2315-5-22 4



SINGLE SINK STAINLESS STEEL (SELF-RIMMING)

- Self-Rimming. • Single Bowl.
- 300 Series Nickel-Chrome 22 gauge Stainless Steel.
- 11-5/8" x 14" cutout, 13" W x 15" L x 5" D.

28591 Single Sink #SSS-1315-5-22 20



5" DEPTH

- Self-Rimming. • Double Bowl.
- 300 Series Nickel-Chrome 22 gauge Stainless Steel.
- 11-5/8" x 14" cutout, 25" W x 15" L x 5" D.

28594 Double Sink
#SSD-2515-5-22 6



7" DEPTH - DOUBLE SINK STAINLESS STEEL (SELF-RIMMING)

- Self-Rimming. • Double Bowl.
- 300 Series Nickel-Chrome 20 gauge Stainless Steel.
- 11-5/8" x 14" cutout, 27" W x 16" L x 7" D.

28593 Double Sink #SSD-2716-7 4



7" DEPTH - WITH BRILLIANT SATIN SANDED BOWL AND DECK FINISH

- Self-Rimming. • 3 Hole Double Bowl.
- 300 Series Nickel-Chrome 20 gauge Stainless Steel.
- 11-5/8" x 14" cutout, 33" W x 19" L x 7" D.

28595 7" Deep Sink
#SSD-33193-7 4

RECTORSEAL CEMENT

RECTORSEAL ABS CEMENT

For connecting ABS plastic pipe and fittings. Bonds ABS pipe and/or fittings only. Approved for potable water. Dauber-top cans. Black.



ABS Cement:

20277 4-Oz. #55441 24

20269 8-Oz. #55443 24

20802 Pint #55445 12

23363 Quart #55447 1

ALL PURPOSE CEMENT

For cementing PVC and/or CPVC to ABS. Dauber-top 4-oz. can.

21353 All Purpose Cement #55501 24

PVC CEMENT

For PVC Types I and II potable water, DWV and SW pipe and fittings up to Schedule 40 and up to 6" diameter. Dauber-top 4-oz. can.

23351 PVC Cement #55011 24



ZEBRA Accessories RV ACCESSORIES FLEX-DRAIN KIT

- 24" Non-kink tubing.
- Sink strainer included.
- Evacuation flange with cap & strap included.
- Gas trap included.
- Packaged.

20175 Polar White #RM1522P 12



LASALLE BRISTOL POPSTOP

Vanity drain. 1 1/4" x 5". One-piece chrome C.O. plug and stainless steel ring. Carded.

21832 Popstop Vanity Drain #39136 25

25654 Replacement Popstop Only, Chrome #39135 1



CAMCO FLEXIBLE CAMPER DRAIN

Complete rust proof drain system designed especially for campers and RVs. Drain trap is made of durable, chemical resistant polypropylene, evacuation flange is made of durable ABS construction with UV stabilizers. Includes 25' of 3/4" ID hose, Camper Drain Trap and Evacuation Flange.

28702 Flex Drain, Polar White #37420 6





LASALLE BRISTOL VENT CHEK

Vent Chek makes fixture replacement easier, solves the problem of concealing an unsightly vent pipe. Eliminates the vent stack cover at the fixture vent and the possibility of roof leaks. Permits normal drainage and prevents "P" trap siphonage. 1 1/2" MPT NOTE: Vent Chek does not eliminate the main vent stack.

21028 Vent Chek #74BPC67 1

LAVATORY DRAIN/TRAP PACK

Features popstop vanity drain and ABS P-Trap, plus poly gaskets for 1 1/4" and 1 1/2" pipe.



21795 Lavatory Drain/Trap Pack #652006CPS 1

SHOWER DRAIN/TRAP PACK

Complete with shower strainer and stainless grid, ABS P-Trap, swivel strainer adapter and locknut. Includes poly gaskets for 1 1/4" and 1 1/2" pipe.



21826 Shower Drain/Trap Pack #652010LP 1

BATHTUB DRAIN/TRAP PACK

Complete with chrome popstop bathtub drain, ABS P-Trap, swivel strainer adapter and locknut. Includes poly gaskets for 1 1/4" and 1 1/2" pipe.



21837 Bathtub Drain/Trap Pack #652010CPS 1



ABS CONTINUOUS WASTE

ABS continuous waste. Adjusts 12" to 16" in length.

Continuous Waste, CD/1:

21835 1 1/4" #39140 12

21836 1 1/2" #39144 15

23097 1 1/2" with 3/4" Dishwasher Spout #39145 12



'P' TRAP

ABS plastic with strainer adapter. Includes poly gas-kets for 1 1/4" and 1 1/2" pipe.

21834 P-Trap Assembly #652011P 1

1 1/2" 'P' TRAP

Black tubular P-trap, carded.



23094 1 1/2" Black P-Trap #39131 15



1 1/4" 'P' TRAP WITH UNION

1 1/4" P-Trap Hub x Hub #633210E 1



'P' TRAP WITH SOLVENT WELD JOINT

20864 1 1/2" Fitting, A=3 3/4", B=5 7/32", C=4", D=1 13/16", E=2 1/8" #633201 25



'P' TRAP WITH DOUBLE SEAL UNION

20870 1 1/2" Fitting, A=3 5/8", B=4 15/32", C=3 1/4", D=1 7/16", E=2" #633211N 25

20871 LS 2" Fitting, A=4 3/4", B=6 1/2", C=5 1/16", D=2 5/16", E=2 11/16" #633212E 25



TAIL PIECE ADAPTER

Tail Piece Adapter:

23135 1 1/2" #633211X 25

23136 1 1/2" x 1 1/4" #633211Y 25

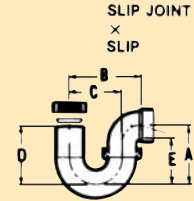

'P' TRAP WITH LA PATTERN

20873 1 1/4" Fitting, A=3 3/8", B=4 11/32", C=3 1/4", D=3 5/8", E=2" #633220A 1

21347 1 1/2" Fitting, A=3 5/8", B=4 15/32", C=3 1/4", D=3 1/4", E=3 5/8" #633221A 25

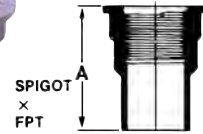

MALE STRAINER ADAPTER

20924 1 1/2" Male Strainer Adapter, A=3 3/8" #6332117 1

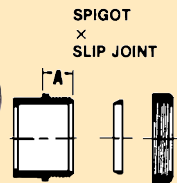

TRAP ADAPTER FITTING

20844 1 1/4" x 1 1/4" Adapter, A=1 5/16" Plastic Nut #632800A 25

20845 1 1/2" x 1 1/2" Adapter, A=1 5/16" Plastic Nut #632801A 25

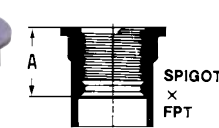

FEMALE STRAINER ADAPTER

20925 1 1/2", A=1 7/8" #6332119 1

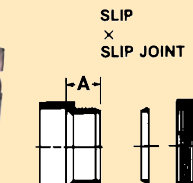

TRAP ADAPTER

20878 1 1/4" x 1 1/4" Adapter, A=3 1/32" Plastic Nut #632850A 25

20879 1 1/2" x 1 1/2" Adapter, A=3 1/32" Plastic Nut #632851A 1

20881 1 1/2" x 1 1/4" Adapter, A=1 11/16" Plastic Nut #632860A 25

ABS DRAIN FITTINGS

PLUMBING

L

In Section L: Fresh Water Line Filters Winterizing Pumps Faucet & Shower Sink & Drain Holding Tanks Drain Valves & Fittings Drain Hose Chemicals & Toilets



SWIVEL STRAINER ADAPTER ASSEMBLY (CONTINUOUS WASTE)

- 20981** 1 1/4" x 1 1/2" Adapter, SP x FPT #633214 1
- 23140** 1 1/2" Adapter, SP x FPT #633215 1
- 23141** 1 1/2" Adapter, EXT. SP x FPT #633216 1

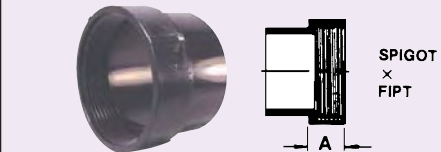

CLEANOUT ADAPTER FITTING

- 20895** 1 1/4", A=2 1/32" #633700 1
- 20896** 1 1/2", A=2 5/32" #633701 25
- 20897** LS 2", A=2 5/32" #633702 1
- 20898** 3", A=1 3/32" #633703 25

SLIP PLUG (SPIGOT)

- 21823** 1 1/2" Slip Plug #632075 1

ABS THREADED CAP

- 20813** 1 1/2" Threaded Cap Fitting, A=1 1/4" #633091 25

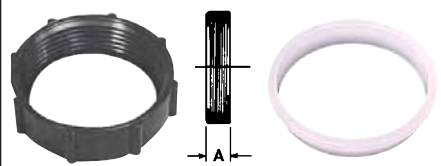

NUTS AND WASHERS

- Slip Joint Nut:
- 21542** 1 1/2", A=1 9/32" #633931 5
- Slip Joint Washer:
- 24222** 1 1/4" #349210003 1
 - 24223** 1 1/2" #65300 1
 - 24224** 1 1/2" x 1 1/4" #65301 1

THREADED CLEANOUT PLUG

- Threaded Cleanout Plug Fitting:
- 20815** 1 1/4", A=1" #633050 1
 - 20816** 1 1/2", A=1 3/8" #633051 25
 - 20819** 3", A=1 3/4" #633053 25

ABS SLIP COUPLINGS

- 20917** 1 1/4", A=1/8" #633000 1
- 20918** 1 1/2", A=1/8" #633001 1
- 20919** 2", A=1/8" #633002 1
- 20920** 3", A=3/16" #633003 48

1/4 BEND, VENT (90° ELBOW)

- 20838** 1 1/4", A=1" #632200 1
- 20839** 1 1/2", A=1 3/16" #632201 1
- 20840** 2", A=1 1/2" #632202 1
- 20841** 3", A=1 1/8" #632203 30

1/6 BEND (60° LONG ELBOW)

- 20829** 1 1/2" Elbow, A=1" #632601 1
- 20831** 3" Elbow, A=1 1/16" #632603 10

1/16 BEND (22 1/2° ELBOW)

- 20855** 1 1/2" Elbow, A=1/2" #632551 1
- 20856** 2" Elbow, A=1 1/16" #632552 1
- 20857** 3" Elbow, A=1 3/16" #632553 40

LONG SWEEP, 1/4 BEND (90° EXTRA LONG ELBOW)

- 20832** 1 1/4", A=2 1/4" #632275 1
- 20833** 1 1/2", A=2 3/4" #632276 1
- 20834** 2", A=3 1/4" #632277 1
- 20835** 3", A=4 1/16" #632278 20

1/8 BEND (45° LONG ELBOW)

- 21345** 1 1/4", A=1" #632500 1
- 20850** 1 1/2", A=1 1/8" #632501 1
- 20851** LS 2", A=1 1/2" #632502 1
- 20852** 3", A=1 3/4" #632503 25

1/4 BEND (90° LONG ELBOW)

- 20822** 1 1/4" Elbow, A=1 1/2", B=1 1/2" #632250 25
- 20823** 1 1/2" Elbow, A=1 3/4", B=1 3/4" #632251 25
- 20824** 2" Elbow, A=2 5/16", B=2 5/16" #632252 1
- 20826** 3" Elbow, A=3 1/16", B=3 1/16" #632253 30
- 20828** 3" Elbow, A=3 1/16", B=4 9/16", Slip x Thread #6322531 30

SINGLE SOCKET, 1/4 BEND (90° LONG STREET ELBOW)

- 21530** 1 1/4" Elbow, A=1 1/2", B=2 1/4" #632450 1
- 21531** 1 1/2" Elbow, A=1 3/4", B=2 1/2" #632451 1
- 21532** 2" Elbow, A=2 5/16", B=3 3/16" #632452 1
- 21533** 3" Elbow, A=3 1/16", B=4 9/16" #632453 25
- 21346** 3" Elbow, A=4 1/16", B=4 1/16" #635278 20

90° ELBOW SHORT TURN

- Hub x Thread.
- 21820** 3" x 3" Elbow, Short Turn #6322031 25

VENT TEE

- Slip x slip x slip.
- 20929** 1 1/2" All 3 Ends, A=2 3/8", B=1 13/16" #632101 1

3-WAY ELBOW

- 3-Way Elbow, Hub x Hub x Hub:
- 23128** 1 1/2" #632261 1
 - 23130** 3" #632263 10

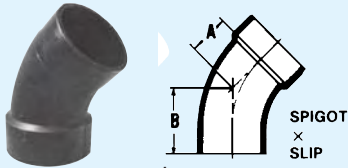

SINGLE SOCKET, 1/8 BEND (45° LONG STREET ELBOW)

- 21526** 1 1/4" Elbow, A=1", B=1 3/4" #632400 1
- 21527** 1 1/2" Elbow, A=1 1/8", B=1 7/8" #632401 1
- 21528** 2" Elbow, A=1 1/2", B=2 3/8" #632402 1
- 21529** 3" Elbow, A=1 3/4", B=3 1/4" #632403 25

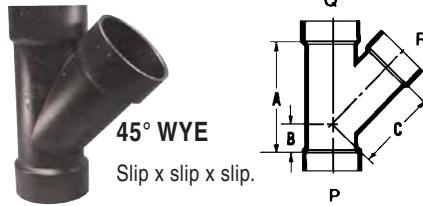

45° WYE

Slip x slip x slip.

- 20860** P=3" x Q=3" x R=1 1/2"; A=4 1/4", B=1/2", C=4 5/16" #632331 25



ABS ADAPTER

- Female Adapter:*
- 20890** 1 1/2", A=1" #632891 25
 - 20891** 2", A=1" #632892 1
 - 20892** 3", A=1 1/2" #632893 35
- Male Adapter:*
- 21816** 1 1/4" x 1 1/4" #632870 25
 - 21671** 1 1/2" x 1 1/2", A=1 1/32" #632871 1
 - 20886** 3" x 3", A=2" #632873 1



3" ABS THREADED NIPPLE

3" ABS Nipple, Threaded On Both Ends (TBE):

- 20067** 3" TBE #T3503 5
- 20068** 4" TBE #T3504 6
- 20069** 6" TBE #T3506 32
- 20070** 8" TBE #T3508 6

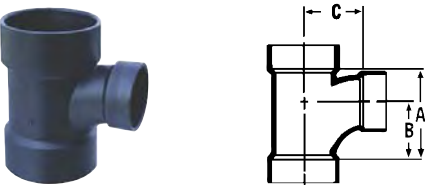

SANITARY TEE, REDUCING

- 20820** LS 3" x 3" x 2" Fitting, A=3 9/16", B=2 1/8", C=2 7/8" #632130 20
- 20821** 3" x 3" x 1 1/2" Fitting, A=2 11/16", B=1 3/4", C=2 9/16" #632131 20



PIPE INCREASER/REDUCER

- ABS Pipe Increaser:*
- 21348** 1 1/2" x 2", A=1 7/32" #633022 1
 - 21761** 1 1/2" x 3", A=7/8" #633023 25
 - 21349** 2" x 3", A=7/8" #633024 1

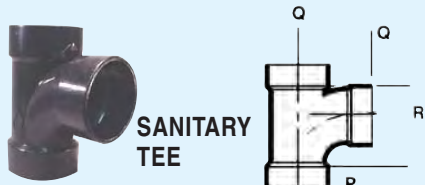

SANITARY TEE

s=Slip; h=Hub; fpt=Female Pipe Thread.

- 20901** 1 1/4" All 3 Ends, P-s, Q-s, R-s #632150 1
- 20902** 1 1/2" All 3 Ends, P-s, Q-s, R-s #632151 1
- 20903** LS 2" All 3 Ends, P-s, Q-s, R-s #632152 25
- 20904** 3" All 3 Ends, P-s, Q-s, R-s #632153 25

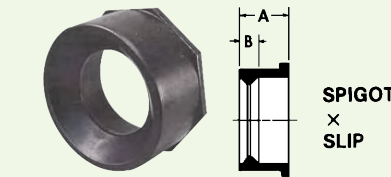

FLUSH BUSHINGS

- 21534** 1 1/2" x 1 1/4" Bushing, A=1 9/16", B=9/16" #632750 1
- 21535** 2" x 1 1/4" Bushing, A=1 1/16", B=5/16" #632760 1
- 21536** 2" x 1 1/2" Bushing, A=1 1/16", B=5/16" #632752 1
- 21537** 3" x 1 1/2" Bushing, A=1 3/4", B=1" #632762 1



90° ELBOW WITH HEEL OUTLET

Hub x Hub x Hub.

- 23126** 3" x 3" x 2" Short Turn #632245 25



SINGLE LONG TURN T-WYE

Single Long Turn T-Wye, Hub x Hub x Hub:

- 23149** 1 1/2" #634301 1
- 23151** 3" #634303 15

ABS PIPE-COMMON SIZES

ABS, Schedule 40. For all DW-V applications. IAPMO approved. 10 ft. lengths.

- ABS Pipe, 10 ft. L:*
- 21815** 1 1/4" #61C4510 ◆1
 - 20909** 1 1/2" #61C5010 ◆1
 - 20910** 2" #61C5510 ◆1
 - 20911** 3" #61C6510 ◆1



TEKNOR APEX AQUA DRAIN HOSE

For flushing out gray and black water tanks. Not for drinking water.

- AquaDrain Hose:*
- 28046** 5/8" x 25' #828VR-25 10



VALTERRA HOSES

RV FLUSHING HOSE

This hose is specifically made for waste water applications to connect gray water tanks to sewer inlet. Gray color eliminates confusion with fresh water hoses. Use with RV Hydroflush or other flushing applications.

- 1/2" Gray RV Flushing Hose:*
- 27281** 15' #W01-4180 6
 - 28008** 25' #W01-4300 10



TOTE TANK FILL HOSE

No more hassles with hard to reach hoses. 4' Tote Tank Filler Hose allows you to fill or drain your tote tanks quickly and easily. Gray color eliminates confusion with fresh water hoses.

- 27718** 1/2" x 4' Tote Tank Fill Hose #W01-4048 10



THETFORD'S IMPROVED SMARTTOTE™ PORTABLE WASTE TANKS

A premium portable waste tank that delivers the utmost in ease of use, convenience, sanitation and ease of storage. Thetford's innovative design brings it all together with patented hose handling and AutoStop™ fill shutoff to prevent spills.

- Saves time, effort, hassle!
- Completely self-contained; nothing else to buy.

PERMASTORE HOSE HANDLING & STOWAGE

Self-storing sewer hose stays connected at bottom of tank. Cradle pivots; hose extends 5 feet. Ingenious! No more mess or worry about where to stow the hose. A bayonet cap prevents spills. Just pull out and connect to fill or empty. Hose returns neatly into its cradle. The onboard water hose (all models except 12-gallon) provides easy cleanout, and friction-fits on the tank for convenient storage.

AUTOSTOP™ LEVEL GAUGE

There's no guessing with the AutoStop level gauge/valve. It monitors the fill level to prevent messy overflowing, and stops the flow when the tank is full. The gauge is removable for easy maintenance, and releasing its vacuum helps drain the contents at the bottom of the tank.

EASY HANDLING—NO HEAVY LIFTING

The LX models have 4 wheels. LX tanks remain horizontal throughout use, even when draining. The LX tow handle pivots for convenient transit, hooks to any ball hitch, and folds flat onto tank without disassembly for fast, easy storage.



IMPROVED for 2008!



- Saves time, effort, hassle
- PermaStore™ hose stays connected to tank; collapses into pivoting cradle for neat, compact storage
- AutoStop™ gauge prevents messy overflowing
- Molded tow handle on LX models folds flat
- Self-storing rinse hose on all models (except SmartTote 12)
- LX models have tow handle and 4 wheels for easy handling

SmartTote Premium Portable Waste Tank:

- 28491** SmartTote 12, 12-Gallon 2-Wheel Tank; 30" L x 18-1/8" W x 10-1/2" H (Equipped with 2 Wheels (5" Rear); Dump Cap (3" Bayonet); Cap for water inlet (receptacle retrofit-able to level gauge) #40505 1
- 28492** SmartTote 18LX, 18-Gallon 4-Wheel Tank with Handle; 34-1/8" L x 19-3/4" W x 14-3/8" H (Equipped with 4 Wheels; Tow Handle; 5' PermaStore™ Hose; AutoStop™ Level Gauge; Water Hose) #40510 6
- 28493** SmartTote 27LX, 27-Gallon 4-Wheel Tank with Handle; 39" L x 23-7/8" W x 14-3/8" H (Equipped with 4 Wheels; Tow Handle; 5' PermaStore™ Hose; AutoStop™ Level Gauge; Water Hose) #40515 6
- 28494** SmartTote 35LX, 35-Gallon 4-Wheel Tank with Handle; 47-5/8" L x 23-7/8" W x 14-3/8" H (Equipped with 4 Wheels; Tow Handle; 5' PermaStore™ Hose; AutoStop™ Level Gauge; Water Hose) #40520 4



Self-storing sewer hose stays connected; just remove the cap and pull out the hose.



Easy to connect hose for filling.



The hose cradle swivels down for draining without lifting the tank.



Self-storing water hose for easy tank cleaning.



AutoStop™ helps drain the remnants in the tank bottom.

THETFORD NON-FORMALDEHYDE STORAGE DEODORANT

Controls odors in stored RV holding tanks and tote tanks for up to six months! It's compatible with antifreeze, is non-formaldehyde and 100% biodegradable. The quality and reliability you expect from the makers of Aqua-Kem.

- Lubricates seals.
- Compatible with antifreeze.
- From the makers of Aqua-Kem.

Thetford Storage Deodorant (Not available in Canada):

- 28674** 24-oz. #32901 6
- 28673** 3 x 8-oz. bottle #32900 12



28674



28673



Tote-N-Stor

Portable Waste Transporters
5 Convenient Tote-N-Stor Sizes:
6, 11, 15, 25 & 32 Gallons

Tote-N-Stor Portable Waste Transporters provide you with the added waste water storage for those long stays without moving your RV.

Easy-to-carry
6-gallon
#25951

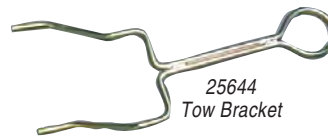
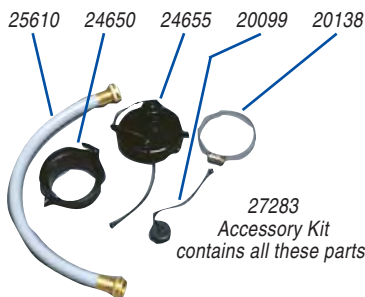

The 15, 25 and 32 gallon tanks come with 36" of 3" drain hose (28209), 1 hose clamp (20138) and a tow bracket (25644) as standard accessories.

The larger 15, 25 and 32 gallon models add capacity, along with the convenience of a storage compartment for those commonly needed fittings used to connect or drain your portable tank. These tanks can be used in conjunction with both gray and black water holding tanks.

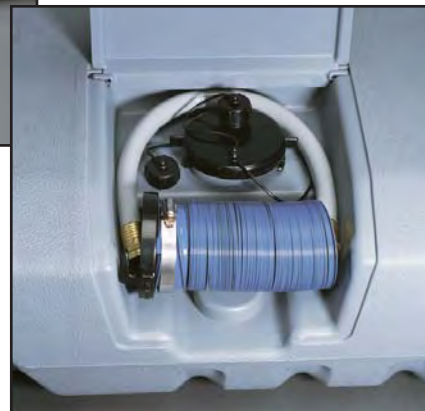

TOTE-N-STOR DRAIN WATER TANKS

PLUMBING

L

In Section L: Fresh Water Line Filters Winterizing Pumps Faucet & Shower Sink & Drain Holding Tanks Drain Valves & Fittings Drain Hose Chemicals & Toilets



27551

WITH QUIET RUBBER WHEELS!

Quality Constructed...Great Value!

Accessories stored in special storage compartment on 15, 25 & 32 gallon models. Accessories included: 15" garden hose, 3/4" gray water hook-up hose, garden hose cap, sewer hose adapter, 36" of 3" sewer hose, hose clamp and a tow bracket.

32-Gal. 25609



11-Gal. 25606



Take it away!
The 25644 Towing Bracket makes it easy to tote a full tank.

6 GALLON TOTE-N-STOR

Your basic Tote. Easy to carry, without wheels. 21" L x 13 1/2" W x 9"H.

25951 6 Gal. Tote-N-Stor #25951 1

11 GALLON TOTE-N-STOR

With wheels. 31 3/8" L x 15 1/2" W x 9"H

25606 11 Gal. Tote-N-Stor #25606 29

15 GALLON TOTE-N-STOR

With wheels and storage compartment and accessories. 31 1/4" L x 17 3/4" W x 11 5/8" H

25607 15 Gal. Tote-N-Stor #25607 20

25 GALLON TOTE-N-STOR

With wheels and storage compartment and accessories. 35 1/4" L x 24" W x 11 5/8" H

25608 25 Gal. Tote-N-Stor #25608 16

32 GALLON TOTE-N-STOR

With wheels and storage compartment and accessories. 45 3/4" L x 24" W x 11 5/8" H

25609 32 Gal. Tote-N-Stor #25609 16

Replacement Parts for Tote-N-Stor:

25610 15" Garden Hose #25610 10

20099 Garden Hose Cap & Strap #20099 100

24654 Standard Straight Hose Adapter, CD/1 #24654 30

24655 3" Cap with Garden Hose Fitting #24655 40

27282 Replacement Lid #27282 3

Accessories for Tote-N-Stor:

25644 Towing Bracket #25644 20

27283 Accessory Kit, Includes: **25610** (15" Garden Hose), **20099** (3/4-inch Cap & Strap), **24650** (Straight Hose Adapter), **20138** (Hose Clamp), and **24655** (Termination Cap) #27283 1

27551 Rubber Wheel Kit #43115 1

- Completely Assembled
- Rugged Construction
- Larger sizes include FREE Accessory Kit



ORIGINAL TOTE-ALONGS

BARKER ORIGINAL AND 4-WHEELER TOTE-ALONGS...

Five convenient sizes from 5 to 30 Gallons provide a capacity for every need. Blow-molded polyethylene construction and quality zinc plated steel brackets throughout. Extra large, heavy-duty wheels and standard bayonet fittings included on all tanks except 5 gallon size. Tow bracket and 5' sewer hose included with 15, 22, and 30 gallon Tote-Alongs. All original Tote-Alongs come completely assembled.

5-GALLON ORIGINAL TOTE-ALONG TANK

20" L x 12" W x 7" H; 6 lbs. empty.

26079 ^{LS} 5-Gallon Tank #10887 1

10-GALLON ORIGINAL TOTE-ALONG TANK

30" L x 15" W x 8 1/4" H; 11 lbs. empty.

26080 10-Gallon Tank #10893 1

15-GALLON ORIGINAL TOTE-ALONG TANK

37" L x 15" W x 10" H; 13 lbs. empty.

26082 15-Gallon Tank #11747 1

22-GALLON ORIGINAL TOTE-ALONG TANK

37" L x 20" W x 10" H; 16 lbs. empty.

26081 22-Gallon Tank #11104 1

30-GALLON TOTE-ALONG TANK

37" L x 24" W x 11" H; 34 lbs. empty.

Also includes 3/4" garden cap hose, 3" bayonet cap, two 3" hose adapters, two 3" stainless steel adjustable clamps, and 1/2" ID drain hose

28671 30-Gallon Tank #31342 1

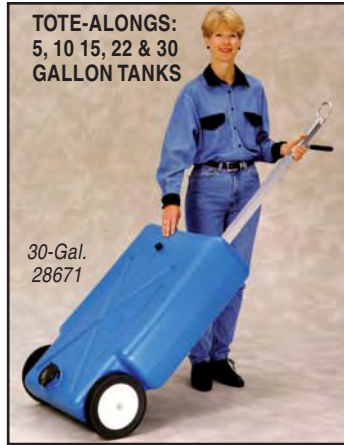

barker



4-Wheeler



16-GALLON 4-WHEELER TANK

37" L x 17" W x 11 1/2" H; 21 lbs. empty.

28094 16-Gallon 4-Wheeler #28191 1

25-GALLON 4-WHEELER TANK

38 L x 24" W x 11 1/2" H; 32 lbs. empty.

27659 25-Gallon 4-Wheeler #25895 1

32-GALLON 4-WHEELER TANK

46" L x 24" W x 11 1/2" H; 37 lbs. empty.

27660 32-Gallon 4-Wheeler #27844 1

42-GALLON 4-WHEELER TANK

46" L x 24" W x 14" H; 47 lbs. empty.

28479 42-Gallon 4-Wheeler #30844 1

TOTE-ALONG BOBBER GAUGE FULL TANK INDICATOR

Tote-Along Bobber Gauge alerts you before overfilling, helps prevent spills and mess. Installs in seconds and attaches to any 3/4" garden hose opening. The red tipped "bobber" provides a visual signal when your tank is almost full.



27661 Bobber Gauge #26835 1

GRAY WATER TANK SYSTEM

Collapsible 5-gallon tank for easy storage. Easy to carry handle for pouring water plus the three foot hose allows you to hook up to pop-up campers or any RV with 3/4" termination cap with male garden hose connection. Made in USA.

26001 gray WaterTank System #16018 1

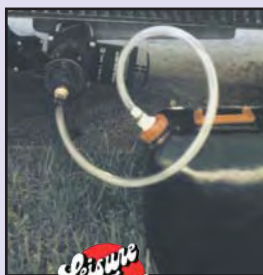

Collapsible

CAMCO REPLACEMENT SEWER FITTING GASKETS, BAYONET & 4 IN 1 ADAPTER

CAMCO

Replace the gaskets on your bayonet and 4 in 1 sewer fittings to ensure an odor tight seal. Gaskets work with all Camco, Revolution™, RhinoFLEX™, and EasySlip® elbow and bayonet fittings. 2 set pack includes two bayonet gaskets and two 4 in 1 gaskets.

20091 RV Sewer Hose Fitting Gaskets, 2 sets of gaskets #39834 1

