

In Section D: Meters/Testers Wiring Fuses 12V Accessories Battery Accessories Chargers & Inverters Cords & Adapters Box/Hatch Switches

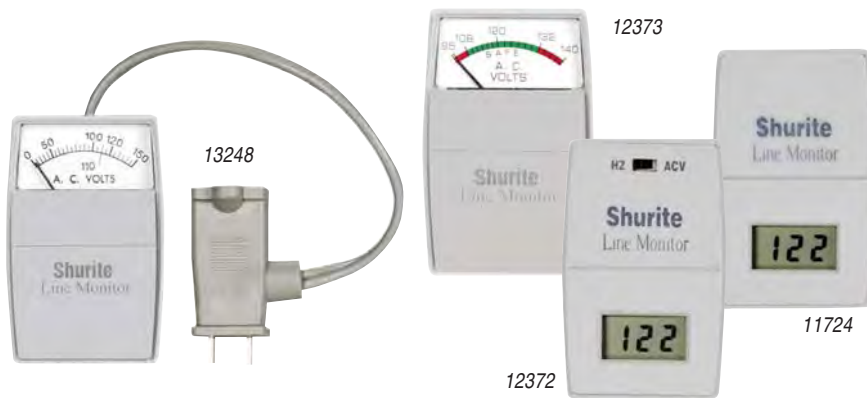

SHURITE POWER INTEGRITY SERIES LINE MONITORS

Compact line monitors designed for use by owners of RVs or boats to detect instability in their temporary power sources, whether park or shore power. By alerting you to power brown-outs or surges, sensitive equipment such as

compressors, appliances or electronics can be spared the damaging effects of power fluctuations outside the safe operating line voltage range of 108-132V AC. All units are designed to plug directly into any standard AC outlet. By evaluating the integrity of your power source, you can now protect sensitive equipment with these popular, inexpensive monitors. 2.10" x 3.25" x 1.20".



EAST PENN MANUFACTURING

* All East Penn wire & cable products are in compliance with the RoHS standards.

BATTERY AND STARTER CABLE*

- Made with flexible soft-annealed stranded copper wire. • 100% copper conductor.
- Temperature rating of 80°C/176°F @ 60V or less. • Meets SAE J1127.

11132 4-Gauge x 100 ft., Red #04608 1

BATTERY CABLES*

3 ft. lengths.



749637 2-Gauge 3 ft. Positive Cable #749637 25

749638 2-Gauge 3 ft. Negative Cable #749638 25

Order #	Mfr. #	Description	Range	Price
SHURITE ANALOG MONITORS				
13248	#79406LT	Line Voltage Tester with Thru-Plug. Plug cord into outlet and appliance into Thru-Plug. Sustained voltage drop of 5 volts indicates problem that should be investigated.	0-150 VAC	
12373	#80406LTS	Line Voltage Monitor with suppressed scale	90-140 VAC	
SHURITE DIGITAL MONITORS				
12372	#9016LFT	LS Line Voltage and Frequency Monitor, switchable between Voltage and Frequency	108-132 VAC 50-70 Hz	
11724	#9018LT	Line Voltage Monitor	108-132 VAC	

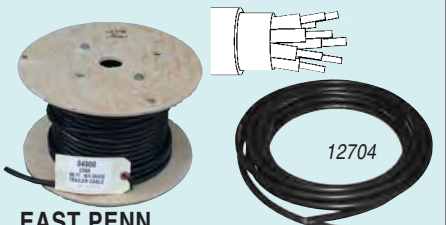

EAST PENN MANUFACTURING TRAILER CABLE*

Top-quality Trailer Cable insulated and PVC jacketed ensures flexibility at -40° C. The conductors are stranded copper, color coded to meet SAE specs, resist oil, grease and weather. Available in 4, 6 and 7 conductors. **12704** has 6 strands of 12-gauge and 1 strand of 10-gauge wire. • 100% copper conductor.

- Temperature rating of 80°C/176°F @ 60V or less. • Nominal low temperature of -40°C.
- Meets SAE J1127.

Trailer Cable:

- 12703** 16-4 x 100 ft. #04900 1
- 12702** 14-4 x 100 ft. #04904 1
- 10020** 14-6 x 100 ft. #04906 1
- 10737** 14-7 x 100 ft. #04908 1
- 12704** 12-6 and 10-1 x 100 ft. #04914 1



GOLDENEYE TWO-BATTERY ENERGY GAUGE

Easy-to-install, pre-wired battery gauge panel lets you measure the percent-of-charge in two battery installations. Ideal for monitoring a starting battery and auxiliary battery, or two independent auxiliary batteries. The gauge is internally lit for night-time use; includes complete instructions for do-it-yourself installation.

17810 Energy Gauge #55-6200 1

JT&T TEST LEADS WITH CLIPS

30" length, one red wire, one black wire.



11719 Pk/1 30" Lead with Clips #219F 6



JT&T ALLIGATOR CLIPS

Solder-type alligator clip with 3/8" jaw opening. Full meshing teeth. Cadmium-plated steel for long life. Sold in package of six.

11020 Alligator Clips #0218H 6

HEAVY DUTY ALLIGATOR CLIP



Heavy duty 30 amp alligator clip with 1/2" jaw opening. Solderless wire connection with strain relief. Chrome plated steel for long life.

38942 Alligator Clip #38942 1

ELECTRICAL TAPE

7-mil. black PVC tape is soft and flexible. UL listed. 3/4" x 60 ft.

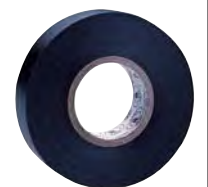

Electrical Tape, 3/4" x 60 ft.:

- 10686** Carded #CT410C 24
- 10090** Bulk #10090 10

* All East Penn wire & cable products are in compliance with the RoHS standards.



EAST PENN JACKETED WIRE*

Size 12-gauge recommended for electric brake wire. Duplex primary is made with two PVC insulated primary wires laid parallel and covered with a high-quality PVC jacket. The jacket provides a compact cable, oblong in shape, and protects the insulated conductors against weather and conditions. Standard gray jacket with two conductors, black & white.

- 100% copper conductor. • Temperature rating of 105°C/221°F @ 60V or less. • Nominal low temperature of -30°C. • Meets SAE J1127.

10025 14-2 x 100 ft. Jacketed Wire #03206 4

10026 12-2 x 100 ft. Jacketed Wire #03212 4

10181 12-2 x 1000' Brake Wire #03214 1



EAST PENN PARALLEL PRIMARY WIRE*

Conforms to SAE specifications and meets ATA standards. Conductors bonded together for ease in handling. All copper strand core with PVC coating. Manufactured to highest quality standards. 3-conductor wire standard colors: brown, yellow, green; 4-conductor wire standard colors: white, brown, yellow, green.

- 100% copper conductor. • Temperature rating of 80°C/176°F @ 60V or less. • Meets SAE J1128.

100 ft. Spools Wire:

10023 16-4 Gauge #02915 4

10024 14-4 Gauge #02906 4

1000 ft. Spools Wire:

10178 16-4 Gauge #02917 1

10179 14-4 Gauge #02908 1

7-WAY TRAILER LIGHTING CABLE*

Insulated 7-wire, color coded cable that includes one 12-Ga. blue wire, two 10 Ga. wires (black, white); and four 14 Ga. wires (red, brown, yellow, green).



15352 7-Conductor Multi-Ga. Wire, 100 ft. #04915 1

7-WAY TRAILER LIGHTING CABLE*

7 conductors, 14-gauge.

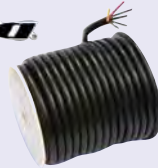

13091 14-7 Ga. Primary Wire, 250 ft. #99991 1



EAST PENN MANUFACTURING PRIMARY WIRE*

PVC insulated primary wire is standard for original equipment and replacement on automotive equipment. It is highly resistant to grease, oil and acids and is available in bright colors for easy identification.

- 100% copper conductor. • Temperature rating of 80C/176F @ 60V or less. • Meets SAE J1128.

100 FOOT SPOOLS COPPER PRIMARY WIRE

Wire Gauge	Yellow	Red	Black	White	Green	Blue	Brown	
8	—	11129	11130	11131	—	—	—	
10	—	11081	11082	11083	—	—	—	
12	—	11085	11086	11087	—	11089	—	
14	11091	11092	11093	11094	11095	11096	11097	
16	—	11099	—	—	11102	—	11104	

Denotes Limited Supply!

1000 FOOT SPOOLS COPPER PRIMARY WIRE

Wire Gauge	Yellow	Red	Black	White	Green	Blue	Brown	
10	—	11106	11107	11108	—	—	—	
12	—	11110	11111	11112	—	11113	—	
14	11115	11116	11117	11118	—	11120	11121	
16	11122	11123	11124	11125	11126	—	11128	



STAR BRITE LIQUID ELECTRICAL TAPE

Seals and protects electrical connections. Prevents corrosion on wires and terminals. Quick and easy to use; comes with applicator brush cap. Fast drying liquid tape is neater and more convenient than conventional electrical tape.



757505 Black #084104B 12



JT&T VINYL GROMMETS



Inexpensive, flexible, oil resistant, high dielectric vinyl with outstanding aging qualities.

10796 Pk/7 5/8" Grommets #4405H 6

11703 Pk/13 Assorted Sizes: 1/4", 5/16", 3/8" #4450H 6

11704 Pk/4 Assorted Sizes: 2 1/32", 7/8", 1" #4452H 6

11705 Pk/9 Assortment: 1/4", 5/16", 3/8", 9/16", 1/2", 5/8", 2 1/32", 7/8", 1" #4453H 6



JT&T SPECIALTY CONNECTORS (Pigtails)

SOFT VINYL WIRE CONNECTORS

Also sometimes called pigtails. Twist splices.

10318 Pk/100 18-12 Ga. Yellow Twist Splices #1222C PKG/100 6

JT&T SPADES

SOLDERLESS, FLARED, VINYL INSULATED



12-10 GA., YELLOW

10052 Pk/14 12-10 Gauge #10 Spade #2058H 1



JT&T PLUG/ RECEPTACLES DISCONNECT TERMINALS

16-14 Gauge .157 Blue Terminals:

11660 Male, Pk/19 #2111H 10

11661 Female, Pk/7 #2112H 10

WIRE, CABLE & ACCESSORIES

ELECTRICAL

D

In Section D: Meters/Testers Wiring Fuses 12V Accessories Battery Accessories Chargers & Inverters Cords & Adapters Box/Hatch Switches

EAST PENN MANUFACTURING BATTERY CABLE*

- 100% copper conductor.
- Temperature rating of 80°C/176°F @ 60V or less.
- Meets SAE J1
- 2-Gauge cable = 105°C/221°F.



* All East Penn wire & cable products are in compliance with the RoHS standards.

SIZE	BLACK		RED	
	Order #		Order #	
2-Gauge x 25'	13430		13431	
2-Gauge x 50'	746748		746425	
4-Gauge x 25'	13432		13433	
4-Gauge x 50'	746747		746424	
6-Gauge x 100'	755927		755928	



JT&T PRIMARY WIRE

See chart below to order wire in the color and gauge to suit your needs. Carded.



Color	18-Gauge x 30'	16-Gauge x 20'	14-Gauge x 15'	12-Gauge x 12'	10-Gauge x 8'
Red	11408	11415	11422	11429	11436
White	—	—	11423	—	—
Black	11412	11419	11426	11433	—

JT&T QUICK SPLICE



For making top, incline, pigtail wire connections on low voltage wiring.



FOR 18-14 GAUGE WIRE

- 11367** Blue, Pk/6, Midline Tap #1220H 10
- 10313** Blue, Pk/50, Midline Tap #1220F 6
- 10311** Blue, Pk/500 #1220D 6
- 10312** White, Pk/500 #1220-1D 6

FOR 12-10 GAUGE WIRE

- 95131** Brown, Pk/50 #1218F 10
- 95132** Yellow, Pk/50 #1219F 1

JT&T MIDLINE T-TAP WITH FULLY INSULATED MALE



- 10059** Pk/4 16-14 Gauge .250 Nylon Male T Tap #2122H 10



JT&T SEAMLESS TUBULAR COPPER LUGS



Heavy duty lugs flared for easy wire insertion. Features highest grade electrolytic copper, fully annealed for easy secure crimping and AWG identification.



Copper Lugs, Pk/5:

- 16116** 3/8" 6-Gauge #1305F 6
- 16117** 3/8" 4-Gauge #1309F 6
- 16109** 3/8" 2-Gauge #1314F 6

EAST PENN MANUFACTURING COPPER CABLE LUGS

Heavy-duty lugs with flared design. Packages of 50.



Copper Lugs, 3/8" Stud, Pk/50:

- 14725** 2-Gauge #05329 1
- 14027** 4-Gauge #05327 5
- 14026** 6-Gauge #05326 5



11349



11167

JT&T RING TERMINALS

Solderless, flared vinyl insulated.

16-14 Ga., Blue Ring Terminals:

- 10863** Pk/100 #10 Ring #2008C PKG/100 6
- 11349** Pk/14 1/4" Ring #2009H 1
- 10055** Pk/100 1/4" Ring #2009C PKG/100 6
- 11649** Pk/14 3/8" Ring #2011H 1

12-10 Ga., Yellow Ring Terminals:

- 11358** Pk/14 #10 Ring #2014H 10
- 10046** Pk/100 #10 Ring #2014C PKG/100 10
- 11359** Pk/12 1/4" Ring #2015H 1
- 10049** Pk/100 1/4" Ring #2015C PKG/100 6
- 763454** Pk/12 5/16" Ring #2016H 1
- 10051** Pk/100 5/16" Ring #2016C PKG/100 6
- 11361** Pk/12 3/8" Ring #2017H 10
- 10053** Pk/100 3/8" Ring #2017C PKG/100 1

HEAVY DUTY 8 GA. RINGS

Silver brazed seam construction.

8 Ga., Heavy Duty Ring Terminals:

- 11164** #10 Rings, Pk/4 #2019H 6
- 11165** 1/4" Rings, Pk/4 #2020H 6
- 11166** 5/16" Rings, Pk/4 #2021H 6
- 11167** 3/8" Rings, Pk/4 #2022H 6

JT&T QUICK DISCONNECT 16-14 GA. TERMINALS

Fully insulated nylon with .250 tab width.



- 11375** Combo (Male/Female), Pk/5 #2121H 1
- 15463** Female Disconnect, Pk/10 #2116H 10
- 10552** Female Disconnect, Pk/100 #2116C PKG/100 6
- 15464** Male Disconnect, Pk/10 #2117H 1
- 10553** Male Disconnect, Pk/100 #2117C PKG/100 6

JT&T MALE DISCONNECT TERMINALS, VINYL INSULATED



Tab widths are .250.



- Flared Male, 16-14 Ga., Blue: **763502** Pk/100 Male #2106C 1
- Piggyback Male, 16-14 Ga., Blue: **11658** Pk/9 .250 Piggyback Male/Female #2109H 10
- 12-10 Ga., .250, Yellow Quick Disconnect: **763457** Pk/15 Male #2108H 1

JT&T WIRING KITS
IN REUSABLE BOXES

16111



16112



758121



DO IT YOURSELF KIT—

Economy wiring tool and 25 assorted terminals.

DELUXE WIRING KIT—

101 pieces: 100 terminals and wiring tool.

ELECTRICAL TERMINAL ASSORTMENT—

83 piece kit.

16111 83-Pc. Terminal Kit #6982F 6**16112** 101-Pc. Wiring Kit #6992F 6**758121** Terminal Kit #6991F 6

JT&T TOOLS

E-Z WIRE
STRIPPER TOOL

Multi-function, self-adjusting stripper with cutting and crimping actions. 9" long with cushion grip handles that easily cut and strip 26-10 AWG wire, and crimp insulated and non-insulated terminals.

46194 E-Z Wire Stripper #5008F 6

HEAVY DUTY E-Z STRIPPER/CRIMPER

Work with wire the EZ way.

12001 EZ Stripper/Crimper #5020F 1

ECONOMY CRIMPING TOOL

Cushion grip handles gives you the cutting edge. 10" L. Cuts wire, strips 22-10 AWG wire, crimps insulated terminals including 7mm ignition terminals. Cuts/rethreads machine screws.

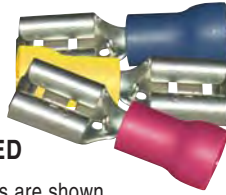
11016 Crimping Tool #5002F 6JT&T
FEMALE
DISCONNECT
TERMINALS
FLARED,
VINYL INSULATED

All fit male tabs. Sizes are shown with each part number.

16-14 Ga., .250 x .032, Blue Female:

747729 Pk/5 #2105B 1**11655** Pk/20 #2105H 1**763501** Pk/100 #2105C 6

12-10 Ga., .250 x .032, Yellow Female:

11657 Pk/15 #2107H 1**763514** Pk/100 #2107C 1JT&T BUTT CONNECTORS
SOLDERLESS, FLARED
VINYL INSULATED

22-18 Ga. Butt Connectors, Red:

11341 Pk/20 #2060H 10**10056** Pk/100 #2060C PKG/100 6

16-14 Ga. Butt Connectors, Blue:

747727 Pk/5 #2061B 10**11345** Pk/20 #2061H 10**10057** Pk/100 #2061C PKG/100 6**11162** Pk/100 Nylon Butt Connectors #2066C PKG/100 6

12-10 Ga. Butt Connectors, Yellow:

747728 Pk/3 #2062B 1**11357** Pk/14 #2062H 10**10058** Pk/100 #2062C PKG/100 6

Heavy Duty 8 Ga. Butt Connectors, Silver Brazed Seam Construction:

11168 Pk/2 #2063H 6

ASSORTED VINYL BUTT CONNECTORS

An assortment of 22-18, 16-14, and 12-10 Ga.

11672 Pk/17 Assorted #2156H 1

BUTT CONNECTOR BULK PACKS

17888 Pk/1000 Butt Connectors, 16-14 AWG #2061M 1**17889** Pk/500 Butt Connectors, 12-10 AWG #2062D 1JT&T ADHESIVE
BACK WIRE TIE
MOUNTS

Package of 10 wire tie mounts.

11712 Pk/10 Tie Mounts #4735H 6JT&T NYLON CABLE
CLAMPS

Durable nylon clamps for channeling cable and wire. 3/8" wide. White.



Nylon Cable Clamps, White:

10791 1/4", Pk/25 #4602H 6**10792** 5/16", Pk/25 #4603H 6**10793** 3/8", Pk/22 #4604H 6**10795** 1/2", Pk/15 #4606H 6

JT&T CABLE TIES



Fast, permanent and self-locking one piece ties that are great for securing and connecting wire bundles, harnesses, hoses, tubing to frames, conduit, etc. Use wire tool #5007 to install ties.

Cable Ties, Weather Resistant for Outdoor Applications, Black:

16327 Pk/14 7" #4706H 6**15392** Pk/100 7" #4706C 6

Cable Ties, Natural Color:

11708 Pk/35 4" #4701H 1**10785** Pk/100 4" #4701C 6**11709** Pk/25 5 1/2" #4703H 6**10787** Pk/100 7" #4705C 6**10788** Pk/100 10 3/4" #4707C 6**10789** Pk/100 14" #4709C 6

Bulk Packs Of Cable Ties, Natural Color:

17906 Pk/1000 7" #4705M 1

Bulk Packs Of Cable Ties, Black:

17907 Pk/1000 7" #4706M 1**17909** Pk/500 10.75" #4708D 1**17911** Pk/500 14" #4710D 1JT&T NYLON SCREW
MOUNT WIRE TIES

Serviceable at temperatures to 275° F, maximum life and strength is attained at temperatures below 185° F. With mounting hole.

16110 Pk/11 Ties, 8" L, Black #4725H 6**16113** Pk/6 Ties, 14 1/2" L, Natural #4728H 6

Screw Mount Wire Ties, 8", Bulk Packs:

17913 Pk/500 Black #4725D 1JT&T
FUSE ADAPTER &
CONNECTOR**16114** ATC Fuse Adapter .250, Pk/10 #1208H 1

In Section D:	Meters/Testers	Wiring	Fuses	12V Accessories	Battery Accessories	Chargers & Inverters	Cords & Adapters	Box/Hatch	Switches
---------------	----------------	--------	-------	-----------------	---------------------	----------------------	------------------	-----------	----------

JT&T HEAT SHRINK TUBING



Highly flexible, flame retardant tubing intended for general purpose automotive applications. It is strong and will not melt or split when shrunk over irregular-shaped objects. Shrinks to 50% of expanded size, as listed below. To use, slide on cable before installing terminals (1). Crimp terminals on wires, and slide tubing over terminals (2). Heat to shrink. (3). Comes in 4" lengths. Black.

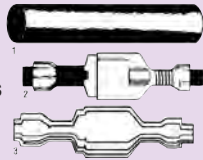

Heat Shrink Tubing (Expanded Size Shown):

- 15465** Pk/7 3/16" #4004H 6
- 11695** Pk/6 1/4" #4005H 6
- 11696** Pk/6 3/8" #4006H 6

Heat Shrink Tubing Assortment, Pk/6:

- 11697** 3/16", 1/4", 3/8" #4051H 6
- 11698** 1/16" through 1" #4053H 6

JT&T FLEX-GUARD FLEXIBLE TUBING

Provides flexible, crush-resistant protection for your wiring assemblies. The split seam feature allows the wires to be inserted easily, eliminating the costly time needed to apply tape, braid or loom.



Packaged Flex-Guard Flexible Tubing:

- 15466** 1/4" I.D. x 14' L #4304F 6
- 11700** 3/8" I.D. x 10' L #4305F 6
- 11701** 1/2" I.D. x 7' L #4306F 6
- 11702** 3/4" I.D. x 5' L #4307F 6

Bulk Packs Of Flex-Guard Flexible Tubing:

- 17919** 100' 1/4" Dia. #4304C 1
- 17920** 100' 3/8" Dia. #4305C 1
- 17921** 100' 1/2" Dia. #4306C 1
- 17922** 100' 3/4" Dia. #4307C 1



TAPA-CIRCUIT WITH DUAL FUSE HOLDER

Turns one fuse slot into two. Plugs into occupied or vacant energized fuse block slot. Provides one fuse holder to protect existing circuit, and a second fuse holder for new circuit. 10-amp rating at 12 volts. 16-gauge lead for new circuit is 5" L; includes insulated crimp-type coupler.

- 11757** Fits Mini Fuse Blocks #30103 12



WIRTHCO MINI-FUSETAPPER™

The revolutionary Mini-Fusetapper™ taps into power at mini-fuseblocks! The device is easy to use. Simply select fuse to be used. Slip Mini-Fusetapper™ over desired fuse leg. Insert fuse and Mini-Fusetapper™ into fuse block. That's it! Now that fuse port is able to be "tapped"! Just use a slip-on terminal to provide power to cellular, stereo, and other applications.

- 18025** Mini-Fusetapper #30800 12



WIRTHCO MINTAPPER™

The Minitapper™ makes it easy to pick up power at the new minifuse blocks. And it's easy to install, remains firmly in place in the new minifuse blocks and assures the user of a dependable power source. Minitappers come with a fully insulated terminal so that the installer needs only to (1) crimp the terminal on the power lead wire, (2) put the terminal on the Minitapper™, (3) insert the Minitapper™ into the hot side of an empty fuseblock cavity, and (4) install an inline fuseholder and fuse in this new hot lead.

- 17873** Mintapper #30100 12



WIRTHCO FUSETAPPER™

The Fusetapper™ is designed to make it easy to add a circuit to new flat automotive fuseblocks. Pick the circuit or fuse that is to be used and simply slip the Fusetapper™ over one leg of the fuse. Then insert the fuse and the Fusetapper™ into the fuseblock. Put the Fusetapper™ on the hot side of the fuse and use an inline fuse and fuseholder to protect your new circuit. Put the Fusetapper™ on the cold side "protected side" of the fuse and the fuse will protect your new circuit. When installed, a quarter inch tab will protrude above the fuse block. Onto this tab place the fully insulated female push-on terminal. After installation is complete, bend the Fusetapper™ flat to the fuseblock to save space.

- 17869** Fusetapper #30001 12

COOPER Bussmann BUSSMANN FUSE HOLDERS

IN-LINE FUSEHOLDERS

For ATC Blade-Type fuses. Electrical rating: 32-V, 2-20A and 2-30A.

In-Line Fuse Holder:

- 13842** 16-Gauge #HHC 10
- 13841** 12-Gauge #HHD 10



Fuse not included.

WATERPROOF SEALED FUSE HOLDER

Nylon body with latching cap. Silicone rubber seals at wires and cap. Extra long 9", 12-gauge leads. Rated 3 to 30 amps. 1/card.

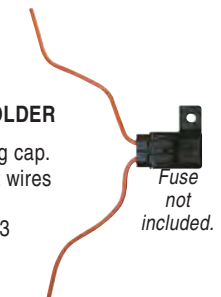

Fuse not included.

- 13840** ATC Fuseholder #BP/HHR 5

SELF-STRIPPING FUSE HOLDER

Self-stripping ATC fuseholder in royal blue. Accepts fuses to 20 amps, 32-V; #18 to #14 AWG copper wire only.



- 13839** In-Line Fuseholder, Pk/2 #BP/HHS 10

MAXI FUSE HOLDER

Fuseholder with cover, 20-60 amps, #6 lead wire. 32-volt.



- 13411** Maxi Fuse Holder #HHX 1

BUSSMANN UNIVERSAL GLASS TUBE FUSE HOLDER

Universal fuseholder in high visibility yellow. Accepts fuses to 30 amps #12 - #18 leads (not included). Crimp type connectors.



- 19252** Glass Tube Fuse Holder, Carded #BP/HHB 1



JT&T FUSE ACCESSORIES

In Line Fuse Holders, Glass Type:

- 11680** 14-Amp 18-Ga. #2526H 5
- 16105** 30-Amp 12-Ga. #2527F 6



ETS FUSE HOLDERS

Nylon screw-type fuse holders with fuse installed.

20 Amp Fuse Holder, 12 Ga. Wire:

- 14714** Packaged #BF20 PKG/1 1
- 10010** Bulk #F20 BULK 25

COOPER Bussmann

BUSSMANN FUSE HOLDER FOR ATC FUSES



Unique feature allows each fuse to be identified. Highly visible yellow identifies holder in hidden areas. 18-gauge.

- 11377** Fuse Holder for ATC Fuses, CD/1 #BP/HHD 5

COOPER Bussmann



BUSSMANN GLASS TUBE FUSES

Glass Tube Fuses, 5/Card except as noted:

- 12221** #AGA-2 #BP/AGA-02 5
- 12222** #AGA-3 #BP/AGA-03 5
- 12223** #AGA-5 #BP/AGA-05 5
- 751180** #AGA-20 #BP/AGA-20 5
- 748739** #AAGA-30 #BP/AGA-30 5
- 12224** #AGC-1 #BP/AGC-01 5
- 747709** #AGC-1.5 #BP/AGC-01.5 5
- 12225** #AGC-2 #BP/AGC-02 5
- 12226** #AGC-2 1/2 #BP/AGC-02.5 5
- 12227** #AGC-3 #BP/AGC-03 5
- 12228** #AGC-4 #BP/AGC-04 5
- 12229** #AGC-5 #BP/AGC-05 5
- 12230** #AGC-7 1/2 #BP/AGC-07.5 5
- 11322** #AGC-10 #BP/AGC-10 5
- 11323** #AGC-15 #BP/AGC-15 5
- 11324** #AGC-20 #BP/AGC-20 5
- 12231** #AGC-25 #BP/AGC-25 5
- 11325** #AGC-30 #BP/AGC-30 5
- 12216** #AGC-40, 5/Tin #AGC-40 1
- 12217** #AGC-50, 5/Tin #AGC-50 1
- 12219** #AGU-50, 10/Box; #AGU-50 1
- 12244** #SFE-6 #BP/SFE-06 1
- 12246** #SFE-9 #BP/SFE-09 5
- 12247** #SFE-14 #BP/SFE-14 5
- 11326** #SFE-20 #BP/SFE-20 5
- 12248** #SFE-30 #BP/SFE-30 5
- 756713** American Car Fuse Assortment: Contains SFE9, 14, 20; AGC10, 15, 30 #UK-6 5



13421

COOPER Bussmann



13845

BUSSMANN PANEL MOUNT FUSE HOLDER

HKP-HH SERIES

High profile cover knob; rear hexnut mounting; 1/4" QC terminals, 15A (250V). For 1/4" x1/4" fuses. Carded.

- 13421** Panel Mount Fuse Holder #BP/HKP-HH 5

HTB-261 SERIES

Low-profile cover knob; rear hexnut mounting; 1/4" QC terminals, 15A (250V). For 1/4" x1/4" fuses.

- 13838** Panel Mount Fuse Holder #HTB-261 10
- 13845** Knob Only f/HTB-261 #FT1 10



BUSSMANN FUSES

ATM MINI FUSE ASSORTMENT

Contains one each: ATM-2, 5, 7 1/2, 15, 20, 25 and 30. Carded.

- 17004** ATM Assortment #KM-8 5

EMERGENCY FUSE KIT FOR U.S. CARS

Contains one each: AGC5, AGC15, AGC30, SFE9, SFE14, and SFE20. Glass fuses carded with puller included.

- 11246** Emergency Fuse Kit #EK-7 5

COOPER Bussmann



BUSSMANN MARINE TIME-DELAY GLASS TUBES

Time-delay fuses are for marine motor protection. Size: 1/4" x 1-1/4". Comes two fuses per package.

Time-Delay Glass Tube Fuses, Pk/2:

- 12794** 15-Amp #BP/MDL-15 5
- 12795** 20-Amp #BP/MDL-20 5
- 13036** 30-Amp #BP/MDL-30 5

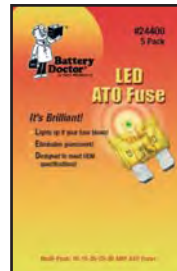

LED ATO FUSE — IT'S BRILLIANT!

- Lights up if your fuse blows!
- Eliminates guesswork!
- Designed to meet OEM specifications!

Multi-pack: 10-15-20-25-30 Amp ATO fuses.

- 14827** ATO LED Smart Fuse, 5 Pack #24400 1

BUSSMANN ATM DIAGNOSTIC KIT

The Bussmann ATM diagnostic kit contains: ATM Diagnostic Kit ATM-2, 5 7-1/2, 10, 15, 20, 25, 30 & FT-3 combination fuse tester/puller.



- 12791** ATM Diagnostic Kit #DIA-2 5

COOPER Bussmann



BUSSMANN ATC AND MAXI FUSE KIT - NO.53

ATC-10,15, 20, & 30A; MAX-30, 40 & 50A and FT-3 Fuse Tester/Puller. The best selling ATC fuses and Maxi-fuses in a convenient resealable container. Great for small shops, do-it-yourself mechanics - or for stocking commercial/service vehicles. The fuse tester tests mini, standard and maxi blade fuses in the fuse block or outside. 45 pieces.

16816 ATC & Max Fuse Kit #NO.53 3



Ideal for Mechanics, Boaters/RVers! BUSSMANN FUSE BONUS PACK #42

This compartmentalized package contains the eight most popular ATC blade type fuses from 3 to 30 amp. It also holds a fuse tester and fuse puller. Fuses included are 5 each of ATC-3, ATC-5, ATC-7 1/2, ATC 10, ATC-15, ATC-20, ATC-25 and ATC-30.

17864 Buss Bonus Pack #NO.44 3



BUSSMAN COMBINATION FUSE PULLER

Carded combination fuse puller.

10477 Fuse Puller #BP/FP-A3 5



BUSSMANN ATC FUSES

ATC Blade fuses were introduced in the late '70s, and are still widely used by automotive OEMs. Buss ATC products use the industry's universal color coding to indicate amperage. Buss ATC fuses feature an enclosed element - offering protection against shocks and sparks, plus corrosion resistance for longer service life. Carded.

ATC REFILLS for ATC Bin Display #225

ATC Automotive Fuses, 5/Card except as noted:

- 756706** 3 Amp #BP/ATC-03 5
- 756707** 4 Amp #BP/ATC-04 5
- 12233** 5 Amp #BP/ATC-05 5
- 756709** 7.5 Amp #BP/ATC-07.5 5
- 12234** 10 Amp #BP/ATC-10 5
- 12235** 15 Amp #BP/ATC-15 5
- 12236** 20 Amp #BP/ATC-20 5
- 12237** 25 Amp #BP/ATC-25 5
- 12238** 30 Amp #BP/ATC-30 5
- 13413** 40 Amp #BP/ATC-40 5

11247 ATC Fuse Assortment-Carded; Contains One each: 5, 7 1/2, 10, 20, 25, and 30 Amp Fuses #AK-6 5

ATC Automotive Fuses in Bonus Packs of 25:

- 17850** ATC-5 #ATC-5RLD 1
- 17851** ATC-7 1/2 #ATC-7-1/2RLD 1
- 17852** ATC-10 #ATC-10RLD 1
- 17853** ATC-15 #ATC-15RLD 1
- 17854** ATC-20 #ATC-20RLD 1
- 17855** ATC-25 #ATC-25RLD 1
- 17856** ATC-30 #ATC-30RLD 1



BUSSMANN FMX SERIES FUSES

Developed to meet the growing OEM demand for low-profile components, the FMX Female Maxi fuse offers high-ampere protection in a compact package.

FMX Series, Carded:

- 13406** 20 Amp #BP/FMX-20 5
- 13407** 30 Amp #BP/FMX-30 5
- 13408** 40 Amp #BP/FMX-40 5

COOPER Bussmann

BUSSMANN BLADE FUSES

Heavy Duty Maxi Blade Fuses, Pk/1:

- 18557** Maxi 20-Amp #BP/MAX-20 5
- 17989** Maxi 30-Amp #BP/MAX-30 5
- 17990** Maxi 40-Amp #BP/MAX-40 5
- 17991** Maxi 50-Amp #BP/MAX-50 5
- 17992** Maxi 60-Amp #BP/MAX-60 5

ATM Mini Fuses, 5/Card:

- 18558** ATM-3 #BP/ATM-3 5
- 18559** ATM-4 #BP/ATM-4 5
- 18560** ATM-5 #BP/ATM-5 5
- 18561** ATM-7.5 #BP/ATM-7.5 5
- 18562** ATM-10 #BP/ATM-10 5
- 18563** ATM-15 #BP/ATM-15 5
- 18564** ATM-20 #BP/ATM-20 5
- 18565** ATM-25 #BP/ATM-25 5
- 18566** ATM-30 #BP/ATM-30 5



BUSSMANN FUSIBLE LINKS

FLS SERIES

Used primarily in Japanese designed models to provide wiring harness protection.

FLS series has female mini terminations.

Fusible Link:

- 13018** 30 Amp, Pink #BP/FLS 30 5
- 13019** 40 Amp, Green #BP/FLS 40 5

FLF SERIES

Used primarily in Japanese designed car models to provide wiring harness protection.



FLF Series, Female Terminations, Carded:

- 13409** 30 Amp #BP/FLF-30 5
- 13410** 40 Amp #BP/FLF-40 5

ETS PLASTIC A.T.C. FUSE ASSEMBLIES

Eight inch loop of wire gauged for proper protection with color code for easy identification. White wire. 12-gauge.

Plastic ATC Fuse Assembly:

- 17993** 20-Amp #ATC20 BULK 25
- 17994** 30-Amp #ATC30 BULK 25



A fuse must be properly and fully inserted into the holder to provide a solid connection. Poor or improper insertion of the fuse can result in failure of the fuse and holder, thus not protecting the device for which it was intended.

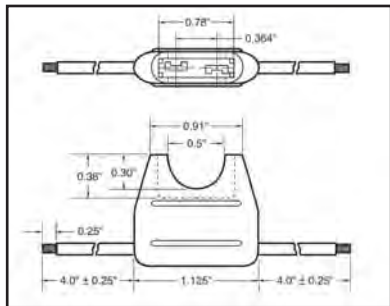

COOPER BUSSMAN AUTOMOTIVE BLADE-TYPE FUSE HOLDERS

In-line fuse holders for ATC® Blade-Type fuses. Ratings: • Volts: — 32Vdc. • Amps:— 80% continuous of fuse rating.

Black Fuse Holder with cover (Electrical connection, Fuse Amps):

- 11797** #16 yellow leadwire, 1-20 Fuse amps #BP/HHF 5
- 11805** #12 yellow leadwire, 1-30 Fuse amps #BP/HHG 5

COOPER Bussmann BUSSMAN ATC BLADE-TYPE FUSE PANEL



Interchangeable Blade Terminals: Accepts ATC® blade type fuses or Series 22X circuit breakers. **Wiring:** Output terminals - .250" x .032" QC rated 30A max. per circuit; Input terminals - #10-32 stud input rated 100A max. **Recommended Wire Size:** Input Power #4-6; Output Circuits #12-16. **Positions:** Provides 4 to 20 output circuits. **Material:** Black, UL rated 94VO thermoplastic, -20°F to 150°F (0°C to 65°C). **Applications:** Compact and lightweight, yet rugged enough for use in trucks, buses, boats, RVs, etc. Recommended for supplemental accessory power requirements. **Features:** No top cover needed; recessed trifurcated fuse contacts. Recessed mounting holes.

- 13855** ATC Fuse Block #15600-06-20 10



Fuse not included

BLUE SEA SYSTEMS ANL 300 FUSE BLOCK



Insulating cover satisfies ABYC/USCG insulation requirements and protects conductive components. For use on systems up to 32 Volts DC. Large 5/16"-18 studs accept 5/16" (M8) ring terminals, 14 AWG to 2/0 AWG wire. Cover breakouts allow wire access in any direction. Insert molded 5/16"-18 studs ensure secure fuse mounting and accept 5/16" (M8) ring terminals, 14 AWG to 2/0 AWG wire. Stainless steel studs provide resistance to corrosion and high torque for excellent contact. Swing-out design allows replacement of the fuse without removing fasteners. US 94-VO base resists high heat.

Specifications:

- Maximum Amperage 300 Amperes DC.
- Maximum Voltage 32 Volts DC. Terminal Stud Torque 132 in-lb. (14.9 N-m).
- Base Material Reinforced PBT.
- Cover Material Polycarbonate.
- For ANL Fuses 35-300 Amperes (not included).
- Size: 4.5" L x 1.5" W; mounting holes for #10 screws 3.875" centers.

- 12995** ANL 300 Fuse Block with Cover #5005 5

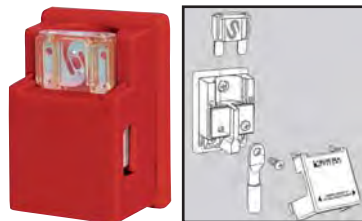

BLUE SEA SYSTEMS MAXI™ FUSE BLOCK

The most economical fuse block for 30-80 Ampere fusing. Snap-on terminal cover insulates all conductive parts, satisfying ABYC/USCG requirements. Accepts wire sizes 18-4 AWG from sides or bottom. For use on systems up to 32 Volts DC. Terminal screws compress fuse blades within blocks for low resistance connections. Accepts Maxi™ Fuses. **Specs:** • Maximum Voltage: 32 Volts DC. • Maximum Amperage: 80 Amperes. • Fuse Type: MAXI™ Fuses. • Fuse Rating: 30-80 Amperes. • Base Material: Reinforced Polycarbonate. • Dimensions 2.89" H x 2.015" W.

- 12996** Maxi™ Fuse Block #5006 5



BLUE SEA SYSTEMS

3AG FUSE BLOCK SYSTEM



• Clear insulating cover with label recesses for standard Blue Sea Systems' labels. • Cover insulates all conductive parts, satisfying ABYC/USCG requirements and storing spare fuses. • Tin-plated copper buses and beryllium copper fuse clips give full 30-ampere rating per circuit. • Uses AGC (fast acting), MDL (time-delay) and all other 3AG glass fuses.

- 12547** Fuse Block 3AG, 6 Circuit with ground #5015 5

ATO/ATC FUSE BLOCK SYSTEM

Integral Ground Bus Style



• Clear insulating cover with label recess for small format Blue Sea Systems' labels. • Cover insulates all conductive parts, satisfying ABYC/USCG requirements. • Tin-plated copper buses and fuse clips give 30-ampere rating per circuit. • Accepts ATO and ATC fast acting blade type fuses and plug-in style circuit breakers.

Fuse Block ATO/ATC, w/ground:

- 12539** 6 Circuit #5025 5
- 12541** 12 Circuit #5026 5



UL Listed, CSA Certified.

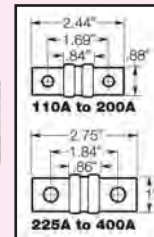

BUSSMANN CLASS T-TRON FUSES

Extremely fast short-circuit response. Voltage rating: 15-600A 160-Vdc. Interrupting rating: 20,000A dc @ 160-Vdc.

Class T Fuse:

- 13835** 200-Amp #JJN-200 1
- 13836** 300-Amp #JJN-300 1

In Section D:	Meters/Testers	Wiring	Fuses	12V Accessories	Battery Accessories	Chargers & Inverters	Cords & Adapters	Box/Hatch	Switches
---------------	----------------	--------	-------	-----------------	---------------------	----------------------	------------------	-----------	----------



BLUE SEA SYSTEMS ANL FUSES

6,000 Ampere Interrupt Rating satisfies ABYC requirements for main DC circuit protection on large battery banks. Ignition protected - safe for installation aboard gasoline powered boats. Silver-plated connector blades for corrosion resistance. Visible indication of blown fuse condition.

Specifications:

- Interrupt Rating: 6,000 Amperes DC.
- Maximum Voltage: 32 Volts DC.
- Meets SAE J1171 external ignition protection requirements (35-300 amperes only).

ANL Fuse:

- 12997** 50 Amp #5122 5
- 12999** 100 Amp #5125 5
- 13001** 200 Amp #5129 5
- 13637** 300 Amp #5133 5

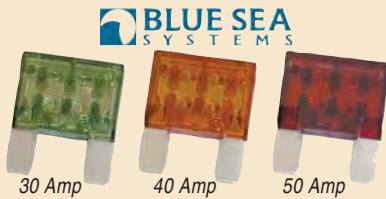

BLUE SEA SYSTEMS MAXI™ FUSES

- Economical • Tin-plated connector blades for corrosion resistance. • Visible indication of blown condition. • Interrupt Rating: 1,000 amp DC.
- Maximum Voltage: 32 Volts DC.
- Size: 1.155" W x 1.36" H (includes blade).

Maxi™ Fuse:

- 13002** 30 Amp #5138 10
- 13003** 40 Amp #5139 10
- 13004** 50 Amp #5140 10

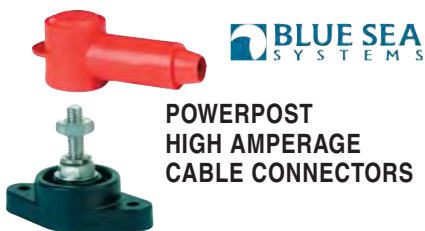

POWERPOST HIGH AMPERAGE CABLE CONNECTORS

Connects high amperage cables securely.

- Max. voltage rating: 48 volts DC.
- Base material: Reinforced Thermoplastic.
- Size: 3.3" x 1.75" overall. Mounting holes for 1/4" screw 2.5" centers.

- 12982** PowerPost 5/16" x 7/16" Stud #2002 5
- 12542** PowerPost 3/8" x 7/8" Stud #2003 5



BLUE SEA SYSTEMS 150 AMP COMMON BUSBARS

The industry standard bus for positive distribution or for the collection of negative or AC ground circuits. **Specifications:**

- Continuous Amperage: 130A AC/150A DC.
- Max. Voltage Rating: 300V AC/48V DC.
- Bus Material: Tin-Plated Copper CDA 110/UNS11000.
- Base Material: Reinforced Polycarbonate.
- Cover Material: Clear Polycarbonate.
- Size, #2301: 5.875" L x 1.25" W x 0.75" H; mounting holes for #10 screw, 5.25" centers.

- 12544** BusBar 10 x 8-32 Screw Terminal #2301 5



30 AMP TERMINAL BLOCKS

Closed back design completely insulates power from the mounting surface. Each screw pair is 1 isolated circuit. Jumpers allow creation of common circuits. **Specifications:**

- Continuous Rating: 30 Amperes AC/DC.
- Maximum Voltage Rating: 600 Volts AC/DC.
- Bus Material: Nickel-Plated Brass.
- Base Material: Phenolic.
- Screw size: #8.

- 12985** Terminal Block, 4 Circuits; 3.22" L x 1.31" W; mounting holes for #10 screws 2.81" x 0.5" centers #2504 5
- 12986** Terminal Block, 6 Circuits; 4.34" L x 1.31" W; mounting holes for #10 screws 3.93" x 0.5" centers #2506 5



POWERPOST PLUS CABLE CONNECTOR

150 ampere bus allows small wire connections at high amperage cable connections.

- Size: 3.3" x 1.75" overall.
- Mounting holes for 1/4" screw 2.5" centers.
- 12543** PowerPost Plus 3/8" #2103 5

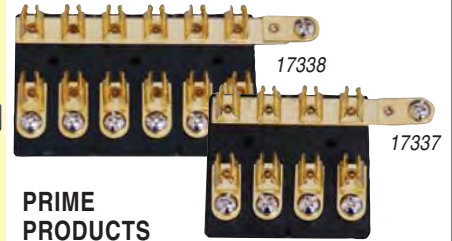

PRIME PRODUCTS HEAVY DUTY FUSE BLOCK

These fuse blocks are equipped with a common buss bar on one end and screw connection on the other end. Will accommodate both AGC and SFE fuses. Card with blister pack.

HD Fuse Block:

- 17337** 4-Gang #08-3004 24
- 17338** 6-Gang #08-3006 24



PARALLAX POWER SUPPLY BREAKERS

PLUG-IN BREAKERS

- ONE POLE:** • HACR. • SWD rated. • Requires one 1" space. • 120/240-VAC. • 10,000 AIC.
- TWO POLE:** • HACR. • Requires two 1" spaces. • 120/240-VAC. • 10,000 AIC.

One Pole - Plug In:

- 14400** 15 Amp #UBITB115 1
- 14401** 20 Amp #UBITB120 1
- 14402** 30 Amp #UBITB130 1
- 14403** 40 Amp #UBITB140 1

Two Pole - Plug In:

- 14405** 50 Amp #UBITB250 1

DUPLEX BREAKERS

- HACR. • SWD rated.
- 120/240-VAC.
- 10,000 AIC.
- Requires one 1" space.



Twin Pole - Plug In:

- 14406** 15/15 Amp #UBITBBD1515 6
- 14408** 15/20 Amp #UBITBBD1520 6
- 14409** 30/15 Amp #UBITBBD3015 6
- 14407** 20/20 Amp #UBITBBD2020 6
- 14410** 30/20 Amp #UBITBBD3020 6

BUSSMANN BREAKERS

CIRCUIT BREAKER



Non-corrosive molded cover eliminates grounding when operating against a faultline. Ratings: 8-A to 50-A; 12-VDC.

Bulk Circuit Breaker:

- 13846** 20-Amp #CBP-20BA 10
- 13847** 25-Amp #CBP-25BA 10
- 13848** 30-Amp #CBP-30BA 10
- 13849** 40-Amp #CBP-40BA 10
- 10262** 50-Amp #CBP-50BA 10

Carded Circuit Breaker:

- 13854** 30-Amp #BP/CBP-30BA 10
- 13853** 50-Amp #BP/CBP-50BA 5

SNAP-IN CIRCUIT BREAKER

12-volt remote reset circuit breaker replaces round glass style fuses in existing fuse blocks. Opens automatically on overload. Remains open for protection until trouble is corrected.



Bulk Snap-In Circuit Breaker:

- 13851** 30-Amp #CBF-30 1



PANEL-MOUNTED BREAKERS

Used in trucks, RVs, boats, buses, etc. with .25" straight terminals.

Panel-Mounted Breakers:

- 13418** 10 Amp #CB174M-10 1
- 13419** 15 Amp #CB174M-15 10
- 13420** 20 Amp #CB174M-20 10



COOPER Bussmann

13414

BUSSMANN HIGH-AMP CIRCUIT BREAKERS

These high-amp, Type III circuit breakers are typically used in auxiliary and accessory circuits for trucks, buses, RVs and marine applications. Carded.

High-Amp Circuit Breakers, Flush Mount:

- 13414** 80 Amp #BP/CB185-80 4
- 13415** 100 Amp #BP/CB185-100 4
- 13416** 135 Amp #BP/CB185-135 1
- 13417** 150 Amp #BP/CB185-150 4

COOPER Bussmann BUSSMAN FLASHERS SUPER HEAVY DUTY FLASHERS



Perfect for trailer towing and lasts up to 10 times longer than thermal flashers! The 750 replaces most 12V, 3-terminal flashers and the 752 replaces most 12-V, 2-terminal flashers. 2 to 10 lamp capacity. Sold in Visi-Paks.

- 17490** #752 Flasher #BP/232 5

HEAVY DUTY TRAILER TOWING FLASHER

- 14840** #575 Flasher and Hazard Warning, 2 to 4 lamp capacity #BP/575 5

HEAVY DUTY FLASHERS

Replaces most 12-V, 2-terminal flashers. 2 to 3 lamp capacity. Sold 1/box.

- 10176** #552 HD Flasher #BP/552 10



PARALLAX POWER SUPPLY 12 CIRCUIT DC FUSE PANEL BOX

The PPS Panel Box lets you wire 12 independently fused DC circuits, each with capacity of 20 amps, while the total capacity of the Box is limited to 85 amps. Includes 3 DC positive terminals and a chassis mounted ground terminal bus. Ideal when replacing a converter/charger that has an internal fuse panel with one that does not. Hinged lid snaps in place.

- 13048** Enclosed DC Fuse Block, 12 Circuits #FB12 1



ROADPRO CIGARETTE LIGHTER CORD, 10' COILED, PLATINUM

• Plugs into your cigarette lighter socket to use more 12-volt products. • 10' coiled cord. • Fused cigarette lighter plug. • Finger grip cigarette lighter plug with green LED Indicator. • Dual spring contacts for maximum conductivity. • Rolled metal insets with safety caps. • Heavy duty 10-gauge copper wire and heavy duty stain relief. • Has a 10-amp fuse.

- 12405** 10' Lighter Extension Cord #RPPS-2231 1



ROADPRO "CLIP-ON" CIGARETTE LIGHTER ACCESSORY ADAPTER

• Power your larger 12-volt products with your battery clips. • 2' extension cable. • Runs 12-volt appliances by connecting directly to battery terminals.

- 12404** 12V Adapter #RPPS-APS 5



ROADPRO DUAL CIGARETTE LIGHTER ADAPTER, PLATINUM

• Plugs into your cigarette lighter socket to use more 12-volt products. • Fused cigarette lighter plug. • Finger grip cigarette lighter plug with green LED indicator. • Dual spring contacts for maximum conductivity. • Rolled metal insets with safety caps. • Heavy Duty 10-Gauge copper wire and heavy duty stain relief.

- 12403** Dual Adapter #RPPS-223 10



PRIME PRODUCTS 12V 25' EXTENSION CORD

Use this handy extension cord for 12-volt spotlights, fans, TV sets and more. Cord consists of a fused cigarette lighter plug, 25 feet of wire and a 12-volt receptacle.

- 17350** 25' 12V Extension Cord #08-0917 24



PRIME PRODUCTS CIGARETTE LIGHTER PLUG WITH TERMINALS

No need for solder or bulky wire splicing. Crimp on terminals make for a neat connection directly to the back of the plug.

- 17400** Cigarette Lighter Plug w/terminals #08-1903 24

In Section D:	Meters/Testers	Wiring	Fuses	12V Accessories	Battery Accessories	Chargers & Inverters	Cords & Adapters	Box/Hatch	Switches
---------------	----------------	--------	-------	-----------------	---------------------	----------------------	------------------	-----------	----------

PRIME PRODUCTS 12-VOLT OUTLET

Universal 12-volt outlets. Chrome plated. 10157 has a large plate: 4-1/2" x 2-3/4"; 10257 has a mini-plate: 2-5/8" x 1-5/8".



12-Volt Utility Outlet:

- 10157** Large Plate #08-5010 24
- 10257** Mini-Plate #08-5015 24

PRIME PRODUCTS DUAL 12V RECEPTACLE

Easy to mount, this receptacle provides convenient access to 12-volt power.

- 17339** 12V Dual Receptacle under dash, Card with blister pack #08-5040 10



CAMCO 3-OUTLET 12V POWER STRIP

Installs almost anywhere in your RV. Get three times the use from an existing 12V outlet. Outlet covers help protect adapter's unused outlets, making it ideal for use in an exterior storage compartment. Connects directly to your: auxiliary/deep cycle battery.

- 16936** 3-Outlet, 12V Power Strip #42223 6



ROADPRO JUMPSTART/POWER STATION/ COMPRESSOR

- Jumpstart gets your dead battery going with 300 cold cranking amps.
- Reverse polarity indicator ensures correct hook-up.
- 260 PSI Air compressor inflates tires fast and easy.
- Sealed lead acid battery.
- Can be recharged at home or in your vehicle with adapters.
- Convenient charging indicators.
- High impact rubberized housing for safe secure grip.
- LED Battery level Indicator.
- On-board outlet for powering 12-Volt devices with short circuit protection.
- Safety On/Off switch.
- Includes AC & DC charging adapters and inflator nozzles.

- 15019** Jumpstart/Power Station w/Air Compressor. #RPAT-774 2



KWIK TEK JUMPER CABLES

If you never have jumper cables when you need them, it's probably because they've never been the neatest or most convenient thing to stow. That is, until now! These 8' long heavy-duty 8-gauge copper jumper cables are big on charging power, yet stow conveniently in the 9" x 9" nylon bag. The clamps are copper zinc plated to stay like new even in a marine environment. Flexible to 20° below; 200-amp rating.

- 78994** Jumper Cables, Pair #JC-8 6

EAST PENN MANUFACTURING

UNIVERSAL AUTO TERMINALS

Heavy duty battery terminals on a display card of 10.



- 751660** CD/10 Clamp Terminals #00369 10

Emergency Terminal:

- 12427** Each #05300 5
- 10185** Card of 2 #00147 6



Marine Terminal with Stud:

- 11895** Each #05307 1
- 749269** Card of 2 #00354 10

BATTERY TERMINALS

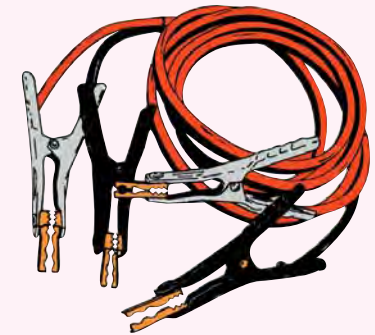

EAST PENN MANUFACTURING BATTERY BOOSTER CABLES

Booster cables fit both post and side terminal batteries. Easy-grip, low-profile clamps attach easily in hard-to-reach battery situations. Dual, tangle-free cables are 100% copper.

- 12705** 12' Cables #00160 1

ATTWOOD BATTERY CLIPS

Quick-connect battery clips for 12-volt electrical accessories.

10-amp rated, copper-plated construction with red and black handle grips. For use with wire up to 10-gauge. Skin pack, pair.



- 614258** Battery Clips, 10-amp, maximum, 3" x 1-1/8" #14258-6 6

MOELLER MOLDED RUBBER CABLE BOOTS

Required by Coast Guard and BIA regulations. One size fits all. Sold in packs of 2.



- 747272** Cable Boots #099078-10 12



**POWERHOUSE
BATTERY BOXES & ACCESSORIES**



BATTERY TRAY

This heavy-duty, molded, all-plastic battery tray comes in two sizes. #11792 fits group 24 batteries and #11794 fits group 27 and 31 batteries. Easy to install and use.

Powerhouse Battery Tray:

- 11792** Group 24 #11792 24
- 11794** Group 27 #11794 24



BATTERY TRAY WITH STRAP

Heavy-duty, molded battery tray features a polypropylene strap with a positive locking quick disconnect buckle.

Battery Tray with Hold-Down Strap:

- 11853** Group 24 #11853 1
- 11854** Group 27 and 31 #11854 1



AT BATTERY BOXES

Heavy-duty "strap style" boxes are vented, and meet Coast Guard Spec 183.420. Made of lightweight, high-strength polypropylene to withstand impact and battery acid. Includes box, lid, strap and mounting brackets with screws. Black.

AT Battery Box:

- 13034** Group 24 #13034 6
- 13035** Group 27 #13035 6

GC2 BATTERY BOX

An extra inch of height to fit 6-volt golf cart batteries.

- 13228** GC2 Battery Box #13228 6



BATTERY HOLD-DOWN STRAP

Battery hold-down strap includes a woven polypropylene strap with firm grip buckle plus a hardware kit of two polypropylene tie-down brackets with stainless steel screws.

Battery Hold-Down Strap with Hardware:

- 12024** 42" Strap #12024 1
- 11796** 54" Strap #11796 40
- 12026** Hardware Kit only #12026 1

ATTWOOD GROUP 31 BATTERY BOX

Vented black battery box for larger applications (9-3/4" maximum battery height). Battery box meets ABYC Standard E-10 and U.S. Coast Guard Specification Number 183.420 as an OEM-installed battery hold-down system. Polypropylene construction for total acid resistance. Hold-down straps resist 350 pounds of force, nearly four times the USCG requirement. Drop tested in temperatures ranging from -20°F to +120°F. Mounting hardware is included. Other features: • 4 cable openings, enlarged to .55" diameter. • Larger handles with rolled edges. • Instructions molded inside cover. Overall dimensions including top: 18-3/4" L x 9-1/4" W x 10-1/4" H.

- 43430** Attwood Group 31 Battery Box #9084-1 6



68031



LEOCH BATTERY CORPORATION

Batteries must be brought up to full charge before use.

9AH SEALED LEAD ACID BATTERY

• Nominal Voltage: 12V. • Nominal Capacity (10HR): 8AH. • Dim: 5.91" L x 2.68" W x 4.13" H. • Weight: 6.17 lbs (Battery with acid); 1.12 lbs (Electrolyte). • Sealed and non-spillable AGM battery. • Maintenance-free. • Powerful 115 cold cranking amps. • Shipped pre-charged and ready to install. • Replaces LT9B-BS battery. CAPACITY AFFECTED BY TEMPERATURE: 106% at 40°C (104°F), 100% at 25°C (77°F) and 86% at 0°C (32°F) and 65% at -15°C (5°F).

Fits on the following Kipor Generator: • IG3000E (66337) only when used with #68041 battery adapter plate and if the unit was originally equipped with #67230 (Mfr # 6FM-6.5) made by Furuide; • KGE3000TI (65843), IG3000 (65788) only when used with new battery hold down strap and bolt spacers (68682) and if the unit was originally equipped with # 66285 (Mfr# 6-FM-9) made by Furuide; • IG3000 and IG3000E CARB or CETL (67434, 67325, 67435, 67435).

- 68029** 9AH Sealed Lead Acid Battery #LT9B-4 6

- 68670** Adaptor for LT9B-4 battery #KGE3300TI-17001A 1

- 68681** Battery Plate #KGE3000TI-17001A 1

- 68682** Hold Down Bolt #KGE3000TI-17002A 1

14AH SEALED LEAD ACID BATTERY

• Nominal Voltage: 12V. • Nominal Capacity (10HR): 11.2AH. • Dim: 5.91" L x 3.43" W x 4.33" H. • Weight: 8.59 lbs (Battery with acid); 1.75 lbs (Electrolyte). • Sealed and non-spillable AGM battery. • Maintenance-free. • Powerful 230 cold cranking amps. • Shipped pre-charged and ready to install. • Replaces none battery. CAPACITY AFFECTED BY TEMPERATURE: 106% at 40°C (104°F), 100% at 25°C (77°F) and 86% at 0°C (32°F) and 65% at -15°C (5°F).

Fits on the following Kipor Generator: • KGE5500E (65798) only when used with adapter (68684) and if unit was originally equipped with #66285 (Mfr# 6-FM-9) made by Furuide; • KGE6000Ti; • IG6000 (66021); • IG6000THi; • IG6000E and IG6000H CARB or CETL (66338, 66336, 67437, 67327); • KGE5500E CARB or CETL (67439, 67527).

- 68031** 14AH Sealed Lead Acid Battery #LTZ14-4 6

- 68684** Battery Adapter #KGE5500E-C-03500 1

35AH SEALED LEAD ACID BATTERY

• Nominal Voltage: 12V. • Nominal Capacity: 35AH. • Dim: 7.68" L x 5.12" W x 6.46" H (Container); 7.09" H (Total Height with terminal). • Weight: 23.15 lbs. • Standard terminal: T5/T6/T12. CAPACITY AFFECTED BY TEMPERATURE: 103% at 40°C (104°F), 100% at 25°C (77°F) and 86% at 0°C (32°F).

Fits on the following Kipor Generator: • KDE5000TA (65801); • KDE5000E (65848).

- 68032** ^{LS} 35AH Sealed Lead Acid Battery #DJW12V-35 1



BATTERY DOCTOR by WIRTHCO



THE "SMU" GM TRUCK BATTERY BOLT

GM Diesel Trucks now come with two cables stacked on the side-mount battery. This often creates a problem. The SMU-GM is perfect for this application. The dimensions are just right for the job. Just remove the OEM battery bolt and replace it with the SMU-GM. Re-install the cables as they were, but now there is a $\frac{3}{8}$ " stud on which to hang the new install wires!

17872 GM SMU Bolt #30500 12

"SMU" SIDE-MOUNT UNIVERSAL BATTERY BOLT



The simplest way to connect power to communication equipment and accessories on cars and trucks with side-mount batteries. Just remove the old battery bolt and replace it with the SMU Side-Mount Universal Battery Bolt. Then use $\frac{3}{8}$ " ring terminals to connect to the battery. And if two batteries are to be connected in series or parallel, no problem! Just turn the second battery terminal over so that it seats properly on the SMU.

17871 Side-Mt. Bolt & Nut #30300 12



TMU TOP MOUNT UNIVERSAL BATTERY BOLT

No more need to remove top mount battery terminals. Just remove the nut from the battery bolt and replace it with the TMU. Then tighten and leave it there. Afterward simply put the nut on the end of the TMU to hold your power leads tightly in place. TMU universal bolts reduce corrosion interference, because the power leads are at the end of TMU away from the corrosion. Another use: hook the power lead to the positive post with the aid of the TMU and use an active ground wire and TMU to complete the circuit to the negative post. Reduces noise!

17870 TMU Bolt & Nut #30600 1

BATAP SIDE-MOUNT BATTERY TAP

Makes ideal frame ground, too!



BaTap is a plate with three tabs that mounts under the battery terminals of side-mount batteries. BaTap gives you a more efficient method to pick up a power lead right at the battery (minimum noise) sidepost. The 3 tabs accept lead wires (from 10 to 22 gauge) that have a slip-on terminal, making it simpler to install a hot lead at the battery.

17868 Side-Mount Tap #30700 1

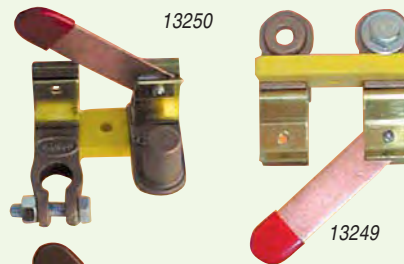

SAFETY/ SWITCH BATTERY DISCONNECTS

The easy way to disconnect electrical power on any vehicle, without tools. Simply lift the knife; power is cut. Prevents shorts and fires when working on electrical systems; discourages theft; eliminates battery drain on idle batteries.

Battery Disconnect:

13250 For Negative or Positive Top Terminal Batteries #20138 6

13249 For Side Terminal GM-type Batteries #20128 6

TM-8W BATTERY DISCONNECT

Opens vertically and has a threaded post and wing nut. This disconnect accommodates a variety of versatile wire leads. 3" x 4" x 2 $\frac{1}{4}$ " H.

17867 TM-8W Disconnect #20148 6



DISCONNECT SWITCH WITH FUSED BYPASS

To disconnect power, loosen green knob, or for anti-theft, completely remove. 6, 12 or 24V. Rated at 125 amps continuous, 500 amp surge. Fits top post batteries. This switch allows the battery to be disconnected without disrupting computer settings. 15Amp bypass fuse maintains trickle current to radio, clock, etc. Size: 3-1/2" x 1-3/8" x 1-1/4". U.S. Patent #397,091.

11758 Fused B/P Switch #20309 12



SAFETY SWITCH IN-LINE DISCONNECT

Mounts under hood or other location. Run a new cable to the switch, connect the battery cable to the post on the switch. Does not attach to battery. For permanent installation where disconnection of battery power is desired near the operator, or hidden as a theft deterrent. Capacity is equal to a #1 AWG battery cable; for all voltage systems.

14649 Safety Switch #20188 6



BATTERY DISCONNECT STOP-K MASTER SWITCH

Key is removable in OFF position. At 12-volt: 1,000A surge, 100A continuous. At 24-volt: 500-amp surge, 50A continuous. With extra key, waterproof cap. 3 $\frac{1}{2}$ " x 2 $\frac{1}{4}$ " x 2 $\frac{1}{4}$ ". Ideal for marine use!

11756 Battery Switch #20314 6