

## HUSKY Quest® Proportional Brake Control

### Advanced Proportional Controller Mirrors the Braking Action of the Tow Vehicle.

The easy to use Husky Quest requires no leveling and is packed with features to provide the ultimate ease in setting and adjusting for safe, smooth stops. **Features:** • Fully Digital settings for power level (gain) and sensitivity (response) makes this the easiest brake control to set and the most repeatable in use after use.

- On the fly sensitivity adjustment; 5 preset options for optimal control from the touch of a button.
- Easiest to adjust settings for full and empty loads time and again.
- Easy to read digital power scale from 5-to-99.
- Advanced inertial accelerometer instantly activates brakes.
- Advanced proportional controller mirrors braking action of the tow vehicle.
- No pendulum, no problem!
- Flexible mounting options.
- 8-brake capacity.
- Innovative vertical slide is easier to see and use than traditional horizontal slides.
- Short-proof protected.
- Lifetime Warranty.

Use appropriate wiring harness for quick brake control installation.



**BEST  
VALUE**



Description	With Flat Connector	
Quest Brake Control with Connector	31899	

## HUSKY Escort® Digital Time-Ramp Trailer Brake Control

The Husky Escort Digital Brake Control has a large digital read-out, and an easy-to-set, easy-to-adjust power setting. The Escort Digital also has an innovate vertical slide for manual braking. The display indicates the exact braking force as a percentage of full power. Its Plug-In Simple connector allows for instant connects and disconnects to your factory tow package with the use of the appropriate custom wiring harness (not included; see the Custom Wiring Harness page). You can mount the Escort Digital in any position vertically or horizontally. The Escort Digital has a 6-brake capacity, and is short-proof protected. It activates the tow vehicle brake pedal. Limited lifetime warranty. Use appropriate wiring harness for quick brake control installation.



Description	With Flat Connector	
Husky Escort Digital Brake Control with Connector	31898	

## HUSKY Escort® Time-Ramp Trailer Brake Control

Husky's economical Escort Brake Control has a 6-brake capacity and an innovative vertical slide for manual braking. Its multi-color LED display changes color with braking power, to help you set the right braking power. You can mount the Escort in any position vertically or horizontally. The Escort is short-proof protected. It activates the tow vehicle brake pedal. Limited lifetime warranty.



Description	Part #	
Escort Brake Control without Connector	31555	

# BRAKE CONTROLS





## TOWING & SAFETY

N

In Section N:	Hitches	Hitch Accessories	Car Towing	Levels	Mirrors & Safety	Brake Controls	Towing Electrical	Brake & Wheel	Automotive
---------------	---------	-------------------	------------	--------	------------------	----------------	-------------------	---------------	------------

## HUSKY Custom Wiring Harnesses for Brake Controls

For the **Husky Quest<sup>®</sup>, Escort<sup>®</sup> Digital and Ascent**. These fit all Husky brake controls that have a similar shaped plug. Simply attach the adapter to the Husky brake control. The safest/easiest way to wire a brake control to your tow-prepped vehicle. Clamshell packed.

Husky Custom Wiring Harness (with OEM specific under-dash connector & brake control mating connector)			
	Square Connector	Flat Connector	
Fits: • <b>CHEV/GMC/CADILLAC</b> 1999-2002 Silverado; 2000-02 Suburban/Tahoe; 2002 Avalanche; 1999-02 Denali; 2000-02 Denali XL; 1999-2002 Sierra; 2000-02 Yukon/Yukon XL; 2000-02 Escalade	31708	31865	 31701
Fits: • <b>CHEV/GMC/CADILLAC/HUMMER</b> 2003-06 Silverado; 2007 Silverado Classic; 2003-06 Suburban/Tahoe; 2003-06 Avalanche; 2003-06 Denali/Sierra; 2007 Sierra Classic; 2003-06 Yukon; 2003-06 Escalade; 2003-07 H2; 2005-07 H2 SUT	31710	31866	
Fits: • <b>GM/CHEVY/BUICK/SATURN</b> 2007-12 Acadia; 2009-12 Traverse; 2008-12 Enclave; 2007-09 Outlook		31871	
Fits: • <b>DODGE/CHRYSLER</b> 1995-09 Ram Pickups; 1997-2011 Dakota; 1998-2009 Durango; 2007-09 Aspen	31707	31864	
Fits: • <b>DODGE</b> 2010-12 Ram Pickups		31869	
Fits: • <b>DODGE</b> 2011-12 Durango		30012	
Fits: • <b>FORD</b> 1992-93 F-Series, Bronco	31700	31859	
Fits: • <b>FORD</b> 2005-07 F-250/F-350; 2005-10 F-450/F-550	31704	31861	
Fits: • <b>FORD</b> 2009-12 F-150; 2009-12 E-150/250/350	31706	31862	
Fits: • <b>FORD</b> 2008-12 F-250HD/F-350	31698	31863	
Fits: • <b>FORD/MERCURY/LINCOLN/LANDROVER</b> 1994-08 F-150; 1994-04 F-250/350; 1997-2011 Expedition; 1994-98 + 2003-08 Van (full size); 2000-05 Excursion; 1995-2003 Windstar; 2009-11 Flex; 2000-10 Explorer; 2000-11 Mountaineer; 1994-96 Bronco; 2005-11 Range Rover; 2005-10 LR3; 2010-11 LR4; 2007-08 Mark LT; 2010-12 MKT; 1998-2011 Navigator	31701	31860	 31704
Fits: • <b>HONDA</b> 2009-12 Pilot; 2006-12 Ridgeline	31686	31868	
Fits: • <b>NISSAN/INFINITI</b> 2004-12 Armada/Titan; 2005-12 Frontier; 2004-11 QX-56; 2005-12 Pathfinder; 2004-08 Xterra; 2012 NV Van	31699	31858	
Fits: • <b>TOYOTA/LEXUS</b> 2003-11 4-Runner; 2003-12 Sequoia; 2003-12 Tundra; 2007-12 Tacoma; 2003-10 Land Cruiser; 2010 GX 460; 2004-10 GX 470; 2008-10 LX 570	31713	31867	
Husky Square to Flat T-Style Brake Control Adapter		31857	 31708
(with OEM specific under-dash connector & bare wires only for universal application to brake controls w/o a connector)	Part #		
Fits: • <b>CHEV/GMC/CADILLAC/HUMMER</b> 2003-06 Silverado; 2007 Silverado Classic; 2003-06 Suburban/Tahoe; 2003-06 Avalanche; 2003-06 Denali/Sierra; 2007 Sierra Classic; 2003-06 Yukon; 2003-06 Escalade; 2003-07 H2; 2005-07 H2 SUT	31691		
Fits: • <b>GM/CHEVY/BUICK/SATURN</b> 2007-12 Acadia; 2009-12 Traverse; 2008-12 Enclave; 2007-09 Outlook	31872		
Fits: • <b>DODGE/CHRYSLER</b> 1995-09 Ram Pickups; 1997-2011 Dakota; 1998-2009 Durango; 2007-09 Aspen	31687		
Fits: • <b>DODGE</b> 2010-12 Ram Pickups	31870		
Fits: • <b>DODGE</b> 2011-12 Durango	30011		
Fits: • <b>FORD</b> 1992-93 F-Series, Bronco	31688		
Fits: • <b>FORD</b> 2005-07 F-250/F-350; 2005-10 F-450/F-550	31694		
Fits: • <b>FORD</b> 2009-12 F-150; 2009-12 E-150/250/350	30009		
Fits: • <b>FORD</b> 2008-12 F-250/F-350	30013		
Fits: • <b>FORD/MERCURY/LINCOLN/LANDROVER</b> 1994-08 F-150; 1994-04 F-250/350; 1997-2011 Expedition; 1994-98 + 2003-08 Van (full size); 2000-05 Excursion; 1995-2003 Windstar; 2009-11 Flex; 2000-10 Explorer; 2000-11 Mountaineer; 1994-96 Bronco; 2005-11 Range Rover; 2005-10 LR3; 2010-11 LR4; 2007-08 Mark LT; 2010-12 MKT; 1998-2011 Navigator	31689		
Fits: • <b>HONDA</b> 2009-12 Pilot; 2006-12 Ridgeline	30010		
Fits: • <b>NISSAN/INFINITI</b> 2004-12 Armada/Titan; 2005-12 Frontier; 2004-11 QX-56; 2005-12 Pathfinder; 2004-08 Xterra; 2012 NV Van	31693		
Fits: • <b>TOYOTA/LEXUS</b> 2003-11 4-Runner; 2003-12 Sequoia; 2003-12 Tundra; 2007-12 Tacoma; 2003-10 Land Cruiser; 2010 GX 460; 2004-10 GX 470; 2008-10 LX 570	31697		



31689

Note: 2007 to present GMC / Chevy Vehicle applications do not provide a factory connector and the brake control must be hard wired to the vehicle pigtail located under the dash. This can be accomplished by removing the connector that is furnished with the brake control and butt connecting the 4 bare wires of the Brake Control to the bare wires on the vehicle pigtail.

## HUSKY BRAKE CONTROL SPECIFICATIONS



MODEL	QUEST®	ESCORT® DIGITAL	ESCORT®
SKU	W/Flat Connector: 31899	W/Flat Connector: 31898	31555
Activation	Inertia/Brake Pedal	Brake Pedal	Brake Pedal
Braking Algorithm	Accelerometer	Time Ramp	Time Ramp
Braking Application	Proportional/Progressive	Preset Braking	Preset Braking
Functional in Reverse	Proportional/Progressive	Preset Braking	Preset Braking
Braking Capacity	8	6	6
Braking Display	Digital	Digital	Multi-Color Bulb
Braking Output	% of Braking Capacity	% of Braking Capacity	Color = Braking Intensity
Mounting Angle			
Vertical Fore/Aft (Pitch)	360°	Unlimited	Unlimited
Horizontal Side-to-Side (Yaw)	±10°	Unlimited	Unlimited
Roll (Tilt)	±10°	Unlimited	Unlimited
Auto Leveling	Yes	Yes	Yes
Quick Release Bracket	No	No	No
Quick Connect Plug	Yes	Yes	No
Solid State Electronics	Yes	Yes	Yes
Slide Activates Brake Lights	Yes	Yes	Yes
Manual Operation	Vertical Slide	Vertical Slide	Vertical Slide
Diagnostics			
Reverse Polarity Protection	No	No	No
Trailer Side Short Protection	Yes	Yes	Yes
Trailer Light Continuity	Yes	Yes	Yes
Trailer Brake Failure Notification	Yes	Yes	No
Trailer Braking Types			
Electric	Yes	Yes	Yes
Electric/Hydraulic	No	Yes	No
Memory Pre-Sets	Last Setting	Last Setting	Last Setting
24 Volt Jump Start Protection	Yes	Yes	Yes
Custom Brake Settings	5	Fixed	Fixed
Warranty	Limited Lifetime	Limited Lifetime	Limited Lifetime

In Section N:	Hitches	Hitch Accessories	Car Towing	Levels	Mirrors & Safety	Brake Controls	Towing Electrical	Brake & Wheel	Automotive
---------------	---------	-------------------	------------	--------	------------------	----------------	-------------------	---------------	------------

## HUSKY Ascent Flexible Mount Proportional Trailer Brake Control

The revolutionary Husky Ascent features flexible mounting, so you can put your brake control components where you want them. The Heads Up Display can be dash mounted, rear view mirror mounted, or wherever it's convenient for you. The separate control can be placed in a handy location within easy reach. And the Ascent's Brain mounts completely out of sight. All three components simply plug in together for the ultimate in flexibility and safety. The Ascent keeps your eyes on the road and controls within reach. Advanced proportional technology gives you ultimate control over your towing experience by mirroring the braking of the tow vehicle. The Ascent's 8 brake capacity means you get short proof protection for up to 8 trailer brakes. Plus you get on-the-fly sensitivity adjustment with 7 settings for different loads and driving conditions. The Husky Ascent is also electric over hydraulic compatible, so it works with electric over hydraulic trailer brakes. Lifetime warranty.



Description	Part #
Ascent Brake Control with Connector	31624



**PROBLEM:** Truck interiors are more "car-like" making brake control installations more difficult. Drivers have to take their eyes off the road to find/read their controller. This is because the brake control display, controls and brain center are all located in a hard to see and reach area. But who says you have to have all 3 components in one box?

**SOLUTION:** The Husky Ascent has components that can be mounted where the driver really wants them with the flexible mounting innovation. The Heads Up Display helps keep your eyes on the road. The adjustment control is within easy reach. And you don't even see the Ascent's Brain of the system, because it can mount out of sight.



Display mounting options



Control mounting options

Multiple mounting possibilities for any make/model for added safety and convenience



### ASCENT BRAIN

- Inertia activation
- Dual-axis accelerometer braking application, proportional/progressive
- Provides braking even while in reverse
- 8 brakes/4 axles brake capacity
- Flexible mounting capability; can attach to multiple surfaces.
- 360° vertical mounting range
- 10° horizontal mounting range
- Includes quick connect plug
- Small profile mounts under dash



### ASCENT MANUAL BRAKE MECHANISM

- Slide activates brake lights
- Manual slide works with either right or left hand Nite-Glow/backlit slide, separate from the brain.
- 100% power on activation

### ASCENT HEADS UP DISPLAY

- 2 digit LED braking display is small, sleek, and elegant
- Mounts separate of the Brain
- Wires route up to corner of a pillar, so display is at the dash level
- Makes it easier to see without looking toward your knee
- Wires can be hidden from view
- Display is adjustable; orient it based on the vehicle and your height

# TRAILER CONNECTORS

In Section N:	Hitches	Hitch Accessories	Car Towing	Levels	Mirrors & Safety	Brake Controls	Towing Electrical	Brake & Wheel	Automotive
---------------	---------	-------------------	------------	--------	------------------	----------------	-------------------	---------------	------------

**OUR 4- & 5-WAY PLUGS ARE GENERAL PURPOSE PLUGS: MATCH PIN TO PIN FOR WIRE HOOK-UP.**



## 4-WAY ZINC HEAVY-DUTY TRAILER CONNECTORS

Heavy-duty for RVs and trucks. Latest die cast design. Extended socket exterior conceals terminals. Unique cable clamp prevents chafing, gives more cable support, saves installation time. Integral finger grips for positive pull. Spring-loaded cover. Dust, water resistant. Polarized.

color = limited supply

Available:	Car End + Trailer End Order #	Car End Only Order #	Trailer End Only Order #	Bracket Only, Zinc Order #	Bracket Only, Black Order #
<b>HUSKY ZINC CONNECTOR</b>					
Carded	N/A	14623	14624	14630	18046
Bulk	14620	14621	14622	14794	18048
Small Bracket, Carded					11952
<b>POLLAK ZINC CONNECTOR</b>					
Bulk	10195	10196		14794	
<b>CONNECTOR HARDWARE KIT</b>					<b>HARDWARE</b>
Kit includes (2) #8 x 1/2" self-drilling screws, (2) #10-32 x 1" mounting screws, plus all necessary hex nuts, lock washers, flat washers.					11859

## 4-WAY CHROME-PLATED TRAILER CONNECTORS



Polarized, chrome-plated housing and spring-loaded cover. High impact green Cyclocac insulators, split brass contacts. Mounting holes 1 3/4" on centers.

color = limited supply

Available:	Car End + Trailer End Order #	Car End Only Order #	Trailer End Only Order #	Bracket Only, Zinc Order #	Bracket Only, Black Order #
<b>HUSKY CHROME-PLATED CONNECTOR</b>					
Carded	15417	15418	15419	14630	18046
Bulk	14799	14801	14800	14794	18048
Small Bracket, Carded					11952
<b>POLLAK CHROME-PLATED CONNECTOR</b>					
Bulk (10219 and 10220 are LS)	10219	10221		14794	
<b>CONNECTOR HARDWARE KIT</b>					<b>HARDWARE</b>
Kit includes (2) #8 x 1/2" self-drilling screws, (2) #10-32 x 1" mounting screws, plus all necessary hex nuts, lock washers, flat washers.					11859

## 5-WAY TRAILER CONNECTORS

Polarized. Chrome-plated housing, spring-loaded cover. Durable interiors. Split brass contact for maximum current. Mounting holes 1 3/4" on centers. 6-24 volt, can also be used for intercom. Bulk packed.



5-WAY CONNECTOR	Car End Only	Trailer End Only	Bracket Only, Zinc	Bracket Only, Black
	Order #	Order #	Order #	Order #
Carded			14630	18046
Bulk	14804	14803	14794	18048
Small Bracket, Carded				11952
<b>CONNECTOR HARDWARE KIT</b>				<b>HARDWARE</b>
Kit includes (2) #8 x 1/2" self-drilling screws, (2) #10-32 x 1" mounting screws, plus all necessary hex nuts, lock washers, flat washers.				11859

## 4-WAY, 5-WAY & 6-WAY CONNECTOR ACCESSORIES



11859



# TRAILER CONNECTORS

**TOWING  
& SAFETY**

N

In Section N:	Hitches	Hitch Accessories	Car Towing	Levels	Mirrors & Safety	Brake Controls	Towing Electrical	Brake & Wheel	Automotive
---------------	---------	-------------------	------------	--------	------------------	----------------	-------------------	---------------	------------

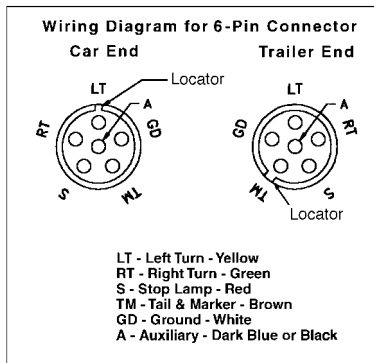

## 6-WAY METAL TRAILER CONNECTORS

Heavy-duty 6-way die cast connectors with rugged interiors. Unique cable clamp gives more support and helps save installation time. Features concealed terminal socket design, spring-loaded cover. Unit is dust and water-resistant.

color = limited supply

Available:	Car End + Trailer End	Car End Only	Trailer End Only	Bracket Only, Zinc	Bracket Only, Black
	Order #	Order #	Order #	Order #	Order #
<b>HUSKY 6-WAY METAL CONNECTOR</b>					
Carded	N/A	14628	14629	14630	18046
Bulk	14625	14626	14627	14794	18048
Small Bracket, Carded					11952
<b>POLLAK 6-WAY METAL CONNECTOR</b>					
Bulk	10207	10208			
<b>CONNECTOR HARDWARE KIT</b>					<b>HARDWARE</b>
Kit includes (2) #8 x 1/2" self-drilling screws, (2) #10-32 x 1" mounting screws, plus all necessary hex nuts, lock washers, flat washers.					11859



## HUSKY PRE-WIRED 6-WAY TO 4-WAY ZINC CONNECTOR

This pre-wired 6-way zinc connector would make any wiring job quicker and easier. The 4-way flat connects directly to your "T" connector. This leaves you with a ground wire to connect, which comes with a #10 ring terminal. Your brake and auxiliary wires come with 10/12 yellow butt connectors.

Available:	Car End Only	Trailer End Only	Bracket Only, Zinc	Bracket Only, Black
	Order #	Order #	Order #	Order #
<b>HUSKY PRE-WIRED ZINC 6-WAY TO 4-WAY CONNECTOR</b>				
Pre-Wired 12", Carded	10304		14630	18046
Pre-Wired 12", Bulk	18298		14794	18048
Pre-Wired 48", Bulk	10548		14794	18048
Small Bracket, Carded				11952
<b>CONNECTOR HARDWARE KIT</b>				<b>HARDWARE</b>
Kit includes (2) #8 x 1/2" self-drilling screws, (2) #10-32 x 1" mounting screws, plus all necessary hex nuts, lock washers, flat washers.				11859

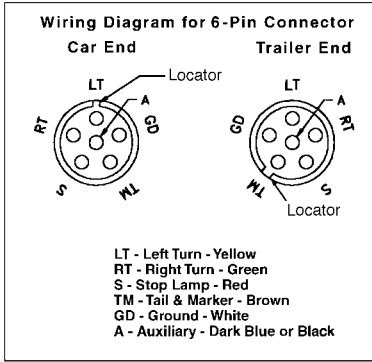

**HUSKY 6-WAY PLASTIC TRAILER CONNECTORS**

Recreational vehicle special. One piece black molded plastic socket (car end) with plated spring-loaded cover. Chrome-plated plug housing (trailer end). Interchangeable with other 6-way round pin connectors. Bulk packed.

6-WAY PLASTIC CONNECTOR	Car End Only	Trailer End Only	Bracket Only, Zinc	Bracket Only, Black
	Order #	Order #	Order #	Order #
Carded	11079	11078	14630	18046
Bulk	14798	14797	14794	18048
Small Bracket, Carded				11952
<b>CONNECTOR HARDWARE KIT</b>				<b>HARDWARE</b>
Kit includes (2) #8 x 1/2" self-drilling screws, (2) #10-32 x 1" mounting screws, plus all necessary hex nuts, lock washers, flat washers.				11859

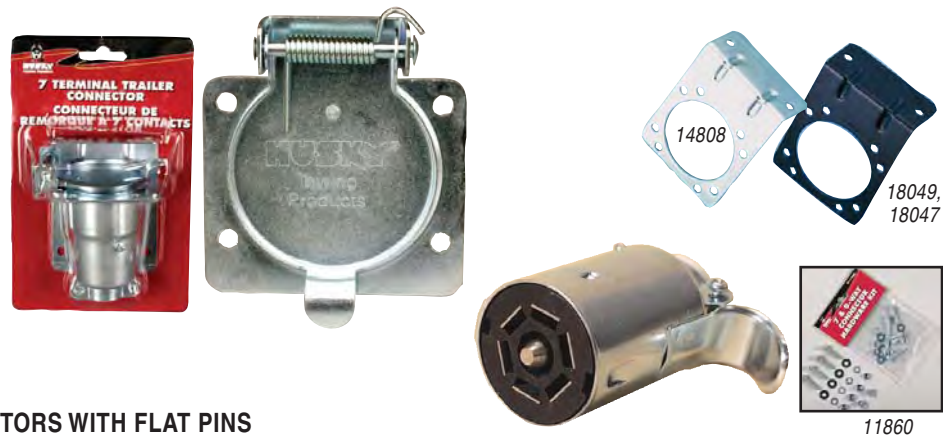
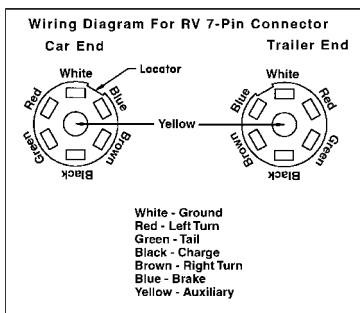

**7-WAY METAL TRAILER CONNECTORS WITH FLAT PINS**

7-way connectors are constructed from heavily plated metal for enhanced weather resistance. The spring-loaded cover, with its built-in safety latch, prevents damage from accidental disconnects. The trailer end comes with a large finger grip for easy use. Packaged car end includes a bracket.

Available:	Car End Only	Trailer End Only	Bracket Only, Zinc	Bracket Only, Black
	Order #	Order #	Order #	Order #
<b>HUSKY ZINC 7-WAY BLADE CONNECTOR</b>				
Carded (Car End packaged with Bracket)	14633	14634		18047
Bulk	14631	14632	14808	18049
<b>CONNECTOR HARDWARE KIT</b>				<b>HARDWARE</b>
Kit includes (2) #8 x 1/2" self-drilling screws, (2) #10-32 x 1" mounting screws, plus all necessary hex nuts, lock washers, flat washers.				11860

# TRAILER CONNECTORS

**TOWING  
& SAFETY**

N

In Section N:	Hitches	Hitch Accessories	Car Towing	Levels	Mirrors & Safety	Brake Controls	Towing Electrical	Brake & Wheel	Automotive
---------------	---------	-------------------	------------	--------	------------------	----------------	-------------------	---------------	------------

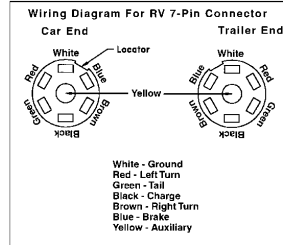

13795,  
13796

## HUSKY 7-WAY PLASTIC TRAILER CONNECTORS WITH FLAT PINS

7-way plastic connectors have a rust-free trailer connection with the thermoplastic 7-way connector. This connector, with its dual grip trailer end and self-locking lid, will give you years of trouble-free service. Packaged car end includes a bracket.

color = limited supply

Available:	Car End Only	Trailer End Only	Bracket Only, Zinc	Bracket Only, Black
	Order #	Order #	Order #	Order #
<b>HUSKY PLASTIC 7-WAY BLADE CONNECTOR</b>				
Bulk	14636	14637	14808	18049
<b>HUSKY PREMIUM 7-WAY BLADE CONNECTOR</b>				
• High impact nylon case • Socket cover features a gasket to protect against moisture • Nickel-plated pins for corrosion resistance • Fits both OEM and standard style mounting brackets				
Carded (Car End packaged with Bracket)	13796			18047
Bulk	13795		14808	18049
<b>CONNECTOR HARDWARE KIT</b>				<b>HARDWARE</b>
Kit includes (2) #8 x 1/2" self-drilling screws, (2) #10-32 x 1" mounting screws, plus all necessary hex nuts, lock washers, flat washers.				11860



## HUSKY PRE-WIRED 7-WAY TO 4-WAY PLASTIC CONNECTOR

7-WAY TO 4-WAY CAR END



13226,  
13227

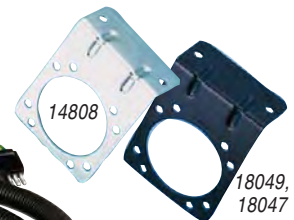

18049,  
18047

18299

13217

11860



Available:	Car End Only	Trailer End Only	Bracket Only, Zinc	Bracket Only, Black
	Order #	Order #	Order #	Order #
<b>HUSKY PRE-WIRED PLASTIC 7-WAY BLADE CONNECTOR</b>				
Pre-wired 7-way connector makes any wiring job quicker and easier. The 4-way flat connects directly to your "T" connector. This leaves you with a ground wire to connect, which comes with a #10 ring terminal and your brake, charge and backup wires which all come with 10/12 yellow butt connectors.				
Pre-Wired 12", Carded	10305			18047
Pre-Wired 12", Bulk	18299		14808	18049
Pre-Wired 48", Bulk	10547		14808	18049
Pre-Wired 60", Bulk	12484		14808	18049
<b>HUSKY EPOXY SEALED PRE-WIRED 7-WAY BLADE CONNECTOR</b>				
All wires and terminals are encapsulated with epoxy to form a weather tight, non-corrosive seal. 4-way flat connector plugs directly into existing 4-way flat connector on vehicle. Heavy duty harness consists of 10 gauge wires for the battery and ground, 12 gauge for auxiliary, and molded 4-way flat connector with 14 gauge wires. Nickel plated pins for corrosion resistance.				
Pre-Wired 12", Carded	13215			13226
Pre-Wired 60", Bulk	13216			13227
Pre-Wired 96", Bulk	13217			13227
<b>CONNECTOR HARDWARE KIT</b>				<b>HARDWARE</b>
Kit includes (2) #8 x 1/2" self-drilling screws, (2) #10-32 x 1" mounting screws, plus all necessary hex nuts, lock washers, flat washers.				11860



In Section N:	Hitches	Hitch Accessories	Car Towing	Levels	Mirrors & Safety	Brake Controls	Towing Electrical	Brake & Wheel	Automotive
---------------	---------	-------------------	------------	--------	------------------	----------------	-------------------	---------------	------------

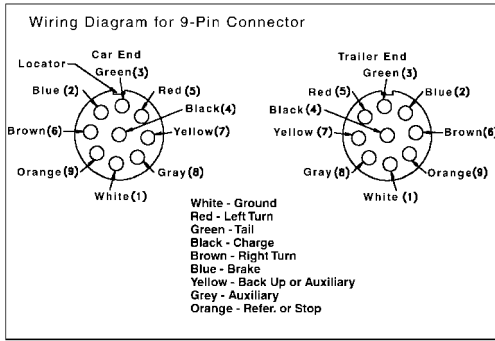

**HUSKY 9-WAY CONNECTORS**

Compact for easy location and mounting, heavy-duty screw machined contacts with longer engagement, spring loaded cover, self-draining socket on car side, and repairable. Meets or exceeds all new electrical requirements. Black plastic.

9-WAY CONNECTOR	Car End Only	Trailer End Only	Bracket Only (Zinc)	Bracket Only (Black)
	Order #	Order #	Order #	Order #
Carded	<b>11109</b>	<b>11105</b>		<b>18047</b>
Bulk	<b>14807</b>	<b>14806</b>	<b>14808</b>	<b>18049</b>
<b>CONNECTOR HARDWARE KIT</b>				<b>HARDWARE</b>
Kit includes (2) #8 x 1/2" self-drilling screws, (2) #10-32 x 1" mounting screws, plus all necessary hex nuts, lock washers, flat washers.				<b>11860</b>

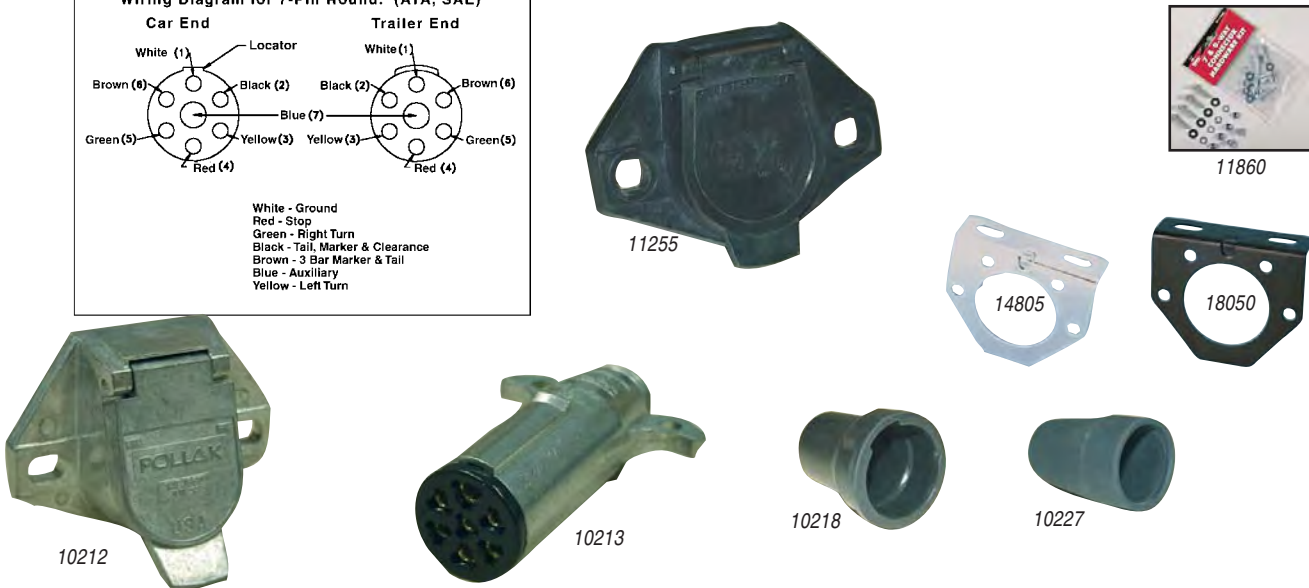
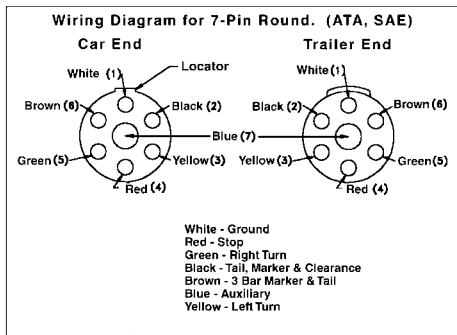

POLLAK 7-WAY CONNECTORS WITH ROUND PINS	ZINC ROUND-PIN CONNECTORS	GLASS-FILLED NYLON ROUND-PIN CONNECTORS
	Order #	Order #
Car End Only	<b>10212</b>	
Trailer End Only	<b>10213</b>	<b>11256</b>
6-Sided Bracket only, Zinc, Bulk	<b>14805</b>	<b>14805</b>
6-Sided Bracket only, Black, Bulk	<b>18050</b>	<b>18050</b>
Boot Only, Car End, Bulk	<b>10218</b>	<b>10218</b>
Boot Only, Trailer End, Bulk	<b>10227</b>	<b>10227</b>
Connector Hardware Kit	<b>11860</b>	<b>11860</b>

# TRAILER CONNECTORS

TOWING  
& SAFETY

N

In Section N:	Hitches	Hitch Accessories	Car Towing	Levels	Mirrors & Safety	Brake Controls	Towing Electrical	Brake & Wheel	Automotive
---------------	---------	-------------------	------------	--------	------------------	----------------	-------------------	---------------	------------

## HUSKY 6-Round and 7-RV Blade Connectors

Description	Part #
<b>6-Round Vehicle Connector</b>	
<ul style="list-style-type: none"> <li>• Oversized hinge for maximum durability.</li> <li>• Reinforced easy-grip lid opens 180 degrees for easier connections.</li> <li>• Best corrosion resistance.</li> <li>• Internal seals for ultimate weatherproofing.</li> <li>• Powder coated mounting bracket included.</li> </ul>	
LS 6-Round Vehicle Connector	17368
<b>6-Round Trailer Connector</b>	
<ul style="list-style-type: none"> <li>• Ergonomic Pistol Grip fits conveniently in your hand.</li> <li>• Die-cast zinc housing for increased durability.</li> <li>• Trailer side mounting bracket included.</li> <li>• Corrosion resistant terminals.</li> </ul>	
LS 6-Round Trailer Connector	17369
<b>7RV Blade Vehicle Side Connector</b>	
<ul style="list-style-type: none"> <li>• Oversized hinge for maximum durability.</li> <li>• Reinforced easy-grip lid opens 180 degrees for easier connections.</li> <li>• Best corrosion resistance.</li> <li>• Internal seals for ultimate weatherproofing.</li> <li>• Powder coated mounting bracket included.</li> </ul>	
7RV Blade Vehicle Side Connector	17370
<b>7RV Blade Trailer Side Connector</b>	
<ul style="list-style-type: none"> <li>• Ergonomic Pistol Grip fits conveniently in your hand.</li> <li>• Increased durability; corrosion resistant terminals.</li> <li>• Trailer side mounting bracket included.</li> <li>• Rear grommet seal for weatherproofing.</li> </ul>	
7RV Blade Trailer Side Connector	17371



## HUSKY 7-Way Trailer End Wiring Kits



Complete 7-way trailer end wiring kits to wire a trailer. Made from heavy duty rubber, kits come in 8' and 12' lengths to accommodate all trailer lengths. Complete kit saves time and money on installation. Primary wire gauges are 10-gauge (black, white), 12-gauge (blue), 14-gauge (brown, red, green, yellow). 7-way trailer connector fits with thermo-plastic or metal 7-way car end connectors.



Description	Part #
7-Way Female Connector with 8' Cable, Red Cover	19356
7-Way Female Connector with 12' Cable, Red Cover	19430

## HUSKY Coiled Wiring Harness with Connectors

Provides convenient electrical connection between motorhome and towed vehicle. Cable expands to over 8'. Vinyl coated cable is chemical resistant and waterproof. • The 4-wire cable has four 16-ga. wires; the 6-wire cable has four 16-ga. and two 14-ga. wires. • Includes both car end connectors and mounting brackets.

Towing Cable Kit, 1/Car	Part #
4-Way Coiled	13220
4-Way Straight	13492
6-Way Coiled	13221
6-Way Straight	13491



## JR PRODUCTS DELUXE CONNECTOR CLEANER

The easy to grip wood handle makes cleaning of most molded connectors effortless. High carbon bristles. Will not rust.

47178 Connector Cleaner  
#11000 6



14526 Connector Cleaner #01000 36



NEW!

## Husky 7-Pole Round Car End (Metal)



- Heavy-duty die-cast zinc design.
- Impact and corrosion resistant.

Description	Part #
Husky 7-Pole Round Car End (Metal)	30465



NEW!

30015,  
30063

## Husky 7 RV Blade Car End Connector

- Vehicle Side Socket.
- Impact and Corrosion Resistant.
- Rear grommet/ strain relief for weatherproofing.

Description	Part #
Husky 7 RV Blade (plastic) Car End connector, CD/1	30015
Husky 7 RV Blade (plastic) Car End connector, Bulk <i>(limited supply)</i>	30063

30135,  
30140

## Husky 7 RV Blade Trailer End Connector

- Trailer side plug.
- Impact and corrosion resistant.
- Easy-pull grip design.
- Rear grommet/ strain relief for weatherproofing..

Description	Part #
Husky 7 RV Blade (plastic) Trailer End connector, CD/1	30135
Husky 7 RV Blade (plastic) Trailer End connector, Bulk	30140



30485

NEW!

## Husky 5 Wire Flat Vehicle End

- 48" length.
- 5th wire provides back-up function on boat trailers releasing the surge brakes.
- Industry's best, 3 year warranty.
- Maximum durability, superior ergonomics.
- Easy-pull grip ease in connecting and disconnecting.
- Heavy duty connector housings with built-in mounting holes.
- Protective nylon wire sleeving and heat-shrink tubing.
- Includes molded-in dust cover, grease packet, and ground screw provided.

Description	Part #
Husky 5 Wire Flat (48") Vehicle End	30485



30486

## Husky 5 Wire Flat Trailer End

- 18" length.
- 5th wire provides back-up function on boat trailers releasing the surge brakes.
- Industry's best, 3 year warranty.
- Maximum durability, superior ergonomics.
- Easy-pull grip.
- Heavy duty connector housings with built-in mounting holes.
- Includes trailer side molded-in dust cover and grease packet.
- Protective nylon wire sleeving and heat-shrink tubing.

Description	Part #
Husky 5 Wire Flat (18") Trailer End	30486

# TRAILER CONNECTORS

TOWING  
& SAFETY

N

In Section N:	Hitches	Hitch Accessories	Car Towing	Levels	Mirrors & Safety	Brake Controls	Towing Electrical	Brake & Wheel	Automotive
---------------	---------	-------------------	------------	--------	------------------	----------------	-------------------	---------------	------------



NEW!

## Husky Ford / Chevy / GMC (OEM Replacement)

- Compatible with Ford, GM and other popular tow vehicles.
- Plug-In Simple!® for quick and easy installation or replacement.
- Durable lid opens 180 degrees.
- Ultimate weatherproofing.

Description	Part #
Husky Ford / Chevy / GMC (OEM Replacement)	30175



NEW!

## Husky 7 RV Blade Trailer End Connector (Metal) with Bracket

- Ergonomic pistol grip for easier handling.
- Ultimate weatherproofing protects connection.
- Includes terminal grease, mounting bracket & hardware.
- Die cast housing for ultimate durability.

Description	Part #
Husky 7 RV Blade Trailer End Connector (Metal) with Bracket	30499

## HUSKY Complete Trailer Wiring Kit

Save time and money with this Husky wiring kit. Everything you need to wire a vehicle requiring a 7-way connector and a dual battery isolator. No more searching for the right wire, terminals, hardware, etc. Package comes complete with a pre-wired plastic 7-way connector with the connecting butt connectors already installed. Plenty of wire and hardware to mount both the connector to the bracket, bracket to the vehicle, circuit breakers to the firewall, and wire ties to make it all look good.



Description	Part #
Wiring Kit	11751

## HUSKY 4-Way Round Wiring Harness

4-way round connector both ends, molded with 5' leads. Black.

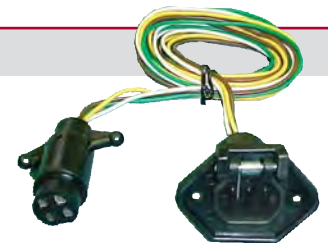

Description	Part #
4-Way Round Wiring Harness	11555



NEW!

## Husky 4 Wire Flat Extension (18" Length)

- Extends wiring system for more flexibility.
- Passes through vehicle ground.

Description	Part #
Husky 4 Wire Flat Extension (18" Length)	30170

In Section N:

Hitches

Hitch Accessories

Car Towing

Levels

Mirrors &amp; Safety

Brake Controls

Towing Electrical

Brake &amp; Wheel

Automotive

30487



## Husky 4 Wire Flat Vehicle End

- 48" length. • Includes terminal grease and ground screw.
- Ergonomic grip for easier handling. • Superior weatherproofing and durability.

Description	Part #
Husky 4 Wire Flat (48") Vehicle End	30487

30495



## Husky 4 Wire Flat Trailer End

- 12" length. • Easy pull grip. • Protective wire sleeving. • Heavy duty housing with built-in mounting holes. • Corrosion resistant terminals. • Includes dust cover and terminal grease packet for enhanced weatherproofing.

Description	Part #
Husky 4 Wire Flat (12") Trailer End	30495



## Husky 4 Wire Flat Trailer End with Y-Harness

- 20 ft length. • Wiring kit for re-wiring or new installs on trailers. • Wishbone design allows for the taillight brown wires to extend to both taillights. • Easy-pull grip. Ease in connecting/ disconnecting. Heavy duty connector housings with built-in mounting holes. • Protective nylon wire sleeving, heat-shrink tubing, and serrated ground terminal for proper grounding. • Includes molded-in dust cover and grease packet. Corrosion resistant tin-plated terminals. • Function printing on color-coded wires.

Description	Part #
Husky 4 Wire Flat Trailer End with Y-Harness (20')	30496

## HUSKY 4-Wire Flat Trailer Connectors

A 4-wire flat is the most commonly used trailer plug. This plug is found on small boat, utility, jet ski, snowmobile and small camper trailers.

Description	Part #
4-Wire Flat Connector, Car End, 12"	13190
4-Wire Flat Connector, Car End, 48"	13191
4-Wire Flat Connector, Trailer End, 12"	13192
4-Wire Flat Connector, Trailer End, 48"	13193

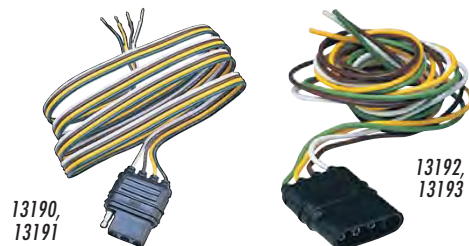

NEW!

## Husky 7 RV Blade and 6 Pole Round Mounting Bracket

- Works with all 7 RV Blade vehicle end sockets.
- Fits Multi-Tow® and Endurance™ 6 Pole Round vehicle end sockets..

Description	Part #
Husky 7 RV Blade and 6 Pole Round Mounting Bracket	30176

In Section N:	Hitches	Hitch Accessories	Car Towing	Levels	Mirrors & Safety	Brake Controls	Towing Electrical	Brake & Wheel	Automotive
---------------	---------	-------------------	------------	--------	------------------	----------------	-------------------	---------------	------------



30227

### Husky 4 Wire Flat Set (48" Vehicle End, 12" Trailer End) with Splices

- 48" Vehicle and 12" Trailer End. • Includes 6 splice connectors. • Wire functions printed on wire for easy reference. • Corrosion resistant terminals. • Meets SAE standards.



**HUSKY**  
TOWING PRODUCTS

Description	Part #
Husky 4 Wire Flat Set (48" Vehicle End, 12" Trailer End) with Splices	30227

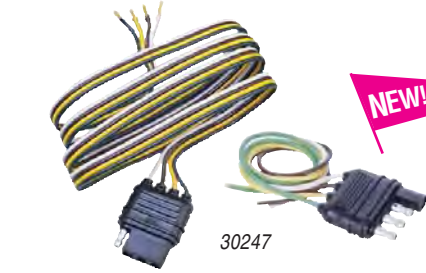

30247

NEW!

### Husky 4 Wire Flat Set (48" Vehicle End, 12" Trailer End)

- 48" Vehicle and 12" Trailer End. • Corrosion resistant terminals. • Wire functions printed on wire for easy reference. • Meets SAE standards.

Description	Part #
Husky 4 Wire Flat Set (48" Vehicle End, 12" Trailer End)	30247



NEW!

### Husky 2 Pole In-line Set

- Contains matched set positive/negative male and female connectors. • Corrosion resistant tin-plated terminals and rear protective boot. • Easy install to rear of connector. • 5/16" distance between terminals.

Description	Part #
Husky 2 Pole In-line Set	30258

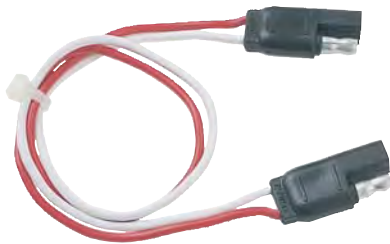

NEW!

### Husky 2-Pole Flat Extension (12")

- Connector 12" length. • Corrosion Resistant Terminals.

Description	Part #
Husky 2-Pole Flat Extension (12")	30259

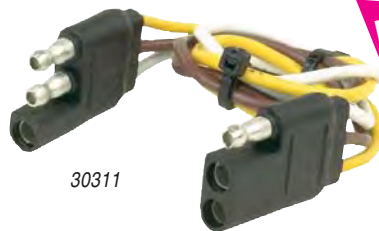

NEW!

30311

### Husky 3 Pole Flat Extension (12")

- Multi-use, male and female connectors. • 2 function wires with 1 ground wire.

Description	Part #
Husky 3 Pole Flat Extension (12"), Pk/1	30268
Husky 3 Pole Flat Extension (12"), Bulk	30311



NEW!

### Husky 4 Wire Flat Tester Keychain

- LED indicator lights test left/right turn, brake and taillight. • Red LED lights will glow if connection is correct when the function is activated.

Description	Part #
Husky 4 Wire Flat Tester Keychain	30178



## Husky 4 Wire Flat Extension (12")

- Extends wiring system for more flexibility. • 12" length.
- Corrosion resistant terminals. • Meets SAE standards.

Description	Part #
Husky 4 Wire Flat Extension (12"), PK/1	30280
Husky 4 Wire Flat Extension (12"), Bulk	30312



## Husky 2 Pole Flat Extension (12" Length)

- Multi-Use positive/negative mating connectors.
- Corrosion resistant tin-plated terminals. • 16 gauge copper wire.

Description	Part #
Husky 2 Pole Flat Extension (12" Length)	30310

## HUSKY Quick-Fix™ Flat Trailer Connector

- Repairs / replaces damaged 4-flat. • Matched set (vehicle and trailer). • No external splices to create corrosion point. Easy to install:
- 1- Cut off damaged 4-wire flat. 2- Insert wires into Quick-Fix Flat. 3- Compress internal splices. • Connect vehicle to trailer AND GO!

Description	Part #
Quick-Fix 4-Wire Flat Set	15180



## HUSKY 5-Way Flat Connector

11970 is a connector with 48" wire leads. Carded. 11588 is an extension, with a male connector on one end and a female on the other.

Description	Part #
5-Way Connector with 4' Wire Leads	11970
Male/Female 2' 5-Way Extension	11588

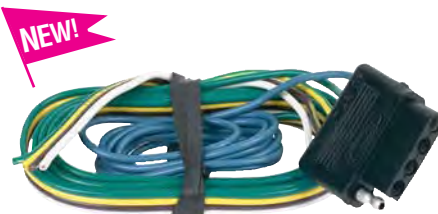
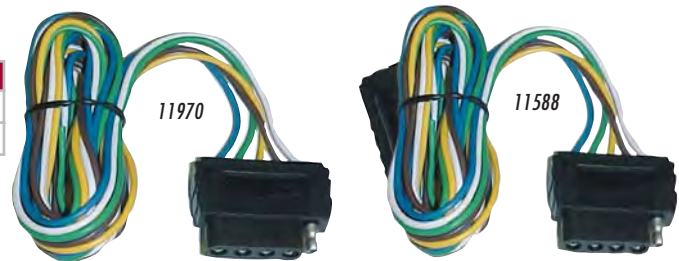

## Husky 5 Wire Flat (48" Length)

- Corrosion Resistant Terminals.
- For use with marine trailers equipped with surge brakes.

Description	Part #
Husky 5 Wire Flat Extension (48" Length)	30427

# TRAILER CONNECTORS

**TOWING  
& SAFETY**

**N**

In Section N:	Hitches	Hitch Accessories	Car Towing	Levels	Mirrors & Safety	Brake Controls	Towing Electrical	Brake & Wheel	Automotive
---------------	---------	-------------------	------------	--------	------------------	----------------	-------------------	---------------	------------



## POLLAK U.S. CAR 7-WAY CONNECTOR KIT

Includes **11775** Socket and Bracket, Interlocking Connector. With 0.5" convoluted tubing and RV standard color coded leads. Forms a weather tight, non-corrosive assembly. For new installation, replacement of aftermarket or OEM's. With all hardware and installation instructions.

**11771** With 48" Harness #11-898 10



## POLLAK SEALED 7-WAY TWIST & LOCK RV CONNECTOR SOCKET

- Easy to install with a twist and lock assembly on factory installed brackets and hitches.
- Solves corrosion problems and eliminates rusting.
- Features high-impact nylon shell, stainless steel spring and rubber gasket to guarantee against moisture intrusion when closed.
- Socket lid also has a drain slot and is angled down for drainage.
- Wiring diagram on lid facilitates installation.
- Fits GM style and various Nissan models.

**16865** RV OEM Style, 7-Way Socket #11-916P (PACKAGED) 1



## OPTRONICS TRUNK & TRAILER CONNECTORS

Trailer connectors, trunk connectors and harness extensions with trailer connector on one end and trunk connector on opposite end.

**11983** 4-Way to Bare Wire, 48" Length, Clam pack #A-48TC 12

**12046** 5-Way to Bare Wire, 48" Length, Clam pack #A-485TC 12



## HUSKY MAG-FLAT MAGNETIC BRACKET

Keeps 4-wire flat out of harm's way. Attaches to any metal surface.

**15179** Mag-Flat Magnetic Bracket #178-38095 10



## 4-WAY TRUNK/ TRAILER KIT

4-pole flat type connector with leads. Molded, polarized plugs and color coded wires.

Molded 4-Way Trailer Harness:

**11260** <sup>LS</sup> 5' Loop #B6004F PKG/1 25

**11676** 24' Loop, includes 8 wire connectors #2506F 6



## THE BEST CONNECTION LIGHT CONNECTING KIT

Replace present stop and tail-light bulb in vehicle with this light connector kit. No splicing necessary.

**11514** Light Connect Kit #2560F 6

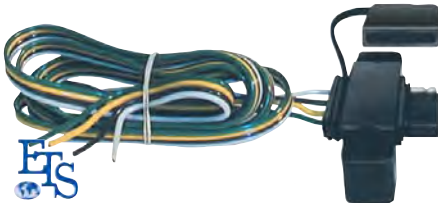

## ETS HEAVY DUTY VEHICLE 4-WAY FLAT CONNECTOR/BACKET/CAP

One piece molded vehicle 60" 4-way connector, bracket and weather cap is easily mounted under hitch crossbar or bumper and includes hardware kit and instructions.

**17861** 4-Way Flat with Bracket, Packaged #CB-1860-HK 1



## ETS MOLDED CONNECTORS

Flat Type Connector with 12" Loop, Bulk

**10200** <sup>LS</sup> 3-Pole #1203 BULK 25

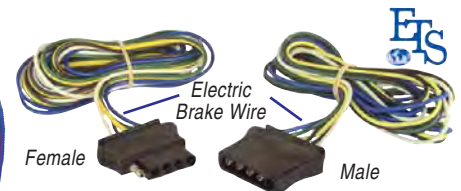

## ETS HEAVY DUTY 5-WAY FLAT VEHICLE/TRAILER CONNECTOR

Heavy duty 5-way flat vehicle/trailer connectors with 60" 16-gauge bonded SAE color coded wire featuring electric brake circuit blue wire for newer trailer applications.

**12205** Trailer End #H6005F-MB 25

**12206** Car End #H6005F-FB 1

## ETS 4-WAY CIRCUIT TESTER, LED

4-way flat male connector circuit tester plugs into vehicle female end connector indicating whether wiring is properly operating through LEDs. The circuit tester can also verify correct installation of vehicle tail lighting converter applications.

**16413** <sup>LS</sup> Tester only #BCT4F-M PKG/1 25

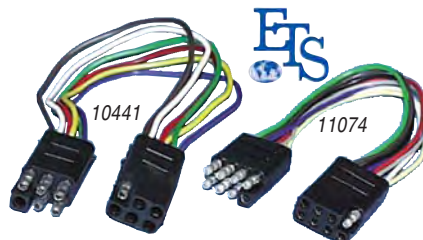

Square Type Connector with 12" Loop, Bagged:

**10685** 6-Pole #B1206 PKG/1 25

Square Type Connector with 12" Loop, Bulk:

**10441** 6-Pole #1206 BULK 25

**11074** 8-Pole #1208 BULK 25



## 6-WAY SQUARE CONNECTOR WITH 5' LEADS

Molded rubber 6-way connector. Color-coded harness. 5' leads.

**12889** 6-Pole Square #B6006 PKG/1 25



## CONNECTOR ADAPTERS

In Section N:

Hitches

Hitch Accessories

Car Towing

Levels

Mirrors &amp; Safety

Brake Controls

Towing Electrical

Brake &amp; Wheel

Automotive



### Husky Flex Adapter 6 Pole Round to 4 Wire Flat

- LED test lights. • Verifies electrical continuity. • Flexible wire provides larger turning radius. • Includes dust cover and grease packet to protect terminals.

Description	Part #
Husky Flex Adapter 6 Pole Round to 4 Wire Flat	<b>30466</b>



NEW!

### Husky Flex Adapter 7 RV Blade to 4 Wire Flat

- Provides for flexible reach. • Includes function testing LEDs. • Easy-pull grip design. • Dust cover and protected wire for added durability.

Description	Part #
Husky Flex Adapter 7 RV Blade to 4 Wire Flat	<b>30468</b>
Husky Flex Adapter 7 RV Blade to 5 Wire Flat.	<b>30473</b>



NEW!

### Husky Multi-Tow® 7 RV Blade to 6, 5 and 4 Way

- Patented Quick-Change™ plug quickly accommodates both 6 pole wiring codes.
- Multi-Tow® Adapter provides four different trailer towing options from a single device.
- Overbuilt hinge, lid, and connector housings provide maximum durability.
- Impact and Corrosion resistant. Tin-plated terminals with terminal grease packet provided.
- Plug-In Simple!® Eliminates rewiring vehicle or trailer. No Cutting, No Splicing.

Description	Part #
Husky Multi-Tow® 7 RV Blade to 6, 5 and 4 Way	<b>30484</b>

### Husky Multi-Tow® Connector 7 RV Blade, 5 & 4 Wire Flat

- Provides multiple towing options from one connector. • Reinforced easy-grip lid opens 180° for easier connections. • Internal seals for ultimate weatherproofing. • Long life oversized hinge. • Mounting bracket, hardware and terminal grease packet included.

Description	Part #
Husky Multi-Tow® Connector 7 RV Blade, 5 & 4 Wire Flat	<b>30498</b>

## HUSKY Specialty Adapter Expansion

Eliminates rewiring vehicle or trailer. • **Husky 7-Pin to 7RV Adapter**—Designed for tow vehicles with a 7-pin connector and adapts to trailers equipped with a 7RV Blade connector. Flexible wire provides extra reach. • **Husky 7-Pin to 6-Round Adapter**—Designed for tow vehicles with a 7-pin connector and adapts to trailers equipped with a 6-way round connector.



Description	Part #
Husky 7-Pin to 7RV Adapter	<b>15253</b>
Husky 7-Pin to 6-Round Adapter	<b>15258</b>

# CONNECTOR ADAPTERS

**TOWING  
& SAFETY**

N

In Section N:	Hitches	Hitch Accessories	Car Towing	Levels	Mirrors & Safety	Brake Controls	Towing Electrical	Brake & Wheel	Automotive
---------------	---------	-------------------	------------	--------	------------------	----------------	-------------------	---------------	------------

## HUSKY Adapter: Multi-Tow™ 7:4

Application for millions of recent towing vehicles! Replaces factory 7-way!

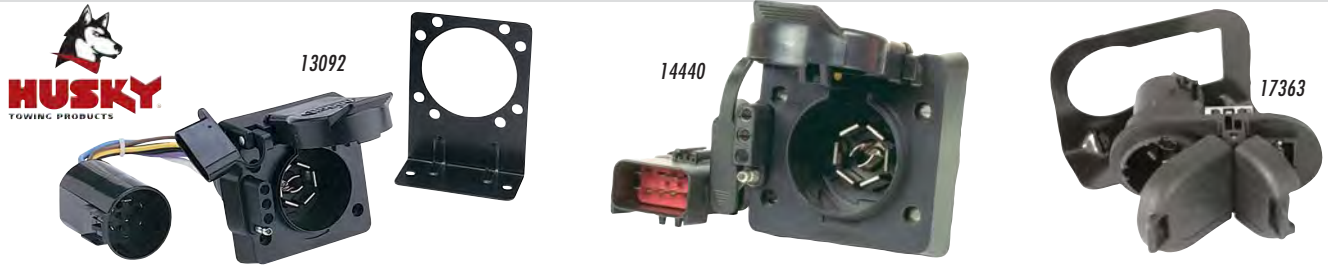

7:4 MULTI-TOW ADAPTERS (PROVIDES 7 RV BLADE AND 4-WIRE FLAT TOWING)	Part #
<p><b>Multi-Tow Adapter 13092 (7:4)</b> fit the following: <b>AUDI</b>—Q7 (w tow pkg) 2007 - 2010; Q5 (w/tow pkg.) 2009 - 2010. <b>BUICK</b>—Enclave (w/ tow pkg) 2008 - 2012; Rainier 2004 - 2007. <b>CADILLAC</b>—Escalade 2002 - 2011; Escalade EXT 2002 - 2011. <b>CHEVROLET</b>—Avalanche 2002 - 2012; Express Van (w/tow pkg) 2003 - 2012; Colorado (w/ tow pkg) 2008 - 2012; Silverado 1500 2003 - 2012; 2500/3500 (New body style) 1999 - 2012; Suburban 2000 - 2012; Tahoe 2000 - 2012; Trailblazer 2002 - 2009; Traverse (w/ tow pkg) 2010 - 2011. <b>CHRYSLER</b>—Aspen (w/ factory 7-way) 2007 - 2009. <b>DODGE</b>—Ram Pickup (w/ factory 7-way) 2010 - 2012; Durango (w/ tow pkg) 2007 - 2009; Nitro (w/ factory 7-way) 2007 - 2012. <b>FORD</b>—Econoline Van (w/ factory 7 way) 2004 - 2012; Excursion 2000 - 2005; Expedition (w/ factory 7 way) 1999 - 2011; Explorer (w/ factory 7-way) 2002 - 2012; Explorer Sport Trac (w/ factory 7-way) 2007 - 2010; F-150 (w/ factory 7-way) 1999 - 2011; F-250 Heavy Duty, F-350 (w/ factory 7-way) 1999 - 2012; Flex (w/tow pkg) 2009 - 2012. <b>GMC</b>—Savanna Van (w/tow package) 2009 - 2012; Acadia (w/ factory 7-way) 2007 - 2012; Denali (w/ factory 7 way) 2001 - 2012; Envoy (w/ tow pkg) 2002 - 2009; Sierra 1500 (new body style) 2003 - 2012; Sierra 2500/3500 (new body style) 1999 - 2012; Yukon 2000 - 2012; Yukon XL 2000 - 2012; Canyon w/ tow pkg only 2008 - 2011. <b>HUMMER</b>—H2 2003 - 2009; H2 SUT 2005 - 2009; H3 2006 - 2009; H3T SUT 2009 - 2009. <b>INFINITI</b>—QX56 (w/ tow pkg.) 2004 - 2012. <b>ISUZU</b>—Ascender 2004 - 2008. <b>JEEP</b>—Liberty (w/ factory 7-way) 2008 - 2010. <b>KIA</b>—Borrego 2009 - 2009. <b>LINCOLN</b>—Aviator (w/ factory 7-way) 2003 - 2006; Mark LT2006 - 2008; MKT (w/tow pkg) 2010 - 2011; Navigator (w/ factory 7 way) 1999 - 2012. <b>MERCEDES BENZ</b>—M Class (w/tow pkg) 1998 - 2005; M Class (w/tow pkg) 2009 - 2010; M Class (w/tow pkg) 2006 - 2008. <b>MERCURY</b>—Mountaineer (w/ factory 7 way) 2002 - 2010. <b>NISSAN</b>—Armada 2004 - 2012; Titan 2004 - 2011. <b>OLDSMOBILE</b>—Bravada 2002 - 2004. <b>SAAB</b>—9-7X 2005 - 2010. <b>SATURN</b>—Outlook (w/ factory 7 way) 2007 - 2009. <b>TOYOTA</b>—Sequoia (w/ tow pkg) 2011 - 2012.</p>	<b>13092</b>
<p><b>Multi-Tow Adapter 14440 (7:4)</b> fits the following: <b>CHRYSLER</b>—Pacifica (w/ factory 7-way) 2003 - 2008; Aspen (w/ tow pkg) Early 2007 - 2007. <b>DODGE</b>—Ram Van 2001 - 2003; Ram Pickup 2500/3500 (w/ tow pkg) 2000 - 2009; Dakota (w/ factory 7-way) 2000 - 2010; Durango (w/ tow pkg) 2005 - 2006; Durango (w/ tow pkg) early 2007 - 2007; Ram Pickup (w/ factory 7-way) 2000 - 2009; Sprinter (w/ factory 7-way) 2004 - 2008; Sprinter 3500 2009 - 2009; Sprinter 2500 2009 - 2009. <b>JEEP</b>—Wrangler (w/ factory 7-way) 2004 - 2010; Commander (w/ factory 7-way) 2006 - 2010; Grand Cherokee (w/ factory 7-way) 2000 - 2010; Liberty (w/ factory 7-way) 2004 - 2007. <b>MERCEDES BENZ</b>—GL Class (w/tow pkg) 2007 - 2010. <b>MITSUBISHI</b>—Raider (w/ factory 7-way) 2006 - 2008.</p>	<b>14440</b>
<p><b>Multi-Tow Adapter 17363 (7:4)</b> fits the following: <b>AUDI</b>—Q5 (w/tow pkg.) 2009 - 2010; Q7 (w tow pkg) 2007 - 2010. <b>BUICK</b>—Enclave (w/ tow pkg) 2008 - 2012; Rainier 2004 - 2007. <b>CADILLAC</b>—Escalade 2002 - 2011; Escalade EXT 2002 - 2011. <b>CHEVROLET</b>—Traverse (w/ tow pkg) 2010 - 2011; Express Van (w/tow pkg) 2003 - 2012; Avalanche 2002 - 2012; Colorado (w/ tow pkg) 2008 - 2012; Silverado 1500 2003 - 2012; 2500/3500 (New body style) 1999 - 2012; Suburban 2000 - 2012; Tahoe 2000 - 2012; Trailblazer 2002 - 2009. <b>CHRYSLER</b>—Aspen (w/ factory 7-way) 2007 - 2009. <b>DODGE</b>—Ram Pickup (w/ factory 7-way) 2010 - 2012; Durango (w/ tow pkg) 2007 - 2009; Nitro (w/ factory 7-way) 2007 - 2012. <b>FORD</b>—Excursion 2000 - 2005; Expedition (w/ factory 7 way) 1999 - 2011; Explorer (w/ factory 7-way) 2002 - 2012; Explorer Sport Trac (w/ factory 7-way) 2007 - 2010; F-150 (w/ factory 7-way) 1999 - 2011; F-250 Heavy Duty, F-350 (w/ factory 7-way); 1999 - 2012; Flex (w/tow pkg) 2009 - 2012; Econoline Van (w/ factory 7 way) 2004 - 2012. <b>GMC</b>—Acadia (w/ factory 7-way) 2007 - 2012; Canyon w/ tow pkg only 2008 - 2011; Denali (w/ factory 7 way) 2001 - 2012; Envoy (w/ tow pkg) 2002 - 2009; Sierra 1500 (new body style) 2003 - 2012; Sierra 2500/3500 (new body style) 1999 - 2012; Yukon 2000 - 2012; Yukon XL 2000 - 2012; Savanna Van (w/tow package) 2009 - 2012. <b>HUMMER</b>—H2 2003 - 2009; H2 SUT 2005 - 2009; H3 2006 - 2009; H3T SUT 2009 - 2009. <b>INFINITI</b>—QX56 (w/ tow pkg.) 2004 - 2012. <b>ISUZU</b>—Ascender 2004 - 2008. <b>JEEP</b>—Liberty (w/ factory 7-way) 2008 - 2010; Grand Cherokee (w/ tow pkg) 2011 - 2011. <b>KIA</b>—Borrego 2009 - 2009. <b>LINCOLN</b>—Aviator (w/ factory 7-way) 2003 - 2006; Mark LT2006 - 2008; Navigator (w/ factory 7 way) 1999 - 2012; MKT (w/tow pkg) 2010 - 2011. <b>MERCEDES BENZ</b>—M Class (w/tow pkg) 1998 - 2005; M Class (w/tow pkg) 2006 - 2008; M Class (w/tow pkg) 2009 - 2010. <b>MERCURY</b>—Mountaineer (w/ factory 7 way) 2002 - 2010. <b>NISSAN</b>—Armada 2004 - 2012; Titan 2004 - 2011. <b>OLDSMOBILE</b>—Bravada 2002 - 2004. <b>SAAB</b>—9-7X 2005 - 2010. <b>SATURN</b>—Outlook (w/ factory 7 way) 2007 - 2009. <b>TOYOTA</b>—Sequoia (w/ tow pkg) 2011 - 2012.</p>	<b>17363</b>
Bracket Only for 17363	<b>19909</b>

## HUSKY Adapter: Multi-Tow™ 7:4

Provides 7-way RV blade or 4-wire flat towing, both from one location. Weatherproof design. Plugs into a 4-wire flat on the tow vehicle. Mounting bracket and hardware included.



Description	Part #
Multi-Tow 7:4	<b>13165</b>

## HUSKY Adapter: 7 RV to 6 & 4 Multi-Tow™

7-way RV blade to BOTH 6-round and 4-wire flat adapter with dust cover. On 13176, the center pin is auxiliary, and the universal center pin can be switched to electric brake. On 13177, the center pin is for the electric brake, and the universal center pin can be switched to auxiliary.



7-Way RV Blade to 6 Round & 4 Flat Adapter	Part #	
Center Pin Auxiliary	13176	
Center Pin Electric Brake	13177	

## HUSKY Adapter: 7 RV to 6 & 4 Multi-Tow™ with Nite-Glow

Plug-In Simple!® Adapter, 7 RV blade to 6-pole round and 4-wire flat. Center pin auxiliary on 6-pole round. Switchable to electric brake. Adapts to tow multiple trailers. Glows upon taillight activation. Helps find your connection in the dark



7-Way RV Blade to 6 Round & 4 Flat Adapter	Part #	
Multi-Tow Adapter, 7 RV to 6 Round and 4 Wire Flat with Nite Glow	15326	

## HUSKY Flex-Coil™ & LED Adapters with Nite-Glow™

Flex-Coil Adapters provide the user with increased durability and additional length that may be necessary to reach the tow vehicle's socket and the trailer/towed vehicle's plug. In addition, Flex-Coil adapters with Nite-Glow™ illuminate upon activation of the taillight function. This enable the user to find the electrical connection in the dark and show that the vehicle's trailer wiring system is functioning properly.

Description	Part #	
<b>Flex-Coil Adapter with Nite-Glow</b>		
• 3 ft. stretch. • Increased weather proofing. • Tin plated terminals. • Easy grip connectors. • Heavy-duty cable.		
7-Way RV Blade to 4-Wire Flat Nite-Glow	15181	



### Husky Flex-Coil™ Adapters with Nite-Glow™

- Nite-Glow™ illuminates on taillight function verifying continuity.
- Stretches to 8 feet. • Easy-grip, heavy-duty connectors with heavy-duty cable.

Description	Part #	
Husky Flex-Coil™ Adapter, 7 RV Blade to 4 Pole Round with Nite-Glow™	30500	
Husky Flex-Coil™ Adapter, 7 RV Blade to 6 Pole Round with Nite Glow™.	30501	

**NEW!**

# CONNECTOR ADAPTERS

TOWING  
& SAFETY

N

In Section N:	Hitches	Hitch Accessories	Car Towing	Levels	Mirrors & Safety	Brake Controls	Towing Electrical	Brake & Wheel	Automotive
---------------	---------	-------------------	------------	--------	------------------	----------------	-------------------	---------------	------------

## BRAKEBUDDY DINGHY TOW WIRING KITS (SPECIALTY ADAPTERS)

### ENDURANCE™ FLEX-COIL™ 7 RV BLADE TO 4 POLE ROUND WITH NITE-GLOW™

Nite-Glow™ illuminates on taillight function verifying continuity. Stretches to 8 feet. Includes 4 round socket and mounting bracket. Easy-grip, heavy-duty connectors with heavy-duty cable.

**31626** 7 RV Blade to 4 Pole Round with Nite-Glow  
#39744 2



### ENDURANCE™ FLEX-COIL™ 4 POLE ROUND TO 4 POLE ROUND WITH NITE-GLOW™

Nite-Glow™ illuminates on taillight function verifying continuity. Stretches to 8 feet. Includes 4 round sockets and mounting brackets. Easy-grip, heavy-duty connectors with heavy-duty cable.

**31627** 4 Pole Round to 4 Pole Round with Nite-Glow  
#39746 2



### ENDURANCE™ FLEX-COIL™ 7 RV BLADE TO 6 POLE ROUND WITH NITE-GLOW™

Nite-Glow™ illuminates on taillight function verifying continuity. Stretches to 8 feet. Includes 6 round socket and mounting bracket. Easy-grip, heavy-duty connectors with heavy-duty cable.

**31628** 7 RV Blade to 6 Pole Round with Nite-Glow  
#39754 2

### ENDURANCE™ FLEX-COIL™ 6 POLE ROUND TO 6 POLE ROUND WITH NITE-GLOW™

Nite-Glow™ illuminates on taillight function verifying continuity. Stretches to 8 feet. Increased weatherproofing. Includes 6 round sockets and mounting brackets. Easy-grip, heavy-duty connectors with heavy-duty cable.

**31629** 6 Pole Round to 6 Pole Round with Nite-Glow  
#39756 2



### DINGHY TOW STRAIGHT WIRE 7 RV BLADE TO 6 ROUND

72" long. Includes 6 round vehicle socket and mounting bracket. Easy-grip, heavy-duty connectors with heavy-duty cable.

**31630** 7 RV Blade to 6 Round #39757 2



### DINGHY TOW STRAIGHT WIRE 7 RV BLADE TO 4 ROUND

72" long. Includes 4 round vehicle socket and mounting bracket. Easy-grip, heavy-duty connectors with heavy-duty cable.

**31631** 7 RV Blade to 4 Round #39747 2



## POLLAK 7-WAY POWER OUTLET ADAPTER

- Adapts the 7-way trailer connector at the rear of the vehicle to a 12V plug or DC-AC converter 110V plug outlet.
- Manufactured from high-impact nylon.
- Terminal pins are tinned copper.
- Lets you plug in your DC-AC converter 110V outlet to provide access to power for such accessories as TV, electric cooler, portable work light, or power tools.
- Or plug in the 12V plug from your coffee pots, air pumps, 12V lights, etc. to use them while outside the vehicle.

**19208** LS External Power Adapter #11-896 1



optronics

## OPTRONICS 5-7 WAY ADAPTER

Converts tow vehicle 7-way round blade connector to 5-way flat pin connector.

**12149** 5-Flat to 7-Round Adapter Wired, Clam pack #A-57WH 6



## HUSKY Plug-In Solution LED Adapters

Husky's L.E.D. vehicle-to-trailer adapter series incorporates built-in trouble-shooting. If the trailer lights are not functioning correctly, you can isolate the problem by simply looking at the adapter. If the lights on the adapter are functioning, it's a trailer-side problem. If the lights are not functioning, the problem is with the vehicle.



Description	Part #
<b>LED Adapter</b>	
7-Way RV Blade to 4-Wire Flat (Includes function testing LED's!)	15174

## HUSKY Plug-In Solution 4-Wire Flat to 5-Wire Flat Adapter

Adapts vehicles with 4-wire flat to trailers with surge brakes and/or 5-wire flat connection.

Description	Part #
4-Wire Flat to 5-Wire Flat	15175



## HUSKY Connector Adapters

Take the guesswork and frustration out of vehicle-to-trailer wiring with Husky Connector Adapters.

Description	Part #
<b>HUSKY ADAPTER: 7-WAY BLADE RECEPTACLE</b>	
(A) Adapts 7-Way Blade (RV) to 5-Way and 4-Way Flat, Each	14437
(B) Adapts 7-Way Blade (RV) to 4-Way Flat, with flexible wires and dust cover, Each	13170
Husky trailer wiring systems take the guesswork and frustration out of vehicle-to-trailer wiring. Pre-wired adapters give you a means to create a custom wiring system appropriate for any Husky Plug-In Solution towing situation.	
(C) Adapts 4-Wire Flat to 7-Way Blade (RV), Plastic, Each	13166
(D) Adapts 7-Way Blade RV to 7-Way Pin Type (flexible)	13064
<b>HUSKY ADAPTER: 6+7-WAY ROUND (PIN TYPE)</b>	
(E) Adapts 6-Way Round to 4-Way Flat Adapter, with flexible wires, Each	13168
<b>HUSKY ADAPTER: 4 TO 4</b>	
(F) Adapts 4-Way Round to 4-Way Flat Adapter, with flexible wires and dust cover, Each	13173
(G) 4-Wire Flat Knockout Adapter for use with 1.25" hole diameter, or with 4, 6, 6-pole knockout mounting bracket	13102



# CONNECTOR ADAPTERS

In Section N:	Hitches	Hitch Accessories	Car Towing	Levels	Mirrors & Safety	Brake Controls	Towing Electrical	Brake & Wheel	Automotive
---------------	---------	-------------------	------------	--------	------------------	----------------	-------------------	---------------	------------



## Husky 7 RV Blade to 4 Wire Flat Adapter

- Includes dust cover.
- Impact and corrosion resistant.
- Ergonomic one-piece design enhances weatherproofing.

Description	Part #
Husky 7 RV Blade to 4 Wire Flat Adapter.	<b>30313</b>



## Husky 7 RV Blade to 6 Pole Round (center pin auxiliary) Adapter

- Includes dust cover.
- Impact and corrosion resistant.
- Easy-pull grip and corrosion resistant tin-plated terminals.
- Universal center pin can be switched to auxiliary or electric brake.

Description	Part #
Husky 7 RV Blade to 6 Pole Round (center pin auxiliary) Adapter	<b>30314</b>



## Husky 6 Pole Round to 4 Wire Flat Adapter

- Includes dust cover.
- Impact and corrosion resistant.
- Easy-pull grip design.

Description	Part #
Husky 6 Pole Round to 4 Wire Flat Adapter	<b>30315</b>



## Husky 7 Pole Round to 4 Wire Flat Adapter

- Impact and corrosion resistant.
- Easy-pull grip design.
- Includes dust cover.

Description	Part #
Husky 7 Pole Round to 4 Wire Flat Adapter	<b>30341</b>

## Husky 7 RV Blade to 5 Wire Flat Adapter

- Impact and corrosion resistant.
- For use with marine trailers equipped with surge brakes.
- Includes dust cover.

Description	Part #
Husky 7 RV Blade to 5 Wire Flat Adapter	<b>30692</b>



## Husky 6 Pole Round to 7 RV Blade Adapter

- Die-cast zinc for durability (6 Pole Round).
- Flexible wire provides extra reach.
- Corrosion resistant terminals.

Description	Part #
Husky 6 Pole Round to 7 RV Blade Adapter	<b>30693</b>



Packaged

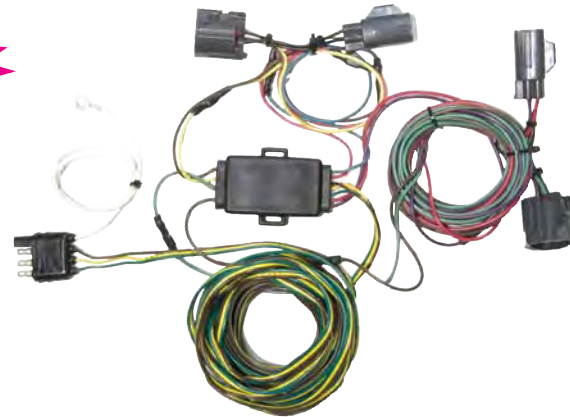

Plug-in Simple  
Towed Vehicle Wiring Kit  
(Vehicle specific)



## BRAKEbuddy TOWED VEHICLE WIRING KITS

- Towed Vehicle Wiring Kits makes wiring a tow vehicle easy!
- No Cutting! No Splicing! Saves Time! Plugs directly into vehicle OEM wiring system.
- Added Safety! Notifies other drivers by powering taillights and turn signals on the towed vehicle.
- Isolates Towed Vehicle! Integrated diodes protect motorhome.
- All Popular applications available! Our applications cover a wide range of towed vehicles.

Plug-in Simple Towed Vehicle Wiring Kit (...continued), Packaged:

### CHEVROLET

- 30768** Chevrolet Cobalt 2dr, Chevrolet HHR, Pontiac G5 2dr, Pontiac G5 GT 2dr, Pontiac Pursuit 2dr 2005-10 #39700 1
- 30769** Chevrolet Avalanche 2002-06; Chevrolet Silverado/GMC Sierra 2003-06; Chevrolet Silverado/GMC Sierra 2007-11; Chevrolet Silverado classic/GMC Sierra classic 2007; Chevrolet Suburban/GMC Yukon Denali 2003-06; Chevrolet Tahoe/GMC Yukon 2003-06 #39701 1
- 30834** Chevrolet Tahoe, Suburban, Avalanche, GMC Yukon, Suburban (4 pin connector) 2007-11 #39702 1
- 30854** Chevrolet Tahoe, Suburban, Avalanche GMC Yukon, Suburban (5 pin connector) 2007-11 #39703 1
- 30863** Chevrolet Tahoe, Suburban, Avalanche GMC Yukon, Suburban (6 pin connector) 2007-11 #39704 1
- 30881** Chevrolet Malibu (except LTZ), Chevrolet Traverse 2008-11 #39706 1
- 30891** Chevrolet Equinox, GMC Terrain 2010-11 #39708 1
- 30904** Chevrolet Colorado, GMC Canyon, Isuzu 350 2004-11 #39709 1

### FORD

- 30694** Ford Escape 2008-12; Ford Edge, Lincoln MKX 2007-10; Ford F-150 2009-11; Ford Ranger STX 2005-11 #39600 1
- 30696** Ford Edge 2011-12 #39601 1
- 30730** Ford Edge, Lincoln MKX 2011-12 #39602 1

### HONDA

- 31129** Honda CR-V 2007-11 #39900 1
- 31135** Honda Fit 2009-11 #39902 1

### JEEP

- 30908** Jeep Wrangler 2007-11 #39800 1  
S/O Jeep Wrangler 1996-04 #39801  
S/O Jeep Wrangler 2005-06 #39802  
S/O Jeep Liberty 2002-07 #39803
- 31032** Jeep Liberty 2008-11 #39804 1
- 31033** Jeep Commander 2006-10 #39805 1  
S/O Jeep Grand Cherokee (Early 2007) 2005-07 #39806
- 31107** Jeep Grand Cherokee (Late 2007) 2007-11 #39807 1

### MAZDA

- 30694** Mazda Tribute 2008-11 #39600 1

### SATURN

- 31130** Saturn Outlook 2007-10 #39901 1
- 31149** Saturn Vue 2008-10 #39903 1



Universal  
Towed Vehicle Wiring Kit  
(Fits all towed vehicles)

- 31642** Fits ALL Towed Vehicles #39599 1

Plug-in Simple Towed Vehicle Wiring Kit,  
Packaged:

### BUICK

- 30881** Buick Enclave 2008-11 #39706 1

### CADILLAC

- 30769** Cadillac Escalade 2002-06 #39701 1
- 30876** Cadillac Escalade 2007-11 #39705 1

In Section N:	Hitches	Hitch Accessories	Car Towing	Levels	Mirrors & Safety	Brake Controls	Towing Electrical	Brake & Wheel	Automotive
---------------	---------	-------------------	------------	--------	------------------	----------------	-------------------	---------------	------------

## HUSKY Plug-In Fifth Wheel Wiring Harness

Quickly wire your fifth wheel trailer with the Husky Plug-In Fifth Wheel Wiring Harness. The modular system plugs together to accommodate most vehicle and trailer combinations. It's easy: just select the correct wiring kit, locate the factory OEM tail-light wiring harness on the tow vehicle, unplug the wiring harness and simply plug in the Husky connector. This unit will be pre-wired to provide Right Turn, Left Turn, and Tail-Light function. 10' L wire for fifth wheel installations for all wires; includes 12 gauge wires for electric brakes and auxiliary power lead.

Description	Part #
<b>5th Wheel Wiring Harness</b> Fits Chevy/GMC Pickup 1500, 2500/3500 00-11 w/Tow Pkg	<b>13100</b>



**NEW!**

## Husky Harness Adapter: Dodge / Chrysler / Jeep OEM Quick-Install™ Wiring Kit

- Allows for Dodge trucks to adapt to the Quick-Install™ 7 RV Blade.
- Reinforced lid opens 180 degrees to prevent breaking.
- Ultimate weatherproofing.

Description	Part #
Husky Harness Adapter OEM Quick-Install Wiring Kit, fits the following: <b>CHRYSLER</b> —Aspen (w/ tow pkg) Early 2007; Pacifica (w/ factory 7-way) 2003 - 2008. <b>DODGE</b> —Ram Van 2001 - 2003; Sprinter (w/ factory 7-way) 2004 - 2008; Ram Pickup 2500/3500 (w/ tow pkg) 2000 - 2009; Sprinter 2500 2009 - 2009; Durango (w/ tow pkg) 2005 - 2006; Sprinter 3500 2009 - 2009; Ram Pickup (w/ factory 7-way) 2000 - 2009; Dakota (w/ factory 7-way) 2000 - 2010; Durango (w/ tow pkg) early 2007 - 2007. <b>JEEP</b> —Commander (w/ factory 7-way) 2006 - 2010; Grand Cherokee (w/ factory 7-way) 2000 - 2010; Liberty (w/ factory 7-way) 2004 - 2007; Wrangler (w/ factory 7-way); 2004 - 2010. <b>MERCEDES BENZ</b> —GL Class (w/tow pkg) 2007 - 2010. <b>MITSUBISHI</b> —Raider (w/ factory 7-way) 2006 - 2008.	<b>30406</b>

## TOWDADDY™ WIRING HARNESSES

TowDaddy™ Wiring Harnesses help quickly wire your towed vehicle for towing. They connect both tail and brake lights in addition to amber turn signals (unlike most other methods) keeping your towed vehicle legal. They eliminate the need to install or replace additional lightbulbs. They also eliminate the need for a brake light relay kit or a "stop switch" kit. Your car is also "prewired" for a supplemental brake system. OEM kits come with vehicle specific connectors. The universal kit fits all vehicles, but requires some connections.

Check [www.towdaddy.com](http://www.towdaddy.com) for new applications.



OEM WIRING HARNESS



UNIVERSAL WIRING HARNESS KIT FITS ALL TOWED VEHICLES

**32035** All towed vehicles, All years  
#10000 10

### OEM WIRING HARNESSES APPLICATION CHART

- 32025** Jeep Rubicon 2007-2011, Jeep Wrangler 2007-2012 #1001 10
- 32026** Jeep Wrangler 1998-2004 #1002 10
- 32027** Jeep Liberty 2002-2007 #1003 10
- 32028** Chevrolet Cobalt (2-Door) 2005-2010, Chevrolet HHR 2006-2011, Pontiac G5 (2-Door) 2007-2009, Pontiac G5 Pursuit 2DR 2005-2009 #3002 10
- 32029** Chevrolet Cobalt (4-Door) 2005-2010, Pontiac G5 (4-Door) 2007-2009 #3003 10

- 32030** Buick Enclave 2008-2012, Chevrolet Malibu (No LTZ) 2008-2011, Chevrolet Traverse 2009-2012 #3006 10
- 32031** Ford Edge 2007-2010, Ford Edge Sport 2009-2010, Ford Escape 2008-2012, Ford Freestar 2004-2007, Lincoln MKX 2007-2010, Mazda Tribute 2008-2011, Mercury Mariner 2008-2011, Mercury Monterey 2004-2007 #3007 10
- 32032** Dodge Nitro 2007-2011, Jeep Liberty 2008-2012 #3008 10
- 32033** Jeep Grand Cherokee 2007-2012 #3011 10
- 32034** Honda CRV 2007-2011 #3012 10



## HUSKY FIFTH WHEEL HARNESSES

Easily route towing electrical functions into the truck bed while retaining electrical functions at the rear of the vehicle.

## Husky Fifth Wheel Harnesses

Easily route towing electrical functions into the truck bed for 5th wheel trailers, while retaining electrical functions at the rear of the vehicle.



Description	Part #
Chev/GMC/Ford/Dodge/Nissan/Toyota 1500 / 2500 / 3500 Pickups 2000-12; F-150 / 250 / 350 2008-12; Ram 1500 (w/ tow package) 2010-12; Ram 2500 / 3500 (w/ tow package) 2010; Titan 2004-12; Tundra (w/ tow package) 2010-12.	30342
Dodge Ram 1500/2500/3500 2000-2009 (with factory r RV Blade).	30345
Chevy/GMC/Ford/Dodge/Nissan/Toyota 1500 / 2500 / 3500 Pickups 2000-11; F-150 / 250 / 350 2008-12; Ram 1500 (w/ factory 7 RV Blade) 2010-11; Titan 2004-10; Tundra (w/ tow package) 2010-11.	30392

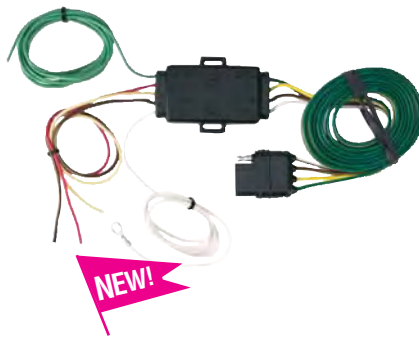

## Husky LED Compatible Taillight Converter

- 72" length.
- Electronic Taillight Converter adapts tow vehicles taillight system to the trailer's.
- Powers up to 2.1 amps per output.
- Double-molded weatherproof design, includes dust cover.
- Converter mounts in trunk out of harm's way.
- Corrosion resistant terminals.
- Compatible with LED lights on vehicle.

Description	Part #
Husky LED Compatible Taillight Converter	30428

## HUSKY Power Tail-Light Converters

These units completely isolate the tow vehicle from trailer malfunctions. Power is taken directly from the battery for isolation and brighter trailer tail-lights. Each unit can power up to 3 sets of stop/turn signals (8.0 amps) on the trailer. For vehicles equipped with independent bulb turn signals and brake lights or common bulb systems.



Description	Part #
<b>HUSKY POWER TAIL-LIGHT CONVERTER (RELAY SYSTEM)</b>	
Provides isolation needed to bypass sensitive vehicle electronics. Can power up to 8.0 amps per output.	
Power Tail-Light Converter	13162
<b>HUSKY SHORT-PROOF POWER TAIL-LIGHT CONVERTER</b>	
Recommended universal converter application. Short circuit protected. Can power up to 8.0 amps per output. Protects tow vehicle electronics and itself from wiring shorts. Self-resetting.	
Short-Proof Converter	13163

# TAILLIGHT CONVERTERS • DIODES

**TOWING  
& SAFETY**

**N**

In Section N:	Hitches	Hitch Accessories	Car Towing	Levels	Mirrors & Safety	Brake Controls	Towing Electrical	Brake & Wheel	Automotive
---------------	---------	-------------------	------------	--------	------------------	----------------	-------------------	---------------	------------

## HUSKY Electronic Tail-Light Converters

Electronic tail-light converters adapt an independent bulb tail-light system of the tow vehicle to the common bulb tail-light system of the trailer. Each unit can power 2.1 amps per stop/turn signal.



**HUSKY**  
TOWING PRODUCTS

Description	Part #
<b>HUSKY TAIL-LIGHT CONVERTER, 48"</b>	
Recommended for repairing damaged tail-light converter.	
48" Converter	<b>13186</b>
<b>HUSKY VEHICLE TOWING VEHICLE TAIL-LIGHT ISOLATING KIT</b>	
Permanently installs on towed vehicle near tail-lights.	
Tail-Light Converter/Isolator, 23' L	<b>13189</b>



## HUSKY Premium Tail Light Isolators

Provides a safe and convenient way to use factory lights on towed vehicles while protecting sensitive electronics from voltage feedback.

- Permanently installs on tow vehicle, near tail lights.
- Heavy duty, 30-amp rating.
- Aluminum heat sink prevents diode failure caused by overheating.
- Easy installation: includes connectors and adhesive mounting pad.

Description	Part #
Husky Tail Light Isolator (Diode), 1/Card	<b>39869</b>
Husky Tail Light Isolators (Diodes), 2/Card	<b>39870</b>
Husky Tail Light Isolators (Diodes), 3/Card	<b>39871</b>
Husky Tail Light Isolators (Diodes), 25/Box	<b>39868</b>
<b>Premium Parking Light Isolator</b>	
Allows use of towed vehicle's lights. Prevents feedback between RV and car. If the towed vehicle's lights are turned on while still plugged into the motorhome, the motorhome will draw from the towed vehicle to supply power to all of the park lights. This will place a heavy load on the towed vehicle's wiring, and can result in severe electrical system damage. Using the Husky Parking Light Isolator will prevent this, while still allowing the motorhome to power the towed vehicle's park/tail lights. • Permanently installs on tow vehicle near tail lights. • Heavy duty, 30-amp rating. • Aluminum heat sink prevents diode failure caused by overheating. • Easy installation: includes connectors and adhesive mounting pad.	
Parking Light Diode, 1/Card	<b>39867</b>
<b>Tail Light Isolator Wiring Kit</b>	
Recommended installation kit for Husky Premium Taillight Isolators. • Use the towed vehicle's light system for towing. • Permanently installs on towed vehicle. • 26' of 16 gauge ribbon wire with 4-way flat connector. • Includes wire, connectors and installation hardware. <i>Diode kits sold separately.</i>	
Wiring Kit for Isolator, 1/Card	<b>13984</b>
<b>Tail Light Isolator Wiring Kit with Bulbs</b>	
Isolated, internal light system for towing. Eliminates cutting into factory wires. • Use this kit in place of tail light isolators. • Permanently installs on towed vehicle. • Fits most vehicles with clearance in taillight housing. • 26' of 16 gauge ribbon wire with 4-way flat connector. • Easy installation includes wires, connectors, bulbs, sockets, installation hardware and instructions.	
Tail Light Wiring Kit, 1/Card	<b>13985</b>
<b>Tow Bar Wire Harness</b>	
Recommended for all tow bars. 80" long with 4-pin flat connectors. • Permanently installs on tow bar. • Easy installation. • Includes wire ties.	
Tow Bar Wiring Harness, 1/Card	<b>13986</b>
<b>Tow Bar Wiring Kit</b>	
Recommended installation kit for Husky Premium Tail Light Isolators. • Permanently installs on towed vehicle. • Includes 26' of 16 gauge wire. • Easy installation includes, cables, connectors and installation hardware.	
Tow Bar Wiring Kit, 1/Card	<b>13987</b>



39869



39870



39871



39868



39867



13984



13985



13986

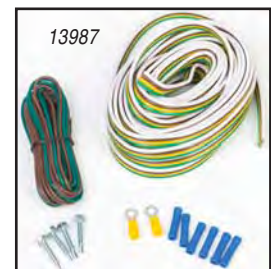

13987