

VENTMATE VENT COVERS

VENTS & TRIM

H

In Section H: Roof Ventilation Refrigerator Vents Plumbing Vents Registers & Grilles Side Vents Trim/Molding Gutter Extensions



LET'S FRESH AIR CIRCULATE, KEEPS WEATHER OUT!



67311 Silver

67310 White

67312 Champagne

67313 Black

67314 Smoke

VENTMATE INCLUDES UNIVERSAL RUBBER ROOF KIT #65213

VENTMATE VENT SYSTEM

- Increased Air Flow
- Aerodynamic Design
- 5 Year Warranty
- Easy Installation, Hardware Included
- Available in various colors.

Matches both White and Smoke vent lids from VentMate or CP Products for Jensen, Elixir or Ventline.

Ventmate Vent System, Each:

- 67313** Black #67313 5
- 67312** Champagne #67312 5
- 67311** Silver #67311 5
- 67314** Smoke #67314 5
- 67310** White #67310 5



65213

VENTMATE DRILLING JIG

Make installation of Ventmate vent hoods even faster and easier with the drilling jig. Simply place the jig over the vent and drill holes using the heat-treated guides on the jig. Fits most major brands of 14" x 14" vents. The zinc chromate plating provides durable, long-lasting protection against rust.

65681 LS Drilling Jig #65681 1



VENTMATE RUBBER ROOF MOUNTING KIT

Mounts to the side of most popular 14" x 14" roof vents. Eliminates the need to remove existing vent mounting screws while also eliminating the need to drill holes in the roof. Works with all VentMate vent hoods.

65213 New Style Rubber Roof Mounting Kit, Bulk #65213 5

VENTMATE REPLACEMENT VENT LIDS

Fit 14" x 14" plastic frame vents. Sold and packaged two ways: individually in a box with graphics or bagged with a header card.



REPLACEMENT LIDS FOR PRE-1995 JENSEN STYLE VENTS

Standard Lid for Jensen Style Vents

Color	Box/1	Bag/1	Price
White	61628	63110	
Smoke	61629	63112	
Amber	61630	63111	
Lifetime Warranty Lid			
White	65487		

61628, 63110

61630, 63111

61629, 63112

Jensen Pre-1995 Style hinge, plastic

Jensen 1995+ Style hinge, plastic



65487 Lifetime

REPLACEMENT LIDS FOR HENG'S & 1995+ JENSEN STYLE VENTS

Standard Lid for Heng's & 95+ Jensen Style Vents

Color	Box/1	Bag/1	Price
White	69282	69284	
Smoke	69283		
Lifetime Warranty Lid			
White	69285		

Note when replacing Heng's smoke vent lids: Ventmate Smoke lids will fit Heng's vents but the colors are not an exact match.



Boxed Vent Lids

NEW!

69282, 69284

69285 Lifetime



65489 Lifetime

LIDS FOR OLD-STYLE (PRE-'95) ELIXIR VENTS

Lid for Pre-95 Elixir Vents

Color	Box/1	Bag/1	Price
White	61634	63116	
Smoke	61635	63118	
Amber	61636	63117	
Lifetime Warranty Lid			
White	65489		

61636, 63117

61635, 63118

61634, 63116

Pre-95 Elixir hinge style

VENTMATE REPLACEMENT VENT LIDS

VENTS & TRIM



In Section H:	Roof Ventilation	Refrigerator Vents	Plumbing Vents	Registers & Grilles	Side Vents	Trim/Molding	Gutter Extensions
---------------	------------------	--------------------	----------------	---------------------	------------	--------------	-------------------

VENTMATE REPLACEMENT VENT LIDS

Fit 14" x 14" plastic frame vents. Sold and packaged two ways: individually in a box with graphics or bagged with a header card.



LOW PROFILE REPLACEMENT LIDS FOR VENTLINE, 1995+ ELIXIR AND HENG'S UNIVERSAL VENTS

Low profile lid. For Ventline vents with a 12 volt fan, use item **64961**.

Low Profile Lid for Ventline, 1995+ Elixir and Heng's Universal Vents

Color	Box/1	Bag/1	Price
White	61255	63113	
Smoke	61271	63115	
Amber	61258	63114	
Lifetime Warranty Lid			
White	69281		



61255, 63113



61258, 63114

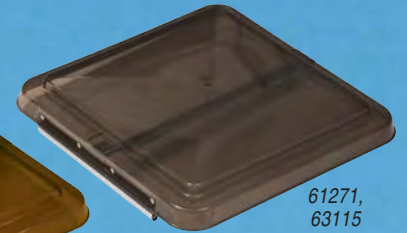

61271, 63115

STANDARD PROFILE REPLACEMENT LIDS FOR VENTLINE, 1995+ ELIXIR AND HENG'S UNIVERSAL VENTS

Standard profile lid.

Standard Profile Lid for Ventline, 1995+ Elixir and Heng's Universal Vents

Color	Box/1	Bag/1	Price
White	69280	69278	
Smoke	69279		
Lifetime Warranty Lid			
Hi-Dome style to fit over large fan.			
White	65479		



Metal hinge for Ventline & 1995+ Style Elixir, Heng's Universal



Boxed Vent Lids



69280, 69278



65479 Lifetime



Hi-Dome Profile



VENTMATE LIFETIME WARRANTY REPLACEMENT VENT LIDS

Never buy another vent lid! Impact resistant and UV stabilized. Works on 14" x 14" power vents with 12V fans.

Lifetime Warranty Ventlid, White:

65487 Fits Old (Pre-1995) Jensen-Style #65487 **12**

69285 Fits Heng's & 1995+ Jensen-Style #69285 **500**

65489 Fits Pre '95 Elixir #65489 **12**

65479 Fits Ventline/ '95+ Elixir Hi-Dome Style to fit over large fan #65479 **12**

69281 Fits Ventline/ '95+ Elixir Low Profile #69281 **500**

The Original!

MAXAIR®

- America's first choice for RV Ventilation
- Protects your RV's interior from rain
- Constant airflow prevents heat build-up, lets musty air, smoke and cooking odors escape
- Proven, super-tough one piece design
- Mounts to all standard roof vents
- **6-year warranty**, best in the industry*



The Original mounts on most popular 14" x 14" standard roof vents, and features our exclusive Zero-Leak Mounting System that eliminates the need to drill any holes in your RV's roof surface. Six-year Limited Warranty. 19.5" L x 18.5" W x 9" H.

*Warranty limited to repair or replacement, see vendor's website for details.

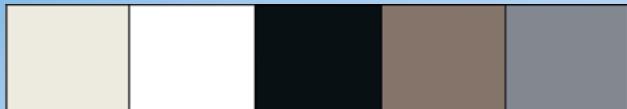

Almond White Black Smoke Gray

- 64643 White #00-933066 10
- 64644 Smoke #00-933067 5
- 64645 Shell White (Almond) #00-933068 10
- 65772 Black #00-933069 10
- 66566 Gray #00-933070 5

Accessory - Allows vent cover to easily open for cleaning

- 66570 Hinged Vent Cover Bracket #00-225001 12

MAXAIR II

More Vent Area than any Other Cover

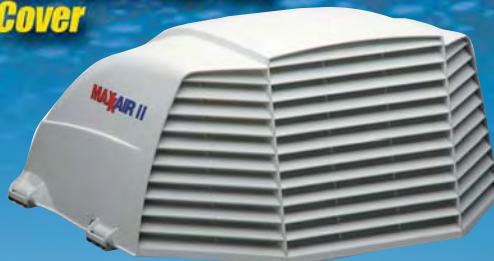

- Twice as much vent area as our original vent cover
- Solid one-piece, sleek aerodynamic design
- Hinged hardware included for easy opening and cleaning
- **6-year warranty**, best in the industry*

Opening for Cleaning a Breeze



Stainless steel snap lock pins remove for easy access. Hinged brackets provide full access for cleaning and inspection of roof vent seal.

Now the new MaxxAir II, available in four popular colors, with twice the vent area and with hinged hardware included, is an even better value. Six-year Limited Warranty. 22.125" Length x 20.25" Wide x 9.5" Height.

*Warranty limited to repair or replacement, see vendor's website for details.

- 67277 White #00-933072 5
- 67278 Smoke #00-933073 5
- 67279 Almond #00-933074 5
- 67280 Black #00-933075 5

FAN/MATE®

New & Improved!

RAIN COVER FOR HIGH-POWERED CEILING FANS

New louvers with protective galvanized screen provide superior rain protection and the new Fan/Mate for 2011 now includes hinged opening mounting brackets to allow for cleaning and servicing of your fan. The Fan/Mate 950 includes the same features as the Model 850 but is colored BLACK to accent custom painted RVs. Fan/Mate® is designed for use with high-powered ceiling fans such as Fan-Tastic™, Comfort Air™, or Northern Breeze™. The Fan/Mate® completely encloses your ceiling fan/vent allowing your fan/vent to open for ventilation, providing excellent rain protection for your RV interior. Both models feature a high-strength polyethylene cover with UV inhibitors, designed for years of service. Three-year Limited Warranty. 32.5" L x 20.5" x 9.93"H.



- Model 850 (White) and Model 950 (Black) feature a 20 % larger vent area for better fan performance
- Both models have protective exhaust screen and louvers
- Both models feature hinge opening mounting brackets that provide easy access for cleaning and service

- 69251 Model 950 Black #00-945004 1
- 69252 Model 850 White #00-945003 1

MAXFAN[®]

The RV Ventilation Solution

Standard Model

Deluxe Model

With Built-In Rain Cover!

NEW!



Both models are available as Manual Opening or Remote Control Opening



NEW! Easy to Read Remote Control

- Remote control models now include controls at ceiling - **A MaxxFan Exclusive!**
- Fan runs with lid closed to circulate air (Ceiling Fan Mode)
- Lid Available in White or Smoke
- Flush mounted, easy to clean Keypad, controls fan speed, thermostat, air intake and exhaust
- Features a powerful 10-speed fan motor
- Provides over 900 Cubic feet of air per minute to keep you cool and comfortable
- Installs into all standard 14" x 14" RV roof openings
- 2-YEAR Limited WARRANTY with Lifetime Limited WARRANTY on lid.

Standard Models

- 69857** White Lid, Manual Opening #00-0400K 1
- 69858** Smoke Lid, Remote Opening #00-04500K 1

Deluxe Models

- 69203** White Lid, Manual Opening #00-05100K 1
- 69232** Smoke Lid, Manual Opening #00-06200K 1
- 69204** White Lid, Remote Opening #00-07000K 1
- 69233** Smoke Lid, Remote Opening #00-07500K 1

TURBO/MAXX[®]

All the benefits of a Vent Cover - Plus a fan!

- NEW!** • Features hinge opening mounting brackets that provide easy access for cleaning and service
- Control console at ceiling provides 3 speed fan motor operation with intake and exhaust functions
- Thermostat model provides automatic operation
- Large 12" diameter, 10-blade fan prevents heat build-up, odors and musty air
- 2-year Limited warranty
- Powerful 12-volt, 4-amp motor provides more than 900 CFM on highest speed



MaxxAir's Turbo/Maxx[®] provides maximum ventilation even when it rains. Remove stinky air, smoke and cooking odors while preventing heat build-up. The Model 1200T WITH THERMOSTAT allows the fan to cycle on and off when you're gone. Simply adjust the thermostat to your desired temperature. The Turbo/Maxx[®] attaches directly to your existing 14" x 14" standard roof vent. Both models feature a white, high density polyethylene rain cover with UV inhibitors. Two-year Limited Warranty.

- 61895** 1200T With Thermostat #00-965001 1
- 64920** 3550 No Thermostat #00-965007 1

WINDOW/MAXX[®]

Louvered Window Vent



Provides refreshing cross ventilation. Ideal ventilation for pets. Mounts to left or right hand sliders up to 33" tall. Window fully opens and closes as before.

- 61497** Window/Maxx #00-455000 6

ZERO LEAK KIT. Original Hardware Kit for re-installation of the original MaxxAir Vent Cover. Mounts to the vent side wall to avoid drilling holes in your roof. Stainless steel and aluminum. Not to be used for Fan/Mate, Turbo/Maxx or MaxxAir II.

- 65252** Zero Leak Kit #00-225000 5

MaxxAir products are protected by U.S. Patent Nos. 7,004,832; 5,309,972; 5,672,101; 5,897,435; D.376,007; D.330,415; D.320,267; D.391,632; D463,541 S and other Patents Pending. Fan-Tastic Vent™ is a registered trademark of Fantastic Vent Corp. Coleman is a registered trademark of the Coleman Co., Inc. Comfort Air is a registered trademark of SHURflo, LLC Northern Breeze is a registered trademark of Ventline, Divn. of Philips Products, Inc.

FAN-TASTIC VENT

**MODEL 8000
CREATE-A-BREEZE**

Three fan blade speeds (low, medium, high), and a manual dome lifting knob.

Model 8000

C-A-B by Fan-Tastic Vent is an entry level best-in-class fan that is great for bathrooms or any 14" x 14" opening in your RV. 1 year limited warranty (all parts).



Technical Information:

- Durable, proven longevity.
- Quiet, 12-volt ceiling vent with 3 speeds.
- ASA Dome / 1 year warranty.
- Removable screen for easy cleaning.
- Low AMP draw insures full-time use.

- Specifications:**
- Rooftop weight: 8 lbs.
 - Outside dimensions: 16.5" x 16.5" x 4.5".
 - Performance SCFM/Amps/Decibels:
High - 920/3.00/40; Medium 653/2.29/39;
Low - 478/1.86/39.

66607 12V Create-A-Breeze Ceiling Fan #8000 **4**

FAN-TASTIC VENT

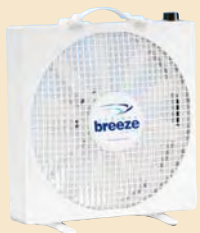

New design!

12volt only
12-VOLT "ENDLESS BREEZE" FAN



A new practical application for your favorite pet!

Endless Breeze is a high volume 12-volt fan with a 12" blade and operates at three speeds. Air movement of up to 1000-CMF (cubic feet per minute) is a major breakthrough in 12-volt portable fans. Standing only 14" H on retractable legs, and less than 3" thick, it travels and stores easily. Weights under 5 lbs. Endless Breeze can be powered by any 12-volt power source such as automobile lighter outlets or by connecting jumpers to any 12-volt battery. Maximum draw is less than 3 amps/hour. Comes with a 6' cord. Operates efficiently up to 14' from its power source.

12931 12-V Box Fan #1100WH **1**



66374

FAN-TASTIC VENT



62316

FAN-TASTIC VENT WITH 12V FAN

Fan-Tastic Vent is an investment in comfort. It provides immediate air exchanges with minimum 12-volt power usage. It's one of the most used appliances in any rig. Fresh, clean, outside air can be yours without generators, air conditioners or engines operating. All models fit standard 14" x 14" opening; and are 16.5" x 16.5" x 4.5". All have removable screen for easy cleaning. Choose fan blade direction (OUT for exhaust or IN for air intake). CSA certified; UL listed.

**Model 6600R with Hand Remote:
Fresh air in the palm of your hand™!**

No need to run wires down the wall...or bring a chair to reach the high ceiling! This air exchange system for the RV includes a hand held radio frequency remote that makes operation as simple as sitting in your easy chair and pushing a button. A convenient wall cradle lets you choose an easily accessible location, install the lightweight cradle, and operate the fan from the cradle, or remove the remote and operate from anywhere inside or outside your coach. 14 speed fan including reverse, Rain Sensor, automatic variable speed (Thermostat actuated) mode.

Model 6000RBTA

Just select your speed from this 3-speed model. Features Automatic Dome Opener with built-in Rain Sensor. Flip a switch and the dome opens or closes. Or when the sensor gets wet, the dome automatically closes; opens again when sensor is dry. Built-in thermostat helps keep the interior cool.

Model 5000RBT

A manual opening, 3-speed vent with reverse and thermostat. Hand crank open the dome, pick IN or OUT and your fan blade speed, set the

inside view of 62316



thermostat and the blades will start and stop according to the chosen temperature. Perfect for when you leave pets behind or while sleeping.

Model 4000R

A manual opening, 3-speed vent with reverse. Hand crank open the dome, choose IN or OUT and your fan speed. Fan blade is activated when dome is opened approximately 2".

Rain Sensor models have fully automatic opening and closing dome. When the rain stops, the dome re-opens.

Fan-Tastic Vent:

66374 Model 6600R 14-Speed 12V Fan with Reverse, Cradle, Thermostat, Automatic Opening Dome, Rain Sensor, Remote & Cradle #6600R-417 4WH **4**

62316 Model 6000RBT 3-Speed 12V Fan with Reverse, Thermostat, Automatic Opening Dome, & Rain Sensor #6000RBT-BRIGHT WHITE **4**

62467 Model 5000 RBT 3-Speed 12V Fan with Reverse & Thermostat, Manual Opening #5000RBT-BRIGHT WHITE **4**

62466 Model 4000R 3-Speed 12V Fan with Reverse, Manual Opening #4000R-BRIGHT WHITE **4**

FAN-TASTIC POP'N LOCK SCREEN

We are happy to introduce the new Pop 'N Lock Screens, allowing pop-in screen installation and replacement. The clip-on feature eliminates having multiple screws to install, making maintenance and cleaning a snap. The Pop 'N Lock screens are made of high-impact polystyrene and will replace all existing screens, covering up old screw holes and giving an attractive, sealed fit.

Pop'n Lock Screen, Bx/2:

67321 Off-White #K2035-80 **2**

67322 White #K2035-81 **15**

FAN-TASTIC VENT



Pop'N Lock fits any Fan-Tastic Vents!

67322



SHURflo Comfort Air Circulation Systems

COMFORT AIR VENTILATION SYSTEM

SHURflo's Comfort Air circulation fan lets you bring refreshing outside air into your coach while forcing out the old and stale.

- Sweeps in cool and fresh air.
- Evacuates old and stale air.
- Keeps pets cool while A/C is off.
- Removes odors quickly.
- Remote control operation (select models).
- Low amp draw ensures constant use.
- Designed to circulate air; not blow air.
- Dome closed operation.
- Whisper quiet operation.
- Fits standard 14" x 14" openings.

SPECIFICATIONS:

- **Voltage:** 12VDC.
- **Max Amps:** 4 Amps.
- **Operating Amps:** .30- 3.60 Amps.
- **Min Air Flow Intake:** 230 CFM.
- **Max Air Flow Intake:** 910 CFM.
- **Min Air Flow Exhaust:** 260 CFM.
- **Max Air Flow Exhaust:** 980 CFM.
- **Min DB Level:** 36 DB.
- **Max DB Level:** 39 DB.
- **Approvals:** CSA, FCC.

	SILVER SERIES	GOLD SERIES	PLATINUM SERIES
	 Part No. 275-C0104	 Part No. 275-C1004	 Part No. 275-R1234
Ceiling Control	<input type="checkbox"/>	<input type="checkbox"/>	<input type="checkbox"/>
Remote Control	<input type="checkbox"/>	<input type="checkbox"/>	<input type="checkbox"/>
Variable Speed	<input type="checkbox"/>	<input type="checkbox"/>	<input type="checkbox"/>
Exhaust	<input type="checkbox"/>	<input type="checkbox"/>	<input type="checkbox"/>
Intake	<input type="checkbox"/>	<input type="checkbox"/>	<input type="checkbox"/>
Power Dome	<input type="checkbox"/>	<input type="checkbox"/>	<input type="checkbox"/>
Thermostat	<input type="checkbox"/>	<input type="checkbox"/>	<input type="checkbox"/>
Rain Sensor	<input type="checkbox"/>	<input type="checkbox"/>	<input type="checkbox"/>

* Listed part numbers include flange to fit roof thickness 3.5" - 5.25". Other sizes available upon request.

Comfort Air™ Silver

Comfort Air™ Gold

Comfort Air™ Platinum Includes Remote Control



The Comfort Air Silver circulation fan is ideal for the bathroom and small living quarters such as the kitchen or the bedroom. The variable speed control allows for comfort at several different settings, guaranteeing your satisfaction at any level of air-flow. This exhaust-only fan pulls the stale air and unwanted odors from your coach, which then forces new air in from an open window. If you want a gentle breeze to cool you from overhead, simply close the dome and the air driven from the exhaust mode will bounce off the dome and back into the coach, creating the effect of a ceiling fan. Whether it's hot outside and you are looking to cool down, or your heater is blowing and you want to scatter the warm air, the Comfort Air Silver is the perfect first step for your air circulation needs.

- Exhaust only. • Variable speed. • White dome.
- Easy removable screen. • Operational with dome closed. • Whisper quiet operation.

66094 Comfort Air Silver Series
#275-C0104 1

The Comfort Air Gold circulation fan is equipped with a variable speed control that allows for comfort at several different settings, guaranteeing your satisfaction at any level of air flow. The exhaust feature pulls the stale air and unwanted odors from your coach, which then forces new air in from an open window. If you want a gentle breeze to cool you from overhead, simply close the dome and the air driven from the exhaust mode will bounce off the dome and back into the coach, creating the effect of a ceiling fan. For a more dramatic flow of air into your coach, switch the fan to intake mode where the variable speed gives you the power to set the fan at any speed up to 950 CFM, the most on the market.

- Bi-directional airflow. • Variable speed.
- Smoke tint dome. • Easily removable screen.
- Dome closed operation. • Whisper quiet operation.

66093 Comfort Air Gold Series
#275-C1004 1

The Comfort Air Platinum circulation fan features full remote operation that allows you to control comfort levels from your fingertips. Included is a handy wall mounting bracket that gives you the option of leaving your controls on the wall, or taking it with you to the bed or living area seating. Equipped with Bi-directional operation, thermostat setting, and a rain sensor, this all-in-one fan is ideal for circulating air throughout your whole coach. High ceilings are no longer a concern with this remote version, because there are no wires to run through the walls and installation is a breeze.

- Remote control operation. • Variable speed.
- Bi-directional operation. • Smoke tint dome.
- Easily removable screen. • Thermostat controlled. • Rain sensor closes dome automatically.
- Dome closed operation. • Whisper quiet operation.

66092 Comfort Air Platinum Series
#275-R1234 1

In Section H:	Roof Ventilation	Refrigerator Vents	Plumbing Vents	Registers & Grilles	Side Vents	Trim/Molding	Gutter Extensions
---------------	------------------	--------------------	----------------	---------------------	------------	--------------	-------------------

VENTLINE VENTADOME 14" x 14" VENT WITH RADIUS CORNERS



After 40+ years of the same look, Ventline has revolutionized the 14" x 14" roof vent!

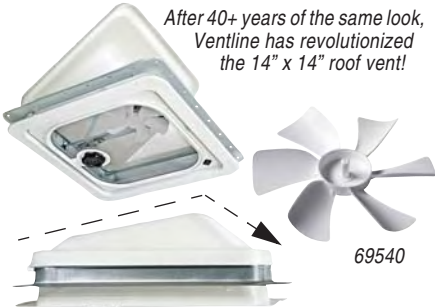

Powered, 14" x 14" Ventadome has a 150cfm fan for extra circulation.



65560



66591

Operating Knob

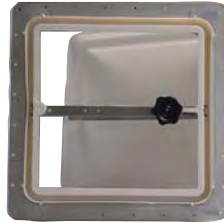

VENTADOME 14" x 14" VENT WITH RADIUS CORNERS

Non-powered Ventadome roof vents with tough plastic translucent covers provide maximum light and air capabilities. Steel constructed; easy-open operation, heavy-duty screens and superior weather seals. Rough-in opening is 14-1/4" square. Sun-resistant domes are high-impact polypropylene plastic. Molded-in color, plus a special UV ray inhibitor keeps color vibrant year after year.

61113 White, 110-V, without Garnish (Not shown) #V2128-511-00 5

65566 2-1/8" Plastic Garnish for Radius Corner Roof Vents, White #VA0445-26 24

KNOB OPERATOR

Ventadomes now feature a knob operator, replacing the traditional L-shaped crank handle. The round knob (66591) provides an easier grip and allows for a smoother operation of the lift assembly. The knob also detaches easily, permitting faster screen removal and cleaning. The knob is interchangeable with the L-shaped crank, so you can also use it on older vents.

METAL COVER VENTADOME

Non-Powered 14" x 14" Ventadome with Metal Cover, Radius Corner Screen Frame and Ceiling Garnish:

65560 Metal Cover Vent, Radius Corner #V2110SP-23 1

60759 Replacement Metal Dome #BV0534-00 20

65565 1-1/8" Plastic Garnish for Radius Corner Roof Ventadomes, White #VA0445-25 1

Garnish only

62320 3/8" Plastic Garnish for radius corner roof ventadomes, Birch White #VA0445-27 34

Another product improvement by Ventline that makes cleaning a snap!



VENTLINE SCREEN* FOR STANDARD VENTADOMES

Simply detach the screen by pinching the tabs located around the perimeter. There is no need to remove the ceiling garnish or the handle! The new frame with removable screen replaces the old style single piece screen.

REPL.. FRAME WITH REMOVABLE SCREEN

Birch White Frame w/remov. screen (2 pcs):

68788 For Standard 12V Powered Roof Ventadomes, Comes with rocker switch and wires, For models V2094, V2193 and V2394 #BVC0573-31R 1

68787 For Standard Non-Power Ventadomes #BVC0573-31 1

REMOVABLE SCREEN

Removable Screen Portion only:

68801 Birch White #BVD0434-31 1

68785 Polar White #BVD0434-41 1

* Please note that the pocket of the new screen is slightly different than the old screen. Customers may require a different length ceiling garnish.

GARNISH MODEL#	INSTALLED WITH...	NEW 2 PIECE SCREEN (VC0573TAB) VS OLD SINGLE PIECE SCREEN (VA0444TAB)
VA0445-27	V2092	3" to 3-15/16"
		2-7/8" to 4"
VA0445-26	V2094	2" to 2-15/16"
		1-7/8" to 3"
VA0445-25	V2110	1" to 1-15/16"
		7/8" to 2"
		New Style
		Old Style



SEE PAGE 175 FOR REPLACEMENT LIDS FOR VENTLINE VENTS SHOWN ON THIS PAGE

Phase I: Ventline's new aerodynamically shaped dome has 4X the impact strength of other polypropylene covers on the market. The improved lift mechanism provides a smooth operation and eliminates chatter. The slide mechanism has more surface area contact, making the guide bar stronger and allowing better distribution of stress.

Phase II: Snap-out screen easily detaches for cleaning. The ceiling garnish and crank handle remain in place no screws to lose.

Non-Powered New Style Ventadome:

67545 Birchwhite #V2092SP-25 1

67552 Bright White #V2092SP-28 1

67551 Smoke #V2092SP-27 1

Powered New Style Ventadome:

67553 White, 12V #V2094SP-28 1

69540 Fan Blade for standard unit #BVD0215-00 1

WEDGE SHAPE R REPLACEMENT DOME FOR VENTLINE NEW STYLE VENT

67542 White #BVD0449-A01 12

VENTLINE STANDARD HEIGHT REPLACEMENT LID FOR VENTLINE VENTS



Ventline Standard Height Cover

64961 White #BV0554-01 10

64962 Smoke #BV0554-03 10

VENTADOME REPLACEMENT PARTS

69749 NEW! 12V Repl. Motor Kit; Included in the kit is the VD0218 motor, motor lead wires, screws, instruction sheet and a drill template to retro-fit the VD0218 motor to the brackets used with the older motors (screw hole spacing is different) #BVD0218-00 1

65015 Repl. Operator w/crank handle and screw #BV0115-04 W/SCREW 20

66591 Ventadome Knob Only #BVD0421-15 15

65017 Repl. Operator with extension, crank handle and screw #BV0115-02 20

64926 12-V Motor, fits round shaft #BVC0468-01 1

64924 NEW! Fan Blade f/12-V roof Ventadome. 6-Blade CCW; fits .125 dia. round shaft with knurl; 6" dia.; White #BVC0466-00 1

46596 Vent Crank only (with bolt) #H710 1

64365 Vinyl Seal, 51" #BVA0101-00 1

66030 Pressure Switch #BV0199-04 1

ROOF VENTILATION

VENTS & TRIM



In Section H:	Roof Ventilation	Refrigerator Vents	Plumbing Vents	Registers & Grilles	Side Vents	Trim/Molding	Gutter Extensions
---------------	------------------	--------------------	----------------	---------------------	------------	--------------	-------------------

HONG'S



60750,
60751, 60752

HENG'S INDUSTRIES STANDARD MOUNT PAINTED METAL BASE VENTS

Features: • Self-Centering Device eliminates installation guesswork and assures perfect alignment in roof opening. • Attractive radius corners are standard. • Screen allows air through while keeping insects out. • Positive-seal weather-stripping is leak-resistant and water tight. • One-piece seamless frame with a deep drawn painted metal base. • Hinge: Heng's and 1995+ Jensen style without hinge pin.

Advantages: • Acrylic UV-Resistant translucent lid conforms to Federal Motor Vehicle Safety Standard (FMVSS; No.205 glazing materials). • Injection molded telescoping garnish accommodates a variety of roof thicknesses. • Hand crank to open and close lid securely.

COLONIAL WHITE METAL BASE

Non-powered (Screen Frame Is Pure White)

60750 Bronze #V773401-C1G1 10

60751 Smoke #V774401-C1G1 10

60752 White #V771401-C1G1 10

With 12V Fan Only:

60749 Vent with Smoke Lid, 12V Fan, Colonial White Metal Base #V774402-C1G1 10

Replacement Late-Model Lid, no pins required, for Heng's vents shown above:

62007 Amber Lid #J7291BZ-CR 10

62008 Smoke Lid #J7291SM-CR 10

62009 White Lid #J7291WH-CR 10

Additional Replacement Parts for above vents:

61974 Deep Garnish for 14" x 14" Vents, (fits ceilings 2 1/2" - 4 1/8" thick, measures 3 3/8" from top to bottom), White #JRP1120B 10

61975 ^{LS} Deep Garnish for 14" x 14" Vents, (fits ceilings 2 1/2" - 4 1/8" thick), Off-White #JRP1121B 10



**SEE PAGE 174 FOR ADDITIONAL
REPLACEMENT LIDS FOR
HENG'S VENTS SHOWN ABOVE**

HONG'S

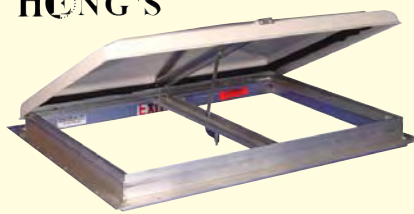

HENG'S INDUSTRIES ESCAPE HATCH / EXIT VENTS

Features: • Fresh air ventilation: A turn of the crank provides a large vent area. Lets air through, keeps insects out. • Includes opaque white plastic lid. • Sturdy frame installs easily and is made of heavy aluminum extrusion to assure secure mounting. • Dependable operation featuring leak-resistant lid and weather-tight frame. • White garnish included.

Advantages: • Instant exit. Screen opens quickly to assure fast exit through opening. • Largest selection: 13" x 20" to 26" x 26". • A strong fine mesh screen.

ESCAPE HATCH / EXIT VENT W/WHITE LID

60255 15" x 20" Escape Hatch, with 4 pc., 2" White Metal Garnish; Cutout: 17-1/2" x 24-1/2" #58621-C2 5

61631 17" x 24" Escape Hatch, with 4 pc., 2" White Metal Garnish (RVIA); Cutout: 19-1/4" x 26-1/4" #48621-C2 5

60372 26" x 26" Escape Hatch, with 4 pc., 2" White Metal Garnish (RVIA); Cutout 25-7/8" x 25-7/8" #68631-C2 5

REPLACEMENT DOME

60272 For Old-Style 13" x 20" Vent, 15" x 22" Lid Size #90007-C1 1

60256 For 15" x 22" Vent, 18-1/2" x 25" Lid Size #90008-C1 1

61624 For 17" x 24" Vent, 19-3/4" x 26-1/2" Lid Size #90088-C1 1

The 60371 style dome has a 1-5/8" H hinge plate, and one track down the middle. Fits vents made 1995 to date. 26" x 26". Opaque.

60371 For 26" x 26" Vent, 26-1/2" x 26-1/2" Lid Size #90014-C1 1

OLD STYLE REPLACEMENT DOME

The old style dome has a 2-1/4" H hinge plate, and one track down the middle. Opaque white. 26" x 26".

60882 Old Style Replacement Lid #900140S-1 1

REPLACEMENT PARTS FOR DISCONTINUED JENSEN ASTRO-ROOF VENT

Parts for the Astro-Roof vent with instant escape release hatch. *Vent no longer available.*

Replacement Parts Only

60174 22" x 22" Dome #J294X22WH 1

60099 ^{LS} 26" x 26" Dome #J294X26WH 1

HONG'S

*Garnish
sold separately*

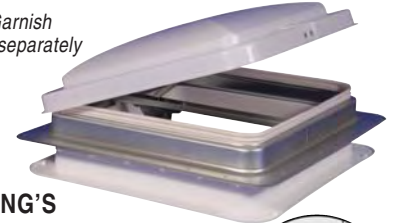

HENG'S INDUSTRIES STANDARD MOUNT UNIVERSAL VENTS

Features: • Self centering metal base w/radius corners. • Interior garnish w/wider 1-1/4" flange and radius corner. • Available in standard, 12-volt, CSA and UL approved 110-volt. • Designed to withstand excessive wind and weather. • Hinge: Crimp sheet metal.

Advantages: • Universal, fits all rough openings. • Flange covers all screws holes. • One piece metal frame, deep drawn metal base. • Covers all interior stains left by previous garnishes. • Positive-Seal weather stripping is leak resistant and water tight. • Interchangeable with existing Elixir and Ventline products.

*Galvanized Base, Non-powered
(Screen Frame is Pure White):*

69633 Amber #73111-C1G1 10

69635 Flat Galvanized #75111-C1G1 10

69634 Smoke #74111-C1G1 10

69632 White #71111-C1G1 10

Replacement lids for above plus Elixir vents 1995 and newer (universal) & Ventline vents:

61345 Metal f/69635 #90114-CR 10

61334 White f/69632 #90110-CR 10

**See pages 174-175 for additional
replacement lids for above vents.**

REPLACEMENT PARTS FOR ABOVE VENTS

White Garnish, 1-1/4" Wide Mounting Flange:

69636 1-1/8" Vertical Leg #90090B 10

69638 3" Vertical Leg #90092B 10

69639 4" Vertical Leg #90094B 10

60266 ^{LS} Lid, Metal, Elixir old style series 20000 #90005-C1 1

64926 12-V Motor, with Round Shaft #BVC0468-01 1

65390 Screen Frame, White. Garnish telescopes inside screen frame #90106-C1 5

60432 Clockwise Fan Blade for 12-Volt Vent #90038-C1 5

65012 Operator for 14" Elixir & Jensen Vents, w/o Crank Handle, 6" Arm Length, 1/Bag #JRP1000R-C 5

41361 Replacement Operator, 6" Arm Length w/Crank Handle, (same as #65012) CD/1 #814CK 10

60178 Crank Handle for replacement operator, Metal, 3/Card #JRP2160R-C 5



HONG'S

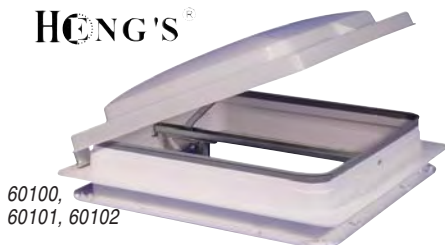

60100, 60101, 60102

STANDARD MOUNT PLASTIC BASE JENSEN-STYLE VENT by HENG'S INDUSTRIES

Features: • Exclusive Self-Centering Device eliminates installation guesswork, assures perfect alignment in roof opening. • Attractive radius corners are standard. • Screen allows air through, keeps bugs out. • Positive-seal weather stripping is leak-resistant and weather-tight. • Hinge: Jensen-style slotted.
Advantages: • Acrylic UV-Resistant translucent lid conforms to Federal Motor Vehicle Safety Standard (FMVSS). • Hand crank opens and closes lid securely. • 14" x 14" vents with 1-1/2" (vertical leg) white garnish and white screen. • Individually boxed.

WHITE BASE, NON-POWERED

- 60101 Amber #V073101-C1G1 10
- 60102 Smoke #V074101-C1G1 10
- 60100 White #V071101-C1G1 10

WHITE BASE, WITH 12-V FAN

- 60012 12V, White #V071102-C1G1 10



62430 or 61450



Remote switch included in #61450 Power Lift Roof Vent

WHITE BASE, WITH 12-V FAN & LIGHT

Vent with integral 12-volt light has a translucent plastic lens and four 3-watt low-voltage lights.

- 62430 Lighted Vent, White with 12-V Fan #V071112-C1G1 10

- 69631 Replacement Lens for Jensen V071112 or V071142 #JRP1161R-C 5

WHITE BASE, 12V FAN, LIGHT & POWER LIFT

Vent with power lid-lift uses 12-volt DC motor operated by a convenient remote switch.

- 61450 Vent with White Plastic Lid, 12-V Fan and 12-V Lights for 1"-2-9/16" Roof Thickness #V071142-C1G1 10

HONG'S



69641

Saves installation time!



HENG'S INDUSTRIES CLAMP STYLE PAINTED METAL BASE VENTS

Features: • Self-Centering Device eliminates installation guesswork and assures perfect alignment in roof opening. • Exclusive four-screw inside flange mount feature for attaching base garnish to lid mount. Saves labor on installation. • Screen allows air through while keeping insects out. • Attractive radius corners are standard. • Positive-seal weather-stripping is leak-resistant and water tight. • One-piece seamless frame with a deep drawn painted metal base. • Unique integral hinge system on lid. **Advantages:** • Acrylic UV-Resistant translucent lid conforms to Federal Motor Vehicle Safety Standard (FMVSS; No.205 glazing materials). • Injection molded telescoping garnish accommodates a variety of roof thicknesses. • Hand crank to open and close lid securely. • Hinge: Heng's & 1995+ Jensen style without hinge pin.

PURE WHITE BASE SCREEN FRAME

- 69640 Non-Powered, White #V971201-C1G1 10
- 69641 Vent with 12V Fan, White #V971202-C1G1 10

VENTLINE



REPLACEMENT PARTS FOR VENTLINE EXIT DOMES

Parts for the model #V2047 (22" x 22", pictured above) and for the discontinued model #V2052 (15 1/2" x 22 1/2").

- 60763 Replacement Dome (Lid) for V2047-01 Exit Vent, white; nominal overall flange size 24" x 24"; rough opening of 22" x 22"; #BV0586-04 1
- 60765 ^{LS} Replacement Dome (Lid) for V2052 Exit Vent, White; nominal overall flange size 17" x 24"; rough opening of 14-1/2" x 21-1/2" #BV0586-03 6
- 65020 Replacement Operator with Guide Roller, Crank Handle and Screw #BVA0179-00 W/SCREW 1



SEE PAGE 174 FOR REPLACEMENT LIDS FOR HENG'S VENTS SHOWN ABOVE

HONG'S



9" X 9" "MINI ROOF VENT"

This convenient 9" x9" lightweight vent is ideal for providing fresh air in small places such as bathrooms, passageways, galleys, etc. This mini vent is weatherproof due to the quality high-impact plastic used in its construction.

- 60267 Colonial white opaque 9" roof vent with 7/8" plastic garnish, Boxed #17511-C1G 10



SEE PAGE 174 FOR REPLACEMENT LIDS FOR HENG'S VENTS SHOWN ABOVE

In Section H:

Roof Ventilation

Refrigerator Vents

Plumbing Vents

Registers & Grilles

Side Vents

Trim/Molding

Gutter Extensions

HONG'S®



NEW!



From this...



... to this!

HENG'S INDUSTRIES VORTEX FAN REPLACEMENT KIT

Don't just move air, create a VORTEX!

Update your old, inefficient powered vent easily without replacing the entire vent or compromising the rooftop seal. Just replace your existing screen with the Vortex upgrade kit. Make your outdated vent more powerful without buying a whole new and expensive vent.

Replacement is easy and only a Phillips screwdriver is needed. Tampering with the rooftop seal is NOT necessary. The Vortex vent works with Ventline, Jensen and Elixir powered U.S. vents. Nonpowered vents can be converted with some additional wiring.

69150 Vortex Fan Replacement Kit
#90043-CR 8



THE VENT STICK

High RV Ceiling Vents Are Now Within Reach!

No more foot stools or ladders. The VentStick makes it easy to open and close any RV vent in seconds and lets you do it with both feet firmly on the ground. The special knob installs in minutes.

66081 VentStik with One Knob
#29070 1

66080 Knob 2-Pack with Rings
#29103 1



VENTMATE FAN BLADES

REPLACEMENT 6 FAN BLADES

"6" fan blades for 12-v powered roof vents and range hoods. White, impact-resistant plastic. Direction of spin is determined by looking down through the motor, at the top of the blade.

12-V Powered Vent Fan Blade:

65483 Ventline, 1/8" Round Bore, CCW, CD/1 #65483 1

65484 Jensen, 1/8" D Bore, CW, CD/1 #65484 1

65485 Ventline & Pre '95 Jensen, 1/8" D Bore, CCW, CD/1 #65485 1

65491 Current Ventline, 3/32" Round Bore, CCW, CD/1 #65491 1

12-V Powered Range Hood Fan Blade:

65484 '95-Present Jensen, 1/8" D Bore, CW, CD/1 #65484 1

65485 Pre '95 Jensen, 1/8" D Bore, CCW, CD/1 #65485 1



JENSEN VENT REPLACEMENT PARTS by HENG'S INDUSTRIES

Motor for 12-volt power vents, fits Elixir, Heng's, Jensen & Ventline.

67249 12-V Motor, with D Shaft
#90037-C1 5

65012 Operator for 14" Elixir & Jensen Vents, w/o Crank Handle, 6" Arm #JRP1000R-C 5

60178 Vent Crank Handle; Metal, CD/3
#JRP2160R-C 5

R Designer

RV DESIGNER VENT CRANK

Fits Jensen, Elixir & Ventline vents. 2" crank with 3/4" shaft. Metal. Bolt included, Pk/1.

46596 Vent Crank #H710 1

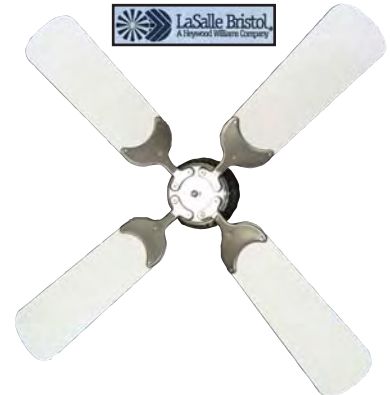

LASALLE BRISTOL 12V CEILING FAN

Experience the comfort, style and convenience of a ceiling fan in your recreational vehicle. This 4 blade, 42" designer hugger, 12 volt ceiling fan features four speeds plus reverse, a mounted wall switch, and a low profile (6" off ceiling). Contemporary white design matches most decors. Individually boxed. Easy to install. Low 1.18 amp draw.

67252 Ceiling Fan with Wall Switch
#DC1242WH 1



RV DESIGNER VENT/ACCESSORY MOUNTING KIT

Use to seal and attach vent or any accessory mounted to the outside of an RV. Includes 8' of white, 3/4" putty tape & 24 #8 screws.

65373 Vent Mounting Kit #E451 12



JR PRODUCTS

JR PRODUCTS VENT INSTALLATION KIT

Vent installation kits have everything you need to replace your existing vent or install a new one. Comes complete with 36 screws and 8' of putty tape. Packaged in convenient, resealable clamshell.

65051 Vent Installation Kit
#04162 12

67502 Butyl Vent Installation Kit
#04182 18

In Section H:	Roof Ventilation	Refrigerator Vents	Plumbing Vents	Registers & Grilles	Side Vents	Trim/Molding	Gutter Extensions
---------------	------------------	--------------------	----------------	---------------------	------------	--------------	-------------------

ROOF VENT OPERATOR



Roof Vent Operator, CD/1:

- 44100** 4" Arm #794CK 10
- 44108** 5" Arm #898CK 10
- 41067** 7" Arm #807CK 10

VENT OPERATOR KIT

1/card, with screws.



Vent Operator Kit :

- 41066** 5" Arm Length #806CK 10
- 41361** 6" Arm Length #814CK 10



With a pull strap for easy removal!



VENTMATE VENT CUSHION WITH PULL STRAP



- Simply push the 3" thick R-4 insulated insert into any standard 14" roof vent and save energy.
- Prevents heat loss during cold nights.
- Increases A/C efficiency during hot days.
- Pull strap for easy removal. • Inserts easily into vent. • Great for summer or winter.
- Keeps light out.

67304 Vent Cushion with Pull Strap #67304 8



ADCO VENT COVER



Vent Cover insulates and blocks sunlight, moonlight or street lights from your RV's interior.



Installs and removes easily in seconds using supplied Velcro. Rugged, durable vinyl with reflective silver finish on one side provides better insulation and blocks heat. 18" x 18" overall size to cover virtually any 14" x 14" roof vent. White/Silver color. 3-yr. mfr. warranty.

86045 Vent Cover #7172 1



CAMCO RV DUAL VENT COVER



Block sun and prevent interior fading, while enjoying great air circulation. Easy to install: holding clips fit existing screw holes.

60096 Vent Cover, White #45651 6



HENG'S INDUSTRIES THERMAL PANE ROOF VENT CAP



This vent cap was designed to extend the camping season for the part time camper and a must for full timers. The cap is one piece, has no seams or welds, with an air space between two layers. This design gives you a thermal break increasing the r-value and decreasing condensation. The cap stops condensation from forming on the inside, and running down the fascia into the attic, and rotting the roof! This could save staining on the Luan board, or possibly save the cost of replacing a whole roof! Stops molding and therefore helps with health issues. It also keeps the heat in/out and the A/C in/out. The benefit to the customer is savings on the heat bill, and having the recreational vehicle looking new longer.

68648 Thermal Pane Roof Vent Cap #90110-C1DL 24

CAMCO REFLECTIVE VENT QUICK COVER



Insulated vent cover reduces heat loss in winter and reflects sunlight and heat in summer. Easy installation and removal with hook & loop fasteners (included). Attaches to vent frame or ceiling for a quick peel-and-stick installation.



67467 Quick Cover, 14" x 14" #45191 12



VENTLINE CEILING EXHAUST FAN



Powered ceiling or bath fan, very efficient for smaller areas. Consists of the following parts: • Cap and roof flange assembly (sold separately). • Power unit (motor, fan, and pipe assembly). Inside grille is 10" dia. Self-closing foam damper opens and closes. Dynamically balanced polypropylene blade will not bend out of shape. 8" dia. rough-in opening required

61128 7" Fan w/o Cap & Flange, 115V, 100CFM #V2262-50 1

61121 Fan Blade only for 7" insert fans and sidewall fans; 3 blade CW; fits .214 dia. round shaft with knurl; 6 1/2" dia; white #BVA0312-00 1



VENTLINE VANAIR ROOF BLOWER



An efficient blower that comes with a 12 VDC motor, drawing 1.5 amps. High-impact plastic dome and body needs only a 6-1/4" opening. Trim ring telescopes to adjust to roof thickness from 1-1/2" to 2-1/2". Leak-proof. Interior color is polar white; comes complete with cane-mesh screen. Easy 1-hand opening/closing for ease of operation. Blue/grey smoke covered exterior color.

65734 Roof Blower #VP-543 12

62321 Replacement cover only #BVA0502-03 1



JCJ ENTERPRISES MUD DAUBER SCREEN FOR REFRIGERATOR VENTS

Protective screen keeps out mud daubers, wasps, mice, birds and more, without blocking air flow. Heavy stainless steel—just install and forget. Package contains 3 screens plus plastic ties to easily attach to vent door cross bar.

Mud Dauber Screen for Refrigerator Vents:

65685 For Norcold #R-300 24

66590 For Dometic #R-600 24

REFRIGERATOR VENTS

VENTS & TRIM

H

In Section H: Roof Ventilation Refrigerator Vents Plumbing Vents Registers & Grilles Side Vents Trim/Molding Gutter Extensions



VENTMATE REFRIGERATOR VENT LIDS

Made of high impact plastic. UV stabilized. **65528, 65529, 65597** and **65598** are direct replacement lids for Dometic refrigerator vents. **65532** is a direct replacement lid for Norcold refrigerator vents.

Refrigerator Vent Lid, Polar White, Fits:

- 65532** Norcold #65532 1
- 65528** Dometic N/S #65528 10
- 65529** Dometic O/S #65529 1

Refrigerator Vent Lid, Colonial White, Fits:

- 65597** Dometic N/S #65597 1
- 65598** Dometic O/S #65598 1



RV DESIGNER LATCHES

REFRIGERATOR/ CONVERTER VENT LATCH

Latch commonly used on exterior access door for fridge vent, inverter door, etc.

- 43977** Fridge/Converter Vent Latch #E377 12

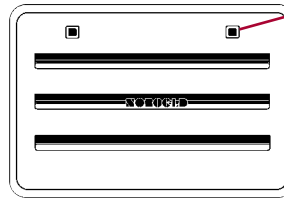

VENTS FOR NORCOLD REFRIGERATORS

ROOF VENT

Low profile plastic roof vent for use with all models. Complete set includes cap and base (*order separately*). Installation cutouts 5-1/4" H x 24".

- 65532** Vent Cap Only, Polar White #65532 1
- 65309** Base Only #616319BWH 12

SIDE VENTS

Plastic Side Vent. 13-3/4" H x 21-1/2" W cut-out size; 16-1/2" H x 24-1/4" W overall size:

- 61750** Polar White #621156PW 12
- 62765** Latch only #617772 1
- Upper Side Vent For Models 322, 422/3, 452/3, 652/3. 7-1/4" H x 20-7/8" W:
- 61880** Polar White #617485PW 1
- Lower Side Vent For Models 322, 422/3, 452/3, 652/3. 9-9/16" H x 19-1/8" W:
- 61889** Polar White #617484PW 1



VENTLINE METAL REFRIGERATOR ROOF VENTS

CUTOUT: 5" X 18"

White prefinished metal, streamlined design cover. With bug screen. *Order cap and base separately.*

- 61124** Vent Cap, overall size, 10 1/2" x 18 1/16" x 2 15/16", White #V0157-03 20
- 61131** Base with screen, overall size 7 1/2" x 20 13/32" #V0504-00 1

CUTOUT: 5" X 20"

- 65690** Vent Cap, overall size, 11 9/16" x 20 3/4" x 3", White #V0432-03 20
- 61958** Base with screen, overall size 7 1/2" x 22 13/32" #V0565-00 20

CUTOUT: 5" X 24"

- 65689** Vent Cap, overall size, 11 1/2" x 24 3/4" x 3", White #V0203-03 20
- 61132** Base with screen, overall size 7 1/2" x 26 13/32" #V0523-00 1

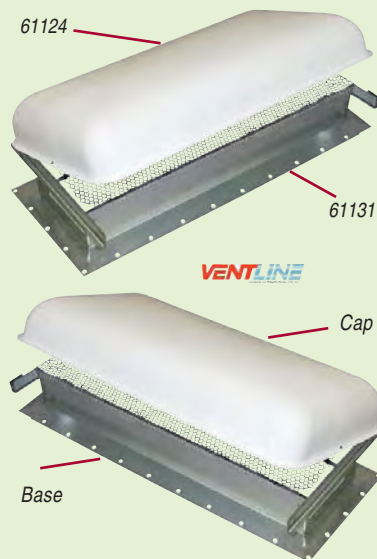

JR PRODUCTS HATCH INSTALLATION KIT

Installation kit with everything you need to replace or install a hatch. Includes premium butyl tape and screws for a proper seal.

Hatch Installation Kit:

- 65439** Small (25" butyl tape and 12 screws) #04205 36
- 65440** Large (36" butyl tape and 10 screws) #04195 36



In Section H:	Roof Ventilation	Refrigerator Vents	Plumbing Vents	Registers & Grilles	Side Vents	Trim/Molding	Gutter Extensions
---------------	------------------	--------------------	----------------	---------------------	------------	--------------	-------------------

**HONG'S®
HENG'S
PLUMBING VENT**



Made of tough exterior plastic with a weather resistant finish. They feature a unique cap which can be locked on or removed with a twist of the wrist without the need of tools. These vents are made to fit pipes up to 2" in diameter with a 2-1/2" projection above the roof.

Plumbing Vent:

- 61404 Colonial White #10002-C 25
- 69642 Polar White #10001-C 25



**JR PRODUCTS
HORSESHOE
VENT**



Made of durable long lasting plastic that won't fade or discolour. Perfect for replacing existing vents or to install a side vent.

- 67303 Horseshoe Vent, Polar White #298-01-A-PW-A 1

5" METAL PLUMBING VENT



Vent pipe is 5 1/16" i.d. for 5" nominal duct size. Stands 4 1/8" above flange. For flat roof.

- 61125 5" Metal Vent #V2005-00 1



65735

62334

VENTLINE PLUMBING VENTS

GALVANIZED STEEL: Made of galvanized steel for 1 1/2" pipe. Removable cap.

- 65735 Plumbing Vent w/Cap #V2084 1

PLASTIC: Plastic vent fits pipes 1 1/2".

Plumbing Vent:

- 60026 Colonial White #V2049-03 100
- 62334 White #V2049-01 100

**LASALLE BRISTOL
VENT CHEK**



Vent Chek makes fixture replacement easier, solves the problem of concealing an unsightly vent pipe. Eliminates the vent stack cover at the fixture vent and the possibility of roof leaks. Permits normal drainage and prevents "P" trap siphonage. 1-1/2" MPT. *NOTE: Vent Chek does not eliminate the main vent stack.*

- 21028 Vent Chek #74BPC67 1



CAMCO CYCLONE PLUMBING VENT

Use the power of the wind to draw holding tank odors out of your RV. Even a gentle breeze works with the dynamically engineered shape of the Cyclone™ to create a powerful vortex that pulls odors up and away. Attaches easily to any RV plumbing vent. Patent Pending.

- 69253 Sewer Vent Cover #40595 3



Only for "4 prong" plumbing vent

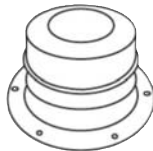

**JCJ ENTERPRISES MUD DAUBER
SCREEN FOR PLUMBING VENTS**

Keeps out wasps, mud daubers and other pests; keeps your vent clear.

- 65742 Pipe Vent Mud Dauber Screen #PV-400 6



67232

67231

**CAMCO REPLACE-ALL
PLUMBING VENT CAP ONLY**

Separate cap fits up to a 2" pipe. Features spring tension attachment, which eliminates the need to replace the entire vent just because of a lost cap top. Patented.

Replace-All Plumbing Vent Cap Only:

- 67232 Beige #40134 6
- 67231 Polar White #40034 6



NEW!



**ULTRA-FAB
PRODUCTS
MINI SOLAR
PLUMBING VENT**

- Automatically removes RV plumbing odors and moisture. • Silent and reliable ventilation. • Aerodynamic for less drag co-efficiency. • Durable powder coated finish. • Installs easily on roof top. • No wiring required. • Universal design replaces most RV plumbing caps. • Solar powered start and stop. • 3-yr. warranty.

- 69847 Mini Solar Plumbing Vent #53-945001 20

D & W INC. PRODUCTS

**SPACEPORT OUTLET
VENT FOR DUCTED
A/C SYSTEMS**



Designed as an upgrade replacement of the popular Aireport vents used in the ceilings of most RVs. The Spaceport both opens and closes, and rotates for the ultimate in comfort control. Easy to install; just remove screws of old vent and replace with the Spaceport. 6-7/16" overall dia.; 4-5/8" hole size.

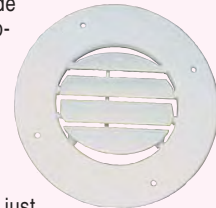

- 61452 Outlet Vent #8840WH 1

AIREPORT GRILLE

A louvered version of the Aireport Diffuser lets you direct the air exactly where you wish. Easily installed and efficient in operation. All Aireports are interchangeable after installation. 7" overall dia; 4-1/4" hole size. White.

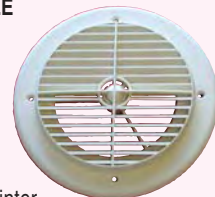

- 61451 Aireport Grille #6840WH 1

AIREPORT DIFFUSER

The adjustable Aireport Diffuser for ducted air conditioners offers 360° air maximum comfort and efficiency, plus a unique design feature that eliminates condensation. Partially closeable. 6.5" overall dia; 4-1/4" hole size. White.



- 61449 Diffuser #5840WH 1

Refer also to page 66 for the solar vent from Sunforce Products!

REGISTERS • FLEX DUCT • SIDE VENTS

VENTS & TRIM



In Section H:	Roof Ventilation	Refrigerator Vents	Plumbing Vents	Registers & Grilles	Side Vents	Trim/Molding	Gutter Extensions
---------------	------------------	--------------------	----------------	---------------------	------------	--------------	-------------------



BRD ROTAIRE REGISTER

Rotaire register is molded from durable ABS plastic in a variety of colors. The damper mechanism can be easily opened and closed and may be completely removed for full flow. Grill rotates a full 360° to direct air flow where desired. 4" dia. mounting collar; overall 5" dia. by 2-1/4" D.

Rotaire Register:

- 65591** Beige, 4" #16511 1
- 65593** Black, 4" #16611 1
- 65592** Walnut, 4" #16411 1
- 65596** White, 4" #16711 1
- 68666** White Provent, 5" (fits 4" opening) #16812 50



AP PRODUCTS FLOOR REGISTER

Sturdy metal construction with extra-deep flange. Easy, fast installation. Narrow spaced fins and wide flange are important home owner features. Adjustable. 1" Deep.
NOTE: size shown is the hole size.

4" Wide Register (5-1/4" Outside), Brown:

- 68646** 8" L #013-626 48
- 68641** 10" L #013-628 48
- 68644** 12" L #013-630 48

4" Wide Register (5-1/4" Outside), White:

- 68647** 8" L #013-625 48
- 68643** 10" L #013-627 24
- 68645** 12" L #013-629 24



BRD FLEXIBLE DUCT

4" x 25' flex hose; clamps not included.

- 65594** Flex Duct, 4" x 25' #16815 6

EXTERIOR VENT FOR VENTLINE DUCTED RANGE HOODS



Weatherproof Outside Vent features a lockable damper, heavy styrene construction and a 1-3/4" inlet flange. Rough opening is 3-3/4" x 10-1/2". Overall size 11-5/8" x 5-9/32".

Horizontal Outside Vent:

- 64357** Colonial White #V2111-11 24
- 61898** Polar White #V2111-13 24



RV DESIGNER FLOOR REGISTER WITH DAMPER



- OD 12" x 3-1/2", Cut-out 10" x 2-3/8" x 1".
- Clamshell of 15" W x 7" H x 2" D. • Plastic.

Floor Register with damper, Plastic:

- 69297** White #H850 g
- 69298** Tan #H860 g



JR PRODUCTS PLASTIC REGISTER

These registers meet and exceed H.U.D. and R.V.I.A. specifications. They are made of molded thermoplastic and will not rust. Corners are rounded so there are no sharp edges. Easy to install, easy to open and close. The color is solid throughout the register, so it cannot scratch or peel away. Overall size 12" x 4 1/4"; cutout size 10" x 2 3/8".

Undampered Register

- 62350** Polar Wht. #288-86-A-PW-A 12
- 78842** Tan #288-86-A-TN-A 2

Dampered Register

- 62353** Polar Wht. #288-86-AB-PW-A 12
- 78843** Tan #288-86-AB-TN-A 2



EXTERIOR VENT FOR VENTLINE DUCTED RANGE HOODS



Louvered design. 1-3/4" inlet size; cutout: 10-1/2" x 3-3/4"; overall: 12-1/8" x 5-1/4". Constructed of durable injection molded plastic.

Vent, Outside Louver:

- 61126** Colonial White #V2018-02 70
- 66630** Polar White #V2018-01 70

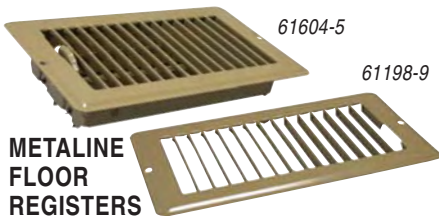

METALINE FLOOR REGISTERS AND RETURN AIR FLOOR GRILLES

Durable brown finish. Easy to open and close.

Double Shutter Register:

- 61605** 4" x 8" #12509 48
- 61604** 4" x 10" #12511 48

Return Air Grille without Dampers:

- 61199** 5 3/8" x 9 1/4" Return, For 4" x 8" Opening #10F2509 12
- 61198** 5 3/8" x 11 3/4" Return, For 4" x 10" Opening #10F2511R 48

HENG'S EXHAUST SYSTEM

This unit consists of an attractive exterior vent cover designed to keep rain and dust out of your vehicle with an outside manual release damper. Once the outside manual release damper is unsecured, the damper automatically opens when the range hood fan is activated to allow cooking odors and smoke to be exhausted. The damper automatically closes to prohibit insects and dust from entering when the range hood is not in operation. The manual release damper must be secured before traveling. Dim.: 4.62 x 10.88". Cutout: 4" x 10.86".

Durable Standard Vent Cover with Damper:

- 66289** Bright White #J116AWH-C 60
- 62810** Almond #J116AOW-C 60



VENTLINE SIDEWALL EXHAUST VENT

Graceful styling covers total efficiency and performance, all moving parts are weather protected. Fan starts when outside cover opens, stops when closed. Fits 2" -3" wall thickness. Outside door insulated. 110-V. Cut-out size: 9.5" x 9.5", U.L. Listed; CSA approved. Complete unit consists of vent/fan plus grille.

- 65683** Complete Sidewall Vent/Fan with Grille, White Cover #V2215-21 1

REPLACEMENT PARTS

- 61121** Fan Blade for 7" insert fans and sidewall fans; 3 blade CW; fits .214 dia. round shaft with knurl; 6 1/2" dia; white #BVA0312-00 1
- 61111** Pressure Switch #BV0140-03 1

In Section H:	Roof Ventilation	Refrigerator Vents	Plumbing Vents	Registers & Grilles	Side Vents	Trim/Molding	Gutter Extensions
---------------	------------------	--------------------	----------------	---------------------	------------	--------------	-------------------



Philips Style

SCREW COVERS

HEHR Style

Elixir Style

Give your louver-type doors and windows a smooth, finished look with these plastic screw covers. Dealer packs of 10 only.

Elixir Style, Pk/10 Screw Covers, 8' L:

- 48308 Black #011-355-10 1
- 45413 Colonial White #011-354-10 1
- 45416 Polar White #011-357-10 1

Hehr Style, Pk/10 Screw Covers, 8' L:

- 45412 Colonial White #011-362-10 1
- 45415 Polar White #011-365-10 1

Philips Style, Pk/10 Screw Covers, 8' L:

- 45411 Colonial White #011-358-10 1
- 45414 Polar White #011-361-10 1



RV DESIGNER INSERT TRIM

STANDARD INSERT TRIM

Flexible vinyl trim used in aluminum channels on outside of many RVs and campers. Cut with scissors. Easy to install. 25' roll.

3/4" wide, Standard:

- 46105 Colonial White #E331 1
- 48093 White #E330 1

1" wide, Standard:

- 46102 Beige #E325 1
- 46104 Black #E329 1
- 46103 Brown #E327 1
- 46101 Colonial White #E323 1
- 46100 White #E321 1

HEAVY DUTY INSERT TRIM

Heavy duty trim last longer; stays in the groove. Fits standard 1" channel. Longer "wings" grip track; thicker material holds shape.

1" wide, 25' Roll, Heavy Duty:

- 46967 Black #E369 1
- 46964 Colonial White #E363 1
- 46963 White #E361 1

1" wide, 100' Roll, Heavy Duty:

- 47563 Black #E469 12
- 47560 Colonial White #E463 12
- 47559 White #E461 12

DRIP CAP



Mill-finish aluminum drip caps divert rain and melting snow from doors and windows. Used to protect door and window openings of all types including mobile homes, RVs, horse trailers, portable toilet enclosures, etc. With formed ends and punched screw holes. Note: Measure lengths from inside the curve, as illustrated. The overall length equals Dimension "A" + 3.5".

- 61250 9" L Drip Cap #300900 5
- 61247 14" L Drip Cap #301400 5
- 61415 16" L Drip Cap #301600 5
- 61416 18" L Drip Cap #301800 5
- 60526 19" L Drip Cap #301900 5
- 60527 21" L Drip Cap #302100 5
- 60528 24" L Drip Cap #302400 25
- 60640 27" L Drip Cap #302700 25
- 60529 30" L Drip Cap #303000 25
- 60641 32" L Drip Cap #303200 25
- 60530 34" L Drip Cap #303400 25
- 61248 36" L Drip Cap #303600 25
- 60531 40" L Drip Cap #304000 25
- 61249 42" L Drip Cap #304200 5
- 60532 44" L Drip Cap #304400 5
- 60533 46" L Drip Cap #304600 5
- 61419 49 1/2" L Drip Cap #304912 25
- 60534 52 1/2" L Drip Cap #305212 5
- 60642 56" L Drip Cap #305600 5
- 61420 59 1/2" L Drip Cap #305912 5
- 61251 64 1/2" L Drip Cap #306412 25
- 60643 73 1/2" L Drip Cap #307312 5

VINYL INSERT



Rolls of insert for your trim to match the decor of your RV, or to change it! Flat interior is 3/4" wide; overall width is 1".

Vinyl Insert, 25 ft. Roll, Blister Pack:



- 46923 Black #10015 18
- 46922 Brown #10055 18
- 46924 Colonial White #10035 18
- 46925 Designer Beige #10045 18
- 48799 White #10025 18

Vinyl Insert, 50ft. Roll, Shrink Wrapped:



- 47825 Black #10061 1
- 47827 Colonial White #10081 1
- 47826 White #10071 1

Vinyl Insert, 1000 ft. Roll:



- 45501 Black #011-312 1
- 45503 Colonial White #011-313 1
- 45502 White #011-311 1

DRIP RAIL

Standard drip rail. (Sold only in tube of 10 pieces, 16 ft. long.)

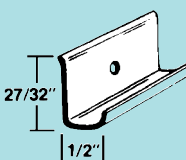

- 40202 Tube/10 Drip Rail, Arctic White #CDS-40202 1

FLAT INSERT TRIM

Flat insert trim. (Sold only in tube of 10 pieces, 20 ft. long.) Uses vinyl insert.

Flat Insert Trim.

(Sold only in tube of 10 pieces, 20 ft. long):

- 49944 Arctic White #CDS-49944 1
 - 41137 Colonial White #CDS-41137 1
 - 41121 Mill Finish #CDS-41121 1
- End Caps, Bag/10:
- 49946 Arctic White #CDS-49946 1
 - 41135 Colonial White #CDS-41135 1
 - 41134 Mill Finish #CDS-41134 1

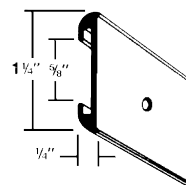
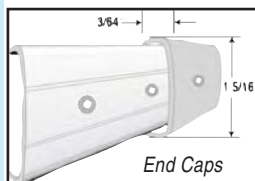

MOLDING • DRIP RAIL • GUTTER EXTENSIONS

VENTS & TRIM



In Section H:	Roof Ventilation	Refrigerator Vents	Plumbing Vents	Registers & Grilles	Side Vents	Trim/Molding	Gutter Extensions
---------------	------------------	--------------------	----------------	---------------------	------------	--------------	-------------------

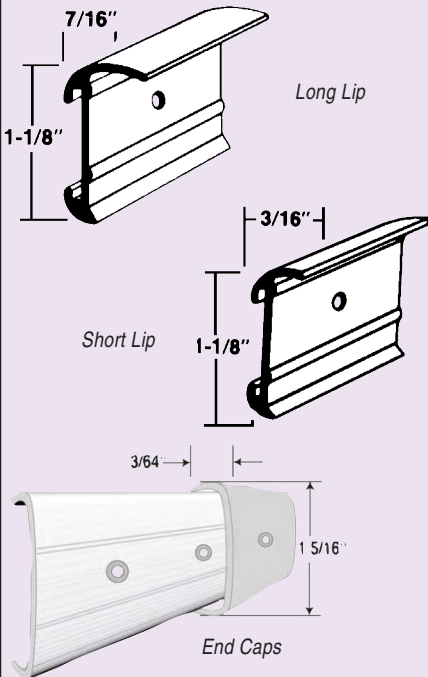

CORNER MOLDING

(Sold only in tube of 10 pieces.)

LONG LIP CORNER MOLDING

Corner Insert Trim
(Sold only in tube of 10 pieces, 20 ft. long):

- 49943 Arctic White #CDS-49943 ◆ 1
- 41122 Colonial White #CDS-41122 ◆ 1
- 41119 Mill Finish #CDS-41119 ◆ 1

SHORT LIP CORNER MOLDING

Standard side insert extruded trim.
(Sold only in tube of 10 pieces, 16 ft. long):

- 49942 Arctic White #CDS-49942 ◆ 1
- 41625 Colonial White #CDS-41625 ◆ 1
- 41624 Mill Finish #CDS-41624 ◆ 1

END CAPS FOR ALL CORNER MOLDING

Ends Caps, Bag/10:

- 49946 Arctic White #CDS-49946 1
- 41135 Colonial White #CDS-41135 1
- 41134 Mill Finish #CDS-41134 1

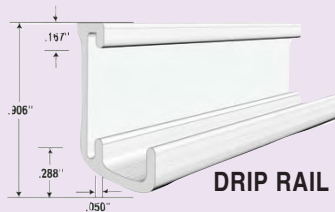

DRIP RAIL

(Sold only in tube of 10 pieces, 16 ft. long.)

Insert Drip Rail, Tube/10, 16ft. L:

- 45051 Tube/10 Insert Drip Rail, Arctic White #CDS-45051 ◆ 1



JR PRODUCTS EXTENDED RAIN GUTTER SPOUTS

These one-piece extended rain gutter spouts are the **longest** on the market and will keep your RV free of black streaks by directing the water away from the sidewalls. The eye pleasing design moves the water volume faster and further away than any other rain gutters spouts. Made of durable plastic with UV inhibitors for years of use. Spouts have a one-piece design so you don't have to use clip-ons. They attach to your RV under the existing aluminum track and never need to be removed.

Extended Rain Gutter Spouts:

- 28439 Rigid, Pk/2 #655-PW-A 1
- 28442 Flexible, Pk/2 #655-FLEX-PW-A 28

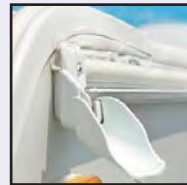

CAMCO GUTTER EXTENSIONS

Helps prevent black streaks from forming by directing rain water runoff away from the sides of your RV. Extenders clip onto your RV gutters.

- 48315 Gutter Extensions, Pk/4 #42123 4

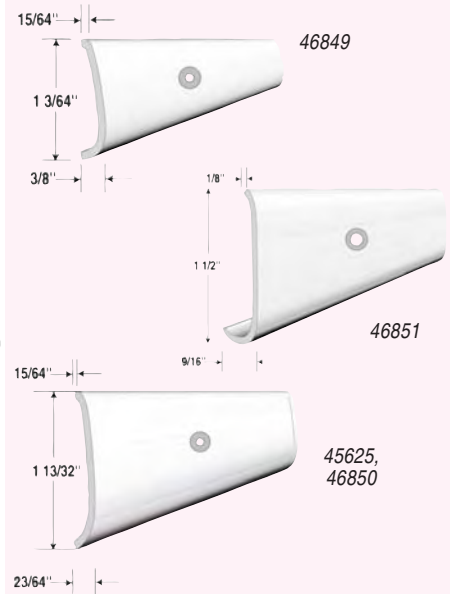

EDGE MOLDING, DRILLED & COUNTERSUNK FOR #8 SCREWS

ARCTIC WHITE

Edge Molding, DC #8, Tube/10:

- 46849 8' #CDS-46849 1
- 46851 10' #CDS-46851 ◆ 1
- 46850 12' #CDS-46850 ◆ 1

COLONIAL WHITE

Edge Molding, DC #8, Tube/10:

- 45625 12' #CDS-45625 ◆ 1

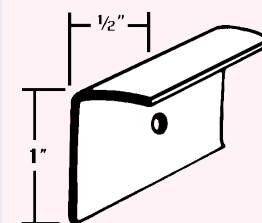

EDGE MOLDING

Standard edge molding. Sold only in tube of 10 pieces, 16 ft. long.

- 41636 Tube/10 Edge Molding, Mill Finish #CDS-41636 ◆ 1



JR PRODUCTS RV GUTTER SPOUT

Gutter spouts easily install to sidewall rain channel ends to eliminate dirty streaks from the side of your RV unit. Fits all manufacturers' rain channels including awning inserts, J-channels.

Drip Spout, Bag/4:

- 49500 Colonial White #389CW-A 1
- 49781 Polar White #389PW-A 1

