



VOLVO XC40

2020



T5 AWD | R-Design
Crystal White Metallic

INNOVATIVE BY DESIGN

Introducing the new Volvo XC40, the compact SUV born from Swedish innovation. Built for city life and designed around you.

Contents

Exterior Design	04	Momentum	24	Features & Packages	42
Interior Design	08	R-Design	29	The Volvo Experience	43
Storage & Versatility	10	Inscription	33	Facts & Figures	44
Sensus	12	Care by Volvo	37	Lifestyle Collection	45
IntelliSafe	18	Overseas Delivery	38		
Powertrains	23	Accessories	40		



WHEN WE INNOVATE, THE CAR IS NOT TOP OF MIND

We admit it. You fascinate us. We think and talk about you all day. Everything about your life – its ups and downs, joys and disappointments, needs, demands, frustrations and hopes – captivates us.

So when we innovate, every detail – from service design right down to the smallest screw – has to justify itself to you. Does it add anything? Is it useful?

We know you always want to feel in control. Our IntelliSafe technologies not only help to save lives, but also give you more enjoyment behind the wheel.

We know you want to stay connected to the world around you. Our Sensus solutions ensure you are.

We also know you care about the future of the planet. That's why our Drive-E technologies allow you to drive sustainably – without compromising on performance.

And we know you're interested in self-driving cars. Each day we take pioneering steps in our quest to deliver a safe and relaxing autonomous driving experience. The same goes for fully electrified powertrains. And even smarter services.

We happily walk the extra mile to give you what you want.

At Volvo, everything we do is designed around you.

You are why we innovate.



YOU'RE IN CONTROL

Experience the feeling of confidence and control on every journey in the XC40, with a high seating position and agile handling that put you in command.



T5 AWD | R-Design
Crystal White Metallic



AN SUV WITH A TWIST

The XC40 is an authentic SUV for the city. High ground clearance, large wheels, and true SUV proportions give it a powerful stance. From the bold front grille to the beautifully detailed taillights, it's every inch a Volvo. Uniquely Scandinavian, it's an SUV built for city life.

T5 AWD | R-Design
Crystal White Metallic | 20" 5-Double Spoke
Matte Black Diamond Cut Alloy Wheels





STAND TALL

High ground clearance gives the XC40 a powerful stance and excellent visibility. Large wheels and tires cope effortlessly with any road. This is the SUV that allows you to rise above it all.

T5 AWD | R-Design
Crystal White Metallic | 20" 5-Double Spoke
Matte Black Diamond Cut Alloy Wheels



STRENGTH OF CHARACTER

The XC40 expresses toughness, and is unmistakably a Volvo, through features such as its proud grille, "Thor's Hammer" light signatures, and sculpted front bumper with skid plate.

ALWAYS READY

Large Alloy Wheels and a wide body give the XC40 a strong presence. This is an SUV that's ready for anything.



MAKE A BOLD IMPRESSION

Make a statement with a choice of contemporary colors. And, depending on trim level, the roof and door mirror housings can be specified in a contrasting color for an even bolder look.

LIGHTING WITH DISTINCTION

See and be seen, day or night, with standard LED headlights that feature the XC40's own take on Volvo's unique "Thor's Hammer" light signature. They automatically adjust the beam height, and switch between dipped and full beam, to provide the best view and avoid dazzling other road users. The optional high-level LED headlights include active bending lights that turn with the steering (by up to 30°) to provide a better view around corners.



SPECIALLY DESIGNED ALLOY WHEELS

A selection of Alloy Wheels helps you to create your perfect XC40. Each one has a bold, dynamic design, as well as the attention to detail and high-quality finish you expect from a Volvo.



AN INTERIOR TO INSPIRE

Bold, progressive design is the hallmark of the Volvo XC40, and the cabin embodies forward-thinking Scandinavian style. An uncluttered layout lets you focus on the beautiful details, while the high seating position means you always feel in control. Carefully crafted and selected materials indulge the senses, and intuitive technology puts you in command. The cabin of the XC40 is a place that will inspire you on every journey.

T5 AWD | R-Design
Perforated Fine Nappa Leather/Nubuck, Charcoal |
Lava Interior Carpeting (Optional) | Cutting Edge Aluminum Decor Inlays

BEAUTY IN DETAIL

It's the details that set Volvo Car's interiors apart. The thought, effort, and craftsmanship that go into the smallest elements in the cabin of the XC40 help to create a unique and special feeling each time you climb inside.

T5 AWD | R-Design
 Perforated Fine Nappa Leather/Nubuck, Charcoal |
 Lava Interior Carpeting (Optional) | Cutting Edge Aluminum Decor Inlays

Natural light from the panoramic roof, our characteristic frameless rear-view mirror, and LED lighting on the distinctive concave decor panels on the dashboard are just a few of the visual highlights in a cabin designed to look great – and to make you feel good.

DOOR HANDLES

The bold, finely crafted door handles in the XC40 echo those in our larger SUVs, while their metallic finish feels great to the touch. The XC40 is a car that rewards all your senses.



T5 AWD | Momentum
 Thunder Grey Metallic with Optional White Contrast Roof



LAVA CARPETING

One of the highlights of the R-Design variant is the availability of Lava carpeting and door inserts. It has a rich, bold color that perfectly expresses the youthful character of the XC40.

LED LIGHTS

The XC40 is available with Interior High Level Illumination that highlights the beautifully sculpted dashboard and stylish decor panels at night.

SUSTAINABLE BEAUTY

Made from 100% recycled material, the textile interior mats of the XC40 combine modern style with a sustainable, environmentally responsible approach.

AIR VENTS

The air vents in the XC40 are an example of our designers' ingenuity, with an innovative design that combines a beautiful minimalist appearance with effortless functionality.



PANORAMIC MOONROOF

The interior of the XC40 is shaped by a uniquely Swedish appreciation of light. A panoramic roof floods the interior with natural light by day. (Optional on Momentum, the Panoramic Moonroof is a standard feature of R-Design and Inscription models.)

REALLY CLEVER STORAGE

The inventive storage solutions in the XC40 are the result of us listening to our customers and understanding what they want from their cars. The front door pockets are each large enough for a laptop, handbag, or even three large bottles. This feature is made possible by Air Woofer Technology™, a

Volvo Cars innovation that uses an audio speaker mounted behind the dashboard, rather than in the doors, to free up space where you need it most. It's just one of the many ways that the XC40 helps to make every day easier.



WIRELESS PHONE CHARGING

There's a space beneath the center touchscreen where a mobile phone can be stored and wirelessly charged, helping to reduce clutter and making it easy to reach when you need it. (Optional)

T5 AWD | R-Design
Perforated Fine Nappa Leather/Nubuck,
Charcoal | Lava Interior Carpeting (Optional) |
Cutting Edge Aluminum Decor Inlays

LARGE DOOR BINS

Doors free of speakers mean that the pocket is large enough to fit a laptop or three large bottles.



CARD HOLDERS

Card holders integrated neatly into the dashboard allow you to keep a credit card or parking voucher easily within reach. For increased security, there is an additional card holder hidden discreetly in the front center console.



SMART STORAGE

The storage bin under the front center armrest is large enough to hold a small handbag or even a full-size tissue box, and has a removable wastebasket in front of it.



BAG HOOK

Keep a small bag or takeout food secure with a hook that folds neatly out of the glovebox and prevents items from moving around or spilling while you're driving.

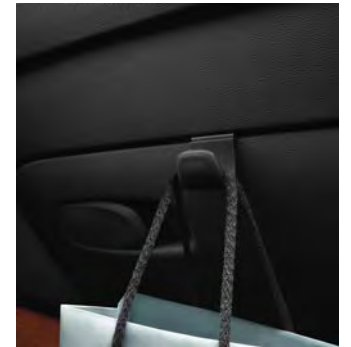

T5 AWD | R-Design
 Crystal White Metallic | 20" 5-Double Spoke
 Matte Black Diamond Cut Alloy Wheels



Go hands-free

When your hands are full, the power-operated tailgate on the XC40 makes life easy. And when combined with the keyless entry option, it means you only need to move your foot under the rear bumper to open or close it automatically.



The right fit

The XC40 helps you fit your life into your car. The load compartment is one of the largest in its class, with a regular shape that makes it easy to load and helps make the most of the space. The folding load floor helps you adapt it to whatever you're carrying.

A VERSATILE SPACE

Everything starts with people at Volvo Cars – it's why we look, listen, and design cars around their needs. And it's why the XC40 is full of practical, versatile features that help you carry what you want as easily as possible. Load and unload your car with ease thanks to a large cargo area that can be accessed by a hands-free power-operated tailgate. If you need to carry bulky or unusually tall items, you can take advantage of the foldable, removable load floor. And if you need even more space, the rear seat backrests fold completely flat.

Valuable items can be stored securely out of sight under the load floor. And to make the load area as versatile as possible, the folding floor can be placed in multiple positions. There are also four load-securing tie-downs to keep delicate items safe and to protect the car's occupants, plus three bag hooks that ensure your shopping doesn't move around or spill in transit. Whatever type of load you need to carry – large or small – your XC40 helps make it effortless.

T5 AWD | Momentum
 Fusion Red Metallic | 19" 5-Spoke Black
 Diamond Cut Alloy Wheels

IN SYNC WITH YOU



Every interaction in the XC40 feels natural and intuitive. From the easy-to-use 9" Sensus Touchscreen to the high-resolution 12.3" Digital Driver Display and voice control that understands normal speech, the standard technology is there to make things simple.

It's as familiar and intuitive as using your phone. You can control most functions via the 9" Sensus Touchscreen – its portrait format and bold, clear graphics make it easy to read, and it's so responsive that you can use it wearing gloves. Standard Apple CarPlay® and Android Auto® help keep you connected when on the move.

The 12.3" Digital Driver Display helps you stay focused on the road ahead by putting all the information you need directly in front of you. And it automatically adapts to the surrounding light conditions, becoming brighter or dimmer depending on the light coming from outside the car.

Your guide

Sensus Navigation is your guide, helping you to find your destination and keeping you informed. With clear mapping, free lifetime map upgrades, and the availability of apps that help you find what you're looking for and share your location, you can enjoy the journey ahead.

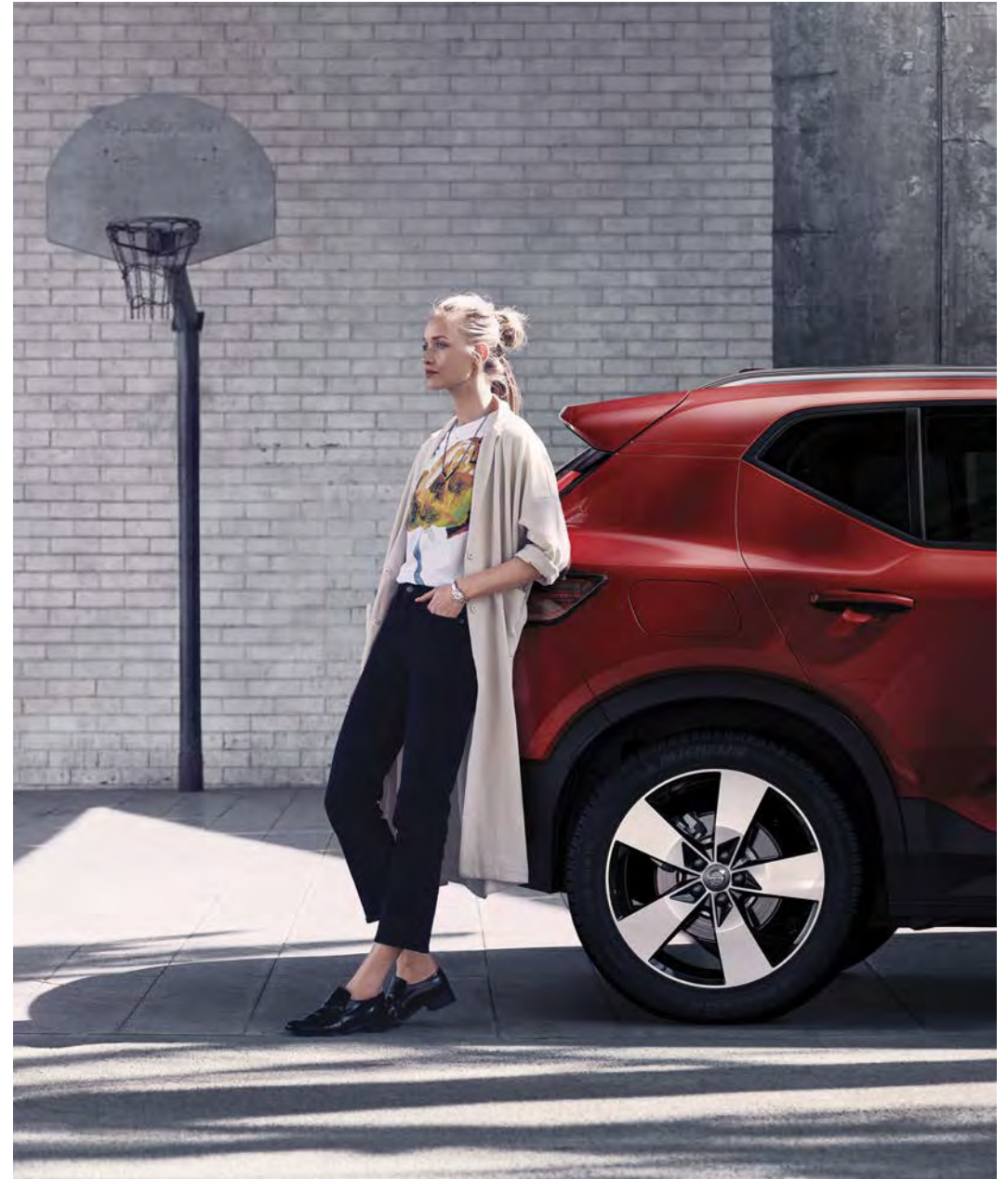

T5 AWD | R-Design
 Crystal White Metallic | 20" 5-Double Spoke
 Matte Black Diamond Cut Alloy Wheels



DESIGNED FOR SOUND

We understand that music can make the difference, and the XC40 has been engineered to let you enjoy your favorite music to the fullest. Every XC40 features Air Woofer Technology™ that delivers precise, powerful bass.

For an even more immersive experience, choose the optional Harman/Kardon® Premium Sound audio system. A collaboration with one of the world's leading audio brands, it features 13 speakers and 600 watts for a beautifully balanced, powerful sound.



All about the bass

The XC40 features Air Woofer Technology™ – a new type of audio speaker that brings you precise sound and great bass reproduction. And because it's mounted behind the dashboard, rather than in the doors, it frees up the cabin for valuable extra storage space.



Streaming. On demand.

Access to streaming services is just a touch or a voice command away in the XC40. Standard Apple CarPlay® and Android Auto® means that you can easily listen to music, news, and audiobooks via your favorite apps.



Harman/Kardon® Premium Sound

Enjoy your favorite music to the fullest with the available Harman/Kardon® Premium Sound system in the XC40. This top-of-the-range audio system draws on the expertise of one of the world's leading audio brands to provide powerful, detailed sound.

VOLVO ON CALL

Your personal assistant

The Volvo On Call app connects your car with the rest of your world, helping make life less complicated. It's there when you need it, so your car becomes more than just a means of travel – it's your personal assistant.

You can use it to make your car ready for the drive to the office, or the drive home, by using remote start to heat or cool the cabin. It can even accept packages on your behalf. You can sync your Volvo On Call app with your calendar, so if you've got appointments it will tell your car where they are and how to get there. And it keeps you safe, automatically contacting emergency services if you're involved in an accident and telling them where you are.



YOUR DAY MADE EASIER WITH VOLVO ON CALL

From saving you time in the morning to helping you relax on the way home, Volvo On Call becomes an indispensable part of your daily routine.

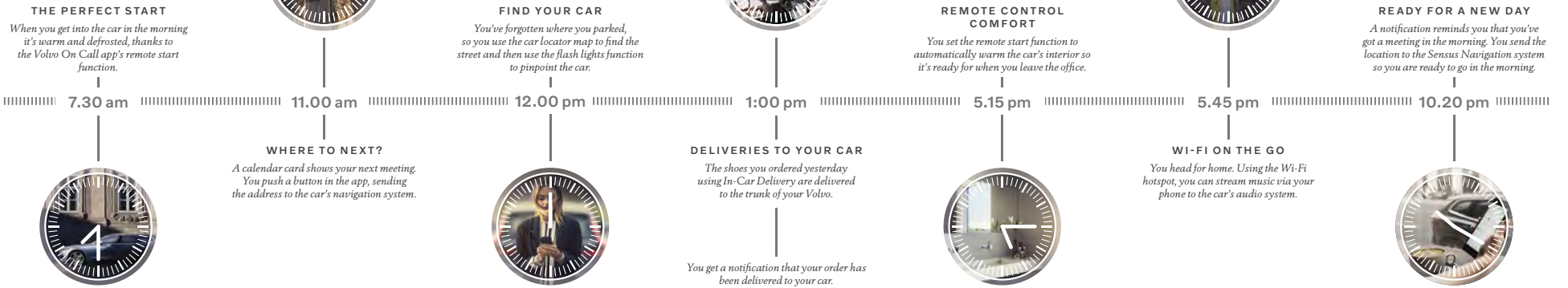
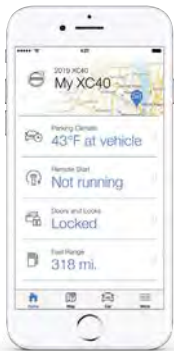



CONNECTED. CONVENIENT.



By combining the connectivity of your XC40 with your mobile device, the XC40 can become more than just a means of transport. Thanks to the Volvo On Call app and Sensus Connect, you have access to a range of connected services that make your car a life hub for you, your family, and your friends.

The remote engine start lets you begin every drive in comfort. Heat and defrost your car on cold mornings and cool your car on hot days, before you even get in. You can also check if a window or the tailgate is open, and see if your car is locked, then lock it or unlock it, directly from your smartphone.

Your entertainment options are not limited to what's available on your smartphone. Wi-Fi and tethered internet enable you to utilize a fast and stable connection through the antenna. Sensus goes even further, with built-in apps

that keep a world of music at your fingertips, keeping your devices connected to the internet, while audio systems offer considerable flexibility when it comes to your sound.

Our new car sharing offer is another innovative service. It allows you to share your car – and the services that go with it – by granting access to friends, family members, or colleagues through their mobile device and the Volvo On Call app. Once they have opened the car, the special key in the cabin is activated and they can use this to lock, unlock, and drive the vehicle. Not having to meet up and hand over a physical key opens up a world of possibilities – it means that a friend or colleague can access or borrow your car, wherever you are and wherever your car is. It's connected thinking for a connected world, by Volvo Cars.

EXPERIENCE CONTROL

The XC40 has a high seating position that puts you in command and gives you a great view of the road ahead. It's a car that elevates you above the everyday, with thoughtful, uncluttered design that means you always feel in control behind the wheel. Standard

intuitive technology is there to make your life less complicated – the easy-to-use 9" Sensus Touchscreen is so responsive that you can use it wearing gloves, while the high-resolution 12.3" Digital Driver Display looks great and is easy to use in any light.



The human touch
At the heart of the cabin is our 9" Sensus Touchscreen – a feature familiar to the new generation of Volvo cars that blends beautiful design with ease of use. The portrait format makes reading information – and following navigation – especially easy.



TECH THAT HELPS

Every journey is easy in the XC40, thanks to a range of helpful Volvo Cars innovations. Pilot Assist makes driving in heavy traffic less tiring. It helps you keep a set distance from the vehicle in front, and uses small steering inputs to help you keep the car in the center of the lane at speeds of up to 80 mph. Adaptive Cruise Control lightens the load by keeping the XC40 at a set distance from the car in front; you set the gap and the XC40 will adapt its speed to maintain that distance.

Please note: The driver is always responsible for how the car is controlled, these are only supportive functions.

T5 AWD | R-Design
Crystal White Metallic | 20" 5-Double Spoke
Matte Black Diamond Cut Alloy Wheels

CITY SAFETY

Protecting what's important

Volvo Cars is synonymous with safety, and the advanced features in the XC40 are the result of decades of experience and innovation – they are there to help you avoid a collision and protect you and your passengers if one should occur.

At the heart of everything is standard City Safety. This innovation identifies other vehicles, pedestrians, cyclists, and large animals ahead, even at night, and warns you if a collision is imminent. If you don't react in time, it will apply the brakes automatically to help avoid or mitigate a collision.



Oncoming Lane Mitigation
Using automatic steering assistance, this system helps you avoid collisions with oncoming vehicles. If you drift across the lane markings in the way of an oncoming vehicle, your car steers back.

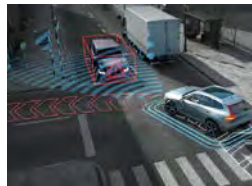

Intersection Braking
City Safety includes an intersection braking function that can help to make an accident at a road junction less likely or less harmful. This feature – a world-first when it was introduced in the Volvo XC90 – automatically brakes the car if the driver turns into the path of an oncoming vehicle.



Rear collision Warning
Included as part of the IntelliSAFE Surround option, our rear collision warning system works to protect you if it detects a risk of a collision from behind. Just before a collision, the system will automatically tension the prepared front seat belts and, if your car is at a standstill, will also activate full autobraking to help reduce the risk of whiplash injury.



Run-off road Mitigation
Our Run-off Road Mitigation technology helps to keep you safe by keeping you on the road. If this innovation detects you are about to leave the road unintentionally at any speed between 40-86 mph, it uses steering input and, if necessary, brake support to guide you back on track.



Lane Keeping Aid
Fitted as standard, this feature monitors the road ahead and gently steers the car back into its lane if it detects that you're about to cross a lane marking unintentionally. If the car's steering adjustment isn't enough, or if you cross into the other lane, you'll be alerted by gentle vibrations through the steering wheel.



BLIS™
Our Blind Spot Information technology makes journeys safer and less stressful by providing better awareness of traffic on the highway. It uses radar sensors to monitor the road behind and to the side of you, and warns you of vehicles that are approaching or alongside you, to help reduce the chance of a collision.

SAFER THAN EVER

Protecting you and your passengers has always been at the heart of every Volvo car, and the advanced safety features in the XC40 are the result of our decades of innovation.

As with all of our cars, the XC40 surrounds you with strength. The passenger compartment uses a high percentage of ultra high-strength boron steel to create a protective cage around you and your passengers. Specially designed front seat structures minimize the risk of spinal injury on impact. The front seats incorporate our Whiplash Injury Protection System to minimize the risk of neck injuries if the car is hit from behind.

If your XC40 leaves the road, Run-Off Road Mitigation reduces your chance of serious injury. And front seat belts automatically tighten if the car senses that an impact is imminent, putting you in the safest possible position if a collision occurs. All this, and more, makes the XC40 a safe place to be.



PARKING MADE EASIER

Parking is easy in the XC40 thanks to its compact dimensions, elevated seating position, and responsive steering – and technology is there to help. The 360° SurroundView Camera available for the XC40 uses the images from discreetly mounted cameras to create a view of the car as seen from above. It allows you to clearly see where the car is in relation to other vehicles and objects, helping you to avoid them.

Park Assist Pilot is a self-parking function that can steer the XC40 into a parallel space just 1.2 times the car's length, or into a standard

parking spot. All you need to do is follow the car's instructions to operate the accelerator and brakes.

Park Assist Pilot also helps you find a space, by alerting you if one is big enough as you drive by it. Cross Traffic Alert (CTA) with Autobrake makes reversing out of spaces safer. Radar sensors in the rear bumper detect whether you are about to reverse into the path of an oncoming vehicle, cyclist, or pedestrian. If it detects something, it will warn you, then brake if necessary to avoid or mitigate a collision.



A better view

The 360° SurroundView Camera available for the XC40 gives you a detailed bird's-eye view of your car from above, so you can see where it is in relation to other vehicles and objects. It's especially useful in tight spaces and crowded parking lots, and helps you keep your car free from scrapes.

An App that Helps

The Volvo On Call app allows you to find your car in a busy parking lot by briefly activating the lights and horn remotely.

T5 AWD | R-Design

Crystal White Metallic | 20" 5-Double Spoke
Matte Black Diamond Cut Alloy Wheels

AGILE. RESPONSIVE. IN CONTROL.

Wherever you take your XC40, you'll always feel in control. Enjoy agile, energetic responses from behind the wheel – whether you're in the city or out on the open road – thanks to a sophisticated suspension that makes extensive use of lightweight aluminum. Selectable drive modes allow you to set your car's responses to suit your mood, adjusting settings for the engine, transmission, Electronic Stability Control, steering, and Start/Stop function. The optional Four-C chassis features electronically controlled suspension dampers for an even greater degree of versatility and control over how your XC40 drives. Models equipped with All-Wheel Drive (AWD) give improved traction, for the most efficient acceleration from a standstill and an even more secure feel in slippery conditions or when towing. Hill Descent Control makes descending steep or slippery slopes as safe as possible.

Smart powertrains give you the responsiveness you want with low emissions and fuel consumption – there's no need to compromise. It's all thanks to our Drive-E family of sophisticated turbocharged engines. These compact, lightweight powertrains balance smooth power with efficiency. And they keep weight at the front of the car to a minimum, which improves handling agility.

Power is transmitted to the road by a highly efficient, smooth-shifting 8-speed automatic transmission. On R-Design models, steering wheel-mounted paddles allow you to shift gears effortlessly. The XC40 allows you to take control, and inspires confidence, however long or short the journey.

T5 AWD | R-Design
Crystal White Metallic | 20" 5-Double Spoke
Matte Black Diamond Cut Alloy Wheels





YOUR JOURNEY BEGINS HERE

We created the new XC40 with one single purpose: to provide you with a city SUV that perfectly fits you and your lifestyle. It's a car that meets your expectations of a fun, agile drive with exceptional comfort and distinctive Scandinavian design – built with care for people and the world we share. Designed to be intuitive to use and to make life easier, the XC40 is a pleasure to live with every day.

At the heart of your XC40 is an efficient, responsive powertrain. Whichever you choose, you will enjoy our latest Drive-E technology that gives you

responsive power. Fuel consumption and CO₂ emissions are kept low, and our powertrains already comply with future exhaust emission legislation.

All engines are mated to our 8-speed Geartronic™ automatic transmission for a smooth and intuitive drive. On T5 AWD, our responsive all-wheel drive technology gives you an edge by increasing driving stability and traction – on all road surfaces and in all weathers. Make your choice, and enjoy wherever the journey takes you.

T5 AWD | R-Design
Crystal White Metallic | 20" 5-Double Spoke
Matte Black Diamond Cut Alloy Wheels



T4 FWD

The turbocharged 187 hp/221 lb-ft T4 FWD powertrain allows you to enjoy more while using less. Drive-E engine technology, our 8-speed Geartronic™ automatic transmission, and front-wheel drive add to instant control and an efficient driving experience.

T5 AWD

The powerful 248 hp/258 lb-ft T5 AWD powertrain is as responsive on the highway as in the city. This superb all-rounder delivers generous power just where you need it, ensuring excellent driveability thanks to our smooth 8-speed Geartronic™ automatic transmission and all-wheel drive.

**MOMENTUM**

Strong, contemporary style with a confident look, available in contrasting color combinations.

**R-DESIGN**

Inspired by performance, with sporty design in every detail, inside and out.

**INSCRIPTION**

A highly sophisticated expression of modern Swedish luxury.

CREATE YOUR OWN SWEDISH CITY SUV

Our approach in everything we do is to always put people first. This includes allowing you the freedom to create a Volvo that reflects your individuality and fits perfectly into your life.

Inspired by the pulse of city life and fashion, the new XC40 is just as individual as you are. You have three different design expressions to choose from – each with its own style and character: the contemporary, vivid Momentum; the powerful, sporty R-Design; and the distinctive, luxurious Inscription.

Whatever you prefer, you can rest assured there's a Volvo XC40 for you. Read on, and choose the design of your new XC40.

T5 AWD | R-Design

Crystal White Metallic | 20" 5-Double Spoke
Matte Black Diamond Cut Alloy Wheels



MOMENTUM

Contemporary city style

Momentum is a proud expression of city style, where smart features and contemporary design interact to create a confident and bold look. Designed and built for a better life, the XC40 Momentum is equipped with everything you need for successful living. Exterior details in bright chrome, paired with window surrounds in gloss black, enhance the expression of modernity. The exterior is available in a range of solid and metallic full-body colors, each with a distinctively contemporary look. And to really stand out from the crowd, most of the exterior body colors are available with a contrasting white roof, white door mirror caps, and wheels with white spokes.

On the inside, you can relax in the ergonomically designed seats with standard leather upholstery. Many different interior color combinations make it easy to tailor your own, personal XC40 experience.

XC40 MOMENTUM

Includes:

Exterior:

18" Alloy Wheels | Grille in Dark Grey with Chrome Frame | Clamshell Hood | Contrasting White Roof (Optional) | Bright Integrated Roof Rails | Dynamic Chassis | Color Adapted Door Mirror Covers | LED Headlights | Silver Skid Plate | Hidden Tailpipes

Interior:

8-Way Power Driver Seat with Driver Seat Memory | 4-Way Driver Seat Power Lumbar Support | Urban Grid Aluminum Decor Inlays | Leather Steering Wheel | Leather Gear Knob | Textile Mats | Power Tailgate | Tailgate Scuff Plate | Volvo On Call | Interior Mid Level Illumination | 12.3" Digital Driver Display | 9" Sensus Touchscreen | 250 watt High Performance Audio System with 8 Speakers, including Air Woofer Technology™ | Auto Dimming Rearview Mirror

T5 AWD | Momentum

Fusion Red Metallic | 19" 5-Spoke | Black White Alloy Wheels

DESIGNED FOR THE CITY

Everything about the XC40 Momentum is self-assured and confident. It's a genuine SUV with a Scandinavian twist. The optional white roof and many interior combinations allow you to tailor a Volvo SUV that reflects your personal style and preferences. The leather upholstery, the concave Urban Grid Aluminum Decor, and the sophisticated interior lighting add a touch of luxury to the interior ambiance.

T5 AWD | Momentum

Thunder Grey Metallic with Optional White Contrast Roof | 19" 5-Spoke Black Diamond Cut Alloy Wheels



The front of the XC40 Momentum is distinctively defined by the grille in dark grey and its frame in bright chrome.



The signature design "Thor's Hammer" LED headlights, the bright integrated roof rails, and the optional contrasting white roof, white door mirror caps, and 19" White Spoke Alloy Wheels make the XC40 Momentum equally at home in all environments.



The silver skid plate with hidden tailpipes gives a robust yet stylish impression from behind.

T5 AWD | Momentum

Leather Blond, Charcoal Headlining (Optional) | Urban Grid Aluminum Decor Inlays



The XC40 Momentum interior with leather seats, concave Urban Grid Aluminum Decor, leather steering wheel, and textile mats reflects the essence of beautiful Scandinavian design.



The concave Urban Grid Aluminum Decor enhances the modern interior ambiance of the XC40 Momentum.



The leather seats are ergonomically designed to provide excellent comfort wherever you go.



The 12.3" Digital Driver Display and the 9" Sensus Touchscreen put you in total control of your drive.

The wide range of exterior colors and wheels allows you to create a city SUV that's really you. The large 18" 5-Spoke Silver Alloy Wheels come standard. To further enhance the appearance of your XC40, you have the option of 19" or 20" wheels in distinctive Black Diamond Cut design, or with white spokes that perfectly complement the optional white roof. You can have your XC40 in many different full-body colors, where each color imbues your Volvo with a sense of contemporary Scandinavian design.



20" 5-Spoke
Black Diamond Cut Alloy Wheels, 917
(Optional)



19" 5-Spoke
Black Diamond Cut Alloy Wheels, 922
(Optional)



18" 5-Spoke
Silver Alloy Wheels, 921
(Standard)



614 Ice White



717 Onyx Black Metallic



019 Black Stone



725 Fusion Red Metallic



728 Thunder Grey



729 Glacier Silver

CONTRASTING WHITE ROOF
For a unique look, most of the exterior colors are available with a contrasting white roof.



728 Thunder Grey



717 Onyx Black Metallic



019 Black Stone



725 Fusion Red Metallic

For a contemporary look and feel, the XC40 Momentum features Comfort Seats with exclusive leather upholstery available in several different interior color combinations to suit your personal preferences. The interior ambiance, day and night, is further enhanced by the concave Aluminum Decor in rectangular Urban Grid pattern.

Textile Blond, U470



Charcoal Textile, R300,
Charcoal Headlining (Optional)



Leather Amber, RD20



Leather Blond, UD70

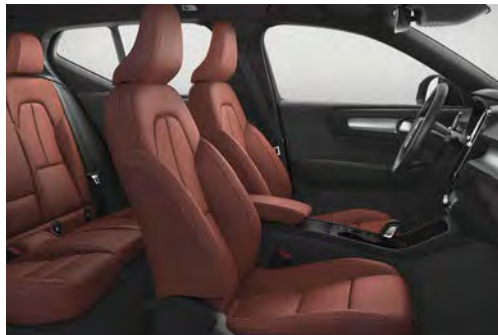

Leather Charcoal, RD00

Leather Oxide Red, RD90



Urban Grid Aluminum Decor Inlays, 437

Leather Blond, UD70,
Charcoal Headlining (Optional)

Available in distinctive upholstery colors such as Oxide Red, the leather Comfort Seats allow a wide range of adjustment possibilities, including 4-way power lumbar support.



R-DESIGN

The sporty look

The R-Design captures the sporty soul of your XC40, with a black color theme including the roof and other distinctive exterior design details. The large Alloy Wheels enhance the car's road presence and add to the powerful look. It's an expression that catches the eye from every angle, and hints at the promise of an amazing drive.

Inside the driver-focused Charcoal interior, you're surrounded by bespoke materials and trim. Your body is comfortably supported by the R-Design seats in Perforated Fine Nappa Leather/Nubuck upholstery. Everything – from the R-Design Sport Steering Wheel with shift paddles to the Charcoal headliner – is there to inspire and put you in control. And unique for R-Design, the optional Lava interior carpeting creates a youthful, stylish ambiance that will energize your every drive.

XC40 R-DESIGN

Includes Momentum features plus:

Exterior:

Panoramic Moonroof | 19" Alloy Wheels | R-Design Grille with Gloss Black Frame | Gloss Black Roof with All Exterior Colors | Gloss Black Integrated Roof Rails | Gloss Black Door Mirror Covers | Gloss Black Window Trim | Gloss Black Skid Plates | Dual Integrated Tailpipes | LED Foglights | C-Pillar R-Design Molding | Sport Chassis

Interior:

R-Design Perforated Fine Nappa Leather/Nubuck Upholstery | 8-Way Power Front Seats with 4-Way Power Lumbar Support and Driver Seat Memory | Manual Cushion Extensions | Cutting Edge Aluminum Decor Inlays | Lava Interior Carpeting (Optional) | R-Design Sport Steering Wheel | Steering Wheel Shift Paddles | R-Design Leather Gear Knob | R-Design Pedals | R-Design Textile Mats | Charcoal Headlining | Interior High Level Illumination | R-Design Metal Front Tread Plates | R-Design Leather Key Fob | Keyless Entry with Hands-free Tailgate Opening | Stainless-steel Cargo Scuff Plate | Navigation Pro | 2-Zone Automatic Climate Control

FOR A COMPLETE EQUIPMENT LIST, PLEASE VISIT VOLVOCARS.COM/US

T5 AWD | R-Design
Crystal White Metallic | 20" 5-Double Spoke
Matte Black Diamond Cut Alloy Wheels



INSPIRED BY THE ART OF DRIVING

R-Design is our sportiest expression, characterized by dynamic contrasts and a confident presence. Unique exterior design details in black, such as the front grille, the roof, and the door mirror caps, together with large Alloy Wheels, make it possible to create a truly distinctive look. The sporty theme continues on the inside, with R-Design Perforated Fine Nappa Leather/Nubuck seats, concave Cutting Edge Aluminum Decor, and optional Lava carpeting. A sport chassis ensures you're in control with maintained ride comfort.

T5 AWD | R-Design
 Crystal White Metallic | 20" 5-Double Spoke
 Matte Black Diamond Cut Alloy Wheels



The gloss black roof creates a strong character – depending on your choice of exterior color, it can make a dramatic impact on the look of your XC40. The embossed R-Design logo in the rearmost door pillar makes a subtle yet distinct statement about the car you drive.



The optional 20" 5-Double Spoke Alloy Wheels in distinctive Matte Black Diamond Cut design add to the powerful stance and work in perfect harmony with the signature design Thor's Hammer LED headlights and gloss black design elements.

The R-Design grille features a gloss black frame with a high-gloss black insert with a horizontal mesh, which complements the gloss black mirror caps, for a unique look.



From the rear, the integrated dual tailpipes and gloss black rear skid plate add to the impression of sporty elegance.



Enjoy the dynamic feeling inside your XC40 R-Design. The Charcoal interior with optional Lava carpeting and door inserts create energizing contrasts, while the exclusive R-Design seats, the Cutting Edge Aluminum Decor, and the R-Design Leather gear knob with white stitching enhance the car's sporty soul.



The concave Cutting Edge Aluminum Decor with integrated LED lighting creates a sporty, exclusive ambiance inside your XC40 – day and night.



Upholstered in exclusive Perforated Fine Nappa Leather/Nubuck, the multi-adjustable R-Design seats provide generous body support wherever you go. Contrasting white stitching and piping adds to the sporty ambiance, while the manual seat cushion extensions provide extra thigh support.



The driver-focused R-Design interior with R-Design sports steering wheel in Perforated Leather, R-Design leather gear knob, aluminum sport pedals, and shift paddles put you in the center of the action.

The exterior color you choose for your XC40 R-Design makes a big impact on the visual expression. Crystal White Metallic with the contrasting gloss black roof gives a cool, robotic look, while the Black Stone exterior color adds to a more sleek, powerful style – especially with the large 20" Alloy Wheels in Matte Black Diamond Cut.



707 Crystal White Metallic

GLOSS BLACK ROOF
On the XC40 R-Design, the roof is always in black. This makes a bold statement, while it perfectly matches the car's other black exterior design elements.



19" 5-Double Spoke
Matte Black Diamond Cut, 911
(Standard)



20" 5-Double Spoke
Matte Black Diamond Cut, 920
(Optional)



729 Glacier Silver Metallic



720 Bursting Blue Metallic



728 Thunder Grey Metallic



019 Black Stone



725 Fusion Red Metallic

The R-Design interior in Charcoal is the perfect environment for a dynamic driving experience. The sporty cockpit feel is further enhanced by the Charcoal headlining, while the optional Lava carpeting and door inserts add a powerful twist.

▼ Cutting Edge Aluminum Inlays, 480

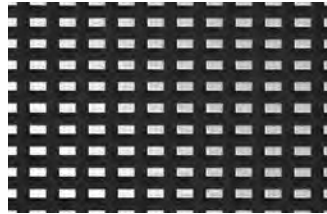

▼ Perforated Fine Nappa Leather/Nubuck, Charcoal, RB00 | Lava Interior Carpeting, (Optional)



▼ Perforated Fine Nappa Leather/Nubuck, Charcoal, RB00 (Standard)

▼ The R-Design seats are upholstered in a stylish combination of Perforated Fine Nappa Leather and Nubuck with contrasting white seams and piping for a truly sporty look and feel.





INSCRIPTION

Modern Swedish Luxury

We created the XC40 Inscription to give you a new take on Swedish luxury. It's about stylish detailing and a meticulously crafted interior with fine, authentic materials – all to give you the very best of contemporary Scandinavian design.

The exterior hints at the experience that awaits you inside the XC40 Inscription. Four unique metallic body colors, tastefully composed chrome details, skid plates in silver finish, and unique Black Diamond Cut Alloy Wheels make for a harmonious and distinctive look.

Inside the XC40 Inscription you can relish exclusive leather seats, surrounded by thoughtful design and natural materials such as the exclusive handcrafted Driftwood Inlays. A large exterior color palette and many available interior color combinations make it easy to create the XC40 Inscription that suits your personal style.

XC40 INSCRIPTION

Includes Momentum features plus:

Exterior:

Panoramic Moonroof | 18" Black Diamond Cut Alloy Wheels | Inscription Grille in Chrome | Bright Integrated Roof Rails | Stainless Steel Scuff Plate | Bright Window Trim, Lower Part | LED Foglights | Matte Silver Skid Plates | Dual Integrated Tailpipes | C-pillar Inscription Molding

Interior:

Leather Upholstery | 8-Way Power Front Seats with 4-Way Power Lumbar Support and Driver Seat Memory | Manual Cushion Extensions | Driftwood Inlays | Inscription Leather Key Fob | Keyless Entry with Hands-free Tailgate Opening | Stainless-steel Cargo Scuff Plate | Navigation Pro | Interior High level Illumination | Metal Front Tread Plates | Orrefors® Crystal Gear Knob | 2-Zone Automatic Climate Control

FOR A COMPLETE EQUIPMENT LIST, PLEASE VISIT VOLVOCARS.COM/US

CONTEMPORARY LUXURY

The XC40 Inscription offers you luxury with a contemporary Swedish twist. Perfectly blending into city life, its stylish exterior with chrome detailing and large Black Diamond Cut Alloy Wheels adds to a confident appearance wherever you go. And for the experience inside, leather seats and genuine Driftwood Inlays provide a relaxed, pampered feeling on every drive.

T5 AWD | INSCRIPTION
Denim Blue Metallic | 19" 5-Double Spoke Black Diamond Cut Alloy Wheels (Optional)



The chrome lower window frames and the integrated roof rails in bright aluminum add an illuminating touch to the exterior of your XC40 Inscription. In the rear pillar, the embossed Inscription logotype hints at a new kind of luxury.



Our large 19" 5-Spoke Black Diamond Cut Alloy Wheels enhance the distinct road presence of your XC40 Inscription.

The unique Inscription grille features high-gloss black inserts, vertical chrome bars, and chrome frame. Our signature design LED Thor's Hammer headlights and matte silver finish front skid plate create a distinctive and luxurious look.



The XC40 Inscription radiates style and confidence from any angle, not least from behind with its beautifully sculpted, uncluttered rear section with a matte silver rear skid plate and integrated dual tailpipes.



T5 AWD | INSCRIPTION
Leather Blond, Charcoal Headlining (Optional) | Driftwood Inlays

Experience modern Swedish luxury while sitting inside the XC40 Inscription. Sitting comfortably in genuine leather seats, you can enjoy the sight of handcrafted genuine Driftwood inlays and the Inscription-exclusive Orrefors® Crystal Gearshift Knob.



The stainless steel front tread plates give a sophisticated welcome every time you enter your XC40 Inscription.

Our concave Driftwood Inlays give the look and feel of wood shaped by the natural force of water, wind, and waves. Interior High Level Illumination further enhance the cabin's sophisticated ambiance.



The leather comfort seats are ergonomically designed to provide excellent comfort wherever you go.



The XC40 Inscription exterior with its distinctive design touches expresses the essence of modern Swedish luxury. The wide exterior color palette – including four unique XC40 Inscription body colors – allows you to create the XC40 Inscription that truly reflects your style and personality. Available in several different designs, the large Alloy Wheels connect visually with the exterior design cues to enhance your city SUV's powerful stance and stylish looks.



20" 5-Spoke
Black Diamond Cut Alloy Wheel, 917
(Optional)



19" 5-Double Spoke
Black Diamond Cut Alloy Wheel, 924
(Optional)

18" 6-Spoke
Black Diamond Cut Alloy Wheel
(Standard)



707 Crystal White Metallic

SELECTED INSCRIPTION BODY COLORS
To further enhance the stylish presence of your XC40 Inscription, our designers have selected four dedicated metallic body colors with a uniquely rich and contemporary touch: 707 Crystal White Metallic, 728 Thunder Grey Metallic, 717 Onyx Black Metallic, 727 Pebble Grey Metallic, 729 Glacier Silver Metallic and 723 Denim Blue Metallic.



728 Thunder Grey Metallic



717 Onyx Black Metallic



727 Pebble Grey Metallic



729 Glacier Silver Metallic



723 Denim Blue Metallic

Everything about the XC40 Inscription exudes conscientious design and meticulous craftsmanship. It's a city SUV to be proud of, a feeling that manifests on the inside with considerate features such as Comfort Seats upholstered in fine leather, handcrafted genuine Driftwood Inlays, several interior color combinations, and an Orrefors® crystal gearshift knob making it easy to tailor your very own XC40 Inscription experience.

Leather Charcoal, RD00,
Charcoal Headlining (Optional)



Leather Amber, RD20,
Charcoal Headlining



Leather Blond, UD70,
Blond Headlining



Leather Charcoal, RD00,
Blond Headlining



Leather Oxide Red, RD90,
Charcoal Headlining

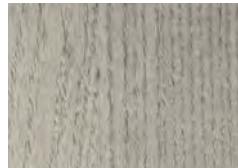

Driftwood Inlays, NC0C



Leather Blond, UD70,
Charcoal Headlining (Optional)

Available in distinctive upholstery colors such as Oxide Red, the leather Comfort Seats allow a wide range of adjustment possibilities, including 4-way power lumbar support.



CARE BY VOLVO A NEW WAY TO GET BEHIND THE WHEEL

Care by Volvo lets you experience the very best a brand-new car has to offer, with extras that complement your lifestyle, while removing all of the downsides of traditional ownership. Forget about taking care of the insurance, maintenance, and service – leave all that to us. One flat monthly fee with no surprises covers all of that. All you need to do is get behind the wheel of your new Volvo and enjoy yourself.

INCLUDES:

- 15,000 Annual Miles
- 24/7 Volvo Concierge
- Roadside Assistance
- Premium Insurance no matter where you live
- Optional Upgrade Every 12 Months

Visit us online at volvocars.us/carebyvolvo to get started with Care by Volvo. The whole process takes place on your phone or computer – choose your colors and your preferred Volvo dealer, and with a simple \$500 deposit (to be applied to your first monthly payment), your car is reserved. From there, our 24/7 Volvo concierge will contact you to schedule delivery of your brand-new Volvo.



ORDER YOURS AT [VOLVOCARS.US/CAREBYVOLVO](https://volvocars.us/carebyvolvo)



VOLVO OVERSEAS DELIVERY

The experience begins in Sweden

Volvo Overseas Delivery is a unique program that gives you an exciting opportunity to pick up your new Volvo from our state-of-the-art factory in Gothenburg, Sweden. But that's just the beginning.

YOUR TRIP INCLUDES:

- A savings off of the US base MSRP, which varies by model
- Opportunity to personalize your new Volvo*
- Complete travel packages for Sweden and/or Europe via our travel concierge, who can help you personalize your adventure
- 2 round-trip airline tickets to Gothenburg, Sweden, via Premium Economy (including private transport upon arrival)
- One overnight stay at a first-class hotel (including dinner)
- Premium delivery at the Factory Delivery Center (including private transport and lunch)
- Guided factory tour
- A visit to the Volvo Museum and/or the Volvo Cars Brand Experience Center
- European car insurance (including Volvo Roadside Assistance and Global Warranty Coverage) for two weeks**
- Home shipment of your new Volvo



T5 AWD | R-Design
Crystal White Metallic



T5 AWD | Inscription
Denim Blue Metallic | 19" 5-Double Spoke
Black Diamond Cut Alloy Wheels

Your adventure begins in Volvo's hometown of Gothenburg, located on Sweden's scenic west coast. Here, you will pick up your new Volvo in person as it rolls out of the factory gate. You will then have the chance to explore the world of Volvo, where you will learn all about the unique culture that inspired the elements of your car.

With Volvo Overseas Delivery, you can custom build and personalize* your new Volvo before taking a once-in-a-lifetime trip to pick it up in the country that built and inspired it. Volvo Overseas Delivery delivers a car that is truly designed around you.

Please note: Changes in the order of your day's schedule may occur.

If you would like to know more about Overseas Delivery, contact your local Volvo Cars Retailer, the Customer Care Center at (800) 631-1667, or visit [VOLVOCARS.COM/US/OSD](https://www.volvocars.com/us/osd)

* Personalization is based on market requirements and specifications. All options / packages and accessories must be US Market-specific.
** Global Warranty coverage remains in effect until your vehicle returns to the States and is registered with Volvo U.S.

T5 AWD | R-Design
Crystal White Metallic



T5 AWD | R-Design
Crystal White Metallic | 20" 5-Double Spoke
Matte Black Diamond Cut Alloy Wheels



YOUR XC40 – THE WAY YOU WANT IT

Create an XC40 that's perfect for the way you live, with impressive Volvo accessories designed around you and your car.

Our range of exterior accessories is carefully crafted to boost the inherent versatility and ruggedness of the XC40. Designed to look good and work flawlessly, they are made from tough, high-quality materials. XC40 accessories are built to withstand everything that life – and the elements – throw at them.

21" 5-TRIPLE OPEN SPOKE BLACK DIAMOND CUT ALLOY WHEELS
For the strongest expression of the tough, sporty character of the XC40, choose our large 21" 5-Triple Open Spoke Alloy Wheel in distinctive Black Diamond Cut design. These impressive, beautifully crafted wheels perfectly complement the uncluttered lines of your Swedish city SUV and give it a truly powerful look.



ROOF SPOILER

This stylish roof spoiler further enhances the sporty character and aerodynamics of your Volvo SUV and is color-coordinated with the roof. Fits perfectly with the exterior styling kit.



EXTERIOR STYLING KIT

Give your XC40 an even more distinctive look with this rugged yet sporty exterior styling kit. The front skid plate, rear skid plate and the lower door trim moldings in brushed stainless steel enhance the powerful stance of your city SUV, while the integrated dual tailpipes add a stylish finish.



BUILT TO BE USEFUL

The interior accessories available for the XC40 are designed to make your Volvo even more practical and durable, so that it's an even more useful part of your life. Whether it's helping you to carry your things as securely and easily as possible, or protecting the interior of your car, our range of accessories

makes life less complicated and allows you to use the full range of your car's capabilities. And because these are Volvo-designed accessories, you can be sure that they're built to last, effortless to use, and fit your XC40 perfectly.

ALL-WEATHER MATS

These durable mats protect the interior of your XC40 from muddy boots and shoes. Shaped to fit the footwells perfectly, they won't slip or shift on the move. Raised edges stop wet and dirt leaking into the car's carpet.



LOAD COMPARTMENT MATS

Accessory load compartment mats help you keep the interior of your XC40 as good as new, whatever you're doing. There's a tough plastic mat with raised edges that's rugged and easy to clean, and a reversible mat that has high-quality textile on one side and durable plastic on the other, to suit differing needs.



STEEL GRILLE

Our strong steel grille provides a sturdy barrier between the passenger and load compartments, preventing unsecured loads from causing harm in the cabin. Fitted using simple attachment points, it helps you transport large or bulky items as safely and securely as possible.

SENSUS

Sensus Connect comes with a host of features as standard equipment: there's the easy-to-use 9" Sensus Touchscreen, the eye-catching 12.3" Digital Driver Display, our High Performance audio system, voice control, and smartphone connectivity options with both Apple CarPlay® and Android Auto®. All this, combined with the standard Volvo on Call and onboard Wi-Fi hotspot means you'll always be able to stay connected, wherever your journey takes you.

And if you'd like to take things a step further, there's a wealth of options. Sensus Navigation incorporates mapping directly into your 9" Sensus Touchscreen and can even display your position and directions in the middle of the 12.3" Digital Driver Display to make finding your way a breeze. Upgrade to the top-of-the-line Harman/Kardon® audio system with 13 speakers and Air Woofer Technology™ and enjoy your favorite songs as they were meant to be heard.

SENSUS CONNECT STANDARD

Includes the following standard features: Includes these standard apps:
(Data trial period or 3 GB included)

- 12.3" Digital Driver Display
- 9" Sensus Touchscreen
- Bluetooth® Audio Streaming
- SiriusXM™ Satellite Radio with Trial Subscription
- Smartphone Integration with an additional USB input (Apple CarPlay® for iPhone® 5 or later, or Android Auto® for Android smartphone 5.0 Lollipop or later)
- USB Inputs
- Wi-Fi Hotspot
- Voice Control
- Steering Wheel Controls
- Tethering via Wi-Fi or Bluetooth®
- 250 watt High Performance Audio System with 8 Speakers, including Air Woofer Technology™
- Volvo On Call with Engine Remote Start 4-Year Complimentary Subscription
- Digital Owner's Manual
- Connected Service Booking

- Pandora™
- Spotify®
- TuneIn (Internet Radio)
- Local Search by Google
- Wiki Locations
- Weather
- Send to Car
- Glympse
- Yelp
- Park&Pay

For more information, please contact your Volvo dealer.

SENSUS CONNECT OPTIONS

- Sensus Navigation Pro

HARMAN/KARDON®

Our top-of-the-line audio system, developed exclusively for your XC40 together with the renowned high-end audio manufacturer Harman/Kardon®:

- 600 watt Harman/Kardon® Premium Audio System with 13 Speakers, including Air Woofer Technology™

INTELLISAFE

Your Volvo XC40 comes with comprehensive IntelliSafe technologies as standard, including all the safety you'd expect from a Volvo and more. You'll also get City Safety, which encompasses technologies designed to help avoid collisions with other vehicles, pedestrians, cyclists, and large animals. City Safety can also autobrake if you're about to turn into the path of an oncoming car in an intersection, while Oncoming Lane Mitigation helps you

avoid collisions with oncoming vehicles by providing automatic steering assistance. Available Pilot Assist supports your driving with semi-autonomous driving technologies in addition to Adaptive Cruise Control.

Add the Vision Package, and you'll get the benefit of technology that alerts you to vehicles approaching in your blind spot or from behind, for your safety and confidence.

INTELLISAFE STANDARD

- Driver Alert Control
- Road Sign Information
- Lane Keeping Aid
- Automatic braking after a collision
- City Safety™ (Vehicle detection, Pedestrian and cyclist detection, Autobrake at intersection, Large animal detection)
- Safety cage
- Seatbelts with reminders on all seats
- Seatbelt pretensioners for all outer seats
- Front, Side & Curtain Airbags; Driver Side Knee Airbag
- Brake pedal release
- WHIPS™ – Whiplash Injury Protection System
- Run-On Road Mitigation
- Run-On Road Protection
- SIPS™ – Side Impact Protection System
- Oncoming Lane Mitigation
- Emergency Crash Notification
- Electronic Stability Control

INTELLISAFE OPTIONS

- Pilot Assist – Semi-Autonomous Drive System with Adaptive Cruise Control (Pilot Assist Driver Assistance System with Adaptive Cruise Control)
- Blind Spot Information System (BLIS) & Cross Traffic Alert with Autobrake (Pilot Assist Driver Assistance System with Adaptive Cruise Control)
- Rear Collision Warning with Braking at Standstill (Pilot Assist Driver Assistance System with Adaptive Cruise Control)
- Park Assist Pilot (Pilot Assist Driver Assistance System with Adaptive Cruise Control)
- Front and Rear Park Assist (Pilot Assist Driver Assistance System with Adaptive Cruise Control)
- 360° Surround View Camera + Visual Park Assist (Pilot Assist Driver Assistance System with Adaptive Cruise Control)

Apple CarPlay® and CarPlay® are trademarks of Apple Inc. Android Auto® is a trademark of Google Inc.

For more information, please see: www.apple.com/ios/carplay/ or www.android.com/auto/

Service By Volvo

Taking care of you and your Volvo is our top priority. With a unique approach to service that's personal, professional and efficient, we get you everything you need in the simplest way possible. To make your life less complicated.

Knowing your vehicle is always up to our highest standards for as long as you own it – that's the driving force behind Service by Volvo. To help you get the most out of your Volvo, we'll ensure each service or maintenance provides peak conditioning through our expertly trained technicians, field-tested repair methods, and precision-engineered genuine parts. That's because we focus on our promises to service your car and simplify your life.

OUR SERVICE BY VOLVO PROMISES

When you have your car serviced at an authorized Volvo dealer, we promise to provide you with a premium ownership experience for the life of your vehicle. Enjoy our Lifetime Parts and Labor Warranty,* so you pay only once, knowing your car is always up to our highest standards. Get technical software updates** and more. No sign-up required.



* Excludes consumable parts due to normal wear. See dealer for details. Non-transferable.

** New software required as part of a repair or accessory installation is not included.

The most carefree way to own a car

LEASING OPTIONS

FLEXIBLE TERMS

Leasing is available for terms as short as 24 months or up to 48 months. You can drive a new Volvo car every few years while within the manufacturer warranty and maintenance plans, and without the burden of negotiating trade-in values.

CHOICE OF MILEAGE PLANS

The standard mileage option allows up to 15,000 miles per year; however, several other mileage plans are available to tailor to your commuting needs. Under the low mileage plan options are available as low as 7,500 miles per year, and we also offer a high mileage plan with options as high as 30,000 miles per year.

SINGLE PAYMENT LEASE

A single payment lease provides convenience and savings. You make only one payment, one time, freeing you from monthly payments. It permits you to prepay all monthly payments in a single payment at lease signing. This single total lease payment is less than the amount you would pay over the term of a conventional lease.

MULTIPLE SECURITY DEPOSIT LEASE*

A multiple security deposit lease allows you to place a lump sum refundable security deposit at lease inception, which reduces your monthly rent charge, resulting in substantial savings over the term of the lease. The additional security deposits are refunded to you at the end of the lease term.

* Multiple Security Deposit Lease is not available in NY.

BUSINESS LEASE

Under our business lease option, owners have the flexibility to lease the vehicle as the business.

GUARANTEED AUTO PROTECTION (GAP) WAIVER

Our GAP Waiver is included in your lease agreement at no additional cost to you. It is provided to give you peace of mind. If your leased Volvo car is declared a total loss due to theft, accident, or natural disaster, we will cover the difference between the insurance proceeds and the balance owed to Volvo Car Financial Services less any deductible.

EXCESS WEAR AND USE PROTECTION PLAN **

As a part of everyday driving, normal wear and use can be expected. However, when turning in your leased vehicle, you may be responsible for any excess wear and use damage; therefore, Volvo Car Financial Services offers an optional plan to protect you and your car from unexpected occurrences that happen from nature and chance.

** Excess Wear and Use Protection Plan is optional and not available in AK, NM, NY, TX, UT and VT.

SPECIAL PROGRAMS

COLLEGE GRADUATE PROGRAM

You've worked hard to earn your degree. Now the Volvo Graduate Program can make it easy for you to drive a Volvo car. With flexible and competitive financing options available for graduates, Volvo Car Financial Services can help you to step into the luxury of driving a Volvo car with only a 5 percent down payment upon credit approval.

INTERNATIONAL STUDENT PROGRAM

The International Student Program is the easiest way to acquire a vehicle while studying in the US, only from Volvo. Instead of purchasing a car outright, make one easy, upfront payment and drive a brand new Volvo during your school term. After graduation, drop the car off at your local Volvo retailer. No hassles. You'll only pay for the portion of the car you use. It's as simple as that. Visit www.volvocarsforstudents.com for program details.

VOLVO MOBILITY PROGRAM

The goal of the Volvo Mobility Program is to assist persons with physical disabilities or hearing impairment. For those with exceptional transportation needs, this can be facilitated within the extraordinary comfort and safety of a specially adapted Volvo car. For additional information on this program, please contact **Mobility by Volvo Customer Care at 1-800-550-5658.**

PERSONAL SHOPPER

The Volvo Personal Shopper is dedicated to providing you with a whole new level of shopping convenience. Whether you'd like help identifying the Volvo model that best fits your lifestyle, detailed information on any Volvo model, or a comparison against the competition, Volvo is there to help. We can arrange a Guest Drive for you at your nearest Volvo Retailer.

So make the most of your shopping time and call the **Volvo Personal Shopper at 1-800-550-5658.**

SERVICE AND WARRANTY

VOLVO ROADSIDE ASSISTANCE

Whenever you need us, we're just a phone call away. Our nationwide network of retailers and authorized service providers are ready to assist. Whether you require roadside assistance or maps and routing information for your next trip, refer to your Volvo Roadside Assistance card and dial **1-800-63-VOLVO** at any time. Your complimentary four-year membership activates the moment you become a Volvo owner. A connection to Volvo Roadside Assistance/US is available through your App Store.

VOLVO NEW CAR WARRANTY

Your new-car warranty provides comprehensive coverage for four years or 50,000 miles, whichever occurs first. Additional warranties cover corrosion, seat belts, the supplemental restraint system, hybrid components, emission systems, genuine Volvo car replacement parts and genuine Volvo accessories. Should you encounter any problem with your Volvo car, simply contact the nearest retailer for assistance. Where your warranty ends, Volvo Increased Protection (VIP) plans begin. To purchase the additional protection of a VIP plan, contact your local retailer.

COMPLIMENTARY FACTORY SCHEDULED MAINTENANCE

Volvo Cars is committed to a premium ownership experience for its customers. To further enhance your ownership experience, all 2018 model year Volvo Cars sold in the United States will include Complimentary Factory Scheduled Maintenance. This program provides scheduled maintenance coverage for the first three years or 36,000 miles, whichever occurs first, and is designed to complement your Volvo warranty, helping ensure trouble-free operation of your Volvo. Coverage includes factory-recommended maintenance including oil and filter changes, checks and adjustments as listed in your Warranty and Maintenance Records Information booklet, for the first three maintenance services at intervals of 10,000, 20,000 and 30,000 miles.

Each service must be performed within 1,500 miles before or after each scheduled interval. Coverage is limited to scheduled maintenance items listed in the 2018 model year Warranty and Maintenance Records Information booklet. An authorized retailer must perform maintenance. Offer is transferable. Optional Prepaid Maintenance Plan upgrades are also available that will allow you to customize coverage to meet your driving needs. See your Volvo retailer for details.

FINANCE OPTIONS

Volvo Car Financial Services (VCFS) offers affordable and competitive financing on new and Volvo Certified Pre-Owned cars. Our low rates and flexible terms can get you behind the wheel of the Volvo you want to drive with finance terms up to 75 months. Volvo Car Financial Services also offers financing on vehicles purchased under the Overseas Delivery Program.

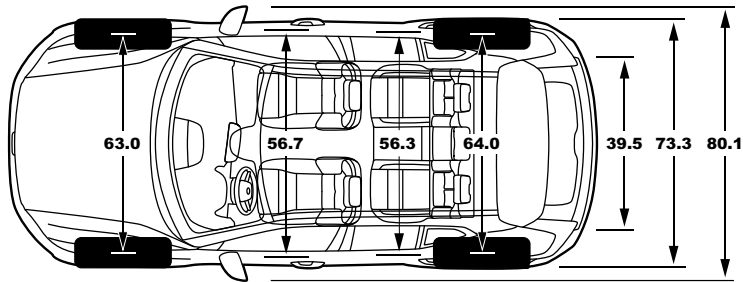
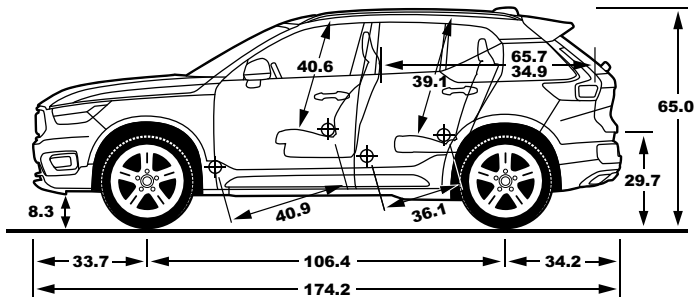
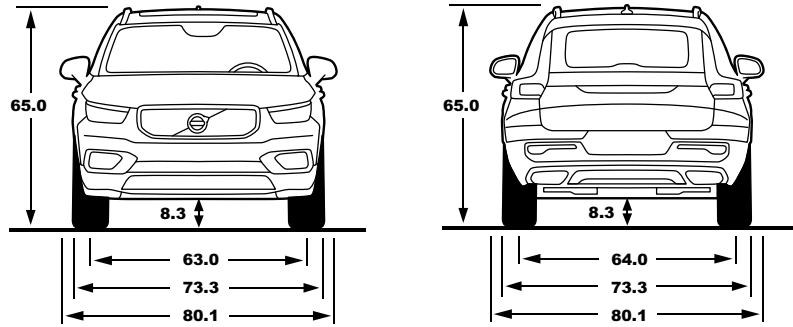

	T4 FWD	T5 AWD
Engine:	2.0L, Turbocharged	2.0L, Turbocharged
Horsepower at rpm:	187-hp @ 4,700 rpm	248-hp @ 5,500 rpm
Acceleration 0-60 mph:	8.1 sec	6.1 sec
Max Torque lb-ft at rpm:	221 lb-ft @ 1,400-4,000 rpm	258 lb-ft @ 1,800-4,800 rpm
Transmission:	8 - Speed Automatic Geartronic	8 - Speed Automatic Geartronic
Fuel Economy, City/Highway/Combined:	23 / 33 / 27	22 / 30 / 25
Fuel Tank Capacity:	14.2 Gallons	14.2 Gallons
Cargo Space, Max (cu ft):	57.5	57.5
Exterior Length/Width/Height including Shark Fin Antenna (inches):	174.2 / 80.1 / 65.3	174.2 / 80.1 / 65.3
Interior Headroom without Panoramic Moonroof (Front/Rear):	39.0 / 39.1	39.0 / 39.1
Interior Headroom with Panoramic Moonroof (Front/Rear):	37.6 / 38.3	37.6 / 38.3
Interior Legroom (Front/Rear):	40.9 / 36.1	40.9 / 36.1
Seating Capacity:	5	5

All technical data may be subject to change. Please talk to your Volvo dealer for the latest information.

Please note: Some of the information in this brochure may be incorrect due to changes in product specifications that may have occurred since printing. Some of the equipment described or shown may now only be available at extra cost. Before ordering, please ask your Volvo dealer for the latest information. The manufacturer reserves the right to make changes at any time and without notice to prices, colors, materials, specifications and models.

WELCOME TO VOLVO CAR LIFESTYLE COLLECTION.

Our Lifestyle Collection includes a wide range of lifestyle accessories – from Swedish crystal and crafted leather bags, to clothing, watches and more selected items. To view the complete collection, please visit volvocarcollectionus.com



ON SWEDISH TIME
Distinctive yet subtle, the first watch from Volvo Cars' design department – now available as part of the Volvo Car Lifestyle Collection – is an example of refined Scandinavian design.

TAKE YOUR MUSIC WITH YOU
These Harman/Kardon® Soho Wireless headphones combine sleek styling with exceptional sound quality. With Bluetooth® connectivity and a clever fold-flat design, they're perfect for enjoying your favorite music on the go.



TRAVEL IN STYLE
Designed by Volvo Cars and made by Swedish leather goods brand Sandqvist, our weekend bag and the matching leather card holder and leather travel wallet allow stylish traveling. Available in black and leather.

V O L V O

MODEL YEAR 2020 | VOLVOCARS.US

Specifications, features, and equipment shown in this catalog are based upon the latest information available at the time of publication. Some models are shown with European specifications. Volvo Car USA, LLC reserves the right to make changes at any time, without notice, to colors, specifications, accessories, and models. For additional information, please contact your authorized Volvo Cars retailer. © 2020 Volvo Car USA, LLC. **MY20**